

Congratulations! Your selection of a 2010 Acura RDX was a wise investment. It will give you years of driving pleasure.

One of the best ways to enhance the enjoyment of your new vehicle is to read this manual. In it, you will learn how to operate its driving controls and convenience items. Afterwards, keep this owner's manual in your vehicle so you can refer to it at any time.

Several warranties protect your new vehicle. Read the warranty booklet thoroughly so you understand the coverages and are aware of your rights and responsibilities.

Maintaining your vehicle according to the maintenance minder shown in the instrument panel helps to keep your driving trouble-free while it preserves your investment. When your vehicle needs maintenance, keep in mind that your dealer's staff is specially trained in servicing the many systems unique to your vehicle. Your dealer is dedicated to your satisfaction and will be pleased to answer any questions and concerns.

As you read this manual, you will find information that is preceded by a **NOTICE** symbol. This information is intended to help you avoid damage to your vehicle, other property, or the environment.

Introduction

California Proposition 65 Warning

WARNING: This product contains or emits chemicals known to the State of California to cause cancer and birth defects or other reproductive harm.

Event Data Recorders

This vehicle is equipped with one or more devices commonly referred to as event data recorders. These devices record front seat belt use, front passenger seat occupancy, airbag deployment data, and the failure of any airbag system component. This data belongs to the vehicle owner and may not be accessed by anyone else except as legally required or with the permission of the vehicle owner.

Service Diagnostic Recorders

This vehicle is equipped with service-related devices that record information about powertrain performance. The data can be used to verify emissions law requirements and/or help technicians diagnose and solve service problems. It may also be combined with data from other sources for research purposes, but it remains confidential.

Your safety, and the safety of others, is very important. And operating this vehicle safely is an important responsibility.

To help you make informed decisions about safety, we have provided operating procedures and other information on labels and in this manual. This information alerts you to potential hazards that could hurt you or others.

Of course, it is not practical or possible to warn you about all the hazards associated with operating or maintaining your vehicle. You must use your own good judgement.

You will find this important safety information in a variety of forms, including:

- **Safety Labels** – on the vehicle.
- **Safety Messages** – preceded by a safety alert symbol  and one of three signal words: **DANGER**, **WARNING**, or **CAUTION**.

These signal words mean:

 **DANGER**

You **WILL** be **KILLED** or **SERIOUSLY HURT** if you don't follow instructions.

 **WARNING**

You **CAN** be **KILLED** or **SERIOUSLY HURT** if you don't follow instructions.

 **CAUTION**

You **CAN** be **HURT** if you don't follow instructions.

- **Safety Headings** – such as Important Safety Reminders or Important Safety Precautions.
- **Safety Section** – such as Driver and Passenger Safety.
- **Instructions** – how to use this vehicle correctly and safely.

This entire book is filled with important safety information – please read it carefully.

Important Handling Information

Your RDX has higher ground clearance than a passenger vehicle designed for use only on pavement. Higher ground clearance has many advantages for off-highway driving. It allows you to travel over bumps, obstacles, and rough terrain. It also provides good visibility so you can anticipate problems earlier.

These advantages come at some cost. Because your vehicle is taller and rides higher off the ground, it has a high center of gravity. This means your vehicle can tip or roll over if you make abrupt turns. Utility vehicles have a significantly higher rollover rate than other types of vehicles. In a rollover crash, an unbelted person is significantly more likely to die than a person wearing a seat belt. As a reminder, make sure you and your passengers always wear seat belts.

For information on how to reduce the risk of rollover, read “Driving Guidelines” on page [372](#) of this manual and the *Off-Highway Driving Guidelines* section on page [405](#). Failure to operate your vehicle correctly might result in loss of control or an accident.

Owner's Identification Form

| | |
|--|------------|
| Your Vehicle at a Glance (main controls) | 3 |
| Driver and Passenger Safety (seat belts, SRS, and child protection) | 5 |
| Instruments and Controls (indicators, gauges, multi-information display, dashboard, and steering column) | 61 |
| Features (climate control, audio, steering wheel, security, cruise control, HomeLink®, and other convenience items) ... | 163 |
| Before Driving (fuel, vehicle break-in, and cargo loading) | 351 |
| Driving (engine and transmission operation) | 371 |
| Maintenance (minders, fluid checking, minor services, and vehicle storage) | 409 |
| Taking Care of the Unexpected (flat tire, jump starting, overheating, and fuses) | 453 |
| Technical Information (vehicle specifications, tires, and emissions controls) | 477 |
| Warranty and Client Relations (U.S. and Canada only) (warranty and contact information) | 493 |
| Index | I |

Service Information Summary (fluid capacities and tire pressures)

Overview of Contents

Contents

A convenient reference to the sections in this manual.

Your Vehicle at a Glance

A quick reference to the main controls in your vehicle.

Driver and Passenger Safety

Important information about the proper use and care of your vehicle's seat belts, an overview of the supplemental restraint system, and valuable information on how to protect children with child restraints.

Instruments and Controls

Explains the purpose of each instrument panel indicator and gauge, and how to use the controls on the dashboard and steering column.

Features

How to operate the climate control system, the audio system, and other convenience features.

Before Driving

What gasoline to use, how to break-in your new vehicle, and how to load luggage and other cargo.

Driving

The proper way to start the engine, shift the transmission, and park; plus what you need to know if you're planning to tow a trailer.

Maintenance

The maintenance minder shows you when you need to take your vehicle to the dealer for maintenance service. There is also a list of things to check and instructions on how to check them.

Taking Care of the Unexpected

This section covers several problems motorists sometimes experience, and details how to handle them.

Technical Information

ID numbers, dimensions, capacities, and technical information.

Warranty and Client Relations (U.S. and Canada only)

A summary of the warranties covering your new vehicle, and how to contact us for any reason. Refer to your warranty manual for detailed information.

Index

Service Information Summary

A summary of the information you need when you pull up to the fuel pump.

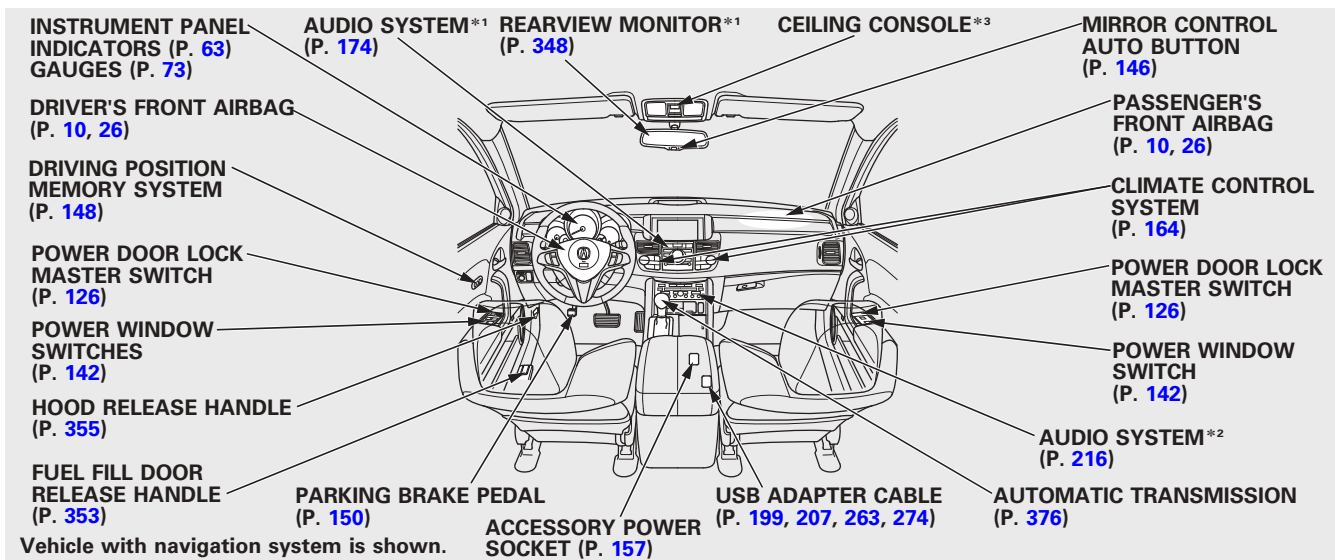

*1: On models without navigation system.

*2: On models with navigation system.

*3: HomeLink® buttons (P. 303)

Moonroof Switch (P. 144)

Front Ceiling Light Switch (P. 151)

CONTINUED

Your Vehicle at a Glance

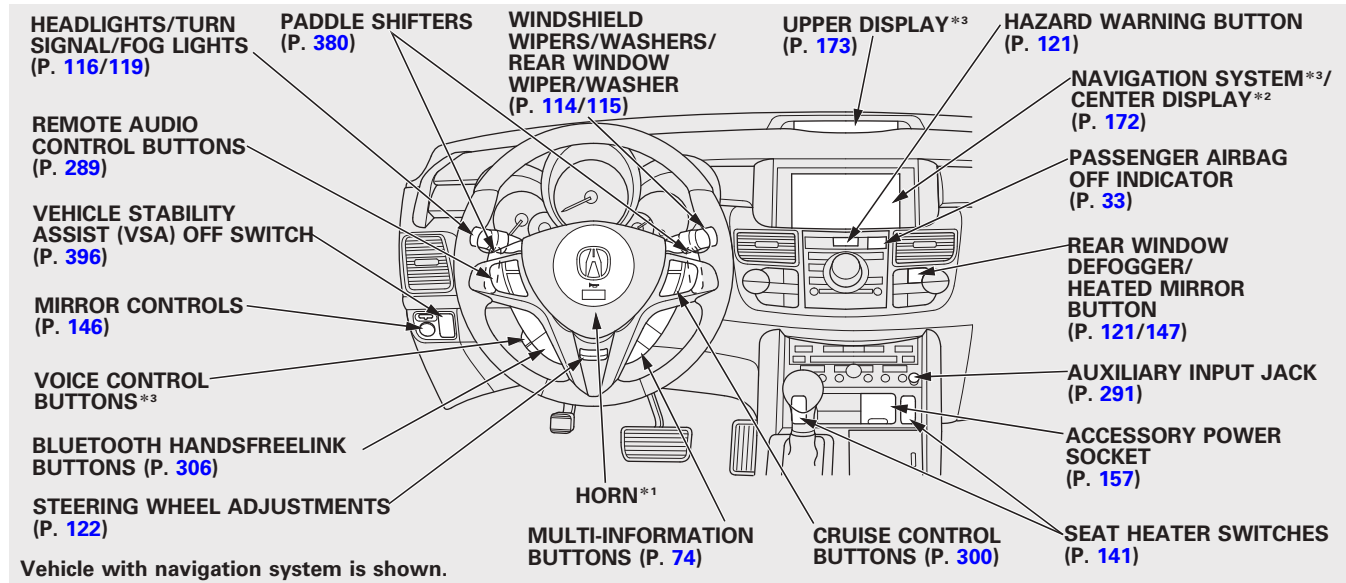

* 1: To use the horn, press the center pad of the steering wheel.

* 2: On models without navigation system.

* 3: Only on vehicles equipped with navigation system. Refer to the navigation system manual.

This section gives you important information about how to protect yourself and your passengers. It shows you how to use seat belts properly. It explains how your airbags work, and it tells you how to properly restrain infants and children in your vehicle.

| | |
|--|----|
| Important Safety Precautions..... | 6 |
| Your Vehicle's Safety Features | 8 |
| Seat Belts..... | 9 |
| Airbags | 10 |
| Protecting Adults and Teens | 12 |
| 1. Close and Lock the Doors..... | 12 |
| 2. Adjust the Front Seats | 13 |
| 3. Adjust the Seat-Backs..... | 14 |
| 4. Adjust the Head Restraints | 15 |
| 5. Fasten and Position the Seat Belts | 15 |
| 6. Maintain a Proper Sitting Position..... | 17 |
| Advice for Pregnant Women..... | 18 |
| Additional Safety Precautions | 19 |
| Additional Information About Your Seat Belts | 20 |
| Seat Belt System Components..... | 20 |

| | |
|--|----|
| Lap/Shoulder Belt..... | 21 |
| Automatic Seat Belt Tensioners | 22 |
| Seat Belt Maintenance | 23 |
| Additional Information About Your Airbags | 24 |
| Airbag System Components | 24 |
| How Your Front Airbags Work.... | 26 |
| How Your Side Airbags Work..... | 30 |
| How Your Side Curtain Airbags Work | 31 |
| How the SRS Indicator Works | 32 |
| How the Side Airbag Off Indicator Works | 32 |
| How the Passenger Airbag Off Indicator Works | 33 |
| Airbag Service | 34 |
| Additional Safety Precautions | 35 |
| Protecting Children – General Guidelines..... | 36 |
| All Children Must Be Restrained..... | 36 |
| All Children Should Sit in a Back Seat | 37 |
| The Passenger's Front Airbag Can Pose Serious Risks..... | 37 |

| | |
|---|----|
| If You Must Drive with Several Children | 39 |
| If a Child Requires Close Attention | 39 |
| Additional Safety Precautions | 40 |
| Protecting Infants and Small Children..... | 41 |
| Protecting Infants | 41 |
| Protecting Small Children | 42 |
| Selecting a Child Seat | 44 |
| Installing a Child Seat | 45 |
| Installing a Child Seat with LATCH | 46 |
| Installing a Child Seat with a Lap/Shoulder Belt..... | 50 |
| Installing a Child Seat with a Tether | 51 |
| Protecting Larger Children | 53 |
| Checking Seat Belt Fit | 53 |
| Using a Booster Seat..... | 54 |
| When Can a Larger Child Sit in Front | 55 |
| Additional Safety Precautions | 56 |
| Carbon Monoxide Hazard | 57 |
| Safety Labels..... | 58 |

Important Safety Precautions

You'll find many safety recommendations throughout this section, and throughout this manual. The recommendations on this page are the ones we consider to be the most important.

Always Wear Your Seat Belt

A seat belt is your best protection in all types of collisions. Airbags are designed to supplement seat belts, not replace them. So even though your vehicle is equipped with airbags, make sure you and your passengers always wear your seat belts, and wear them properly (see page 15).

Restrain All Children

Children age 12 and under should ride properly restrained in a back seat, not the front seat. Infants and small children should be restrained in a child seat. Larger children should use a booster seat and a lap/shoulder belt until they can use the belt properly without a booster seat (see pages 36 – 56).

Be Aware of Airbag Hazards

While airbags can save lives, they can cause serious or fatal injuries to occupants who sit too close to them, or are not properly restrained. Infants, young children, and short adults are at the greatest risk. Be sure to follow all instructions and warnings in this manual.

Don't Drink and Drive

Alcohol and driving don't mix. Even one drink can reduce your ability to respond to changing conditions, and your reaction time gets worse with every additional drink. So don't drink and drive, and don't let your friends drink and drive, either.

Important Safety Precautions

Pay Appropriate Attention to the Task of Driving Safely

Engaging in mobile phone conversation or other activities that keep you from paying close attention to the road, other vehicles and pedestrians could lead to a crash. Remember, situations can change quickly, and only you can decide when it is safe to divert attention away from driving.

Control Your Speed

Excessive speed is a major factor in crash injuries and deaths. Generally, the higher the speed, the greater the risk, but serious injuries can also occur at lower speeds. Never drive faster than is safe for current conditions, regardless of the maximum speed posted.

Keep Your Vehicle in Safe Condition

Having a tire blowout or a mechanical failure can be extremely hazardous. To reduce the possibility of such problems, check your tire pressures and condition frequently, and perform all regularly scheduled maintenance (see page [444](#)).

Your Vehicle's Safety Features

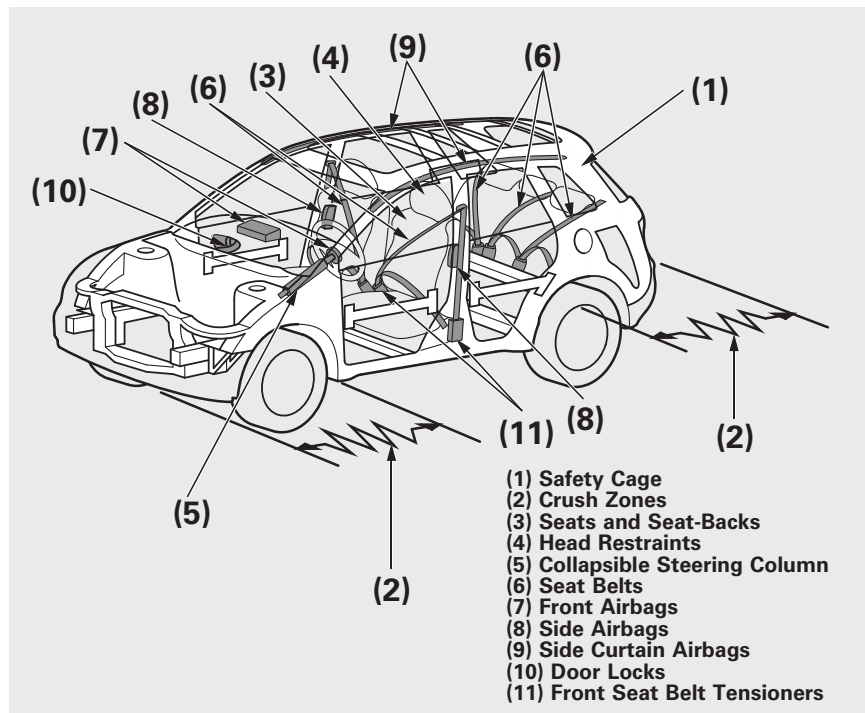

Your vehicle is equipped with many features that work together to protect you and your passengers during a crash.

Some features do not require any action on your part. These include a strong steel framework that forms a safety cage around the passenger compartment, front and rear crush zones, a collapsible steering column, and tensioners that tighten the front seat belts in a crash.

However, you and your passengers can't take full advantage of these features unless you remain sitting in the correct position and ***always wear your seat belts***. In fact, some safety features can contribute to injuries if they are not used properly.

The following pages explain how you can take an active role in protecting yourself and your passengers.

Your Vehicle's Safety Features

Seat Belts

Your vehicle is equipped with seat belts in all seating positions.

Your seat belt system also includes an indicator on the instrument panel and a beeper to remind you and your passengers to fasten your seat belts.

Why Wear Seat Belts

Seat belts are the single most effective safety device for adults and larger children. (Infants and smaller children must be properly restrained in child seats.)

Not wearing a seat belt properly increases the chance of serious injury or death in a crash, even though your vehicle has airbags.

In addition, most states and all Canadian provinces require you to wear seat belts.

▲ WARNING

Not wearing a seat belt properly increases the chance of serious injury or death in a crash, even though your vehicle has airbags.

Be sure you and your passengers always wear seat belts and wear them properly.

When properly worn, seat belts:

- Keep you connected to the vehicle so you can take advantage of the vehicle's built-in safety features.
- Help protect you in almost every type of crash, including:
 - frontal impacts
 - side impacts
 - rear impacts
 - rollovers

- Help keep you from being thrown against the inside of the vehicle and against other occupants.
- Keep you from being thrown out of the vehicle.
- Help keep you in a good position should the airbags ever deploy. A good position reduces the risk of injury from an inflating airbag and allows you to get the best advantage from the airbag.

Of course, seat belts cannot completely protect you in every crash. But in most cases, seat belts can reduce your risk of serious injury.

What You Should Do:

Always wear your seat belt, and make sure you wear it properly.

Your Vehicle's Safety Features

Airbags

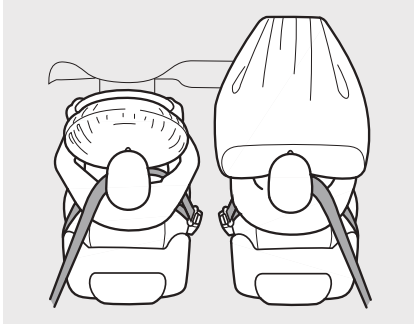

Your vehicle has a supplemental restraint system (SRS) with front airbags to help protect the heads and chests of the driver and a front seat passenger during a moderate to severe frontal collision (see page [26](#) for more information on how your front airbags work).

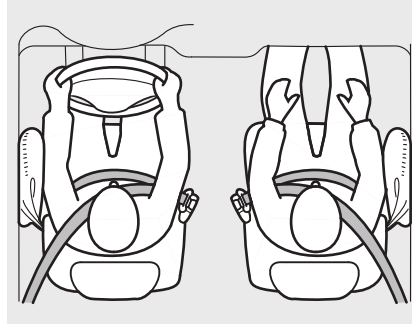

Your vehicle also has side airbags to help protect the upper torso of the driver or a front seat passenger during a moderate to severe side impact (see page [30](#) for more information on how your side airbags work).



In addition, your vehicle has side curtain airbags to help protect the heads of the driver, front passenger, and passengers in the outer rear seating positions during a moderate to severe side impact or rollover (see page [31](#) for more information on how your side curtain airbags work).

Your Vehicle's Safety Features

The most important things you need to know about your airbags are:

- ***Airbags do not replace seat belts.*** They are designed to supplement the seat belts.
- ***Airbags offer no protection in rear impacts, or minor frontal or side collisions.***
- ***Airbags can pose serious hazards.*** To do their job, airbags must inflate with tremendous force. So while airbags help save lives, they can cause minor injuries or more serious or even fatal injuries if occupants are not properly restrained or sitting properly.

What you should do: Always wear your seat belt properly, and sit upright and as far back from the steering wheel as possible while allowing full control of the vehicle. A front passenger should move their seat as far back from the dashboard as possible.

The rest of this section gives more detailed information about how you can maximize your safety.

Remember, however, that no safety system can prevent all injuries or deaths that can occur in a severe crash, even when seat belts are properly worn and the airbags deploy.

Protecting Adults and Teens

Introduction

The following pages provide instructions on how to properly protect the driver, adult passengers, and teenage children who are large enough and mature enough to drive or ride in the front.

See pages 36 – 56 for important guidelines on how to properly protect infants, small children, and larger children who ride in your vehicle.

1. Close and Lock the Doors

After everyone has entered the vehicle, be sure the doors and the tailgate are closed and locked.

Your vehicle has a door and tailgate open indicator on the multi-information display to indicate when a specific door or the tailgate is not tightly closed. You will see the appropriate indicator and the message for each condition.



When one or more doors are not tightly closed, the “DOOR OPEN” message will come on.

When the tailgate is not tightly closed, the “TAILGATE OPEN” message will come on.



When both tailgate and one or more doors are not tightly closed, the “DOOR & TAILGATE OPEN” message will come on.

You will also hear a beep when you turn the ignition switch to the ON (II) position, and each time you open any door or the tailgate with the key in the ON (II) position.

Locking the doors and the tailgate reduces the chance of someone being thrown out of the vehicle during a crash, and it helps prevent passengers from accidentally opening a door or the tailgate and falling out.

Locking the doors and the tailgate also helps prevent an outsider from unexpectedly opening a door or the tailgate when you come to a stop.

See page [126](#) for how to lock the doors and the tailgate.

This vehicle has auto door locking/unlocking features. See pages [103](#) and [111](#) for how to set them.

2. Adjust the Front Seats

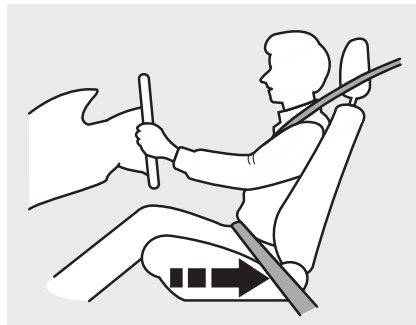

Adjust the driver's seat as far to the rear as possible while allowing you to maintain full control of the vehicle. Have a front passenger adjust their seat as far to the rear as possible.

If you sit too close to the steering wheel or dashboard, you can be seriously injured by an inflating front airbag, or by striking the steering wheel or dashboard.

The National Highway Traffic Safety Administration and Transport Canada recommend that drivers allow at least 10 inches (25 cm) between the center of the steering wheel and the chest. In addition to adjusting the seat, you can adjust the steering wheel up and down, and in and out (see page [122](#)).

If you cannot get far enough away from the steering wheel and still reach the controls, we recommend that you investigate whether some type of adaptive equipment may help.

CONTINUED

Protecting Adults and Teens

⚠ WARNING

Sitting too close to a front airbag can result in serious injury or death if the front airbags inflate.

Always sit as far back from the front airbags as possible.

See page [134](#) for how to adjust the front seats.

3. Adjust the Seat-Backs

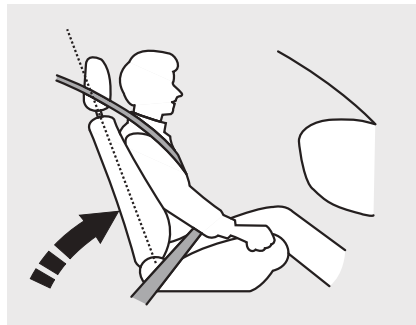

Adjust the driver's seat-back to a comfortable, upright position, leaving ample space between your chest and the airbag cover in the center of the steering wheel.

Passengers with adjustable seat-backs should also adjust their seat-back to a comfortable, upright position.

⚠ WARNING

Reclining the seat-back too far can result in serious injury or death in a crash.

Adjust the seat-back to an upright position, and sit well back in the seat.

Reclining a seat-back so that the shoulder part of the belt no longer rests against the occupant's chest reduces the protective capability of the belt. It also increases the chance of sliding under the belt in a crash and being seriously injured. The farther a seat-back is reclined, the greater the risk of injury.

See page [134](#) for how to adjust the seat-backs.

4. Adjust the Head Restraints

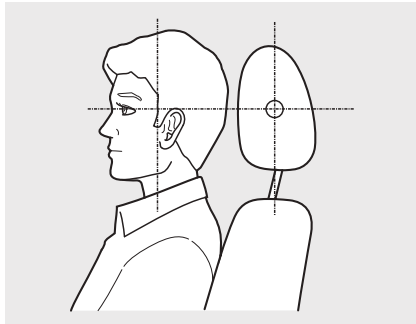

Adjust the driver's head restraint so the center of the back of your head rests against the center of the restraint.

Have passengers adjust their head restraints properly as well. Taller persons should adjust their restraint as high as possible.

⚠ WARNING

Improperly positioning head restraints reduces their effectiveness and you can be seriously injured in a crash.

Make sure head restraints are in place and positioned properly before driving.

Properly adjusted head restraints will help protect occupants from whiplash and other crash injuries.

See page [135](#) for how to adjust the head restraints and how the driver's and front passenger's active head restraints work.

5. Fasten and Position the Seat Belts

Insert the latch plate into the buckle, then tug on the belt to make sure the belt is securely latched. Check that the belt is not twisted, because a twisted belt can cause serious injuries in a crash.

CONTINUED

Protecting Adults and Teens



Position the lap part of the belt as low as possible across your hips, then pull up on the shoulder part of the belt so the lap part fits snugly. This lets your strong pelvic bones take the force of a crash and reduces the chance of internal injuries.

If necessary, pull up on the belt again to remove any slack, then check that the belt rests across the center of your chest and over your shoulder.

This spreads the forces of a crash over the strongest bones in your upper body.

⚠ WARNING

Improperly positioning the seat belts can cause serious injury or death in a crash.

Make sure all seat belts are properly positioned before driving.

If the seat belt touches or crosses your neck, or if it crosses your arm instead of your shoulder, you need to adjust the seat belt anchor height.



The front seats have adjustable seat belt anchors. To adjust the height of an anchor, press and hold the release button and slide the anchor up or down as needed (it has four positions).

Never place the shoulder portion of a lap/shoulder belt under your arm or behind your back. This could cause very serious injuries in a crash.

If a seat belt does not seem to work properly, it may not protect the occupant in a crash.

No one should sit in a seat with an inoperative seat belt. Using a seat belt that is not working properly can result in serious injury or death. Have your dealer check the belt as soon as possible.

See page 20 for additional information about your seat belts and how to take care of them.

6. Maintain a Proper Sitting Position

After all occupants have adjusted their seats and head restraints, and put on their seat belts, it is very important that they continue to sit upright, well back in their seats, with their feet on the floor, until the vehicle is parked and the engine is off.

Sitting improperly can increase the chance of injury during a crash. For example, if an occupant slouches, lies down, turns sideways, sits forward, leans forward or sideways, or puts one or both feet up, the chance of injury during a crash is greatly increased.

In addition, an occupant who is out of position in the front seat can be seriously or fatally injured in a crash by striking interior parts of the vehicle or being struck by an inflating front airbag.

⚠ WARNING

Sitting improperly or out of position can result in serious injury or death in a crash.

Always sit upright, well back in the seat, with your feet on the floor.

Protecting Adults and Teens

Advice for Pregnant Women



If you are pregnant, the best way to protect yourself and your unborn child when driving or riding in a vehicle is to always wear a seat belt, and keep the lap part of the belt as low as possible across the hips.

When driving, remember to sit upright and adjust the seat as far back as possible while allowing full control of the vehicle. When riding as a front passenger, adjust the seat as far back as possible.

This will reduce the risk of injuries to both you and your unborn child that can be caused by a crash or an inflating front airbag.

Each time you have a checkup, ask your doctor if it's okay for you to drive.

Additional Safety Precautions

- **Never let passengers ride in the cargo area or on top of a folded-down back seat.** If they do, they could be very seriously injured in a crash.
- **Passengers should not stand up or change seats while the vehicle is moving.** A passenger who is not wearing a seat belt during a crash or emergency stop can be thrown against the inside of the vehicle, against other occupants, or out of the vehicle.
- **Two people should never use the same seat belt.** If they do, they could be very seriously injured in a crash.
- **Do not put any accessories on seat belts.** Devices intended to improve occupant comfort or reposition the shoulder part of a seat belt can reduce the protective capability of the belt and increase the chance of serious injury in a crash.
- **Do not place hard or sharp objects between yourself and a front airbag.** Carrying hard or sharp objects on your lap, or driving with a pipe or other sharp object in your mouth, can result in injuries if your front airbag inflates.
- **Keep your hands and arms away from the airbag covers.** If your hands or arms are close to an airbag cover, they could be injured if the airbag inflates.
- **Do not attach or place objects on the front airbag covers.** Objects on the covers marked “SRS AIRBAG” could interfere with the proper operation of the airbags or be propelled inside the vehicle and hurt someone if the airbags inflate.
- **Do not attach hard objects on or near a door.** If a side airbag or a side curtain airbag inflates, a cup holder or other hard object attached on or near the door could be propelled inside the vehicle and hurt someone.
- **Do not cover or replace front seat-back covers without consulting your dealer.** Improperly replacing or covering front seat-back covers can prevent your side airbags from inflating during a side impact.

Additional Information About Your Seat Belts

Seat Belt System Components

Your seat belt system includes lap/shoulder belts in all seating positions. The front seat belts are also equipped with automatic seat belt tensioners.

This system uses the same sensors as the front airbags to monitor whether the front seat belts are latched or unlatched, and how much weight is on the front passenger's seat (see pages [28](#) and [29](#)).



The seat belt system includes an indicator on the instrument panel and a beeper to remind you and your passengers to fasten your seat belts.

This system monitors the front seat belts. If you turn the ignition switch to the ON (II) position before your seat belt is fastened, the beeper will sound and the indicator will flash. If your seat belt is not fastened before the beeper stops, the indicator will stop flashing but remain on.

If a front passenger does not fasten their seat belt, the indicator will come on about 6 seconds after the ignition switch is turned to the ON (II) position.

If either the driver or a front passenger does not fasten their seat belt while driving, the beeper will sound and the indicator will flash again at regular intervals.

In addition to the seat belt reminder indicator in the instrument panel, you will also see a “FASTEN SEAT BELT” or “FASTEN PASSENGER SEAT BELT” message. This remains displayed if you ignore it and do not fasten the seat belt while driving.

When no one is sitting in the front passenger's seat, or a child or small adult is riding there, the indicator should not come on and the beeper should not sound.

Additional Information About Your Seat Belts

If the indicator comes on or the beeper sounds when the driver's seat belt is latched and there is no front seat passenger and no items on the front seat, something may be interfering with the monitoring system. Look for and remove:

- Any items under the front passenger's seat.
- Any object(s) hanging on the seat or in the seat-back pocket.
- Any object(s) touching the rear of the seat-back.

If no obstructions are found, have your vehicle checked by a dealer.

Lap/Shoulder Belt

The lap/shoulder belt goes over your shoulder, across your chest, and across your hips.

To fasten the belt, insert the latch plate into the buckle, then tug on the belt to make sure the buckle is latched (see page 15 for how to properly position the belt).

To unlock the belt, press the red PRESS button on the buckle. Guide the belt across your body so that it retracts completely. After exiting the vehicle, be sure the belt is out of the way and will not get closed in the door.

All seat belts have an emergency locking retractor. In normal driving, the retractor lets you move freely in your seat while it keeps some tension on the belt. During a collision or sudden stop, the retractor automatically locks the belt to help restrain your body.

The seat belts in all positions except the driver's have a lockable retractor that must be activated to secure a child seat (see page 50).

CONTINUED

Additional Information About Your Seat Belts

If the shoulder part of the belt is pulled all the way out, the lockable retractor will activate. The belt will retract, but it will not allow the passenger to move freely.

To deactivate the lockable retractor, unlatch the buckle and let the seat belt fully retract. To refasten the seat belt, pull it out only as far as needed.

Automatic Seat Belt Tensioners

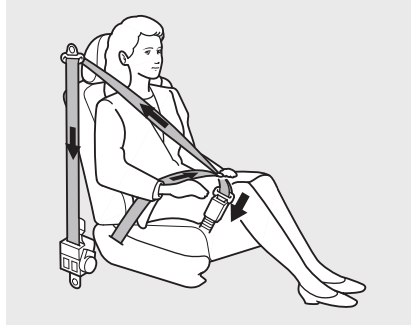

For added protection, the front seat belts are equipped with automatic seat belt tensioners. When activated, the tensioners immediately tighten the belts to help hold the driver and a front passenger in position.

The tensioners are designed to activate in any collision severe enough to cause the front airbags to deploy, or if a sensor detects your vehicle is about to roll over (see page [31](#)).

If a side curtain airbag deploys during a side impact, the tensioner on that side of the vehicle will also deploy.

The tensioners can also be activated during a collision in which the front airbags *do not deploy*. In this case, the airbags would not be needed, but the extra tension in the seat belt could be helpful.

When the tensioners are activated, the seat belts will remain tight until they are unbuckled.

Additional Information About Your Seat Belts

Seat Belt Maintenance

For safety, you should check the condition of your seat belts regularly.

Pull each belt out fully, and look for frays, cuts, burns, and wear. Check that the latches work smoothly and the belts retract easily. If a belt does not retract easily, cleaning the belt may correct the problem (see page 438). Any belt that is not in good condition or working properly will not provide good protection and should be replaced as soon as possible.

Acura provides a limited warranty on seat belts. See your *Acura Warranty Information* booklet for details.

If a seat belt is worn during a crash, it must be replaced by your dealer. A belt that has been worn during a crash may not provide the same level of protection in a subsequent crash.

The dealer should also inspect the anchors for damage and replace them if needed. If the automatic seat belt tensioners activate during a crash, they must be replaced.

WARNING

Not checking or maintaining seat belts can result in serious injury or death if the seat belts do not work properly when needed.

Check your seat belts regularly and have any problem corrected as soon as possible.

Additional Information About Your Airbags

Airbag System Components

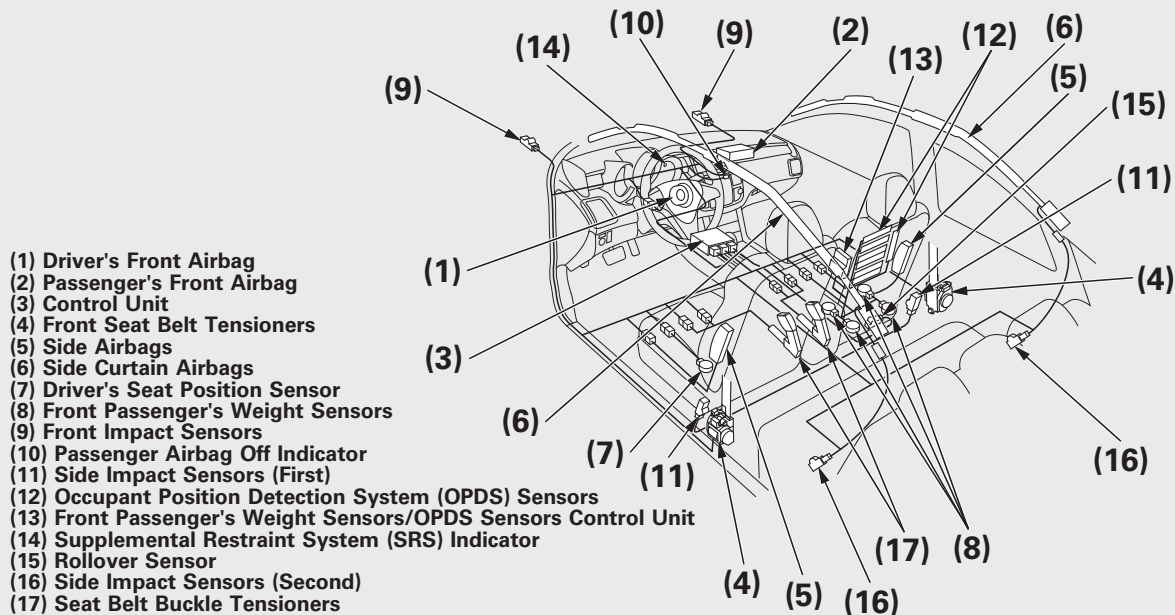

Additional Information About Your Airbags

Your airbag system includes:

- Two SRS (supplemental restraint system) front airbags. The driver's airbag is stored in the center of the steering wheel; the front passenger's airbag is stored in the dashboard. Both are marked "SRS AIRBAG" (see page 26).
- Two side airbags, one for the driver and one for a front passenger. The airbags are stored in the outer edges of the seat-backs. Both are marked "SIDE AIRBAG" (see page 30).
- Two side curtain airbags, one for each side of the vehicle. The airbags are stored in the ceiling, above the side windows. The front and rear pillars are marked "SIDE CURTAIN AIRBAG" (see page 31).
- Automatic front seat belt tensioners (see page 22).
- Sensors that can detect a moderate to severe front impact, side impact, or rollover.
- Sensors that can detect whether a child is in the passenger's side airbag path and signal the control unit to turn the airbag off (see page 30).
- Sensors that can detect whether the driver's seat belt and the front passenger's seat belt are latched or unlatched (see page 20).
- A driver's seat position sensor that monitors the distance of the seat from the front airbag. If the seat is too far forward, the airbag will inflate with less force (see page 28).
- Weight sensors that monitor the weight on the front passenger's seat. If the weight is about 65 lbs (29 kg) or less (the weight of an infant or small child), the passenger's front airbag will be turned off (see page 28).
- A rollover sensor that can detect if your vehicle is about to roll over and signal the control unit to deploy both side curtain airbags and front seat belt tensioners (see page 31).
- A sophisticated electronic system that continually monitors and records information about the sensors, the control unit, the airbag activators, the seat belt tensioners, and driver and front passenger seat belt use when the ignition switch is in the ON (II) position.

CONTINUED

Additional Information About Your Airbags

- An indicator on the instrument panel that alerts you to a possible problem with your airbags, sensors, or seat belt tensioners (see page [32](#)).
- An indicator on the instrument panel that alerts you that the passenger's side airbag has been turned off (see page [32](#)).
- An indicator on the dashboard that alerts you that the passenger's front airbag has been turned off (see page [33](#)).
- Emergency backup power in case your vehicle's electrical system is disconnected in a crash.

How Your Front Airbags Work

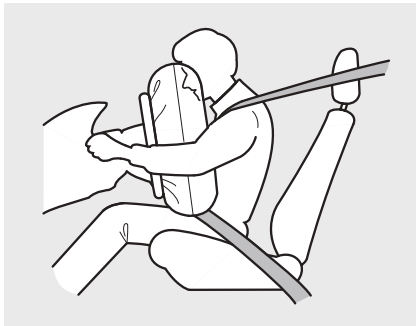

If you ever have a moderate to severe frontal collision, sensors will detect the vehicle's rapid deceleration.

If the rate of deceleration is high enough, the control unit will inflate the driver's and front passenger's airbags, at the time and with the force needed.

During a frontal crash, your seat belt restrains your lower body and torso, and the front airbag helps protect your head and chest.

Although both airbags normally inflate within a split second of each other, it is possible for only one airbag to deploy.

This can happen if the severity of a collision is at the margin, or threshold, that determines whether or not the airbags will deploy. In such cases, the seat belt will provide sufficient protection, and the supplemental protection offered by the airbag would be minimal.

Only the driver's airbag will deploy if there is no passenger in the front seat, or if the advanced airbag system has turned the passenger's airbag off (see page [33](#)).

Additional Information About Your Airbags

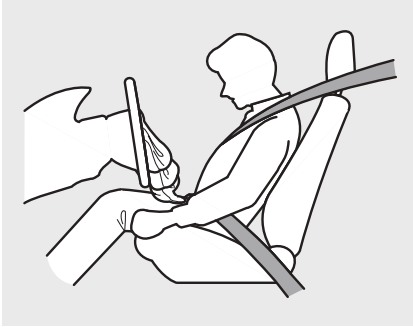

After inflating, the front airbags immediately deflate, so they won't interfere with the driver's visibility, or the ability to steer or operate other controls.

The total time for inflation and deflation is one-tenth of a second, so fast that most occupants are not aware that the airbags deployed until they see them lying in their laps.

After a crash, you may see what looks like smoke. This is actually powder from the airbag's surface. Although the powder is not harmful, people with respiratory problems may experience some temporary discomfort. If this occurs, get out of the vehicle as soon as it is safe to do so.

Dual-Stage Airbags

Your front airbags are dual-stage airbags. This means they have two inflation stages that can be ignited sequentially or simultaneously, depending on crash severity.

In a **more severe** crash, both stages will ignite simultaneously to provide the quickest and greatest protection.

In a **less severe** crash, one stage will ignite first, then the second stage will ignite a split second later. This provides longer airbag inflation time with a little less force.

CONTINUED

Additional Information About Your Airbags

Dual-Threshold Airbags

Your front airbags are also dual-threshold airbags. Airbags with this feature have two deployment thresholds that depend on whether sensors detect the occupant is wearing a seat belt or not.

If the occupant's belt is **not latched**, the airbag will deploy at a slightly lower threshold, because the occupant would need extra protection.

If the occupant's belt is **latched**, the airbag will inflate at a slightly higher threshold, when the airbag would be needed to supplement the protection provided by the seat belt.

Advanced Airbags

Your front airbags are also advanced airbags. The main purpose of this feature is to help prevent airbag-caused injuries to children or small statured adults who ride in front.

For both advanced airbags to work properly:

- Occupants must sit upright and wear their seat belts properly.
- Do not spill any liquids on or under the seats, cover the sensors, or put any cargo or metal objects under the front seats.

Failure to follow these instructions could damage the sensors or prevent them from working properly.

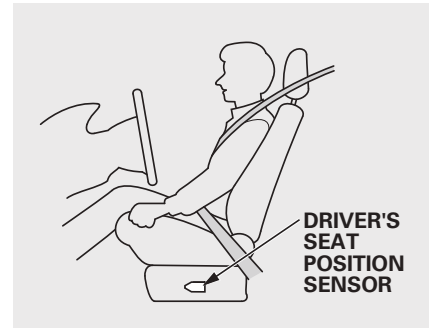

The driver's advanced front airbag system includes a seat position sensor under the seat. If the seat is too far forward, the airbag will inflate with less force, regardless of the severity of the impact.

If there is a problem with the sensor, the SRS indicator will come on, and the airbag will inflate in the normal manner regardless of the driver's seating position.

Additional Information About Your Airbags

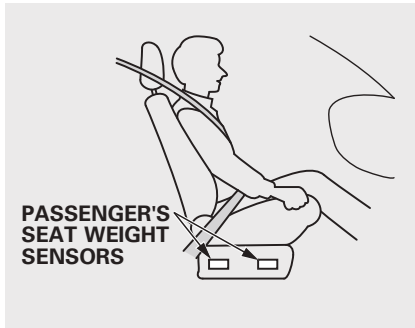

The passenger's advanced front airbag system has weight sensors under the seat. Although Acura does not encourage carrying an infant or small child in front, if the sensors detect the weight of an infant or small child (up to about 65 lbs or 29 kg), the system will automatically turn the passenger's front airbag off.

Be aware that objects placed on the passenger's seat can also cause the airbag to be turned off.

When the passenger airbag gets turned off by the weight sensors, a "passenger airbag off" indicator in the center of the dashboard comes on (see page 33).

If the weight sensors detect there is no passenger in the front seat, the airbag is automatically turned off. However, the passenger airbag off indicator in this situation will not come on.

To ensure that the passenger's advanced front airbag system will work properly, ***do not do anything that would increase or decrease the weight on the front passenger's seat.*** This includes:

- A rear passenger pushing or pulling on the back of the front passenger's seat.

- Moving the front seat forcibly back against cargo on the seat or floor behind it.
- Hanging heavy items on the front passenger seat, or placing heavy items in the seat-back pocket.
- Moving the front seat or seat-back forcibly back against the folded rear seat.
- Back seat passengers should not wedge objects or intentionally force their feet under the front passenger seat.

Also, make sure the floor mat behind the front passenger's seat is properly positioned on the floor (see page 438). If it is not, the mat may interfere with the proper operation of the front passenger's seat and its sensors.

Additional Information About Your Airbags

How Your Side Airbags Work

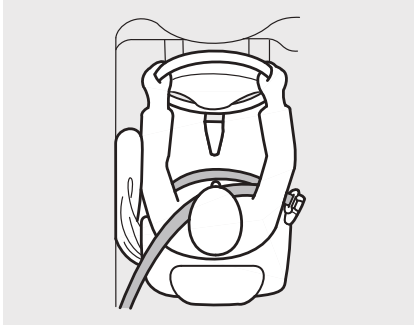

If you ever have a moderate to severe side impact, sensors will detect rapid acceleration and signal the control unit to instantly inflate either the driver's or the passenger's side airbag.

Only one airbag will deploy during a side impact. If the impact is on the passenger's side, the passenger's side airbag will deploy even if there is no passenger.

To get the best protection from the side airbags, front seat occupants should wear their seat belts and sit upright and well back in their seats.

Side Airbag Cutoff System

Your vehicle has a side airbag cutoff system designed primarily to protect a child riding in the front passenger's seat.

Although Acura does not encourage children to ride in front, if the position sensors detect a child has leaned into the side airbag's deployment path, the airbag will shut off.

The side airbag may also shut off if a short adult leans sideways, or a larger adult slouches and leans sideways into the airbag's deployment path.

Objects placed on the front passenger seat can also cause the side airbag to be shut off.

Additional Information About Your Airbags

If the side airbag off indicator comes on (see page 32), have the passenger sit upright. Once the passenger is out of the airbag's deployment path, the system will turn the airbag back on, and the indicator will go out.

There will be some delay between the moment the passenger moves into or out of the airbag deployment path and when the indicator comes on or goes off.

A front seat passenger should not use a cushion or other object as a backrest. It may prevent the cutoff system from working properly.

How Your Side Curtain Airbags Work

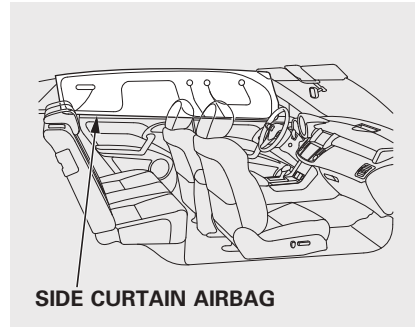

In a Side Impact

In a moderate to severe side impact, sensors will detect rapid acceleration and signal the control unit to instantly inflate the side curtain airbag and activate the seat belt tensioner on the driver's or the passenger's side of the vehicle.

If the impact is on the passenger's side, the passenger's side curtain airbag will inflate even if there are no occupants on that side of the vehicle.

In a Rollover

If the rollover sensor detects your vehicle is about to roll over, it signals the control unit, which immediately deploys both side curtain airbags and activates both front seat belt tensioners.

The airbag on the passenger's side will deploy, and the seat belt tensioner will activate, even if there are no passengers on that side of the vehicle.

To get the best protection from the side curtain airbags, occupants should wear their seat belts and sit upright and well back in their seats.

Additional Information About Your Airbags

How the SRS Indicator Works



The SRS indicator alerts you to a potential problem with your airbags or seat belt tensioners.

When you turn the ignition switch to the ON (II) position, this indicator comes on for several seconds then goes off. This tells you the system is working properly.

If the indicator comes on at any other time, or does not come on at all, you should have the system checked by your dealer. For example:

- If the SRS indicator does not come on after you turn the ignition switch to the ON (II) position.
- If the indicator stays on after the engine starts.
- If the indicator comes on or flashes on and off while you drive.

You will also see a “CHECK AIRBAG SYSTEM” message on the multi-information display (see page 80).

If you see any of these indications, the airbags and seat belt tensioners may not work properly when you need them.

⚠ WARNING

Ignoring the SRS indicator can result in serious injury or death if the airbag systems or tensioners do not work properly.

Have your vehicle checked by a dealer as soon as possible if the SRS indicator alerts you to a possible problem.

How the Side Airbag Off Indicator Works

U.S.

Canada



This indicator alerts you that the passenger's side airbag has been automatically shut off. It does *not* mean there is a problem with your side airbags.

When you turn the ignition switch to the ON (II) position, the indicator should come on for several seconds and then go off (see page 66). If it doesn't come on, stays on, or comes on while driving without a passenger in the front seat, have the system checked.

You will also see a “PASSENGER SIDE AIRBAG OFF” message on the multi-information display (see page 80).

Additional Information About Your Airbags

How the Passenger Airbag Off Indicator Works

PASSENGER AIRBAG OFF INDICATOR

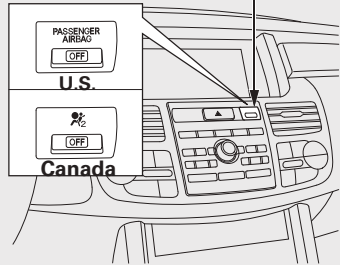

This indicator alerts you that the passenger's front airbag has been shut off because weight sensors detect about 65 lbs (29 kg) or less (the weight of an infant or small child) on the front passenger's seat. It does **not mean** there is a problem with the airbag.

Be aware that objects placed on the front seat can cause the indicator to come on.

If no weight is detected on the front seat, the airbag will be automatically shut off. However, the indicator will not come on.

The passenger airbag off indicator may come on and off repeatedly if the total weight on the seat is near the airbag cutoff threshold.

If an adult or teenage passenger is riding in front, move the seat as far to the rear as possible, and have the passenger sit upright and wear the seat belt properly.

If the indicator comes on with no front seat passenger and no objects on the seat, or with an adult riding there, something may be interfering with the weight sensors. Look for and remove:

- Any items under the front passenger's seat.
- Any object(s) hanging on the seat or in the seat-back pocket.
- Any object(s), such as a folded-down back seat, that are touching the rear of the seat-back.

If no obstructions are found, have your vehicle checked by a dealer as soon as possible.

Additional Information About Your Airbags

Airbag Service

Your airbag systems are virtually maintenance free, and there are no parts you can safely service.

However, you must have your vehicle serviced if:

- ***An airbag ever inflates.*** Any airbag that has deployed must be replaced along with the control unit and other related parts. Any seat belt tensioner that activates must also be replaced.

Do not try to remove or replace any airbag by yourself. This must be done by an authorized dealer or a knowledgeable body shop.

- ***The SRS indicator alerts you to a problem.*** Take your vehicle to an authorized dealer as soon as possible. If you ignore this indication, your airbags may not operate properly.
- ***If your vehicle has a moderate to severe impact.*** Even if your airbags do not inflate, your dealer should inspect the driver's seat position sensor, the front passenger's weight sensors, the front seat belt tensioners, and all seat belts and their anchor worn during a crash to make sure they are operating properly.

Additional Information About Your Airbags

Additional Safety Precautions

- **Do not attempt to deactivate your airbags.** Together, airbags and seat belts provide the best protection.
- **Do not tamper with airbag components or wiring for any reason.** Tampering could cause the airbags to deploy, possibly causing very serious injury.
- **Do not expose the front passenger's seat-back to liquid.** If water or another liquid soaks into a seat-back, it can prevent the side airbag cutoff system from working properly.
- **Do not remove or modify a front seat without consulting your dealer.** This could make the driver's seat position sensor or the front passenger's weight sensors ineffective. If it is necessary to remove or modify a front seat to accommodate a person with disabilities, first contact Acura Client Services at 800-382-2238.

Protecting Children – General Guidelines



Children depend on adults to protect them. However, despite their best intentions, many adults do not know how to *properly* protect child passengers.

If you have children, or ever need to drive with a child in your vehicle, be sure to read this section. It begins with important general guidelines, then presents special information for infants, small children, and larger children.

All Children Must Be Restrained

Each year, many children are injured or killed in vehicle crashes because they are either unrestrained or not properly restrained. In fact, vehicle accidents are the number one cause of the death of children aged 12 and under.

To reduce the number of child deaths and injuries, every state, Canadian province and territory requires that infants and children be properly restrained when they ride in a vehicle.

Infants and small children must be restrained in an approved child seat that is properly secured to the vehicle (see pages 41 – 52).

▲ WARNING

Children who are unrestrained or improperly restrained can be seriously injured or killed in a crash.

Any child too small for a seat belt should be properly restrained in a child seat. A larger child should be properly restrained with a seat belt and use a booster seat if necessary.

Larger children must be restrained with a lap/shoulder belt and ride on a booster seat until the seat belt fits them properly (see pages 53 – 56).

All Children Should Sit in a Back Seat

According to accident statistics, children of all ages and sizes are safer when they are restrained in a back seat.

The National Highway Traffic Safety Administration and Transport Canada recommend that all children aged 12 and under be properly restrained in a back seat. Some states have laws restricting where children may ride.

Children who ride in back are less likely to be injured by striking interior vehicle parts during a collision or hard braking. Also, children cannot be injured by an inflating front airbag when they ride in the back.

The Passenger's Front Airbag Can Pose Serious Risks

Front airbags have been designed to help protect adults in a moderate to severe frontal collision. To do this, the passenger's front airbag is quite large, and it can inflate with enough force to cause very serious injuries.

Even though your vehicle has an advanced front airbag system that automatically turns the passenger's front airbag off under certain circumstances (see page 33), please follow these guidelines:

Infants

Never put a rear-facing child seat in the front seat of a vehicle equipped with a passenger's front airbag. If the airbag inflates, it can hit the back of the child seat with enough force to kill or very seriously injure an infant.

Small Children

Placing a forward-facing child seat in the front seat of a vehicle equipped with a passenger's front airbag can be hazardous. If the vehicle seat is too far forward, or the child's head is thrown forward during a collision, an inflating front airbag can strike the child with enough force to kill or very seriously injure a small child.

Larger Children

Children who have outgrown child seats are also at risk of being injured or killed by an inflating passenger's front airbag. Whenever possible, larger children should sit in the back seat, on a booster seat if needed, and be properly restrained with a seat belt (see page 53 for important information about protecting larger children).

CONTINUED

Protecting Children – General Guidelines

To remind you of the passenger's front airbag hazards, and that children must be properly restrained in a back seat, your vehicle has warning labels on the dashboard (U.S. models) and on the front visors. Please read and follow the instructions on these labels.

U.S. Models

SUN VISORS



Canadian Models

SUN VISORS

CAUTION

TO AVOID SERIOUS INJURY:

- FOR MAXIMUM SAFETY PROTECTION IN ALL TYPES OF CRASHES, YOU MUST ALWAYS WEAR YOUR SAFETY BELT.
- DO NOT INSTALL REARWARD-FACING CHILD SEATS IN ANY FRONT PASSENGER SEAT POSITION.
- DO NOT SIT OR LEAN UNNECESSARILY CLOSE TO THE AIR BAG.
- DO NOT PLACE ANY OBJECTS OVER THE AIR BAG OR BETWEEN THE AIR BAG AND YOURSELF.
- SEE THE OWNER'S MANUAL FOR FURTHER INFORMATION AND EXPLANATIONS.

DASHBOARD

This Vehicle is Equipped with
Advanced Air Bags

Even with Advanced Air Bags

Children can be killed or seriously injured by the air bag. The back seat is the safest place for children. Never put a rear-facing child seat in the front. Always use seat belts and child restraints. See owner's manual for more information about air bags.

To be removed by owner only.

PRÉCAUTION:

POUR ÉVITER DES BLESSURES GRAVES:

- POUR PROFITER D'UNE PROTECTION MAXIMALE LORS D'UNE COLLISION BOUCLEZ TOUJOURS VOTRE CEINTURE DE SÉCURITÉ.
- N'INSTALLEZ JAMAIS UN SIÈGE POUR ENFANTS FAISANT FACE À L'ARRIÈRE SUR LE SIÈGE DU PASSAGER AVANT.
- NE VOUS APPUYEZ PAS ET NE VOUS ASSOYEZ PAS PRES DU COUSSIN GONFLABLE.
- NE DEPOSEZ AUCUN OBJET SUR LE COUSSIN GONFLABLE OU ENTRE LE COUSSIN GONFLABLE ET VOUS.
- LISEZ LE GUIDE UTILISATEUR POUR DE PLUS AMPLES RENSEIGNEMENTS.

If You Must Drive with Several Children

Your vehicle has a back seat where children can be properly restrained. If you ever have to carry a group of children, and a child must ride in front:

- Place the largest child in the front seat, provided the child is large enough to wear the lap/shoulder belt properly (see page [53](#)).
- Move the vehicle seat as far to the rear as possible (see page [134](#)).
- Have the child sit upright and well back in the seat (see page [17](#)).
- Make sure the seat belt is properly positioned and secured (see page [15](#)).

If a Child Requires Close Attention

Many parents say they prefer to put an infant or a small child in the front passenger seat so they can watch the child, or because the child requires attention.

Placing a child in the front seat exposes the child to hazards in a frontal collision, and paying close attention to a child distracts the driver from the important tasks of driving, placing both of you at risk.

If a child requires close physical attention or frequent visual contact, we strongly recommend that another adult ride with the child in a back seat. The back seat is far safer for a child than the front.

Protecting Children – General Guidelines

Additional Safety Precautions

- **Never hold an infant or child on your lap.** If you are not wearing a seat belt in a crash, you could be thrown forward and crush the child against the dashboard or a seat-back. If you are wearing a seat belt, the child can be torn from your arms and be seriously hurt or killed.
- **Never put a seat belt over yourself or a child.** During a crash, the belt could press deep into the child and cause serious or fatal injuries.
- **Never let two children use the same seat belt.** If they do, they could be very seriously injured in a crash.
- **Use the childproof door locks to prevent children from opening the rear doors.** This can prevent children from accidentally falling out (see page [127](#)).

- **Make sure any unused seat belt that a child can reach is buckled, the lockable retractor is activated, and the belt is fully retracted and locked.** If a child wraps a loose seat belt around their neck, they can be seriously or fatally injured. (See pages [50](#) and [51](#) for how to activate and deactivate the lockable retractor.)
- **Do not leave children alone in a vehicle.** Leaving children without adult supervision is illegal in most states, Canadian provinces/territories and can be very hazardous.

For example, infants and small children left in a vehicle on a hot day can die from heatstroke. A child left alone with the key in the ignition switch can accidentally set the vehicle in motion, possibly injuring themselves or others.

- **Lock all doors and the tailgate when your vehicle is not in use.** Children who play in vehicles can accidentally get trapped inside. Teach your children not to play in or around vehicles.
- **Keep vehicle keys/remote transmitters out of the reach of children.** Even very young children learn how to unlock vehicle doors, turn on the ignition switch, and open the tailgate, which can lead to accidental injury or death.

Protecting Infants

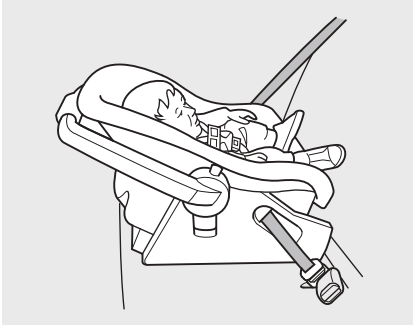

Child Seat Type

An infant must be properly restrained in a rear-facing, reclining child seat until the child reaches the seat maker's weight or height limit for the seat, and the child is at least one year old.

Only a rear-facing child seat provides proper support for a baby's head, neck, and back.

Two types of seats may be used: a seat designed exclusively for infants, or a convertible seat used in the rear-facing, reclining mode.

Do not put a rear-facing child seat in a forward-facing position. If placed facing forward, an infant could be very seriously injured during a frontal collision.

Rear-facing Child Seat Placement

A rear-facing child seat can be placed in any seating position in the back seat, but not in the front. ***Never put a rear-facing child seat in the front seat.***

If the passenger's front airbag inflates, it can hit the back of the child seat with enough force to kill or seriously injure an infant.

When properly installed, a rear-facing child seat may prevent the driver or a front passenger from moving their seat as far back as recommended, or from locking their seat-back in the desired position.

It could also interfere with proper operation of the passenger's advanced front airbag system.

CONTINUED

Protecting Infants and Small Children

In any of these situations, we strongly recommend that you install the child seat directly behind the front passenger's seat, move the seat as far forward as needed, and leave it unoccupied. Or, you may wish to get a smaller rear-facing child seat.

⚠ WARNING

Placing a rear-facing child seat in the front seat can result in serious injury or death during a collision.

Always place a rear-facing child seat in the back seat, not the front.

Protecting Small Children



Child Seat Type

Many states, Canadian provinces and territories allow a child one year of age or older who also meets the minimum size and weight requirements to transition from a rear-facing child seat to a forward facing seat. Know the requirements where you are driving and follow the child seat instructions. Many experts recommend use of a rear-facing seat up to age two, if the child's height and weight are appropriate for a rear-facing seat.

Of the different seats available, we recommend those that have a five-point harness system as shown.

We also recommend that a small child use the child seat until the child reaches the weight or height limit for the seat.

Child Seat Placement

We strongly recommend placing a forward-facing child seat in a back seat, not the front.

Placing a forward-facing child seat in the front seat of a vehicle equipped with a passenger's airbag can be hazardous. If the vehicle seat is too far forward, or the child's head is thrown forward during a collision, an inflating airbag can strike the child with enough force to cause very serious or fatal injuries.

Even with advanced front airbags that automatically turn the passenger's front airbag off (see page 33), a back seat is the safest place for a small child.

If it is necessary to put a forward-facing child seat in the front, move the vehicle seat as far to the rear as possible, and be sure the child seat is firmly secured to the vehicle and the child is properly strapped in the seat.

▲ WARNING

Placing a forward-facing child seat in the front seat can result in serious injury or death if the front airbag inflates.

If you must place a forward-facing child seat in front, move the vehicle seat as far back as possible, and properly restrain the child.

Selecting a Child Seat

When buying a child seat, you need to choose either a conventional child seat, or one designed for use with the Lower Anchors and Tethers for Children (LATCH) system.

Conventional child seats must be secured to a vehicle with a seat belt, whereas LATCH-compatible seats are secured by attaching the seat to hardware built into the rear seating positions.

Since LATCH-compatible child seats are easier to install and reduce the possibility of improper installation, we recommend selecting this style.

In seating positions and vehicles not equipped with LATCH, a LATCH-compatible child seat can be installed using a seat belt.

Whatever type of seat you choose, to provide proper protection, a child seat should meet three requirements:

1. ***The child seat should meet Federal Motor Vehicle Safety Standard 213 or Canadian Motor Vehicle Safety Standard 213.*** Look for FMVSS 213 or CMVSS 213 on the box.
2. ***The child seat should be of the proper type and size to fit the child.*** Rear-facing for infants, forward-facing for small children.
3. ***The child seat should fit the vehicle seating position (or positions) where it will be used.***

Before purchasing a conventional child seat, or using a previously purchased one, we recommend that you test the seat in the specific vehicle seating position or positions where the seat will be used.

After selecting a proper child seat and a good place to install the seat, there are three main steps in installing the seat:

1. ***Properly secure the child seat to the vehicle.*** All child seats must be secured to the vehicle with the lap part of a lap/shoulder belt or with the LATCH (Lower Anchors and Tethers for CHildren) system. A child whose seat is not properly secured to the vehicle can be endangered in a crash.
2. ***Make sure the child seat is firmly secured.*** After installing a child seat, push and pull the seat forward and from side-to-side to verify that it is secure.

A child seat secured with a seat belt should be installed as firmly as possible. However, it does not need to be “rock solid.” Some side-to-side movement can be expected and should not reduce the child seat's effectiveness.

If the child seat is not secure, try installing it in a different seating position, or use a different style of child seat that can be firmly secured.

3. ***Secure the child in the child seat.*** Make sure the child is properly strapped in the child seat according to the child seat maker's instructions. A child who is not properly secured in a child seat can be seriously injured in a crash.

The following pages provide guidelines on how to properly install a child seat. A forward-facing child seat is used in all examples, but the instructions are the same for rear-facing child seats.

Installing a Child Seat

Installing a Child Seat with LATCH

Your vehicle is equipped with LATCH (Lower Anchors and Tethers for CHildren) at the rear seats to secure a child seat in any seating position: one in each outer seating position, or one in the center.

The five lower anchors are located between the seat-back and seat bottom, and are to be used only with a child seat designed for use with LATCH.

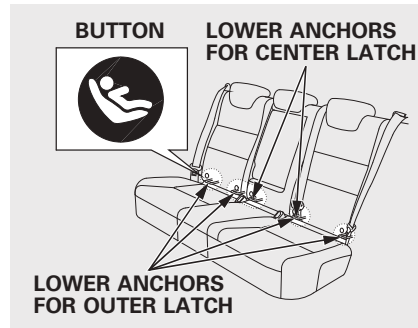

The location of each lower anchor is indicated by a small button above the anchor point.

When you install a child seat in the rear center seating position, use the center LATCH as shown in the illustration. To install a child seat in the outer seating position, use either LATCH. You can install up to two child seat at a time with outer LATCH.

Using the Outer LATCH

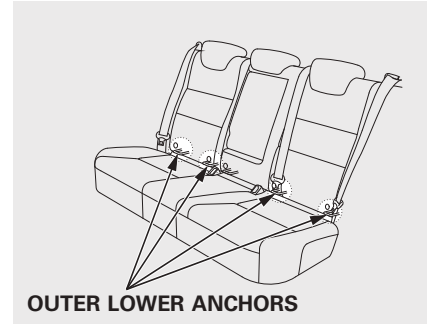

To install a LATCH-compatible child seat in either of the rear outer seats:

1. Move the seat belt buckle or tongue away from the lower anchors.
2. Make sure there are no objects near the anchors that could prevent a secure connection between the child seat and the anchors.

Installing a Child Seat

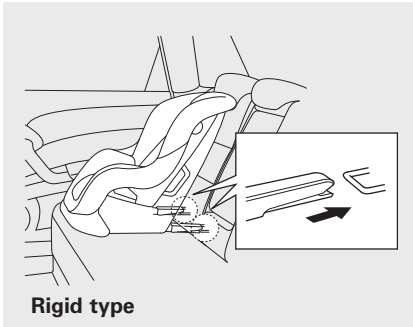

Rigid type

3. Place the child seat on the vehicle seat, then attach the seat to the lower anchors according to the child seat maker's instructions. Some LATCH-compatible seats have a rigid-type connector as shown above.

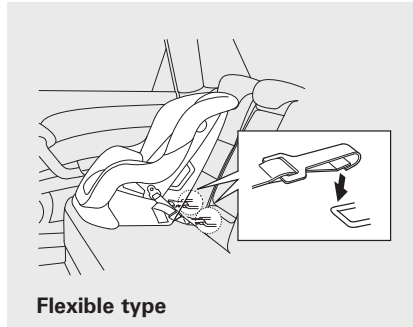

Flexible type

- Other LATCH-compatible seats have a flexible-type connector as shown above.
4. Whatever type you have, follow the child seat maker's instructions for adjusting or tightening the fit.
5. Remove the cargo area cover, and place it on the cargo area floor (see page 160).

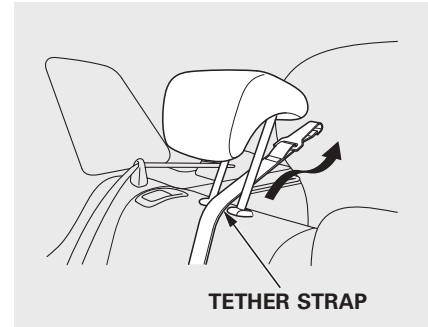

TETHER STRAP

6. Lift the head restraint (see page 135), then route the tether strap through the legs of the head restraint and over the seat-back, making sure the strap is not twisted.

CONTINUED

Installing a Child Seat

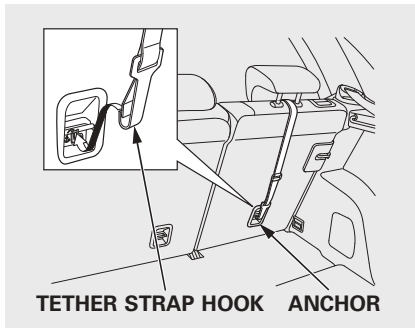

7. Attach the tether strap hook to the tether anchor, then tighten the strap as instructed by the child seat maker.
8. Push and pull the child seat forward and from side-to-side to verify that it is secure.

Using the Center LATCH

CENTER LOWER ANCHORS

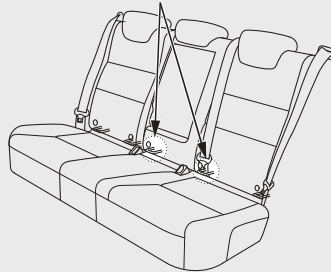

To install a LATCH-compatible child seat in the rear center seating position, use the center lower anchors as shown above.

Remove the head restraint (see page [136](#)). Make sure the removed head restraint is secured in the cargo area. Reinstall the head restraint when the child seat is removed.

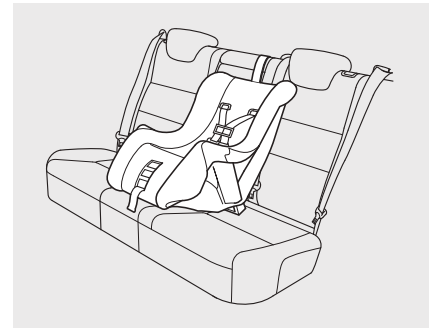

Follow step 1 through 8 as described previously to secure the child seat.

When you install the child seat in the rear center seating position, you cannot use the seat belt behind the driver's seat.

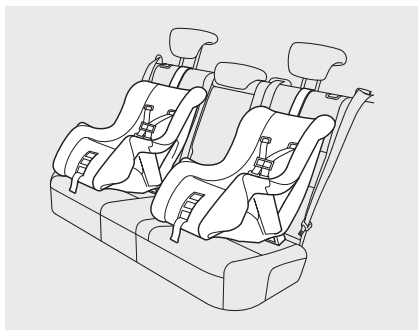

If you want to install two child seats in the back seats, place each child seat in the outer seat, as shown in the above illustration.

Do not attach two child seat connectors to a single lower anchor at a time.

The LATCH system or the child seats might be damaged if you try to install three child seats in the rear seats.

Installing a Child Seat

Installing a Child Seat with a Lap/Shoulder Belt

When not using the LATCH system, all child seats must be secured to the vehicle with the lap part of a lap/shoulder belt.

In addition, the lap/shoulder belts in all seating positions except the driver's have a lockable retractor that must be activated to secure a child seat.

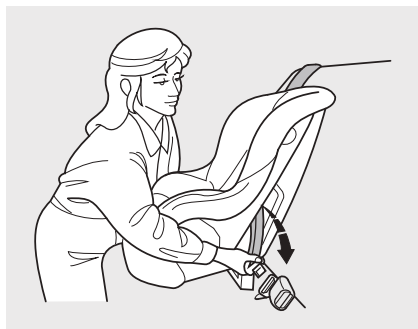

1. With the child seat in the desired seating position, route the belt through the child seat according to the seat maker's instructions, then insert the latch plate into the buckle and remove any slack from the lap portion of the belt.



2. To activate the lockable retractor, slowly pull the shoulder part of the belt all the way out until it stops, then let the belt feed back into the retractor.
3. After the belt has retracted, tug on it. If the belt is locked, you will not be able to pull it out. If you can pull the belt out, it is not locked, and you will need to repeat these steps.

Installing a Child Seat



4. After confirming that the belt is locked, grab the shoulder part of the belt near the buckle, and pull up to remove any slack from the lap part of the belt. Remember, if the lap part of the belt is not tight, the child seat will not be secure.

To remove slack, it may help to put weight on the child seat, or push on the back of the seat while pulling up on the belt.



5. Push and pull the child seat forward and from side-to-side to verify that it is secure enough to stay upright during normal driving maneuvers. If the child seat is not secure, unlatch the belt, allow it to retract fully, then repeat these steps.

To deactivate the lockable retractor and remove a child seat, unlatch the buckle, unroute the seat belt, and let the belt fully retract.

Installing a Child Seat with a Tether

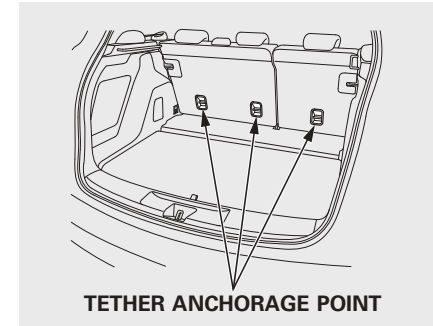

A child seat with a tether can be installed in any seating position in the back seat.

Since a tether can provide additional security to the lap/shoulder belt installation, we recommend using a tether whenever one is required or available.

CONTINUED

Installing a Child Seat

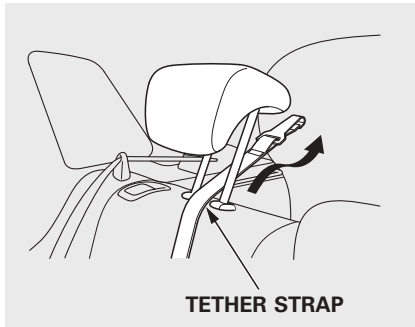

1. Remove the cargo area cover, and place it on the cargo area floor (see page 160).

2. (Outer seating position)
After properly securing the child seat (see page 50), lift the head restraint, then route the tether strap over the seat-back and through the head restraint legs.

(Rear center seating position)
Remove the head restraint (see page 136). Make sure the removed head restraint is secured in the cargo area. Reinstall the head restraint when the child seat is removed.

After properly securing the child seat (see page 50), route the tether strap over the top of the seat-back.

When you install the child seat in the rear center seating position, you cannot use the seat belt behind the driver's seat.

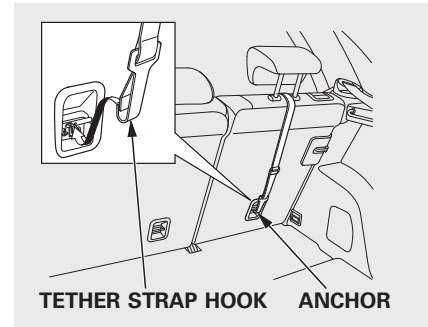

3. Attach the tether strap hook to the anchor, making sure the tether strap is not twisted.
4. Tighten the strap according to the seat maker's instructions.

If the tether strap is too long and cannot be tightened firmly, find a route where the strap can be tightened securely.

When a child reaches the recommended weight or height limit for a forward-facing child seat, the child should sit in a back seat on a booster seat and wear a lap/shoulder belt.

The following pages give instructions on how to check proper seat belt fit, what kind of booster seat to use if one is needed, and important precautions for a child who must sit in front.

⚠ WARNING

Allowing a child age 12 or under to sit in front can result in injury or death if the passenger's front airbag inflates.

If a child must ride in front, move the vehicle seat as far back as possible, use a booster seat if needed, have the child sit up properly and wear the seat belt properly.

Checking Seat Belt Fit



To determine if a lap/shoulder belt properly fits a child, have the child put on the seat belt, then ask yourself:

1. Does the child sit all the way back against the seat?
2. Do the child's knees bend comfortably over the edge of the seat?

CONTINUED

Protecting Larger Children

3. Does the shoulder belt cross between the child's neck and arm?
4. Is the lap part of the belt as low as possible, touching the child's thighs?
5. Will the child be able to stay seated like this for the whole trip?

If you answer yes to all these questions, the child is ready to wear the lap/shoulder belt correctly. If you answer no to any question, the child needs to ride on a booster seat.

Using a Booster Seat



A child who has outgrown a forward-facing child seat should ride in a back seat and use a booster seat until the lap/shoulder belt fits them properly without the booster.

Some states, Canadian provinces and territories also require children to use a booster seat until they reach a given age or weight (e.g., 6 years or 60 lbs). Be sure to check current laws in the states, provinces and territories where you intend to drive.

Booster seats can be high-back or low-back. Whichever style you select, make sure the booster seat meets federal safety standards (see page [44](#)) and that you follow the booster seat maker's instructions.

If a child who uses a booster seat must ride in front, move the vehicle seat as far back as possible and be sure the child is wearing the seat belt properly.

A child may continue using a booster seat until the tops of their ears are even with the top of the vehicle's or booster's seat-back. A child of this height should be tall enough to use the lap/shoulder belt without a booster seat.

When Can a Larger Child Sit in Front

The National Highway Traffic Safety Administration and Transport Canada recommend that all children aged 12 and under be properly restrained in a back seat.

If the passenger's front airbag inflates in a moderate to severe frontal collision, the airbag can cause serious injuries to a child who is unrestrained, improperly restrained, sitting too close to the airbag, or out of position.

A side airbag also poses risks. If any part of a larger child's body is in the path of a deploying side airbag, the child could receive possibly serious injuries.

Of course, children vary widely. And while age may be one indicator of when a child can safely ride in front, there are other important factors you should consider.

Physical Size

Physically, a child must be large enough for the lap/shoulder belt to properly fit (see pages 15 and 53). If the seat belt does not fit properly, with or without the child sitting on a booster seat, the child should not sit in front.

Maturity

To safely ride in front, a child must be able to follow the rules, including sitting properly, and wearing the seat belt properly throughout a ride.

CONTINUED

Protecting Larger Children

If you decide that a child can safely ride up front, be sure to:

- Carefully read the owner's manual, and make sure you understand all seat belt instructions and all safety information.
- Move the vehicle seat to the rear-most position.
- Have the child sit up straight, back against the seat, and feet on or near the floor.
- Check that the child's seat belt is properly and securely positioned.
- Supervise the child. Even mature children sometimes need to be reminded to fasten the seat belts or sit properly.

Additional Safety Precautions

- ***Do not let a child wear a seat belt across the neck.*** This could result in serious neck injuries during a crash.
 - ***Do not let a child put the shoulder part of a seat belt behind the back or under the arm.*** This could cause very serious injuries during a crash. It also increases the chance that the child will slide under the belt in a crash and be injured.
 - ***Two children should never use the same seat belt.*** If they do, they could be very seriously injured in a crash.
- ***Do not put any accessories on a seat belt.*** Devices intended to improve a child's comfort or reposition the shoulder part of a seat belt can make the belt less effective and increase the chance of serious injury in a crash.

Your vehicle's exhaust contains carbon monoxide gas. Carbon monoxide should not enter the vehicle in normal driving if you maintain your vehicle properly and follow the information on this page.

Have the exhaust system inspected for leaks whenever:

- The vehicle is raised for an oil change.
- You notice a change in the sound of the exhaust.
- The vehicle was in a collision that may have damaged the underside.

⚠ WARNING

Carbon monoxide gas is toxic. Breathing it can cause unconsciousness and even kill you.

Avoid any enclosed areas or activities that expose you to carbon monoxide.

High levels of carbon monoxide can collect rapidly in enclosed areas, such as a garage. Do not run the engine with the garage door closed. Even with the door open, run the engine only long enough to move the vehicle out of the garage.

With the tailgate open, airflow can pull exhaust gas into your vehicle's interior and create a hazardous condition. If you must drive with the tailgate open, open all the windows, and set the climate control system as shown below.

If you must sit in your parked vehicle with the engine running, even in an unconfined area, adjust the climate control system as follows:

1. Select the fresh air mode.
2. Select the  mode.
3. Set the fan speed to high.
4. Set the temperature control to a comfortable setting.

Safety Labels

These labels are in the locations shown. They warn you of potential hazards that could cause serious injury or death. Read these labels carefully.

If a label comes off or becomes hard to read (except for the U.S. dashboard label which may be removed by the owner), contact your dealer for a replacement.

DASHBOARD

U.S. models

This Vehicle is Equipped with Advanced Air Bags

Even with Advanced Air Bags

Children can be killed or seriously injured by the air bag.
The back seat is the safest place for children.
Never put a rear-facing child seat in the front.
Always use seat belts and child restraints.
See owner's manual for more information about air bags.

To be removed by owner only.

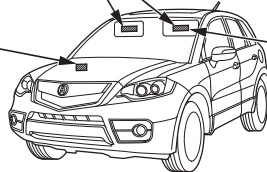

SUN VISOR

U.S. models only

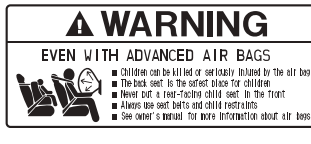

Canadian models

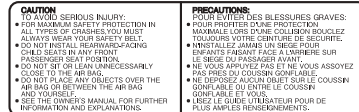

SUN VISORS

U.S. models only

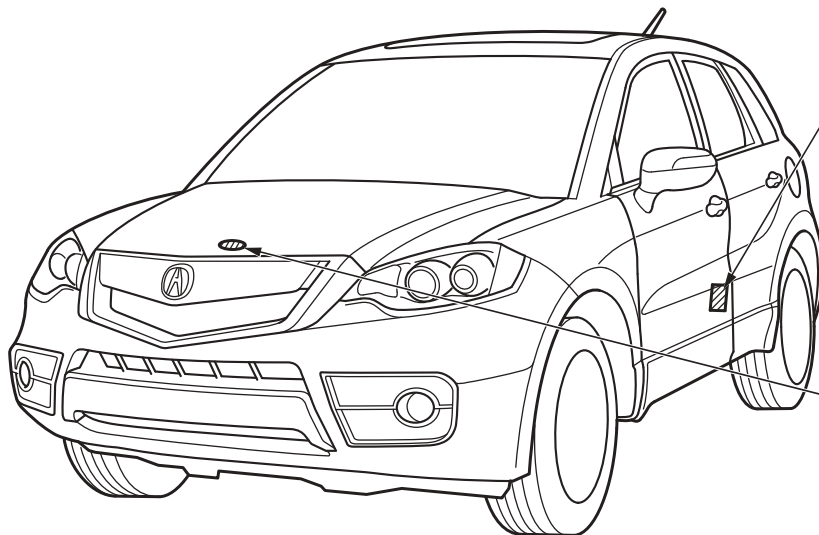

**DOOR JAMBS***U.S. models***SIDE AIRBAG**

- This car is equipped with side airbags in the front seats and side curtain airbags.
- Do not lean against the door.
- See owner's manual for more information.

*Canadian models***SIDE AIRBAG**

- This car is equipped with side airbags in the front seats and side curtain airbags.
- Do not lean against the door.
- See owner's manual for more information.

COUSSIN GONFLABLE LATÉRAL

- Cette automobile est équipée de coussins gonflables latéraux dans les sièges avant ainsi que de coussins gonflables latéraux de type rideau.
- Ne vous appuyez pas sur la porte.
- Consultez le Manuel du propriétaire pour en savoir plus.

RADIATOR CAP

[Main Menu](#)

[Table of Contents](#)

This section gives information about the controls and displays that contribute to the daily operation of your vehicle. All the essential controls are within easy reach.

| | | | | | |
|----------------------------------|-----|-----------------------------------|-----|---------------------------------|-----|
| Control Locations..... | 62 | Turn Signals and Headlights..... | 116 | Mirrors | 146 |
| Instrument Panel | 63 | Instrument Panel Brightness | 120 | Adjusting the Power | |
| Instrument Panel Indicators..... | 64 | Rear Window Defogger..... | 121 | Mirrors | 146 |
| Gauges..... | 73 | Hazard Warning Button | 121 | Reverse Tilt Door Mirror | 147 |
| Turbo Boost Meter | 73 | Steering Wheel Adjustments..... | 122 | Heated Mirrors | 147 |
| Fuel Gauge | 73 | Keys and Locks..... | 122 | Driving Position Memory | |
| Multi-Information Display | 74 | Immobilizer System | 124 | System | 148 |
| System Messages | 79 | Ignition Switch..... | 125 | Parking Brake | 150 |
| Customized Settings | 82 | Door Locks | 126 | Interior Lights..... | 151 |
| Controls Near the Steering | | Power Door Locks | 126 | Ceiling Lights | 151 |
| Wheel | 113 | Childproof Door Locks..... | 127 | Individual Map Lights | 152 |
| Windshield Wipers and | | Tailgate | 128 | Courtesy Lights | 153 |
| Washers | 114 | Remote Transmitter | 130 | Cargo Area Light..... | 153 |
| Rear Window Wiper and | | Seats | 134 | Interior Convenience Items..... | 154 |
| Washer | 115 | Front Seat Power | | Glove Box | 155 |
| | | Adjustments..... | 134 | Front Door Pockets..... | 155 |
| | | Head Restraints..... | 135 | Beverage Holders | 156 |
| | | Armrests | 138 | Accessory Power Sockets | 157 |
| | | Folding the Rear Seats | | Sun Visor | 157 |
| | | Down | 138 | Vanity Mirror | 158 |
| | | Seat Heaters..... | 141 | Console Compartment | 158 |
| | | Power Windows | 142 | Cargo Area Cover | 160 |
| | | Moonroof..... | 144 | | |

Control Locations

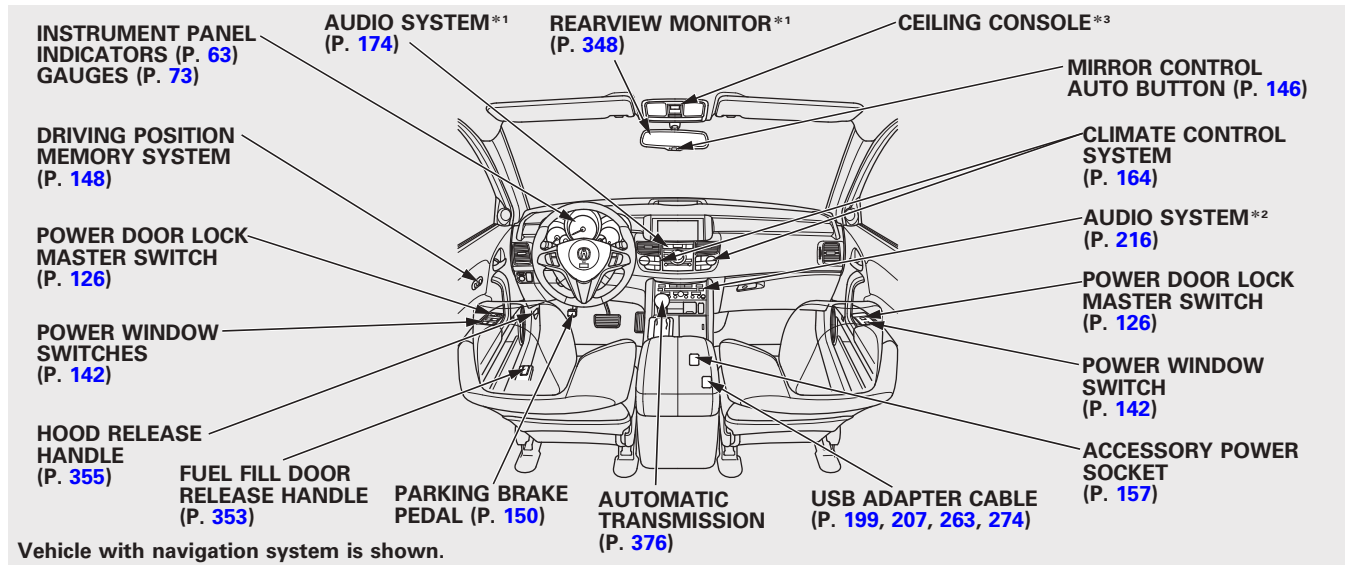

*1: On models without navigation system.

*2: On models with navigation system.

*3: HomeLink® Buttons (P. 303)

Moonroof Switch (P. 144)

Front Ceiling Light Switch (P. 151)

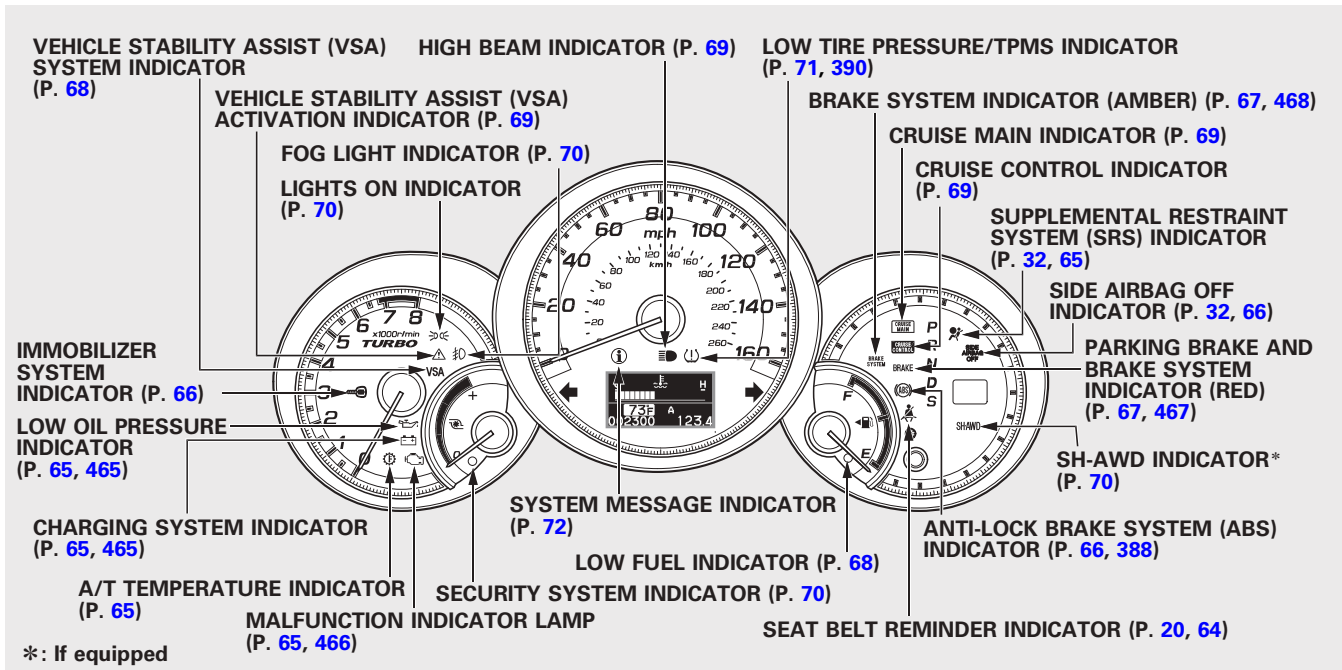

The U.S. instrument panel is shown. Differences for the Canadian models are noted in the text.

Instrument Panel Indicators

The instrument panel has many indicators that give you important information about your vehicle.



Seat Belt Reminder Indicator

This indicator reminds you and your passengers to fasten your seat belts.

If you turn the ignition switch to the ON (II) position before fastening your seat belts, the beeper sounds, and the indicator flashes. If you do not fasten your seat belts before the beeper stops, the indicator stops flashing but remains on.

If your front passenger does not fasten their seat belt, the indicator comes on about 6 seconds after the ignition switch is turned to the ON (II) position.

If either of you do not fasten your seat belt while driving, the beeper will sound and the indicator will flash again at regular intervals. For more information, see page [20](#).

You will also see a “FASTEN SEAT BELT” or “FASTEN PASSENGER SEAT BELT” message on the multi-information display.



Malfunction Indicator Lamp

You will also see a “CHECK EMISSION SYSTEM” message on the multi-information display. For more information, see page 466.



Low Oil Pressure Indicator

The engine can be severely damaged if this indicator flashes or stays on when the engine is running. For more information, see page 465. You will also see a “OIL PRESSURE LOW” message on the multi-information display (see page 79).



Charging System Indicator

If this indicator comes on when the engine is running, the battery is not being charged, and you will also see a “CHECK CHARGING SYSTEM” message on the multi-information display. For more information, see page 465.



A/T Temperature Indicator

This indicator monitors the temperature of the automatic transmission fluid. If it comes on while driving, it means the transmission fluid temperature is too high. Pull to the side of the road when it is safe, shift to Park, and let the engine idle until the indicator goes out.

You will also see a “CHECK TRANSMISSION” message on the multi-information display (see page 80).

NOTICE

Continuing to drive with the A/T temperature indicator on may cause serious damage to the transmission.



Supplemental Restraint System (SRS) Indicator

This indicator comes on for several seconds when you turn the ignition switch to the ON (II) position. If it comes on at any other time, it indicates a potential problem with your front airbags. This indicator will also alert you to a potential problem with your side airbags, passenger's side airbag automatic cutoff system, automatic seat belt tensioners, side curtain airbags, driver's seat position sensor, and the front passenger's weight sensors. You will also see a “CHECK AIRBAG SYSTEM” message on the multi-information display (see page 80). For more information, see page 32.

CONTINUED

Instrument Panel Indicators

U.S.



Canada



Side Airbag Off Indicator

This indicator comes on when you turn the ignition switch to the ON (II) position. If it comes on at any other time, it indicates that the passenger's side airbag has automatically shut off. You will also see a "PASSENGER SIDE AIRBAG OFF" message on the multi-information display (see page 80). For more information, see page 32.



Anti-lock Brake System (ABS) Indicator

This indicator normally comes on for a few seconds when you turn the ignition switch to the ON (II) position, and when the ignition switch is turned to the START (III) position. If this indicator comes on at any other time, there is a problem in the ABS. If this happens, take the vehicle to your dealer to have it checked. With this indicator on, your vehicle still has normal braking ability but no anti-lock function. You will also see a "CHECK ABS SYSTEM" message on the multi-information display (see page 80). For more information, see page 388.



Immobilizer System Indicator

This indicator comes on briefly when you turn the ignition switch to the ON (II) position. It will then go off if you have inserted a properly coded ignition key. If it is not a properly coded key, the indicator will blink, and the engine's fuel system will be disabled (see page 124).

U.S. Canada

BRAKE



Parking Brake and Brake System Indicator (Red)

This indicator has two functions:

1. It comes on when you turn the ignition switch to the ON (II) position. It is a reminder to check the parking brake. Driving with the parking brake not fully released can damage the brakes and tires.

If you drive without releasing the parking brake, a beeper will sound, and you will also see a “RELEASE PARKING BRAKE” message on the multi-information display (see page 79).

2. If it stays on after you have fully released the parking brake while the engine is running, or if it comes on while driving, it can indicate a problem in the brake system. You will also see a “BRAKE FLUID LOW” or “CHECK BRAKE SYSTEM” message on the multi-information display. For more information, see page 467.

U.S. Canada

BRAKE SYSTEM



Brake System Indicator (Amber)

The brake system indicator (amber) normally comes on when you turn the ignition switch to the ON (II) position and goes off after the engine starts. If it comes on at any other time, there is a problem in the brake system including the electric vacuum pump. If this happens, have your vehicle checked by your dealer. For more information, see page 468.

You will also see a “CHECK BRAKE SYSTEM” message on the multi-information display (see page 79).

CONTINUED

Instrument Panel Indicators

Low Fuel Indicator

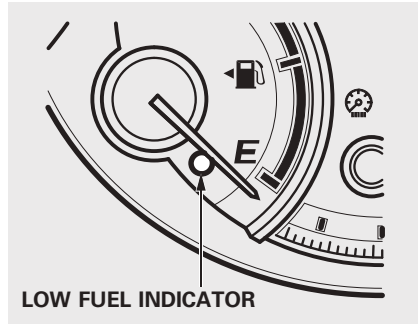

This indicator comes on as a reminder that you must refuel soon. When the indicator comes on, there are about 2.5 U.S. gal (9.5 L) of fuel remaining in the tank.

When the needle reaches E, there is a very small amount of fuel in the tank.

You will also see a “FUEL LOW” message on the multi-information display (see page [80](#)).

NOTICE

Avoid driving with an extremely low fuel level. Running out of fuel could cause the engine to misfire, damaging the catalytic converter.

VSA Vehicle Stability Assist (VSA) System Indicator

This indicator normally comes on for a few seconds when you turn the ignition switch to the ON (II) position.

If it comes on and stays on at any other time, or it does not come on when you turn the ignition switch to the ON (II) position, there is a problem with the VSA system. You will also see a “CHECK VSA SYSTEM” message on the multi-information display (see page [80](#)). Take your vehicle to a dealer to have it checked. Without VSA, your vehicle still has normal driving ability, but will not have VSA traction and stability enhancement. For more information, see page [395](#).



VSA Activation Indicator

This indicator has three functions:

1. It comes on as a reminder that you have turned off the vehicle stability assist (VSA) system.
2. It flashes when VSA is active (see page 395).
3. It comes on along with the VSA system indicator if there is a problem with the VSA system. You will also see a “CHECK VSA SYSTEM” message on the multi-information display (see page 80).

This indicator normally comes on for a few seconds when you turn the ignition switch to the ON (II) position. For more information, see page 395.



Cruise Main Indicator

This indicator comes on when you turn on the cruise control system by pressing the CRUISE button (see page 300).



Cruise Control Indicator

This indicator comes on when you set the cruise control. See page 300 for information on operating the cruise control.



High Beam Indicator

This indicator comes on with the high beam headlights. For more information, see page 117.

This indicator also comes on with reduced brightness when the daytime running lights (DRL) are on (see page 119).



Turn Signal and Hazard Warning Indicators

The left or right turn signal indicator blinks when you signal a lane change or turn. If an indicator does not blink or blinks rapidly, it usually means one of the turn signal bulbs is burned out (see pages 432 and 434). Replace the bulb as soon as possible, since other drivers cannot see that you are signaling.

When you press the hazard warning button, both turn signal indicators and all turn signals on the outside of the vehicle flash.

CONTINUED

Instrument Panel Indicators

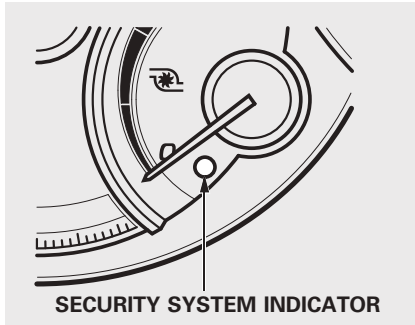

Security System Indicator



This indicator comes on when the security system is set. For more information, see page [294](#).



Lights On Indicator

This indicator reminds you that the exterior lights are on. It comes on when the light switch is in either the  or  position. If you turn the ignition switch to the ACCESSORY (I) or the LOCK (0) position without turning off the light switch, this indicator will remain on. A reminder chime will also sound when you open the driver's door and remove the key from the ignition switch.



Fog Light Indicator

This indicator comes on when you turn on the fog lights. For more information, see page [119](#).



Super Handling-All Wheel Drive (SH-AWD) Indicator

On SH-AWD models

This indicator normally comes on for a few seconds when you turn the ignition switch to the ON (II) position. If this indicator comes on at any other time, there is a problem in the SH-AWD system. You will also see a "CHECK SH-AWD SYSTEM" message on the multi-information display (see page [80](#)). Take your vehicle to a dealer to have it checked. For more information, see page [385](#).

If this indicator blinks while driving, it indicates the differential temperature is too high.

You will also see an “SH-AWD DIFF TEMP. HIGH” message on the multi-information display (see page 80).

Pull to the side of the road when it is safe, shift to Park, and let the engine idle until the indicator goes out. If the indicator does not go out, take your vehicle to a dealer to have it checked.

For more information, see page 385.

NOTICE

Continuing to drive with the SH-AWD indicator blinking may cause serious damage to the system.



Low Tire Pressure/TPMS Indicator

This indicator normally comes on for a few seconds when you turn the ignition switch to the ON (II) position.

This indicator has two functions:

1. If it comes on while driving, it indicates that one or more of your vehicle's tires are significantly low on pressure.

You will also see a “CHECK TIRE PRESSURE” message on the multi-information display (see page 79).

Check the tire pressure monitor on the multi-information display and determine the cause (see page 392).

If this happens, pull to the side of the road when it is safe, check which tire has lost pressure on the multi-information display, and determine the cause. If it is because of a flat tire, have the flat tire repaired as soon as possible. If two or more tires are underinflated, call a professional towing service. For more information, see page 475.

CONTINUED

Instrument Panel Indicators

2. If this indicator begins to flash, there is a problem with the tire pressure monitoring system (TPMS). You will also see a “CHECK TPMS SYSTEM” message on the multi-information display. The indicator continues to flash for a while (approximately 1 minute), then stays on. If this happens, have your dealer check the system as soon as possible. For more information, see page [393](#).



System Message Indicator

This indicator comes on when there is a system message on the multi-information display. Press the INFO button on the steering wheel (see page [74](#)) to see the message (see page [81](#)).

Most of the time, this indicator comes on along with other indicators in the instrument panel such as the seat belt reminder indicator, SRS indicator, VSA system indicator, etc.

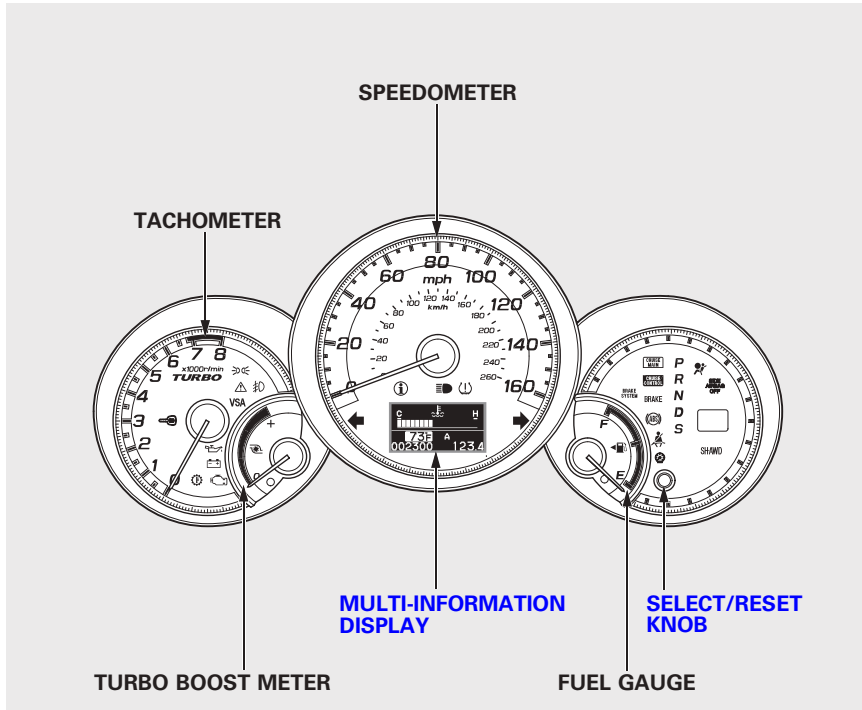

Turbo Boost Meter

When the turbo charger is activated, this meter shows the boost pressure.

Fuel Gauge

This shows how much fuel you have. It may show slightly more or less than the actual amount. The needle returns to the bottom after you turn off the ignition.

NOTICE

Avoid driving with an extremely low fuel level. Running out of fuel could cause the engine to misfire, damaging the catalytic converter.

Multi-Information Display

The multi-information display in the instrument panel displays various information and messages when the ignition switch is in the ON (II) position. Some of the messages help you operate your vehicle more comfortably.

Others help to keep you aware of the periodic maintenance your vehicle needs for continued trouble-free driving.

When you open the driver's door, a "Welcome" message is shown on the multi-information display. When you turn the ignition switch from the ON (II) position to the ACCESSORY (I) position, a "Goodbye" message is shown on the display.

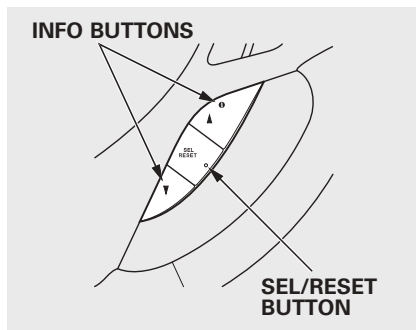

To change the display, press the SEL/RESET button or INFO (▲/▼) button on the steering wheel repeatedly until the desired information appears (see page 75).

You can also change the display by pressing the select/reset knob in the instrument panel.

When you turn the ignition switch to the ON (II) position, your last selection is displayed.

In the multi-information display, the system message is also displayed (see page 79) and you can customize your vehicle control settings (see page 82).

Multi-Information Display

U.S. model is shown.

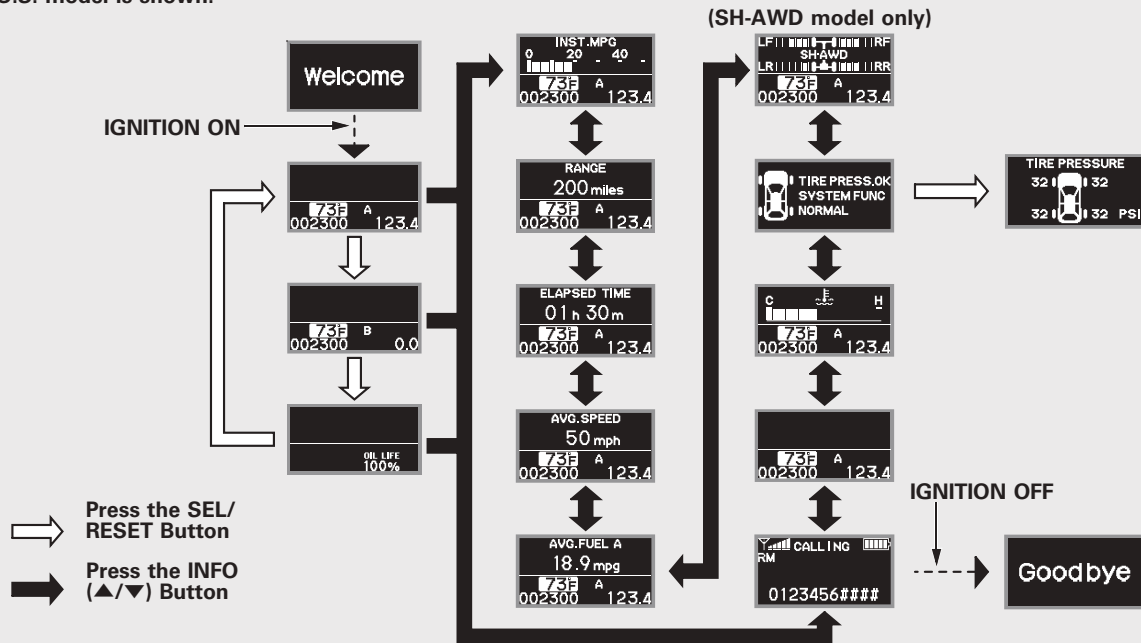

CONTINUED

Multi-Information Display

Odometer

The odometer shows the total distance your vehicle has been driven. It measures miles in U.S. models and kilometers in Canadian models. It is illegal under U.S. federal law and Canadian provincial/territorial regulations to disconnect, reset, or alter the odometer with the intent to change the number of miles or kilometers indicated.

Trip Meter

This meter shows the number of miles (U.S.) or kilometers (Canada) driven since you last reset it. There are two trip meters: Trip A and Trip B. Each trip meter works independently, so you can keep track of two different distances.

To reset a trip meter, display it, then press and hold the SEL/RESET button until the number resets to "0.0".

When you reset Trip A, AVG. FUEL A is reset at the same time. When you reset Trip B, AVG. FUEL B is reset.

You can customize the Trip A and AVG. FUEL A reset condition on the multi-information display (see page [93](#)).

Outside Temperature Display

This shows the outside temperature in Fahrenheit (U.S. models), or in Celsius (Canadian models).

The temperature sensor is in the front bumper. The temperature reading can be affected by heat reflection from the road surface, engine heat, and the exhaust from surrounding traffic. This can cause an incorrect temperature reading when your vehicle speed is under 19 mph (30 km/h). When you start your trip, the sensor is not fully acclimatized, therefore it may take several minutes until the proper temperature is displayed.

In certain weather conditions, temperature readings near freezing (32°F, 0°C) could mean that ice is forming on the road surface.

You can adjust the outside temperature display (see page [91](#)).

Maintenance Minder

The multi-information display in the instrument panel shows you the engine oil life and maintenance service items when the ignition switch is in the ON (II) position. This information helps to keep you aware of the periodic maintenance your vehicle needs for continued trouble-free driving. Refer to page 411 for more information.

INST. MPG (U.S. models)/INST. L/100 km (Canadian models)

This shows your instant fuel economy.

When you turn off the engine, INST. MPG or INST. L/100 km is also reset.

RANGE

This shows the estimated distance you can travel on the fuel remaining in the fuel tank. This distance is estimated from the fuel economy you received over the last several miles (U.S.) or kilometers (Canada), so it will vary with changes in speed, traffic, etc.

When the battery is disconnected, or you refuel, RANGE is also reset.

ELAPSED TIME

This shows the accumulated traveling time since you last reset it. When you turn the ignition switch to the ON (II) position, ELAPSED TIME is reset.

You can customize the ELAPSED TIME reset condition on the multi-information display (see page 95).

AVG. SPEED

This shows the average speed you are traveling in miles per hour (mph) for U.S. models or kilometers per hour (km/h) for Canadian models.

When you reset Trip A, AVG. SPEED is also reset.

AVG. FUELA/B

This shows your vehicle's average fuel economy in mpg (U.S. models) or liter/100 km (Canadian models) since you last reset Trip A or Trip B.

You can customize the Trip A and AVG. FUEL A reset condition on the multi-information display (see page 93).

The average fuel economy will be reset when you reset the trip meter, or if the vehicle's battery goes dead or is disconnected.

CONTINUED

Multi-Information Display

SH-AWD Torque Distribution Monitor

On SH-AWD models

This monitor shows how much torque is being delivered to each wheel. For more information, see page [384](#).

Tire Pressure Monitor

You can see the pressure of each tire in this monitor. If one or more tire pressure are low, inflate them to the correct pressure. For more information, see page [392](#).

Temperature Gauge

This shows the temperature of the engine's coolant. During normal operation, the reading should rise from the "C (Cold)" mark to about the middle of the gauge. In severe driving conditions, such as very hot weather or a long period of uphill driving, the reading may rise to near the "H (Hot)" mark of the gauge. If it reaches the "H" mark, pull safely to the side of the road. See page [463](#) for instructions and precautions on checking the engine's coolant system.

Bluetooth® HandsFreeLink®















You can receive or make phone calls from your cell phone through your vehicle's **Bluetooth® HandsFreeLink®** (HFL) system without touching your cell phone.

To use the system, your cell phone and the HFL system must be linked. Not all cell phones are compatible with this system. Refer to page [313](#) for instructions on how to link your cell phone to HFL and how to receive or make phone calls, or visit the acura.com/handsfreelink website. In Canada, visit www.acura.ca, or call 1-(888) 9-HONDA-9.

System Messages

















If there is a problem with your vehicle, for example, the engine oil level is low or a door is not fully closed, the multi-information display will show you the problem. It does this by interrupting the current display with one or more messages.

Here is a list of messages shown on the multi-information display:

| | | | | |
|---|---|----------------------|---|-----------------|
|  FASTEN SEATBELT |  FASTEN PASSENGER SEATBELT | See page 20 |  CHECK TPMS SYSTEM | See page 393 |
|  DOOR OPEN | | See page 12 |  CHECK TIRE PRESSURE | See page 392 |
|  RELEASE PARKING BRAKE |  RELEASE PARKING BRAKE | See page 67 |  OIL PRESSURE LOW | See page 465 |
| U.S. | Canada | |  CHECK CHARGING SYSTEM | See page 465 |
|  BRAKE FLUID LOW |  BRAKE FLUID LOW | See page 467 |  CHECK EMISSION SYSTEM | See page 466 |
| U.S. | Canada | | | |
|  CHECK BRAKE SYSTEM |  CHECK BRAKE SYSTEM | See page 467, 468 | | |
| U.S. | Canada | | | |

CONTINUED

Multi-Information Display

| | | | | | |
|--|---------------------------------|--|---------------------------------|---|---------------------------------|
|  | See page 376 |  | See page 395 |  | See page 12 |
|  SH-AWD model only | See page 385 |   U.S. Canada | See page 375 |  | See page 354 |
|  SH-AWD model only | See page 385 |   U.S. Canada | See page 32 |  | See page 426 |
|  | See page 32 |  | See page 119 |  | See page 412 |
|  | See page 388 |  | See page 68 |  | See page 125 |

The system message(s) triggers the appropriate indicator(s) on the instrument panel, including the system message indicator, to come on. The system message indicator does not go off until the problem(s) is corrected.

You will also hear a beep when the system message comes on for the first time.

Most of the messages are displayed for about 5 seconds, and then the normal display returns. If there are several system messages to be shown, the display switches these messages every 5 seconds.

To switch the message(s) before 5 seconds have elapsed, press the INFO (▲/▼) button on the steering wheel.

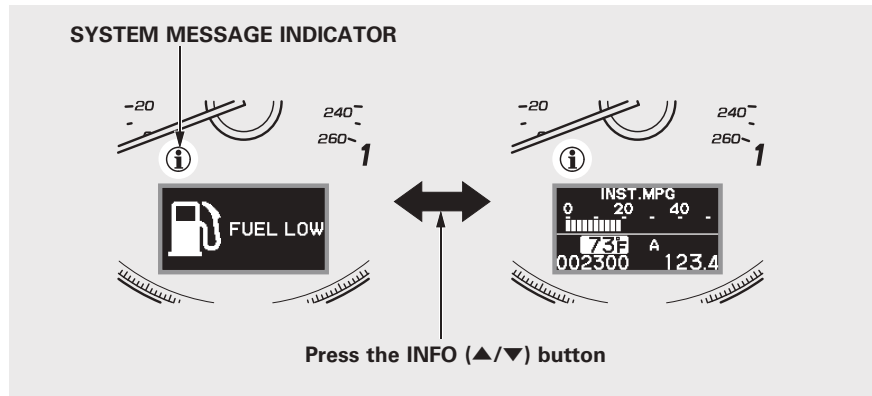

Even if you press the INFO (▲/▼) button, some messages stay on or come on again at regular intervals until the problem is corrected.

- FASTEN SEAT BELT
- FASTEN PASSENGER SEAT BELT
- RELEASE PARKING BRAKE
- DOOR & TAILGATE OPEN

If the system message indicator remains lit on the instrument panel, you can see the corresponding message(s) again by pressing the INFO (▲/▼) button repeatedly.

Multi-Information Display

Customized Settings

With the multi-information display and the INFO (▲/▼) and SEL/RESET buttons on the right side of the steering wheel, you can customize some vehicle control settings.

To enter the customizing mode, press and hold the INFO (▲/▼) button for more than 3 seconds.

To change the settings, the ignition switch must be in the ON (II) position, and the vehicle must be stopped with the transmission in Park.

You cannot customize the settings under these conditions:

- If you turn the ignition switch to the ACCESSORY (I) or the LOCK (0) position.
- If you move the shift lever out of Park.

The first customizing menu is:

- DEFAULT ALL
- CHG SETTING

If you want the settings as they were when the vehicle left the factory, select DEFAULT ALL, as described on page [85](#).

If you want to change any vehicle control settings, select CHG SETTING, then press the SEL/RESET button (see page [86](#)).

Refer to the table on the following pages about the settings you want to customize.

Multi-Information Display

| Customize Entry | Customize Group | Customize Menu | Description | Customize Setup | Page |
|------------------------|-------------------------------|--|---|--|------|
| CHG SETTING (P. 86) | METER SETUP (P. 88) | LANGUAGE SELECTION | Changes the language used in the display. | ENGLISH* | 89 |
| | | | | FRENCH | |
| | | | | SPANISH | |
| | | ADJUST OUTSIDE TEMP. DISPLAY | Changes the outside temperature reading above or below its current reading. | -5°F ~ ±0°F* ~ 5°F -3°C ~ ±0°C* ~ 3°C | 91 |
| | | TRIP A & AVG. FUEL RESET with REFUEL | Causes trip meter A and the average fuel economy to reset when you refuel. | ON OFF* | 93 |
| | ELAP. TIME RESET CONDITION | Resets the elapsed time of your current trip. | IGN RESET* | 95 | |
| | | | TRIP A RESET | | |
| | | | TRIP B RESET | | |
| | LIGHTING SETUP (P. 97) | INTERIOR LIGHT DIMMING TIME | Changes how long (in seconds) the interior lights stay on after you close the doors. | 15 sec | 98 |
| | | | | 30 sec* | |
| | | | | 60 sec | |
| | HEADLIGHT AUTO OFF TIMER | Changes how long (in seconds) the exterior lights stay on after you close the driver's door. | 0 sec | 100 | |
| | | | 15 sec* | | |
| 30 sec | | | | | |
| 60 sec | | | | | |
| DOOR SETUP (P. 102) | AUTO DOOR LOCK | Changes when the system automatically locks the doors. | SHIFT FROM P | 103 | |
| | | | WITH VEH SPEED* | | |
| | | | OFF | | |

*: Default setting

CONTINUED

Multi-Information Display

| Customize Entry | Customize Group | Customize Menu | Description | Customize Setup | Page | | |
|------------------------|------------------------|---------------------------------|--|------------------|---|---------------------------------|-----|
| CHG SETTING (P. 86) | DOOR SETUP (P. 102) | DOOR LOCK MODE | Changes which doors unlock with the remote transmitter on a first push. | DRIVER DOOR* | 105 | | |
| | | | | ALL DOORS | | | |
| | | KEYLESS LOCK ACKNOWLEDGEMENT | The exterior lights flash each time you press the LOCK or UNLOCK button. A beeper will also sound when you press the LOCK button twice. | ON* | 107 | | |
| | | | | OFF | | | |
| | | SECURITY RELOCK TIMER | Changes how long it takes (in seconds) for the doors to relock and the security system to set after you unlock but do not open the door. | 30 sec* | 109 | | |
| | | | | 60 sec | | | |
| | | | | 90 sec | | | |
| | | | | AUTO DOOR UNLOCK | Changes when the system automatically unlock the driver's/all of the doors. | DRIVER DOOR WITH SHIFT TO P* | 111 |
| | | | | | ALL DOORS WITH SHIFT TO P | | |
| | | | | | DRIVER'S DOOR WITH IGN OFF | | |
| | | | ALL DOORS WITH IGN OFF | | | | |
| | | | OFF | | | | |
| DEFAULT ALL | | | Returns all settings to the factory default. | SET | 85 | | |
| | | | | EXIT | | | |

*: Default setting

DEFAULT ALL

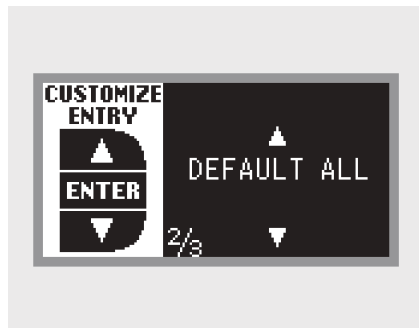

To enter the customizing mode, press and hold the INFO (▲/▼) button for more than 3 seconds.

If you want to set the default settings, press the INFO (▲/▼) button to select DEFAULT ALL, then press the SEL/RESET button.

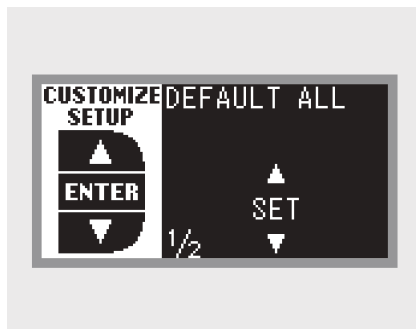

To set the default settings, press the INFO (▲/▼) button to select SET then press the SEL/RESET button.



When DEFAULT ALL is set, you will see the above display for several seconds, then the screen returns to CUSTOMIZE ENTRY.

CONTINUED

Multi-Information Display



If DEFAULT ALL is not set, you will see the above display for several seconds, then the screen goes back to CUSTOMIZE ENTRY. Repeat the procedure to select DEFAULT ALL.

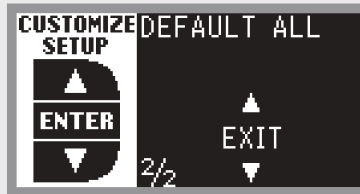

If you want to cancel DEFAULT ALL, select EXIT, then press the SEL/RESET button. The screen goes back to CUSTOMIZE ENTRY.

Change Settings

You can customize some of the vehicle control settings to your preference. Here are the settings you can customize:

- METER SETUP
- LIGHTING SETUP
- DOOR SETUP

While CHG SETTING in the CUSTOMIZE ENTRY is shown on the multi-information display, press the SEL/RESET button. The screen changes to METER SETUP in the CUSTOMIZE GROUP.

Each time you press the INFO (▲/▼) button, the screen changes as shown on the next page. Press the INFO (▲/▼) button, until you see the setup you want to customize, then press the SEL/RESET button to enter your selection.

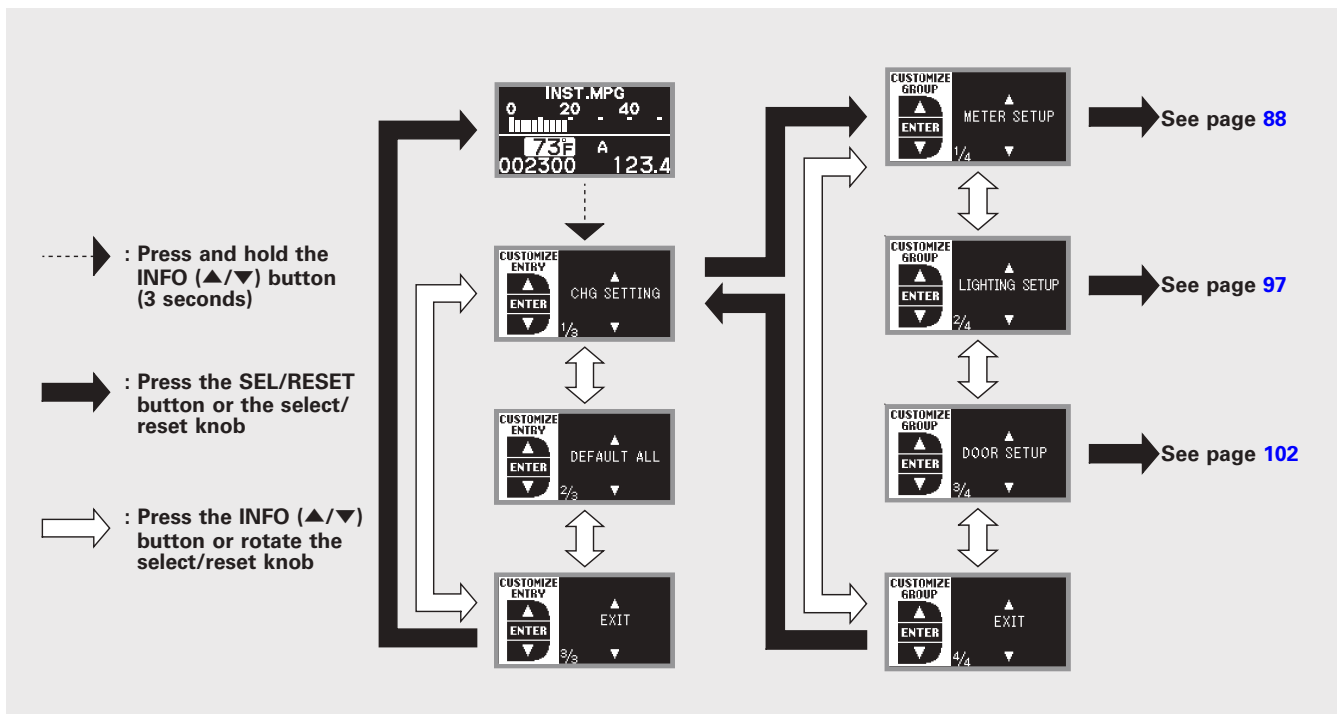

CONTINUED

Multi-Information Display

Meter Setup

Here are the four custom settings for the meter setup:

- LANGUAGE SELECTION
- ADJUST OUTSIDE TEMP. DISPLAY
- TRIP A & AVG. FUEL RESET with REFUEL
- ELAP. TIME RESET CONDITION

While METER SETUP is shown in the CUSTOMIZE GROUP of the multi-information display, press the SEL/RESET button.

Each time you press the INFO (▲/▼) button, the screen changes as shown in the illustration. Press the INFO (▲/▼) button until you see the setting you want to customize, then press the SEL/RESET button to enter your selection.

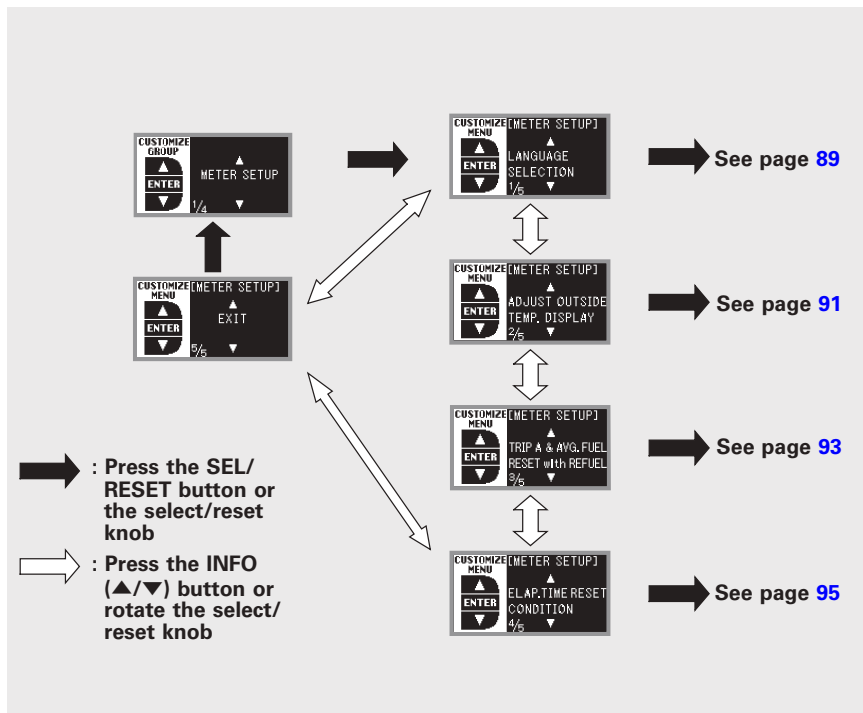

Multi-Information Display

Language Selection

There are three language selections you can make: English, French, and Spanish. To choose the language you want, follow these instructions:



While METER SETUP is shown in the CUSTOMIZE GROUP of the multi-information display, press the SEL/RESET button. You will see the above display.



Select the desired language by pressing the INFO (▲/▼) button, then enter your selection by pressing the SEL/RESET button.

CONTINUED

Multi-Information Display

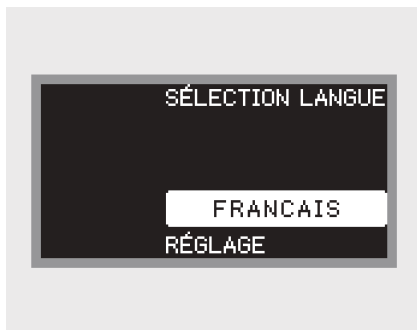

When your choice is set, you will see the above display for several seconds, then the screen goes back to CUSTOMIZE MENU.

All messages on the multi-information display will be shown in the language you selected.

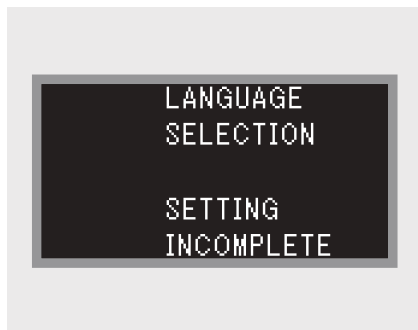

If your choice is not set, you will see the above display for several seconds, then the screen goes back to CUSTOMIZE MENU. If this happens, you need to repeat the same procedure.

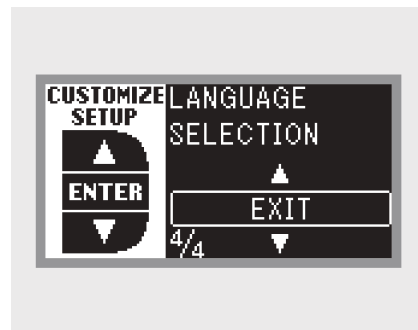

To exit LANGUAGE SELECTION without changing the current setting, select EXIT by pressing the INFO (▲/▼) button, then press the SEL/RESET button. The screen goes back to CUSTOMIZE MENU.

Multi-Information Display

Adjust Outside Temp. Display

If you sometimes find that the temperature reading is a few degrees above or below the actual temperature, you can adjust it by following these instructions:

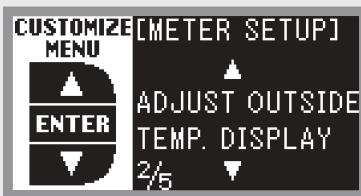

While METER SETUP is shown in the CUSTOMIZE GROUP of the multi-information display, press the SEL/RESET button. The screen changes to CUSTOMIZE MENU. Press the INFO (▲/▼) button until you see the above display.



U.S.



Canada

Press the SEL/RESET button. The screen changes as shown above. The highlighted number is the current setting above or below the outside temperature. Press the INFO (▲/▼) button repeatedly until the number you want appears, then press the SEL/RESET button to enter your selection.

CONTINUED

Multi-Information Display



U.S.



Canada

When your choice is set, you will see the above display for several seconds, then the screen goes back to CUSTOMIZE MENU.

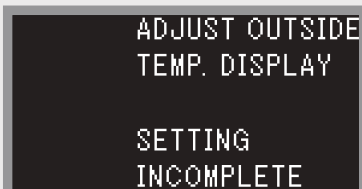

If your choice is not set, you will see the above display for several seconds, then the screen goes back to CUSTOMIZE MENU. If this happens, you need to repeat the same procedure.



To exit ADJUST OUTSIDE TEMP. DISPLAY without changing the current setting, select EXIT by pressing the INFO (▲/▼) button, then press the SEL/RESET button. The screen goes back to CUSTOMIZE MENU.

Multi-Information Display

Trip A & Avg. Fuel Reset with Refuel
To cause Trip A and AVG. FUEL A to reset every time you refuel your vehicle, follow these instructions:



While METER SETUP is shown in the CUSTOMIZE GROUP of the multi-information display, press the SEL/RESET button. The screen changes to CUSTOMIZE MENU. Press the INFO (▲/▼) button until you see the above display.



Press the SEL/RESET button. The screen changes as shown above. Select ON or OFF by pressing the INFO (▲/▼) button, then press the SEL/RESET button to enter your selection.

CONTINUED

Multi-Information Display

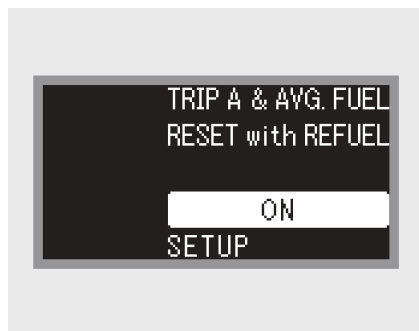

When your choice is set, you will see the above display for several seconds, then the screen goes back to CUSTOMIZE MENU.

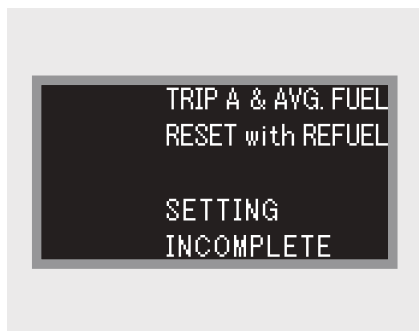

If your choice is not set, you will see the above display for several seconds, then the screen goes back to CUSTOMIZE MENU. If this happens, you need to repeat the same procedure.

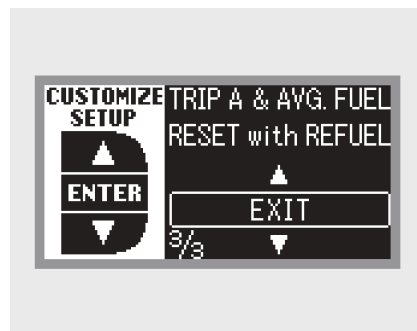

To exit TRIP A & AVG. FUEL RESET with REFUEL without changing the current setting, select EXIT by pressing the INFO (▲/▼) button, then press the SEL/RESET button. The screen goes back to CUSTOMIZE MENU.

Multi-Information Display

Elap. Time Reset Condition

There are three elapsed time reset choices you can make:

IGN RESET – The elapsed time is reset when you turn the ignition switch to the LOCK (0) position.

TRIP A – The elapsed time is reset when Trip A is reset.

TRIP B – The elapsed time is reset when Trip B is reset.

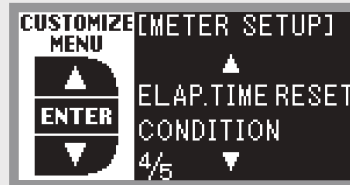

While METER SETUP is shown in the CUSTOMIZE GROUP of the multi-information display, press the SEL/RESET button. The screen changes to CUSTOMIZE MENU. Press the INFO (▲/▼) button until you see the above display.

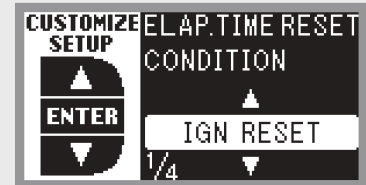

Press the SEL/RESET button. The screen changes as shown above. Select the desired setting by pressing the INFO (▲/▼) button, then press the SEL/RESET button to enter your selection.

CONTINUED

Multi-Information Display



When your choice is set, you will see the above display for several seconds, then the screen goes back to CUSTOMIZE MENU.

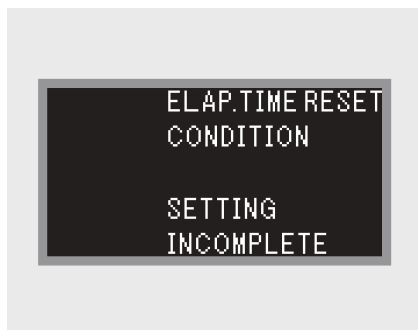

If your choice is not set, you will see the above display for several seconds, then the screen goes back to CUSTOMIZE MENU. If this happens, you need to repeat the same procedure.

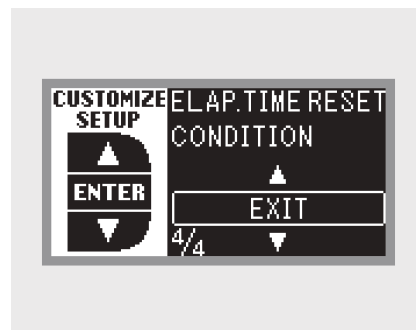

To exit ELAP. TIME RESET CONDITION without changing the current setting, select EXIT by pressing the INFO (▲/▼) button, then press the SEL/RESET button. The display goes back to CUSTOMIZE MENU.

Lighting Setup

There are two settings in the lighting setup:

- INTERIOR LIGHT DIMMING TIME
- HEADLIGHT AUTO OFF TIMER

While CUSTOMIZE GROUP is shown on the multi-information display, select LIGHTING SETUP by pressing the INFO (▲/▼) button, then press the SEL/RESET button.

Each time you press the INFO (▲/▼) button, the screen changes as shown in the illustration. Press the INFO (▲/▼) button until you see the setting you want to customize, then press the SEL/RESET button to enter your selection.

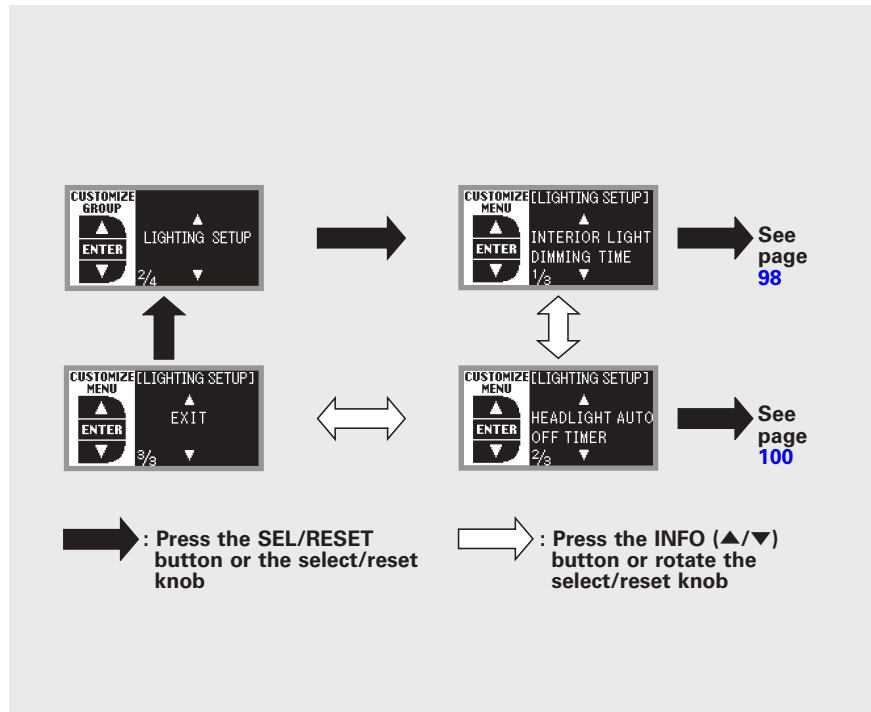

CONTINUED

Multi-Information Display

Interior Light Dimming Time

The interior lights fade out when you close all doors. You can change the time that the interior lights fade out.



While LIGHTING SETUP is shown in the CUSTOMIZE GROUP of the multi-information display, press the SEL/RESET button. You will see the above display.

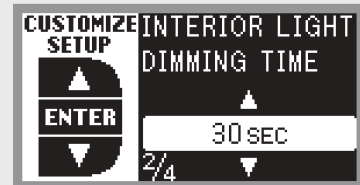

Press the SEL/RESET button. The screen changes as shown above. Select how long you want the lights to stay on before they fade out (15, 30, or 60 seconds) by pressing the INFO (▲/▼) button, then press the SEL/RESET button to enter your selection.

Multi-Information Display

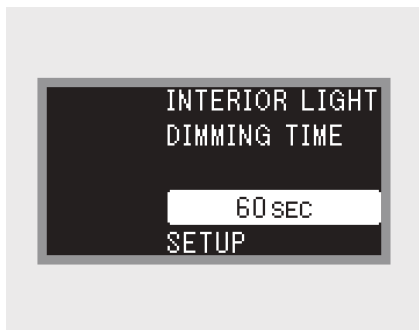

When your choice is set, you will see the above display for several seconds, then the screen goes back to CUSTOMIZE MENU.

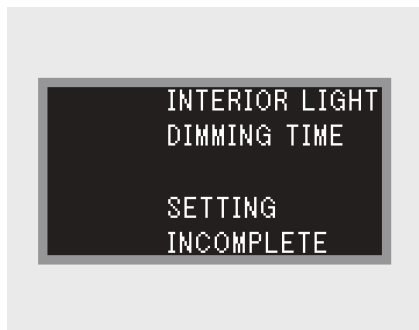

If your choice is not set, you will see the above display for several seconds, then the screen goes back to CUSTOMIZE MENU. If this happens, you need to repeat the same procedure.

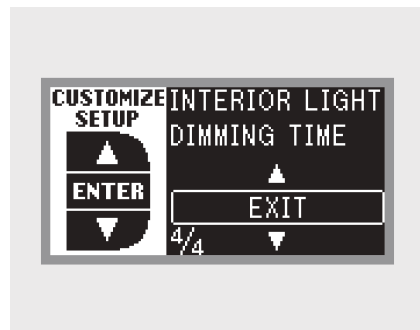

To exit INTERIOR LIGHT DIMMING TIME without changing the current setting, select EXIT by pressing the INFO (▲/▼) button, then press the SEL/RESET button. The screen goes back to CUSTOMIZE MENU.

CONTINUED

Multi-Information Display

Headlight Auto Off Timer

The headlights, parking lights, side marker lights, taillights, and license plate lights go off after the selected time when you close the driver's door and take the remote with you. To change how long the lights stay on before they go off, follow these instructions:



While LIGHTING SETUP is shown in the CUSTOMIZE GROUP of the multi-information display, press the SEL/RESET button. The screen changes to CUSTOMIZE MENU. Press the INFO (▲/▼) button until you see the above display.

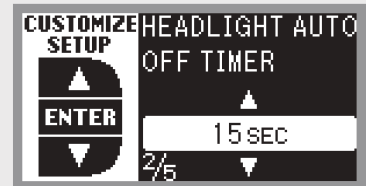

Press the SEL/RESET button. The screen changes as shown above. Select how long you want the lights to stay on before they go off (0, 15, 30, or 60 seconds) by pressing the INFO (▲/▼) button, then press the SEL/RESET button to enter your selection.

Multi-Information Display

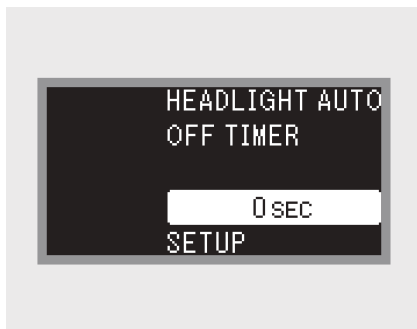

When your choice is set, you will see the above display for several seconds, then the screen goes back to CUSTOMIZE MENU.

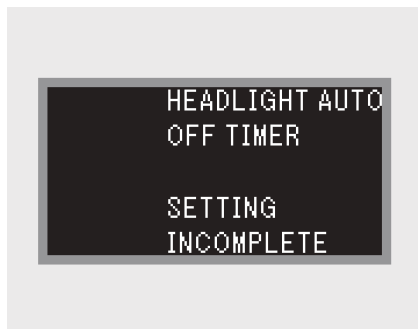

If your choice is not set, you will see the above display for several seconds, then the screen goes back to CUSTOMIZE MENU. If this happens, you need to repeat the same procedure.

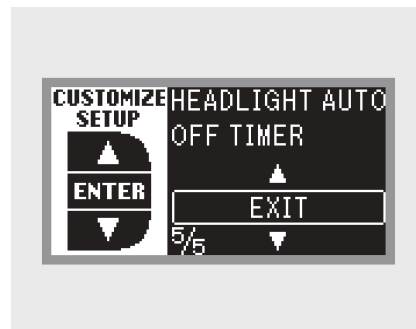

To exit HEADLIGHT AUTO OFF TIMER, select EXIT by pressing the INFO (▲/▼) button, then press the SEL/RESET button. The screen goes back to CUSTOMIZE MENU.

CONTINUED

Multi-Information Display

Door Setup

Here are the five custom settings for the door setup:

- AUTO DOOR LOCK
- DOOR LOCK MODE
- KEYLESS LOCK ACKNOWLEDGEMENT
- SECURITY RELOCK TIMER
- AUTO DOOR UNLOCK

While CUSTOMIZE GROUP is shown on the multi-information display, select DOOR SETUP by pressing INFO (▲/▼) button, then press the SEL/RESET button.

Each time you press the INFO (▲/▼) button, the screen changes as shown in the illustration. Press the INFO (▲/▼) button until you see the setting you want to customize, then press the SEL/RESET button to enter your selection.

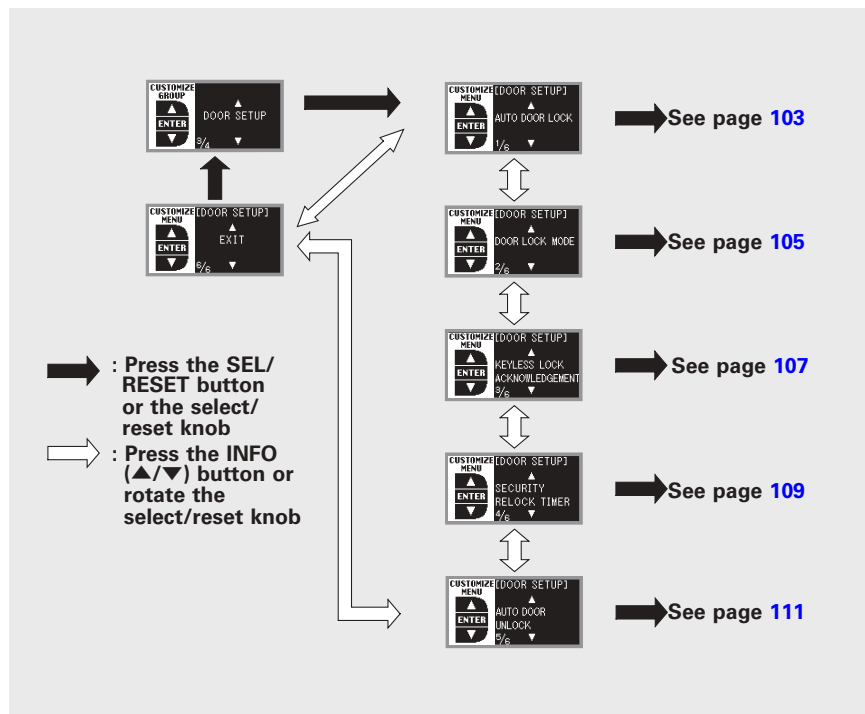

Multi-Information Display

Auto Door Lock

There are three settings you can choose from:

OFF –

The auto door lock is deactivated all the time.

WITH VEH SPD –

The doors lock when the vehicle speed reaches about 9 mph (about 15 km/h).

SHIFT FROM P –

The doors lock whenever you move the shift lever out of Park.



While DOOR SETUP is shown in the CUSTOMIZE GROUP of the multi-information display, press the SEL/RESET button. You will see the above display.



Press the SEL/RESET button. The screen changes as shown above. Select the desired setting by pressing the INFO (▲/▼) button, then press the SEL/RESET button to enter your selection.

CONTINUED

Multi-Information Display



When your choice is set, you will see the above display for several seconds, then the screen goes back to CUSTOMIZE MENU.

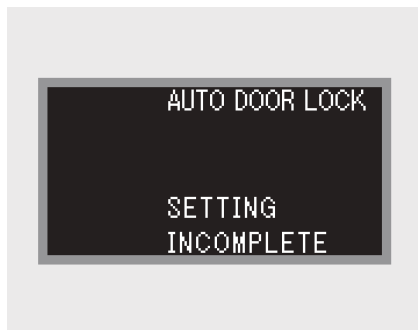

If your choice is not set, you will see the above display for several seconds, then the screen goes back to CUSTOMIZE MENU. If this happens, you need to repeat the same procedure.

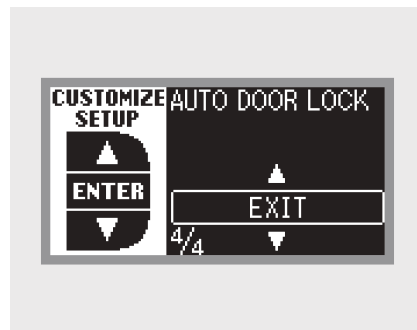

To exit AUTO DOOR LOCK without changing the current setting, select EXIT by pressing the INFO (▲/▼) button, then press the SEL/RESET button. The screen goes back to CUSTOMIZE MENU.

Multi-Information Display

Door Lock Mode

To select whether the driver's door unlocks or all the doors unlock when you unlock the doors with the remote transmitter or the key, follow these instructions.



While DOOR SETUP is shown in the CUSTOMIZE GROUP of the multi-information display, press the SEL/RESET button. The screen changes to CUSTOMIZE MENU. Press the INFO (▲/▼) button until you see the above display.



Press the SEL/RESET button. The screen changes as shown above. Select DRIVER DOOR or ALL DOORS by pressing the INFO (▲/▼) button, then press the SEL/RESET button to enter your selection.

CONTINUED

Multi-Information Display



When your choice is set, you will see the above display for several seconds, then the screen goes back to CUSTOMIZE MENU.



If your choice is not set, you will see the above display for several seconds, then the screen goes back to CUSTOMIZE MENU. If this happens, you need to repeat the same procedure.

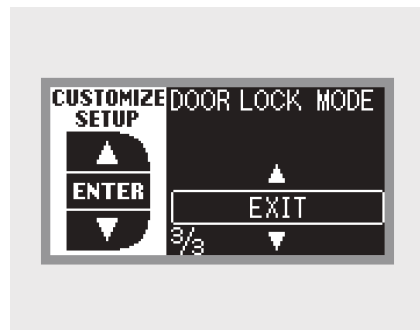

To exit DOOR LOCK MODE without changing the current setting, select EXIT by pressing the INFO (▲/▼) button, and then press the SEL/RESET button. The screen goes back to CUSTOMIZE MENU.

Multi-Information Display

Keyless Lock Acknowledgement

When you press the UNLOCK button on the remote transmitter to unlock the doors and the tailgate, the exterior lights blink twice to verify that the doors and the tailgate are unlocked and the security system is turned off.

When you push the LOCK button on the remote transmitter, some exterior lights flash, and a beeper sounds when you push the LOCK button again within 5 seconds to verify that the doors and the tailgate are locked and the security system has set (see page 130). You can customize the exterior lights not to flash and the beeper not to sound.



While DOOR SETUP is shown in the CUSTOMIZE GROUP of the multi-information display, press the SEL/RESET button. The screen changes to CUSTOMIZE MENU. Press the INFO (▲/▼) button until you see the above display.

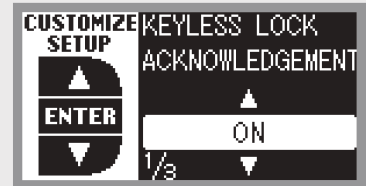

Press the SEL/RESET button. The screen changes as shown above. Select ON or OFF by pressing the INFO (▲/▼) button, then press the SEL/RESET button to enter your selection.

CONTINUED

Multi-Information Display

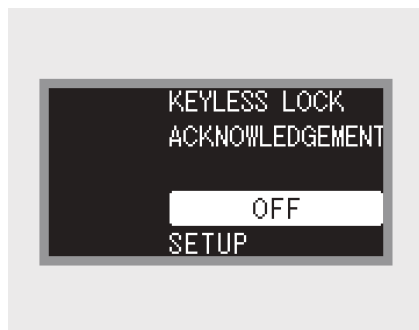

When your choice is set, you will see the above display for several seconds, then the screen goes back to CUSTOMIZE MENU.

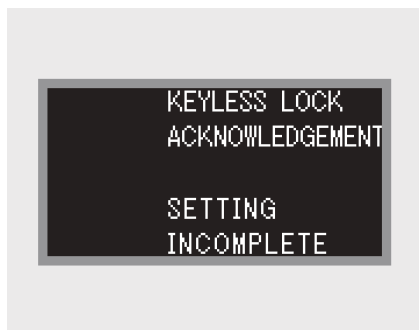

If your choice is not set, you will see the above display for several seconds, then the screen goes back to CUSTOMIZE MENU. If this happens, you need to repeat the same procedure.

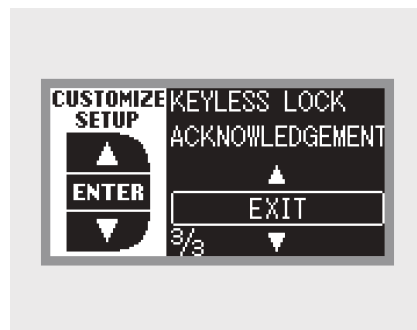

To exit KEYLESS LOCK ACKNOWLEDGEMENT without changing the current setting, select EXIT by pressing the INFO (▲/▼) button, then press the SEL/RESET button. The screen goes back to CUSTOMIZE MENU.

Multi-Information Display

Security Relock Timer

If you unlock the doors and the tailgate with the remote transmitter, but do not open any of the doors or the tailgate within 30 seconds, the doors and the tailgate automatically relock and the security system sets.

You can change this relock time from 30 seconds to 60 or 90 seconds.



While DOOR SETUP is shown in the CUSTOMIZE GROUP of the multi-information display, press the SEL/RESET button. The screen changes to CUSTOMIZE MENU. Press the INFO (▲/▼) button until you see the above display.

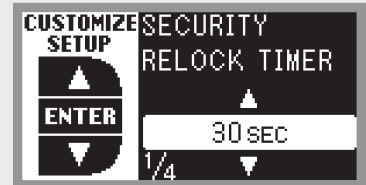

Press the SEL/RESET button. The screen changes as shown above. Select the relock time you want (30, 60, or 90 seconds) by pressing the INFO (▲/▼) button, then press the SEL/RESET button to enter your selection.

CONTINUED

Multi-Information Display

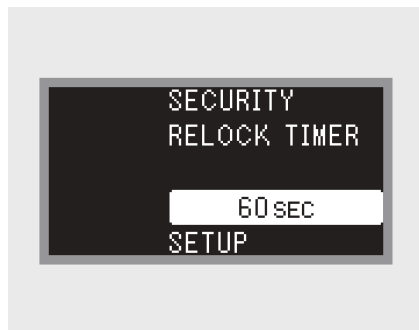

When your choice is set, you will see the above display for several seconds, then the screen goes back to CUSTOMIZE MENU.

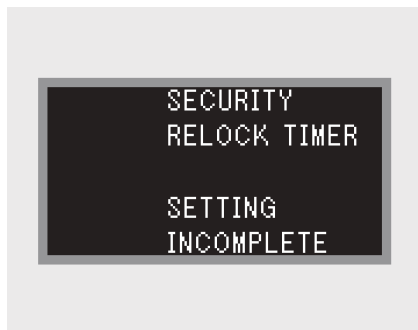

If your choice is not set, you will see the above display for several seconds, then the screen goes back to CUSTOMIZE MENU. If this happens, you need to repeat the same procedure.

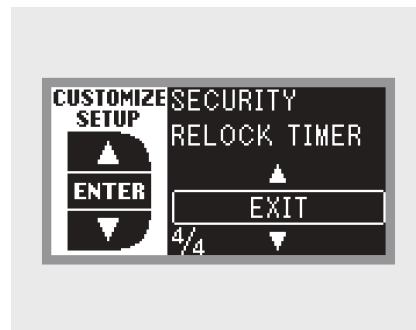

To exit SECURITY RELOCK TIMER without changing the current setting, select EXIT by pressing the INFO (▲/▼) button, then press the SEL/RESET button. The screen goes back to CUSTOMIZE MENU.

Multi-Information Display

Auto Door Unlock

There are three settings you can choose from:

SHIFT TO P – The driver's door or all the doors unlock when you move the shift lever to Park.

IGN OFF – The driver's door or all the doors unlock when you turn the ignition switch to the LOCK (0) position.

OFF – The auto door unlock mode is deactivated all the time.



While DOOR SETUP is shown in the CUSTOMIZE GROUP of the multi-information display, press the SEL/RESET button. The screen changes to CUSTOMIZE MENU. Press the INFO (▲/▼) button until you see the above display.

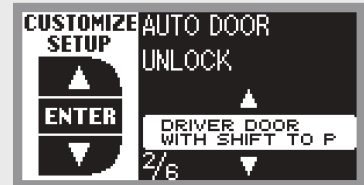

Press the SEL/RESET button. The screen changes as shown above. Select the desired setting by pressing the INFO (▲/▼) button, then press the SEL/RESET button to enter your selection.

CONTINUED

Multi-Information Display



When your choice is set, you will see the above display for several seconds, then the screen goes back to CUSTOMIZE MENU.

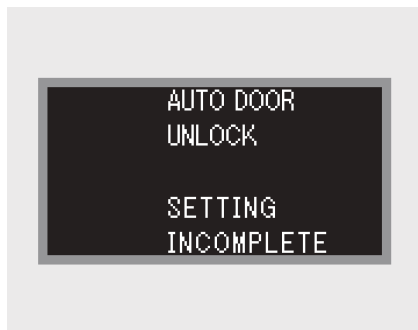

If your choice is not set, you will see the above display for several seconds, then the screen goes back to CUSTOMIZE MENU. If this happens, you need to repeat the same procedure.

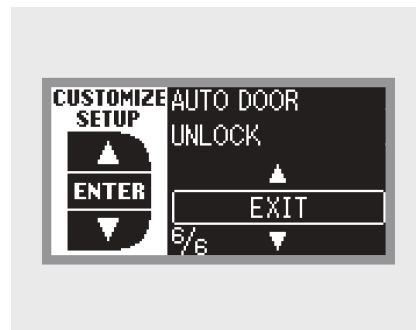

To exit AUTO DOOR UNLOCK without changing the current setting, select EXIT by pressing the INFO (▲/▼) button, then press the SEL/RESET button. The screen goes back to CUSTOMIZE MENU.

Controls Near the Steering Wheel

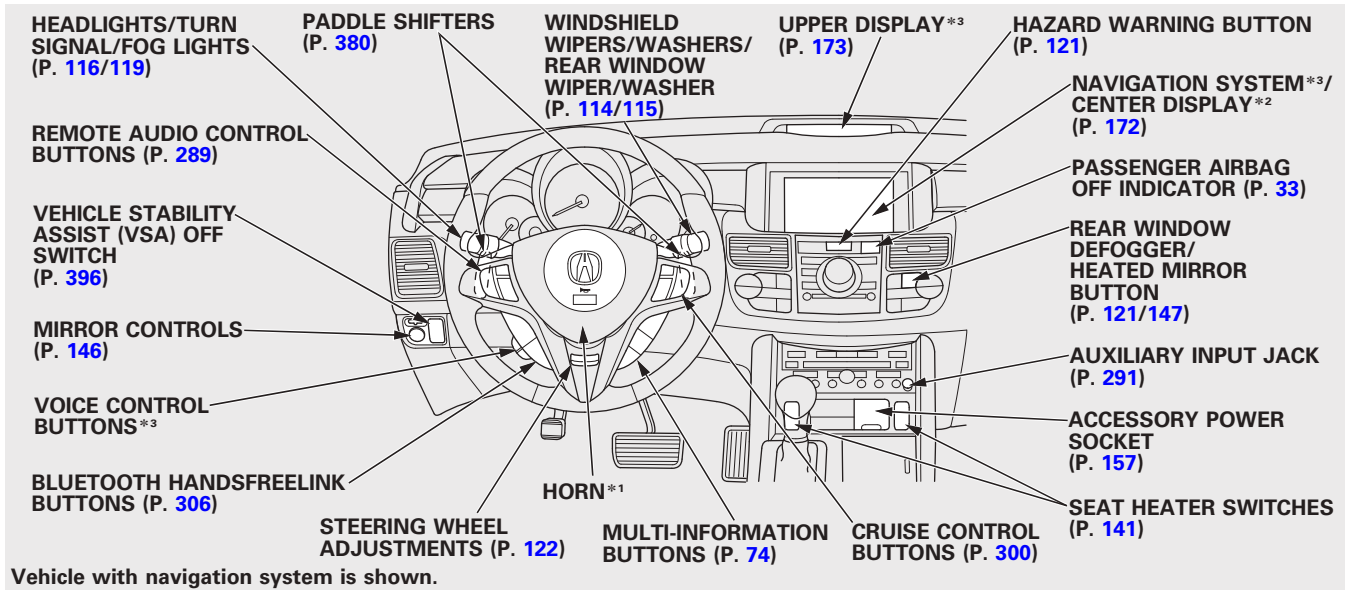

* 1: To use the horn, press the center pad of the steering wheel.

* 2: On models without navigation system.

* 3: Only on vehicles equipped with navigation system. Refer to the navigation system manual.

Windshield Wipers and Washers

Windshield Wiper

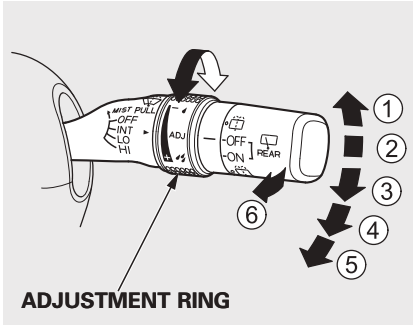

1. MIST
2. OFF
3. INT – Intermittent
4. LO – Low speed
5. HI – High speed
6. Windshield washers

Push the right lever up or down to select a position.

MIST – The wipers run at high speed until you release the lever.

OFF – The wipers are not activated.

INT – The length of the wiper interval is varied automatically according to the vehicle's speed.

Vary the delay by turning the adjustment ring. If you turn it to the shortest delay (☂ position), the wipers change to low speed operation when the vehicle speed exceeds 12 mph (20 km/h).

While the vehicle is stopped and in gear, the wipers sweep the windshield whenever you remove your foot from the brake pedal.

LO – The wipers run at low speed.

HI – The wipers run at high speed.

Windshield Washers – Pull the wiper control lever toward you, and hold it. The washers spray until you release the lever. The wipers run at low speed, then complete one more sweep after you release the lever.

Rear Window Wiper and Washer

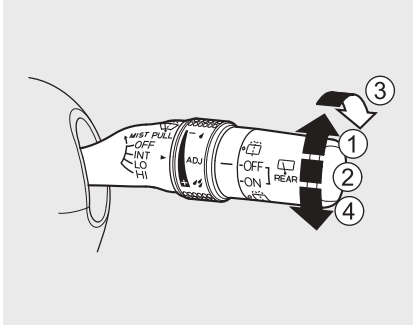

1. ON
2. OFF
3. Rear Window Washer with Wiper
4. Rear Window Washer Only.

ON – Rotate the switch clockwise to turn the rear window wiper ON. The wiper operates intermittently.

OFF – The wiper is not activated. When you turn the wiper switch to OFF while the rear window wiper is in action, it will return to its parked position.

When you shift the transmission to the reverse position with the front windshield wipers activated, the rear window wiper operates automatically. When the wiper control lever position is INT, the rear wiper operates intermittently. When it is LO or HI, the rear wiper operates continuously.

Rear Window Washer with Wiper – Hold past ON to turn the rear window wiper on and to spray the rear window washer. The rear window wiper makes one more sweep after you release the switch.

Rear Window Washer Only – Rotate the switch counterclockwise from OFF to spray the window washer without activating the wiper. The washer will operate until you release the switch.

The rear window washer uses the same fluid reservoir as the windshield washer.

Turn Signals and Headlights

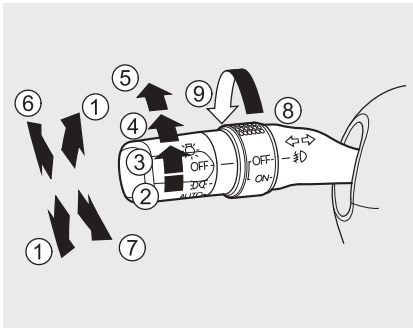

1. Turn signal
2. Off
3. Parking and interior lights
4. AUTO
5. Headlights on
6. High beams
7. Flash high beams
8. Fog lights off
9. Fog lights on

Turn Signal – Push down on the lever to signal a left turn and up to signal a right turn. To signal a lane change, push lightly on the lever, and hold it. The lever will return to center when you release it or complete a turn.

Headlights – Turning the switch to the “ D ” position turns on the parking lights, taillights, instrument panel lights, side-marker lights, and rear license plate lights.

Turning the switch to the “ D ” position turns on the headlights.

When the light switch is in the “ D ” or “ D ” position, the lights on indicator comes on as a reminder. This indicator stays on if you leave the light switch on and turn the ignition switch to the ACCESSORY (I) or the LOCK (0) position.

If you leave the lights on with the key removed from the ignition switch, you will hear a reminder beeper when you open the driver's door.

High Beams – Push the lever forward and the high beam indicator will come on (see page 69). Pull it back to return to low beams.

To flash the high beams, pull the lever back lightly, then release it. The high beams will stay on as long as you hold the lever back.

AUTO – The automatic lighting feature turns on the headlights and all other exterior lights when it senses low ambient light.

To turn on automatic lighting, turn the light switch to AUTO. The lights will come on automatically when the outside light level becomes low (at dusk, for example). The lights on indicator comes on as a reminder. The lights and indicator will turn off automatically when the system senses high ambient light.

The lights will remain on when you turn off the ignition switch. They will turn off automatically when you remove the key and open the driver's door. To turn them on again, either turn the ignition switch to the ON (II) position or turn the light switch to the  position.

CONTINUED

Turn Signals and Headlights

Even with the automatic lighting feature turned on, we recommend that you turn on the lights manually when driving at night or in a dense fog, or when you enter dark areas such as long tunnels or parking facilities.

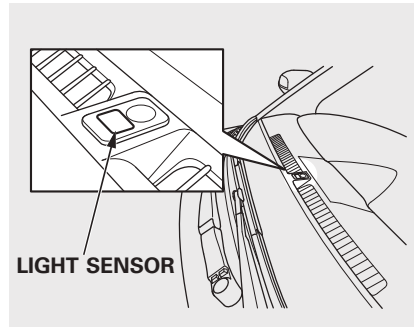

Do not leave the light switch in AUTO if you will not be driving the vehicle for an extended period (a week or more). You should also turn off the lights if you plan to leave the engine idling or off for a long time.



The automatic lighting feature is controlled by a sensor located on top of the dashboard. Do not cover this sensor or spill liquids on it.

Automatic Lighting Off Feature

This feature turns off the headlights, fog lights, parking lights, taillights, side marker lights, license plate lights, and instrument panel lights within 15 seconds of removing the key from the ignition switch and closing the driver's door.

The automatic lighting off feature activates if you leave the headlight switch in the “ ” or “ ” position or if the lights are turned on by setting the switch in the “AUTO” position, and you remove the key, then open and close the driver's door.

If you remove the key from the ignition switch with the headlight switch on, but do not open the door, the lights will turn off after 10 minutes.

The lights will turn on again when you unlock or open the driver's door. If you unlock the door, but do not open it within 15 seconds, the lights will go off. With the driver's door open, you will hear a lights on reminder beeper.

You can change the "HEADLIGHT AUTO OFF TIMER" setting on the multi-information display (see page [100](#)).

Daytime Running Lights

With the headlight switch off or in the  position, the high beam headlights and the high beam indicator come on with reduced brightness when you turn the ignition switch to the ON (II) position and release the parking brake. They remain on until you turn the ignition switch off, even if you set the parking brake.

The headlights revert to normal operation when you turn them on with the switch.

If you see a "CHECK DRL SYSTEM" message on the multi-information display, there is a problem with the daytime running light system. Take your vehicle to a dealer to have it checked.

Fog Lights

Turn the fog lights on and off by turning the switch next to the headlight switch.

You can use the fog lights only when the headlights are on low beam. They will go off when the headlights are turned off.

Instrument Panel Brightness

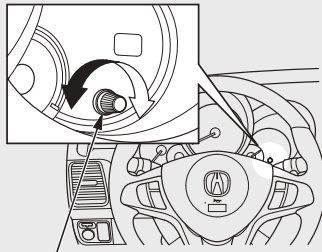



INSTRUMENT PANEL BRIGHTNESS CONTROL KNOB

The knob on the instrument panel controls the brightness of the instrument panel lights. Turn the knob to adjust the brightness. Separate adjustments can be made when the headlights are on and off.

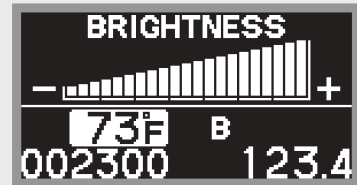
You will hear a beep when maximum or minimum brightness is reached. You will also hear a beep when the maximum level is canceled by turning the knob a click to the left.



U.S. model is shown

To reduce glare at night, the instrument panel illumination dims when you turn the light switch to the  or  position.

The level of brightness is shown on the multi-information display while you adjust it. It goes out 5 seconds after you finish adjusting.

Rear Window Defogger, Hazard Warning Button

Rear Window Defogger

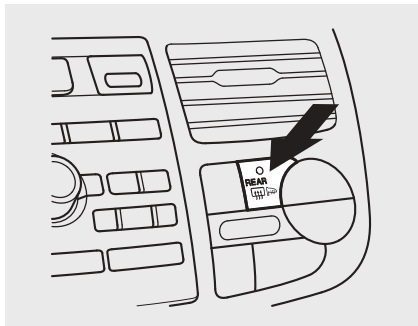

The rear window defogger clears fog, frost, and thin ice from the window. Push the defogger button to turn it on and off. The indicator in the button comes on to show the defogger is on. If you do not turn it off, the defogger will shut itself off within about 5 to 30 minutes according to the outside temperature. It also shuts off when you turn off the ignition switch. You have to turn it on again when you restart the vehicle.

In cold weather, the defogger will not automatically shut itself off. You must manually shut off the rear window defogger when it is no longer needed.

Make sure the rear window is clear and you have good visibility before starting to drive.

The defogger wires on the inside of the rear window can be accidentally damaged. When cleaning the glass, always wipe side-to-side.

Hazard Warning Button

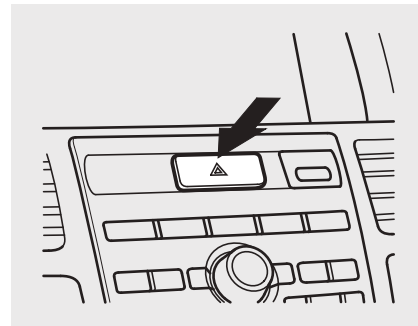

Push the button between the center vents to turn on the hazard warning lights (four-way flashers). This causes all outside turn signals and both indicators in the instrument panel to flash. Use the hazard warning lights if you need to park in a dangerous area near heavy traffic, or if your vehicle is disabled.

Steering Wheel Adjustments, Keys and Locks

Steering Wheel Adjustments

Make any steering wheel adjustments before you start driving.

⚠ WARNING

Adjusting the steering wheel position while driving may cause you to lose control of the vehicle and be seriously injured in a crash.

Adjust the steering wheel only when the vehicle is stopped.

1. Push the lever under the steering column all the way down.
2. Move the steering wheel up or down, and in or out, so it points toward your chest, not toward your face. Make sure you can see the instrument panel gauges and indicators.

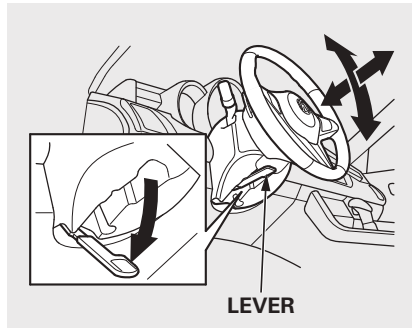

3. Push the lever up to lock the steering wheel in position.
4. Make sure you have securely locked the steering wheel in place by trying to move it up, down, in, and out.

Keys and Locks

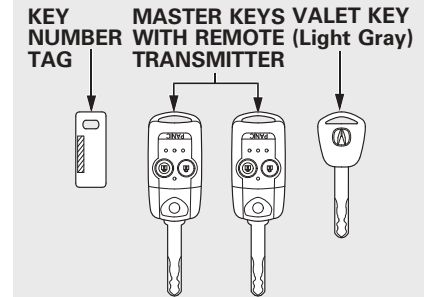

The master key fits all the locks on your vehicle. The valet key works only in the ignition and the door locks. You can keep the glove box and console compartment locked when you leave your vehicle and the valet key at a parking facility.

You should have received a key number tag with your keys. You will need this key number if you ever have to get a lost key replaced. Use only Acura-approved key blanks.

These keys contain electronic circuits that are activated by the immobilizer system. They will not work to start the engine if the circuits are damaged.

- Protect the keys from direct sunlight, high temperature, and high humidity.
- Do not drop the keys or set heavy objects on them.
- Keep the keys away from liquids. If they get wet, dry them immediately with a soft cloth.

The valet key does not contain a battery. Do not try to take it apart.

Retractable Master Key

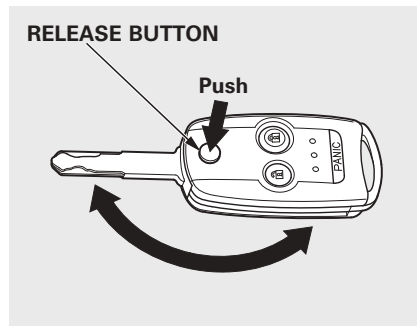

The master key can be retracted into the remote transmitter. To use the key, push the release button to release the key from the transmitter. The key should be fully extended. To retract the key, push the release button and at the same time push the key into the remote transmitter until it is securely latched.

Always use the fully-extended key when you insert it to the ignition switch. If the key does not fully extend, the immobilizer system may not operate properly and may prevent the engine from starting.

The key may come in contact with your finger while being retracted or extended. Make sure your fingers do not touch the pivot of the key when retracting or extending the key.

Immobilizer System

The immobilizer system protects your vehicle from theft. If an improperly coded key (or other device) is used, the engine's fuel system is disabled.

When you turn the ignition switch to the ON (II) position, the immobilizer system indicator should come on briefly, then go off. If the indicator starts to blink, it means the system does not recognize the coding of the key. Turn the ignition switch to the LOCK (0) position, remove the key, reinsert it, and turn the ignition switch to the ON (II) position again.

The system may not recognize your key's coding if another immobilizer key or other metal object (i.e. key chain) is near the ignition switch when you insert the key.

If the system repeatedly does not recognize the coding of your key, contact your dealer.

Do not attempt to alter this system or add other devices to it. Electrical problems could result that may make your vehicle inoperable.

If you have lost your key and cannot start the engine, contact your dealer.

NOTICE

Always take the ignition key with you whenever you leave the vehicle alone.

As required by the FCC:

This device complies with Part 15 of the FCC rules. Operation is subject to the following two conditions: (1) This device may not cause harmful interference, and (2) this device must accept any interference received, including interference that may cause undesired operation.

Changes or modifications not expressly approved by the party responsible for compliance could void the user's authority to operate the equipment.

This device complies with Industry Canada Standard RSS-210. Operation is subject to the following two conditions: (1) this device may not cause interference, and (2) this device must accept any interference that may cause undesired operation of the device.

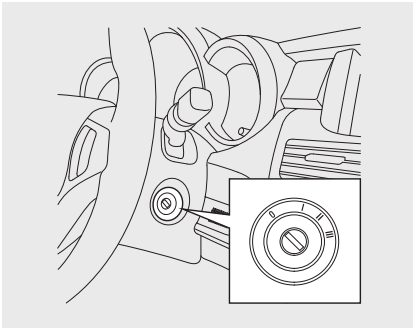

The ignition switch has four positions: LOCK (0), ACCESSORY (I), ON (II), and START (III).

LOCK (0) – You can insert or remove the key only in this position. To turn the key, the shift lever must be in Park, and you must push the key in slightly.

If the front wheels are turned, the anti-theft lock may make it difficult to turn the key. Firmly turn the steering wheel to the left or right as you turn the key.

ACCESSORY (I) – You can operate the audio system and the accessory power sockets in this position.

ON (II) – This is the normal key position when driving. Several of the indicators on the instrument panel come on as a test when you turn the ignition switch from the ACCESSORY (I) to the ON (II) position.

START (III) – Use this position only to start the engine. The switch returns to the ON (II) position when you let go of the key.

You will hear a reminder beeper if you leave the key in the ignition switch in the LOCK (0) or the ACCESSORY (I) position and open the driver's door. Remove the key to turn off the beeper.

You will also see a “REMOVE KEY” message on the multi-information display (see page 80).

The shift lever must be in Park before you can remove the key from the ignition switch.

Door Locks

Power Door Locks

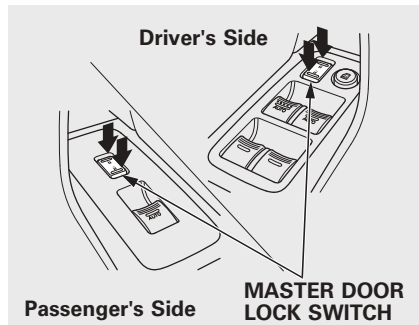

Each front door has a master door lock switch. Either switch locks and unlocks all doors and the tailgate. Push the top of the switch to lock all doors and the tailgate; push the bottom to unlock them.

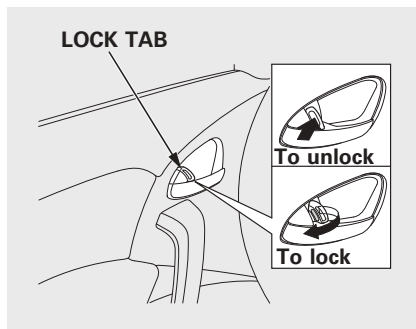

Each door has a lock tab next to the inside door handle. When you pull backward on the lock tab on the driver's door, all the doors and the tailgate lock. Pushing forward on the lock tab on the driver's door unlocks only that door. The lock tab on each passenger's door locks and unlocks only that door.

When the door is unlocked, you can see the red indicator on the lock tab next to the inside door handle.

All doors and the tailgate can be locked from the outside by using the key in the driver's door lock. To unlock only the driver's door, insert the key, turn the key, and release it. The remaining doors and the tailgate unlock when you turn the key a second time within a few seconds.

You can change the "DOOR LOCK MODE" setting on the multi-information display (see page [105](#)).

When the vehicle speed reaches about 9 mph (about 15 km/h) or more, all the doors lock automatically.

You can change the “AUTO DOOR LOCK” setting on the multi-information display (see page 103).

When you shift to P after driving, the driver's door unlocks.

You can change the “AUTO DOOR UNLOCK” setting on the multi-information display (see page 111).

To lock any passenger's door when getting out of the vehicle, pull backward on the lock tab and close the door. To lock the driver's door, remove the key from the ignition switch and pull backward on the lock tab. Then close the door.

Lockout Prevention

With the driver's door open and the key in the ignition, both master door lock switches are disabled. They are not disabled if the driver's door is closed. Pushing the switch down on the open front passenger's door will lock all doors and the tailgate.

Childproof Door Locks

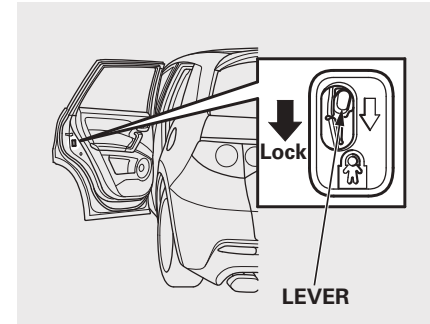

The childproof door locks are designed to prevent children seated in the rear from accidentally opening the rear doors. Each rear door has a lock lever near the edge. With the lever in the LOCK position (lever is down), the door cannot be opened from the inside regardless of the position of the lock tab. To open the door, push the lock tab forward and use the outside door handle.

Tailgate

The tailgate will lock when you lock the driver's door, and will unlock when you unlock all doors.

You can change the “DOOR LOCK MODE” setting on the multi-information display (see page 105).

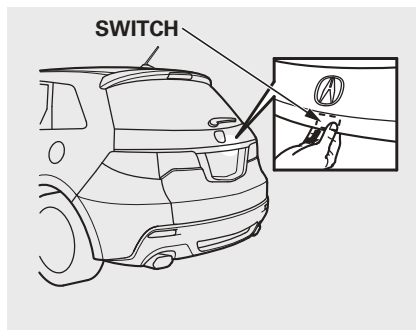

To open the tailgate, press and hold the switch, then lift up.

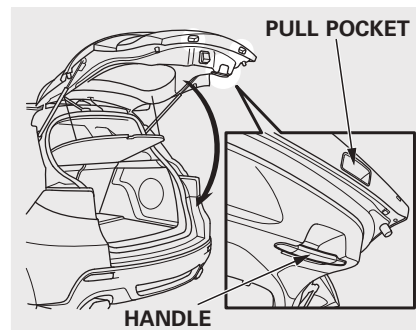

To close the tailgate, use the tailgate handle or the pull pockets to lower the tailgate, then press down on the back edge.

Keep the tailgate closed at all times while driving to avoid damaging the tailgate and to prevent exhaust gas from getting into the interior. See **Carbon Monoxide Hazard** on page 57.

Unlocking the Tailgate

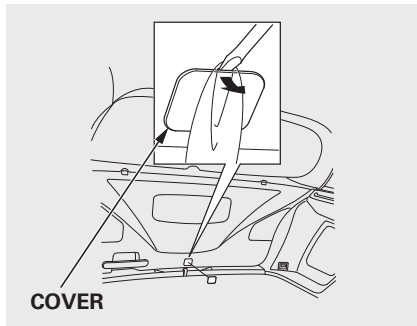

If the power door lock system cannot unlock the tailgate, unlock it manually.

Place a cloth on the top side of the cover to prevent scratches, then use a small flat-tip screwdriver to remove the cover on the back of the tailgate.

RELEASE LEVER

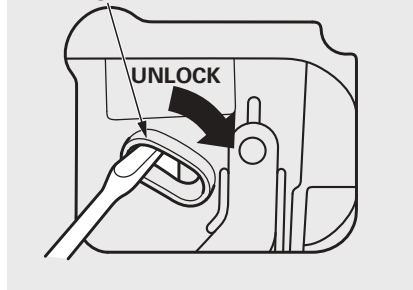

Push the release lever to the lower right as shown with the screw driver, then push and open the tailgate.

If you need to unlock the tailgate manually, it means there is a problem with the tailgate. Have the vehicle checked by your dealer.

Remote Transmitter

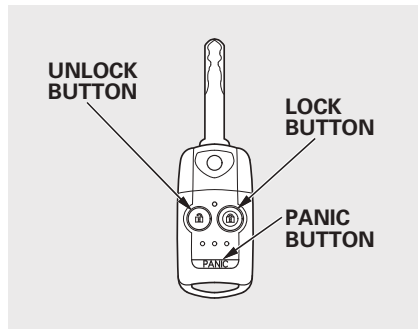

LOCK – Press this button once to lock all doors and the tailgate. Some exterior lights will flash. When you push LOCK twice within 5 seconds, you will hear a beep to verify that the doors and tailgate are locked and the security system has set. This button does not work if any door or tailgate is not fully closed.

To change the “KEYLESS LOCK ACKNOWLEDGEMENT” setting, see page [107](#).

UNLOCK – Press this button once to unlock the driver's door. Push it twice to unlock the other doors. Some exterior lights will flash twice when you push the button. If you do not open any door or the tailgate within 30 seconds, they will automatically relock.

To change the “DOOR LOCK MODE” setting, see page [105](#).

To change the “SECURITY RELOCK TIMER” setting, see page [109](#).

When you press the UNLOCK button, the ceiling lights (if the front and rear ceiling light switches are in the door activated position) will come on. If you do not open any door, the lights stay on for about 30 seconds, then fade out. If you relock the doors with the remote transmitter before 30 seconds have elapsed, the lights go off immediately.

To change the “INTERIOR LIGHT DIMMING TIME” setting, see page [98](#).

PANIC – Press this button for about 1 second to attract attention; the horn will sound, and the exterior lights will flash for about 30 seconds. To cancel panic mode, press any button on the remote transmitter, or turn the ignition switch to the ON (II) position.

Remote Transmitter Care

- Avoid dropping or throwing the transmitter.
- Protect the transmitter from extreme temperature.
- Do not immerse the transmitter in any liquid.
- If you lose a transmitter, the replacement needs to be reprogrammed by your dealer.

Replacing the Transmitter Battery

If it takes several pushes on the button to lock or unlock the doors and the tailgate, replace the battery as soon as possible.
Battery type: CR1616

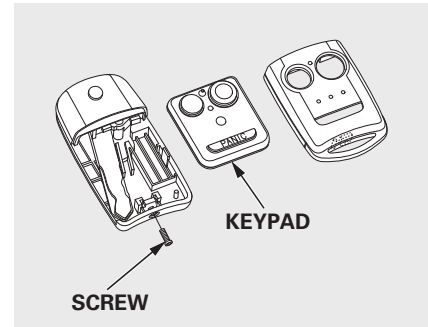

To replace the battery:

1. Remove the screw at the base of the transmitter with a small Phillips-head screwdriver.
2. Separate the keypad from the transmitter by pushing any button from outside.

CONTINUED

Remote Transmitter

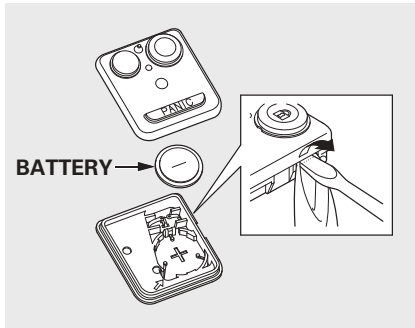

3. Place a cloth on the edge of the keypad to prevent scratches, and remove the upper half by carefully prying on the edge with a small flat-tip screwdriver.

4. Remove the old battery and note the polarity. Make sure the polarity of the new battery is the same (- side facing up), then insert it in the keypad.

An improperly disposed of battery can hurt the environment. Always confirm local regulations for battery disposal.

5. Snap the two halves of the keypad, then install the parts in reverse order.

As required by the FCC:

This device complies with Part 15 of the FCC rules. Operation is subject to the following two conditions: (1) This device may not cause harmful interference, and (2) this device must accept any interference received, including interference that may cause undesired operation.

Changes or modifications not expressly approved by the party responsible for compliance could void the user's authority to operate the equipment.

This device complies with Industry Canada Standard RSS-210.

Operation is subject to the following two conditions: (1) this device may not cause interference, and (2) this device must accept any interference that may cause undesired operating of the device.

Keyless Memory Settings™

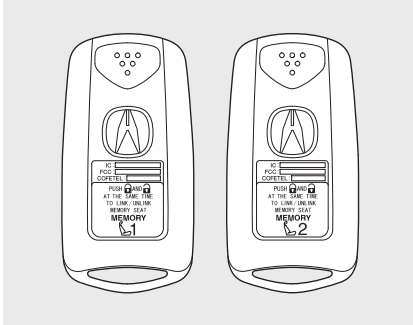

When you unlock the driver's door with your remote, each remote activates the keyless memory settings related to that remote. The driver's ID (MEMORY 1 or MEMORY 2) is shown on the back of each remote.

Here are the settings activated with the remote;

- Driving position memory (see page 148).

When you unlock and open the driver's door with the remote transmitter, the driver's seat (except the power lumbar feature) and outside mirrors start to move to the positions stored in memory. The indicator in the related memory button to the remote comes on.

To turn off this feature, press and hold the LOCK and UNLOCK buttons at the same time. The LED in the remote will blink twice. Then release the buttons. Doing this cancels the keyless memory settings for that remote.

To turn the keyless memory settings back on, repeat this procedure. The LED will blink once to indicate the feature has been turned on.

Seats

Front Seat Power Adjustments

See pages 13 – 14 for important safety information and warnings about how to properly position the seats and seat-backs.

The controls for the power adjustable front seats are on the outside edge of each seat bottom. You can adjust the seats with the ignition switch in any position. Make all seat adjustments before you start driving.

The passenger seat has the same adjustments as the driver's seat but without any height and lumbar adjustments.

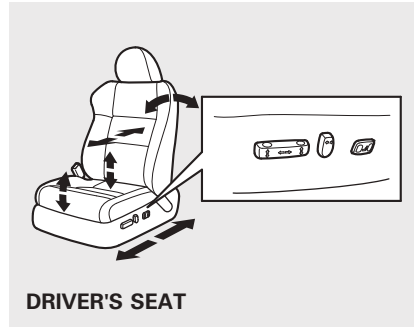

Moves the seat forward and backward.



Moves the front of the seat up or down. (Driver's seat only)



Raises or lowers the seat. (Driver's seat only)



Moves the whole seat up and forward, or down and backward. The front of the seat also tilts up or down at the same time. (Driver's seat only)



Adjusts the seat-back angle forward or backward.



Increases or decreases the lumbar support. (Driver's seat only)

Head Restraints

See page 15 for important safety information and a warning about improperly positioning head restraints.

Your vehicle is equipped with head restraints in all seating positions to help protect you and your passengers from whiplash and other injuries.

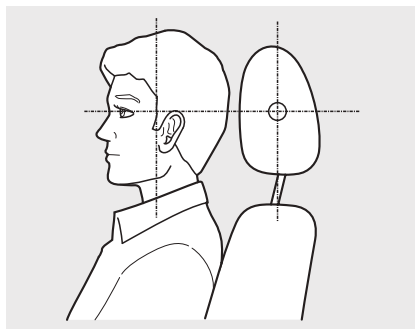

They are most effective when you adjust them so the center of the back of the occupant's head rests against the center of the restraint.

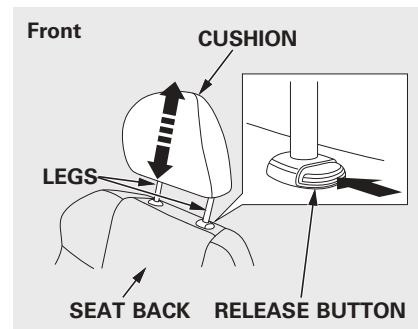

Adjusting the Head Restraint

The front and rear head restraints adjust for height. You need both hands to adjust the restraint. Do not attempt to adjust it while driving. To raise it, pull upward. To lower the restraint, push the release button and push the restraint down.

CONTINUED

Seats

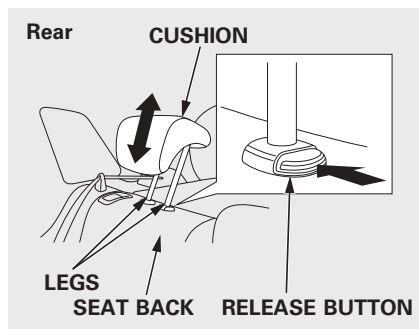

Removing the Head Restraint

To remove a head restraint for cleaning or repair, pull it up as far as it will go. Push the release button, then pull the restraint out of the seat-back.

When reinstalling a head restraint, put the legs back in place. Then adjust it to the appropriate height while pressing the release button.

Make sure the removed head restraints are securely stored.

⚠ WARNING

Failure to reinstall the head restraints can result in severe injury during a crash.

Always replace the head restraints before driving.

Active Head Restraints

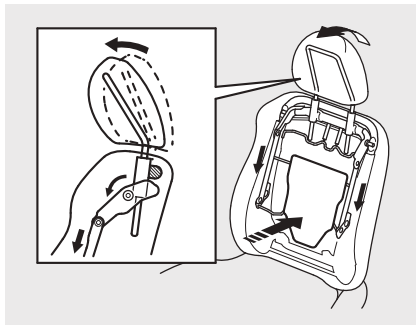

The driver's and front passenger's seats have active head restraints. If the vehicle is struck severely from the rear, the occupant properly secured with the seat belt will be pushed against the seat-back and the head restraint will automatically move forward.

This reduces the distance between the restraint and the occupant's head. It also helps protect the occupants against whiplash and injuries to the neck and upper spine.

After a collision, the activated restraint should return to its normal position.

If the restraints do not return to their normal position, or in the event of a severe collision, have the vehicle inspected by an Acura dealer.

For a head restraint system to work properly:

- Do not hang any items on the head restraints, or from the restraint legs.
- Do not place any object between an occupant and the seat-back.
- Install each restraint in its proper location.
- Only use genuine Acura replacement head restraints.

Seats

Armrests

Front

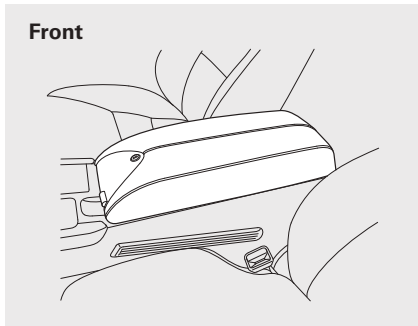

The lid of the console compartment can be used as an armrest.

Rear

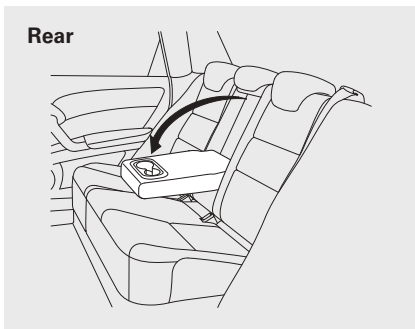

The rear seat armrest is in the center of the rear seat. Pivot it down to use it.

A beverage holder is located in the armrest.

Folding the Rear Seats Down

The rear seat-backs can be folded down to give more cargo room. Each side folds down separately. So you can still carry a passenger in the rear seat.

Remove any items from the seat before folding down the seat-back.

Make sure there are no items on the floor before folding down the seats.

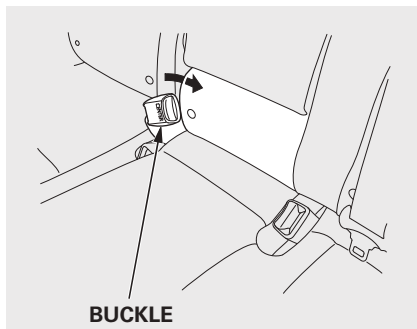

1. Move the front seats as far forward as possible. Make sure the front seat-backs are in the upright positions.
2. Store the center seat belt buckle into the pocket in the rear seat-back.
3. Lower the head restraints to their lowest positions.

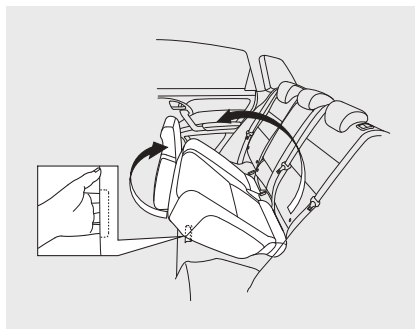

4. Push the armrest back in place.
5. Lift the front edge of the rear seat cushion, then pull up on the rear of the seat cushion, then fold the cushion forward.

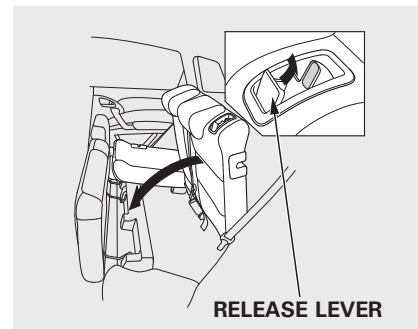

6. Pull up the release lever on the outside of the seat-back. Fold the seat-back forward.
7. Move the front seats backward to the desired position.

CONTINUED

Seats

Do not put any heavy items on the seat-back when it is folded down.

Make sure all items in the cargo area are secured. Loose items can fly forward and cause injury if you have to brake hard (See **Carrying Cargo** on page 364).

Make sure that the folded down rear seat does not interfere with the front passenger's seat-back. This will cause the front passenger's weight sensors and the front passenger's seat belt reminder indicator to work improperly (see pages 21 and 33). Also check the passenger airbag off indicator to assure proper operation of the passenger's front airbag.

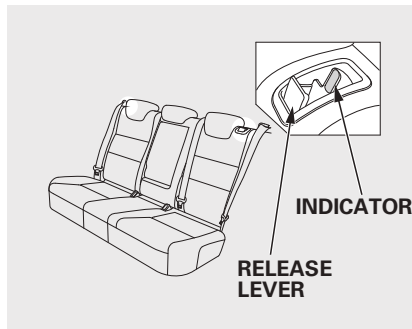

After returning the seat-back to the upright position, tug on the seat-back to make sure it is latched. If the seat-back is not latched fully, the seat belt will not work properly and you will see the red indicator behind the release lever as shown.

To return the seat cushion to its original position, lift up the seat cushion, then place the rear of the seat cushion at the base of the seat-back. Use the seat buckles as guides. Lower the front of the seat cushion until it locks into place.

Make sure the seat-back and seat cushion are locked securely and all rear shoulder belts are positioned in front of the rear seat-backs.

Passenger's Seat

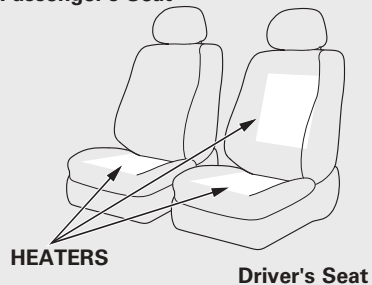

Both front seats are equipped with seat heaters. The passenger seat is only heated in the seat bottom because of the side airbag cutoff system.

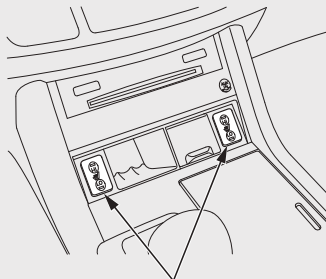

The ignition switch must be in the ON (II) position to use seat heaters. Push the top of the switch, HI, to rapidly heat up the seat. After the seat reaches a comfortable temperature, select LO by pushing the bottom of the switch. This will keep the seat warm.

In the HI setting, the heater turns off when the seat gets warm, and turns back on after the seat's temperature drops.

In the LO setting, the heater runs continuously. It does not cycle with temperature changes.

Follow these precautions whenever you use the seat heaters:

- Use the HI setting only to heat the seats quickly, because it draws large amounts of current from the battery.
- If the engine is left idling for an extended period, do not use the seat heaters, even on the LO setting. It can weaken the battery, causing hard starting.

Power Windows

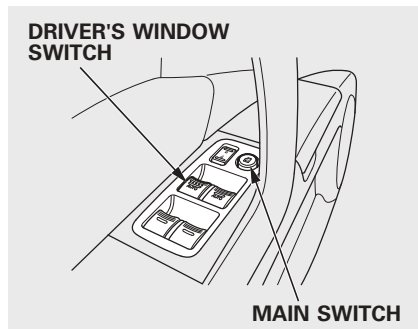

Turn the ignition switch to the ON (II) position to raise or lower any window. To open the window, push the switch down and hold it. Release the switch when you want to stop the window. To close the window, pull back on the switch and hold it.

The windows will operate for up to 10 minutes after you turn off the ignition switch. Opening either front door cancels this function.

⚠ WARNING

Closing a power window on someone's hands or fingers can cause serious injury.

Make sure your passengers are away from the windows before closing them.

When you push the MAIN switch in, the switch is off, and the passenger windows cannot be raised or lowered. To cancel this feature, push on the switch again to get it to pop out. Keep the MAIN switch off when you have children in the vehicle so they do not injure themselves by operating the windows unintentionally.

AUTO – To open or close either front window fully, push or pull the window switch firmly down or up to the second detent, and release it. The window will automatically go up or down all the way. To stop the window, pull or push the window switch briefly.

To open or close either front window partially, push down or pull back on the window switch lightly to the first detent and hold it. The window will stop when you release the switch.

AUTO REVERSE – If either front window senses any obstacle while it is closing automatically, it will reverse direction and then stop. To close the window, remove the obstacle, then use the window switch again.

Auto reverse stops sensing when the window is almost closed. You should always check that all passengers and objects are away from the window before closing it.

NOTE: The driver's window auto reverse function is disabled when you continuously pull up the switch.

Moonroof

Turn the ignition switch to the ON (II) position before operating the moonroof switch on the ceiling console.

To open the moonroof fully, pull back the moonroof switch firmly. The moonroof opens all the way. To stop the moonroof from opening fully, briefly move the switch in either direction.

To tilt the moonroof, push the center of the moonroof switch straight up. To stop the moonroof from tilting fully open, push the moonroof switch forward.

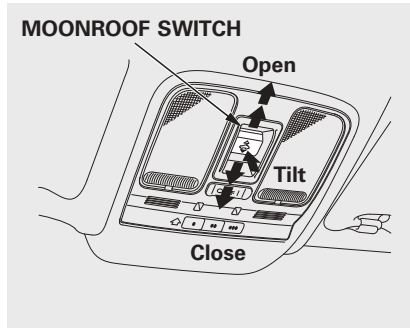

To open or close the moonroof partially, pull or push the moonroof switch lightly to the first detent and hold it. The moonroof will stop when you release the switch.

To close the moonroof fully, push the moonroof switch forward to the second detent, then release it. The moonroof closes all the way. To stop the moonroof from closing all the way, briefly move the switch in either direction.

⚠ WARNING

Opening or closing the moonroof on someone's hands or fingers can cause serious injury.

Make sure all hands and fingers are clear of the moonroof before opening or closing it.

The moonroof has a key-off delay. You can open and close the moonroof for up to 10 minutes after you turn off the ignition switch. The key-off delay cancels as soon as you open either front door. You must then turn the ignition switch to the ON (II) position for the moonroof to operate.

NOTICE

If you try to open the moonroof in below-freezing temperatures, or when it is covered with snow or ice, you can damage the moonroof panel or motor.

Auto Reverse

If the moonroof runs into any obstacle while it is closing automatically, it will reverse direction, and then stop. To close the moonroof, remove the obstacle, then use the moonroof switch again.

Auto reverse stops sensing when the moonroof is almost closed. You should always check that all passengers and objects are away from the moonroof before closing it.

Mirrors

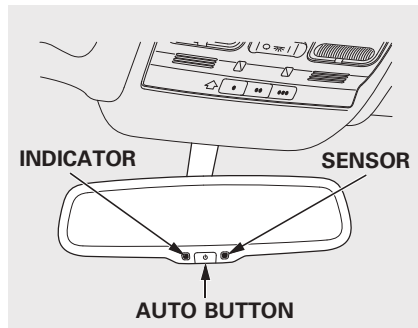

Keep the inside and outside mirrors clean and adjusted for best visibility. Be sure to adjust the mirrors before you start driving.

The inside mirror can automatically darken to reduce glare. To turn on this feature, press the button on the bottom of the mirror. The AUTO indicator comes on as a reminder. When it is on, the mirror darkens when it senses the headlights of a vehicle behind you, then returns to normal visibility when the lights are gone. Press the button again to turn off this feature.

NOTICE

There is also a sensor on the back of the mirror. Items hung on the mirror may block this sensor and affect its performance.

On models without navigation system
When you shift to reverse with the ignition switch in the ON (II) position, the rear view is shown on the left side of the inside mirror. For more information, see page [348](#).

Adjusting the Power Mirrors

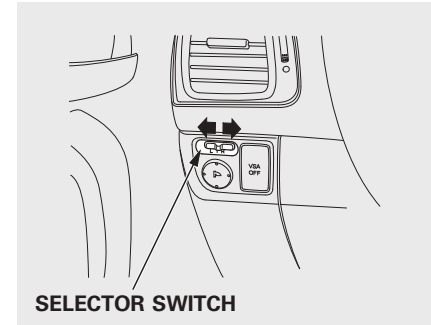

1. Turn the ignition switch to the ON (II) position.
2. Move the selector switch to L (driver's side) or R (passenger's side).

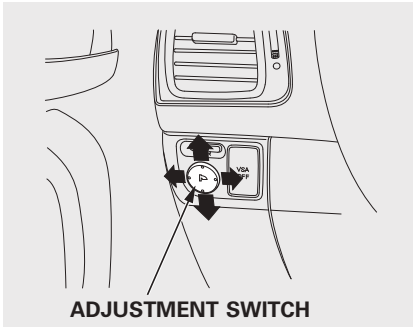

ADJUSTMENT SWITCH

3. Push the appropriate edge of the adjustment switch to move the mirror right, left, up, or down.
4. When you finish, move the selector switch to the center (off) position. This turns the adjustment switch off to keep your setting.

Outside mirror positions can be stored in the driving position memory system (see page 148).

Reverse Tilt Door Mirror

The passenger's outside mirror has a reverse tilt feature. When in reverse, the mirror will tilt down slightly to improve your view as you parallel park. Shifting out of reverse will return the mirror to its original position.

- To tilt the passenger mirror, place the selector switch in the right position.
- To turn the feature off, place the switch in the center or left position.

Heated Mirrors

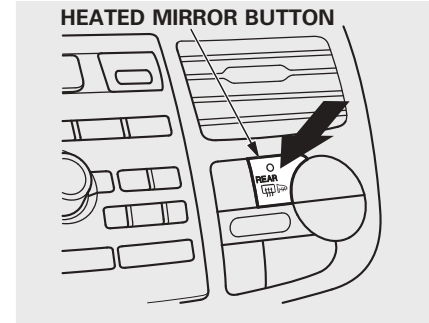

The outside mirrors are heated to remove fog and frost. With the ignition switch in the ON (II) position, turn on the heaters by pressing the button. The indicator in the button comes on as a reminder. Press the button again to turn the heaters off. Pressing this button also turns the rear window defogger on and off.

Driving Position Memory System

Your vehicle has a memory feature for the driver's seat and outside mirror positions.

Seat, except for power lumbar, and outside mirror positions, can be stored in separate memories. You select a memorized position by pushing the appropriate button or using the appropriate remote transmitter (Memory 1 or Memory 2).

Storing a Driving Position in Memory

Store a driving position only when the vehicle is parked.

1. Turn the ignition switch to the ON (II) position. You cannot add a new driving position to the memory unless the ignition switch is in the ON (II) position. You can recall a memorized position with the ignition switch in any position.
2. Adjust the seat to a comfortable position (see page [134](#)). Adjust the outside mirrors for best visibility (see page [146](#)).

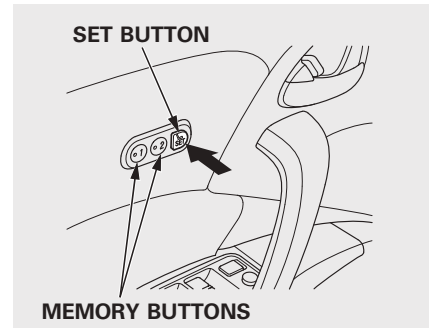

3. Press and release the SET button on the driver's door. You will hear a beep. Immediately press and hold one of the memory buttons (1 or 2) until you hear two beeps. The indicator in the memory button will come on. The current positions of the driver's seat and outside mirrors are now stored.

To cancel the storing procedure after pressing the SET button, do any of the following:

- Fail to press a memory button within 5 seconds.
- Readjust the seat position.
- Readjust the outside mirror position.

Each memory button stores only one driving position. Storing a new position erases the previous setting stored in that button's memory. If you want to add a new position while retaining the current one, use the other memory button.

Selecting a Memorized Position

To select a memorized position, do this:

1. Make sure the vehicle is parked.
2. Press the desired memory button (1 or 2) until you hear a beep, then release the button.

The system will move the seat and outside mirrors to the memorized positions. The indicator in the selected memory button will flash during movement. When the adjustments are complete, you will hear two beeps, and the indicator will remain on.

To stop the system's automatic adjustment, do any of these actions:

- Press any button on the control panel: SET, 1, or 2.
- Push any of the adjustment switches for the seat.
- Shift out of Park.
- Adjust the outside mirrors.

If desired, you can use the adjustment switches to change the positions of the seat or outside mirrors after they are in their memorized positions. If you change the memorized position, the indicator in the memory button will go out. To keep this driving position for later use, you must store it in the driving position memory.

Parking Brake

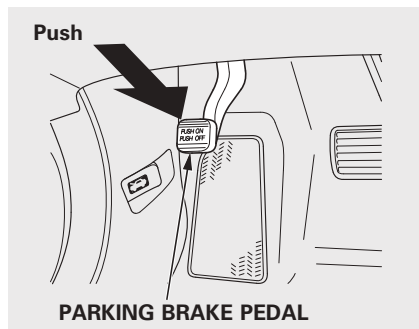

To apply the parking brake, push the pedal down with your foot. To release it, push on the pedal again. The parking brake indicator on the instrument panel should go out when the parking brake is fully released (see page [67](#)).

NOTICE

Driving the vehicle with the parking brake applied can damage the rear brakes and axles. A beeper will sound if the vehicle is driven with the parking brake on.

You will also see a “RELEASE PARKING BRAKE” message on the multi-information display (see page [79](#)).

Ceiling Lights

Front

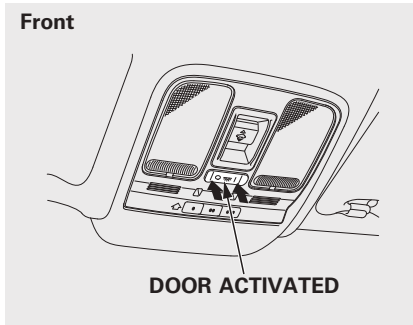

Each front and rear ceiling light has a three-position switch.

Front ceiling lights:

In the “I” position, both front and rear ceiling lights are on all the time except when the rear ceiling light switch is in the OFF position.

In the “O” position, both front and rear ceiling lights are off all the time.

With the front ceiling lights switch in this position, the rear ceiling light does not work, and both front and rear ceiling lights do not come on when you open any door.

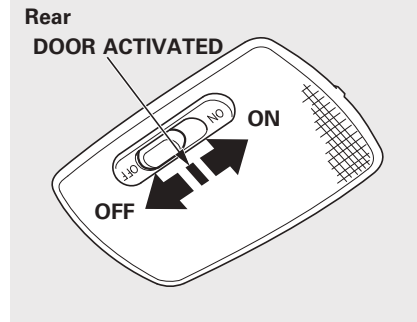

Rear ceiling light:

You can use the rear ceiling light independently. In the OFF position, the light does not come on even if the front ceiling light switch is in the “I” position. In the ON position, the light stays on continuously except when the front ceiling light switch is in the “O” position.

CONTINUED

Interior Lights

In the door activated position, both front and rear ceiling lights come on when you:

- Open any door.
- Remove the key from the ignition switch.
- Unlock the doors with the key, lock tab on the driver's door, master door lock switch, or remote transmitter.

After all doors are closed tightly, the light(s) dims slightly, then fades out in about 30 seconds.

If you do not open any door after unlocking the driver's door or removing the key from the ignition switch, the light(s) fade out in about 30 seconds. If you leave any door open without the key in the ignition switch, the light(s) will go off after 3 minutes.

To change the "INTERIOR LIGHT DIMMING TIME" setting, see page 98.

Individual Map Lights

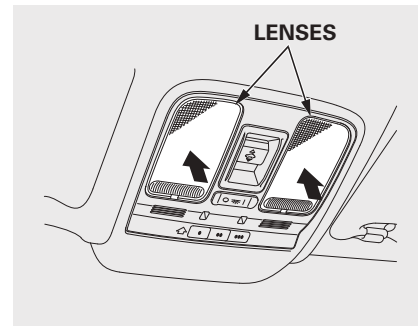

You can use the front ceiling lights whenever the lights are off. To turn a light on or off, push its lens.

Courtesy Lights

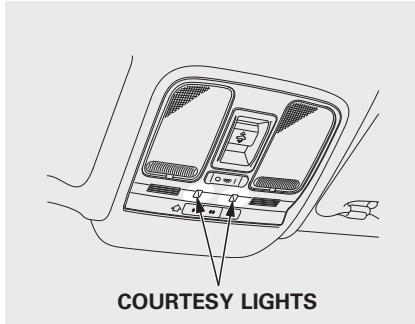

The courtesy lights in the ceiling console come on when the parking lights are turned on. You can adjust their brightness by turning the select/reset knob on the instrument panel.

In addition to the courtesy lights on the ceiling, the driver's and front passenger's ambient foot lights come on.

The courtesy light in each front door comes on when the door is opened, and goes out when the door is closed.

Your vehicle also has a courtesy light in the ignition switch. This light comes on when you:

- Open any door.
- Unlock the driver's door.
- Remove the key from the ignition switch.

After all doors are closed tightly, the light fades out in about 30 seconds.

To change the "INTERIOR LIGHT DIMMING TIME" setting, see page [98](#).

Cargo Area Light

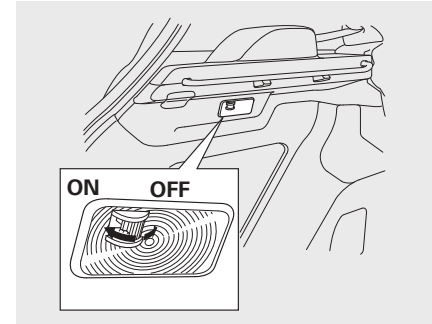

The cargo area light has a two position switch. In the OFF (right) position, the light does not come on. In the ON (left) position, the light comes on when you open the tailgate.

Interior Convenience Items

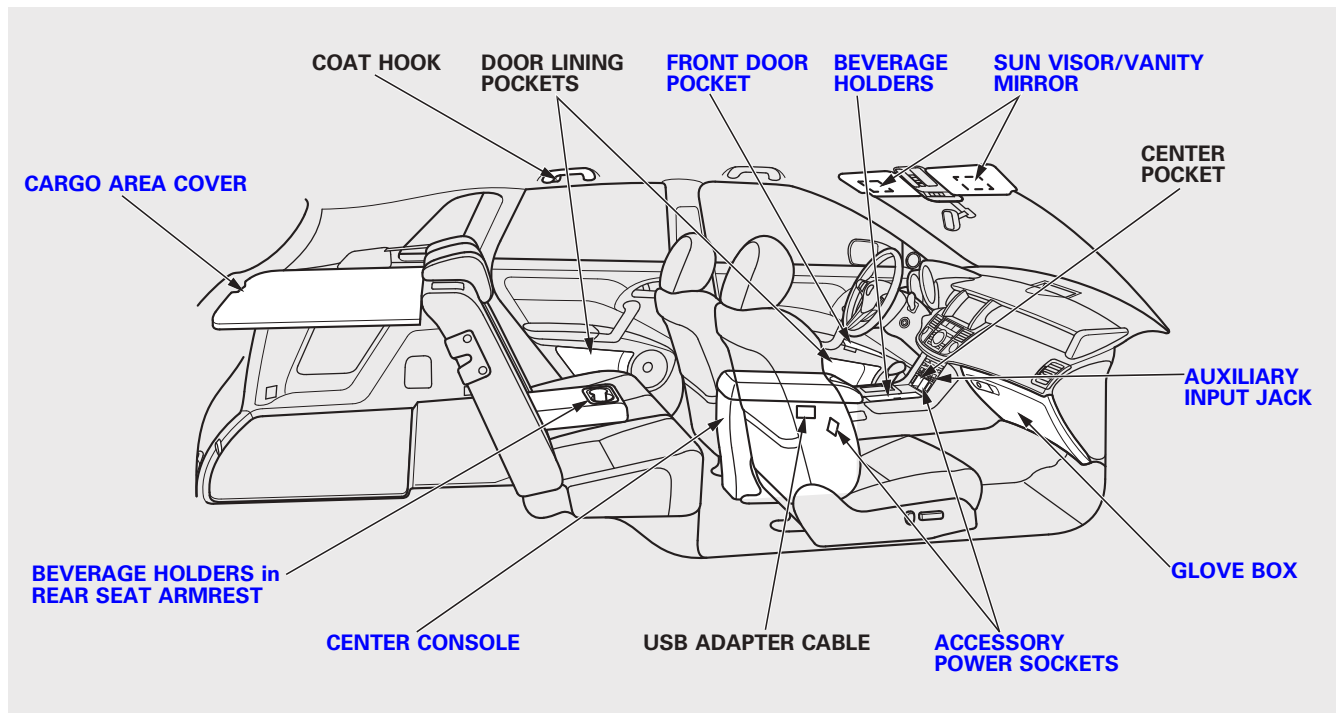

Glove Box

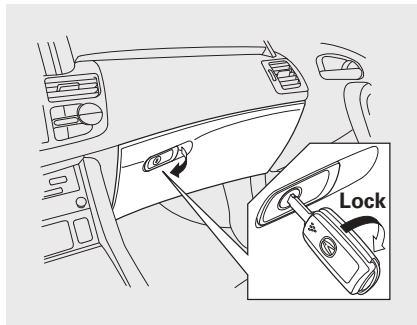

Open the glove box by pulling the handle to the left. Close it with a firm push. Lock or unlock the glove box with the master key.

⚠ WARNING

An open glove box can cause serious injury to your passenger in a crash, even if the passenger is wearing the seat belt.

Always keep the glove box closed while driving.

The glove box light comes on when the parking lights are on.

Front Door Pockets

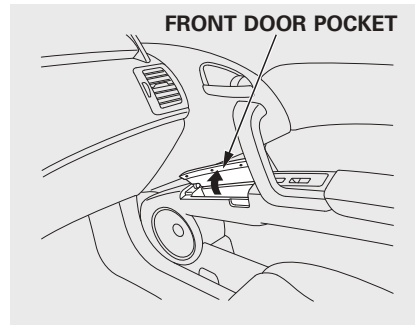

The interior of each front door has an extendable pocket for maps and other small, lightweight items. For safety, be sure both front door pockets are closed while driving.

Interior Convenience Items

Beverage Holders

Be careful when you are using the beverage holders. A spilled liquid that is very hot can scald you or your passengers. Spilled liquids can damage the upholstery, carpeting, and electrical components in the interior.

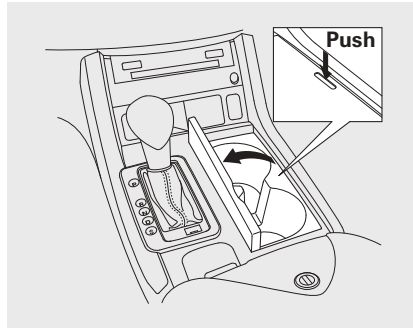

To use the front beverage holder, push on the lid. It will swing open. To close the lid, push it down until it latches.

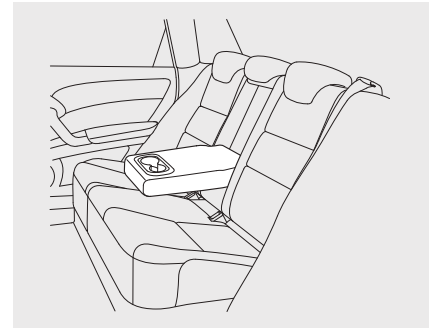

The rear seat also has a beverage holder in the center armrest. To use it, pivot the armrest down.

Accessory Power Sockets

Front

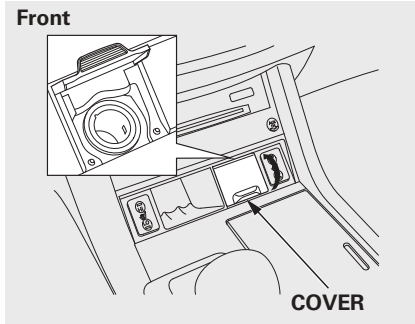

To use the accessory power socket, pull up the cover. The ignition switch must be in the ACCESSORY (I) or ON (II) position.

These sockets are intended to supply power for 12 volt DC accessories that are rated 120 watts or less (10 amps).

Console Compartment

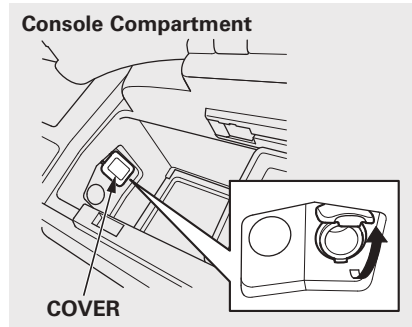

None of the sockets will power an automotive type cigarette lighter element. When both sockets are being used, the combined power rating of the accessories should be 120 watts or less (10 amps).

Sun Visor

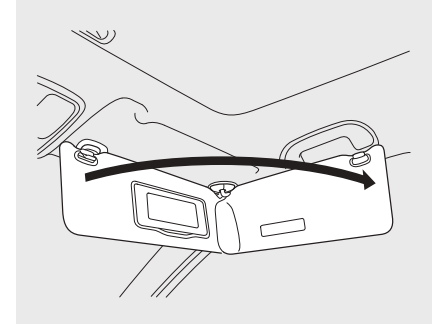

To use the sun visor, pull it down. You can also use the sun visor at the side window. Remove the support rod from the clip and swing the sun visor toward the side window.

Make sure you put the sun visor back in place when you are getting into or out of the vehicle.

Interior Convenience Items

Vanity Mirror

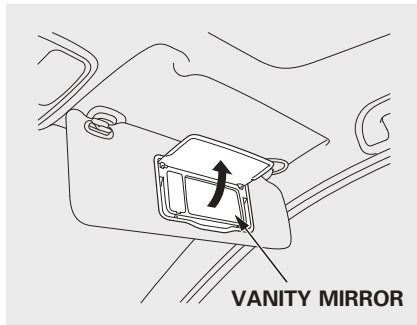

To use the vanity mirror on the back of the sun visor, pull up the cover.

The light comes on when you pull up the cover.

Console Compartment

Your vehicle has a multi-function console compartment. It includes an armrest, a coin holder, a pen holder, a card holder, a removable tray, and a console compartment with two separable shelves.

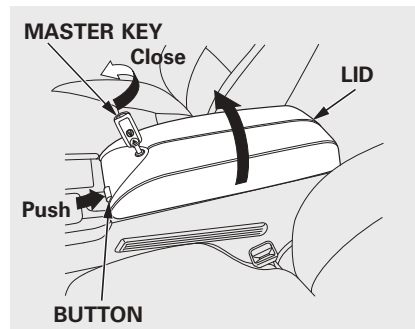

To open the console compartment, push the button and lift the lid.

To close, lower the lid, and push it down until it latches.

You can lock or unlock the console compartment lid with the master key.

Interior Convenience Items

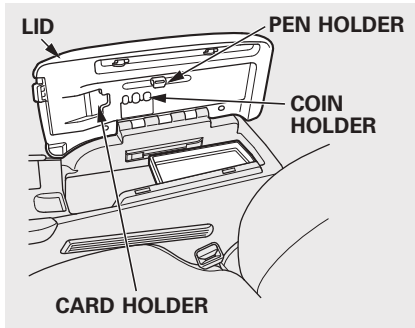

You can use the inside of the lid for a pen holder, a coin holder and a card holder.

The console compartment light comes on when the parking lights are on.

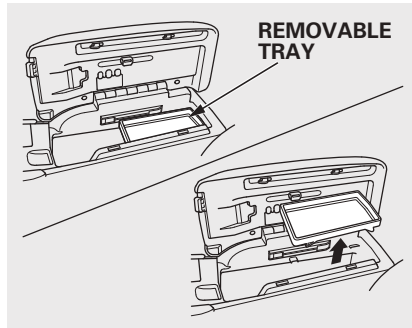

You can store small items on the removable tray.

To remove the tray, pull it out from the console compartment frame to get more space.

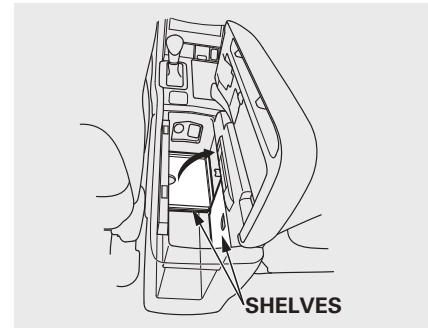

The console compartment has two shelves to divide it into two levels. To store small items, you can use the upper half of the space by putting the shelves down until they latch. The front and rear shelves can be used separately.

The items on each shelves should not exceed 11 lbs (5 kg). Heavy items may damage the shelves.

CONTINUED

Interior Convenience Items

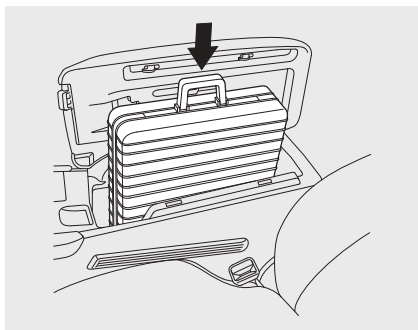

When you store a large item like a briefcase, lift the shelves up to create a large space.

The maximum dimensions of the item you can store in the console compartment are:

Length: 16.9 in (430 mm)

Height: 12.2 in (310 mm)

Width: 5.5 in (140 mm)

Cargo Area Cover



Your vehicle has a cargo area cover to conceal your luggage and protect them from direct sunlight.

Do not put any items on top of the cargo area cover. They can block your view and be thrown around the vehicle during a crash.

The cargo area cover may be removed to give you more cargo space.

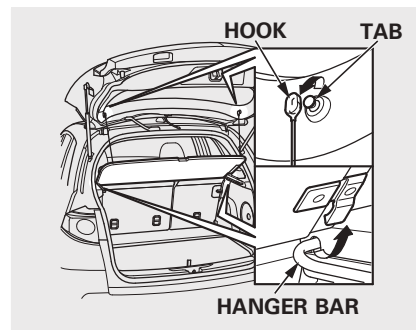

To remove it:

1. Open the tailgate. Remove the hook from the tab on the tailgate. Make sure you use both hands to prevent the cargo area cover from falling accidentally.
2. Lift and pull the rear edge of the cargo area cover slightly to unlock it from the hanger bars, then remove it straight out.



3. Place the cargo area cover on the cargo area floor.

Make sure the cargo area cover is securely placed so it will not move while you are driving.

Reverse this procedure to install the cargo area cover.

[Main Menu](#)

[Table of Contents](#)

The climate control system in your vehicle provides a comfortable driving environment in all weather conditions. The standard audio system has many features. This section describes those features and how to use them. Your vehicle has an anti-theft audio system that requires a code number to enable it. The security system helps to discourage vandalism and theft of your vehicle.

On models with navigation system

The climate control system and the audio system have a voice control feature. Refer to the navigation system manual for more information.

| | |
|---|-----|
| Climate Control System | 164 |
| Dual Temperature Control..... | 169 |
| Climate Control Sensors..... | 171 |
| Audio System..... | 172 |
| Playing the FM/AM Radio (Models without navigation system) | 174 |
| To Play the Radio..... | 174 |
| Adjusting the Sound | 177 |
| Playing the XM® Radio (Models without navigation system) | 179 |
| Playing Discs (Models without navigation system) | 185 |

| | |
|---|-----|
| Disc Changer Error Messages (Models without navigation system) | 195 |
| Playing an iPod (Models without navigation system) | 197 |
| iPod Error Messages (Models without navigation system) | 203 |
| Playing a USB Flash Memory Device (Models without navigation system) | 204 |
| USB Flash Memory Device Error Messages (Models without navigation system) | 211 |
| Bluetooth® Audio System (Models without navigation system) | 212 |
| Audio System (Models with navigation system) | 216 |
| Interface Dial | 216 |
| Playing the FM/AM Radio (Models with navigation system) | 217 |
| Adjusting the Sound | 224 |
| Playing the XM® Radio (Models with navigation system) | 228 |
| Playing Discs (Models with navigation system) | 239 |
| Disc Changer Error Messages (Models with navigation system) | 255 |

| | |
|--|-----|
| Protecting Your Discs..... | 257 |
| Playing an iPod (Models with navigation system) | 260 |
| iPod Error Messages (Models with navigation system) | 269 |
| Playing a USB Flash Memory Device (Models with navigation system) | 270 |
| USB Flash Memory Device Error Messages (Models with navigation system) | 279 |
| Bluetooth® Audio System (Models with navigation system) | 280 |
| FM/AM Radio Reception | 287 |
| Remote Audio Controls..... | 289 |
| Auxiliary Input Jack..... | 291 |
| Radio Theft Protection | 292 |
| Setting the Clock | 293 |
| Security System..... | 294 |
| Compass | 295 |
| Compass Operation | 295 |
| Cruise Control..... | 300 |
| HomeLink® Universal Transceiver | 303 |
| Bluetooth® HandsFreeLink® | 306 |
| AcuraLink® (U.S. models only) | 332 |
| Rearview Mirror with Rearview Camera Display | 348 |

Climate Control System

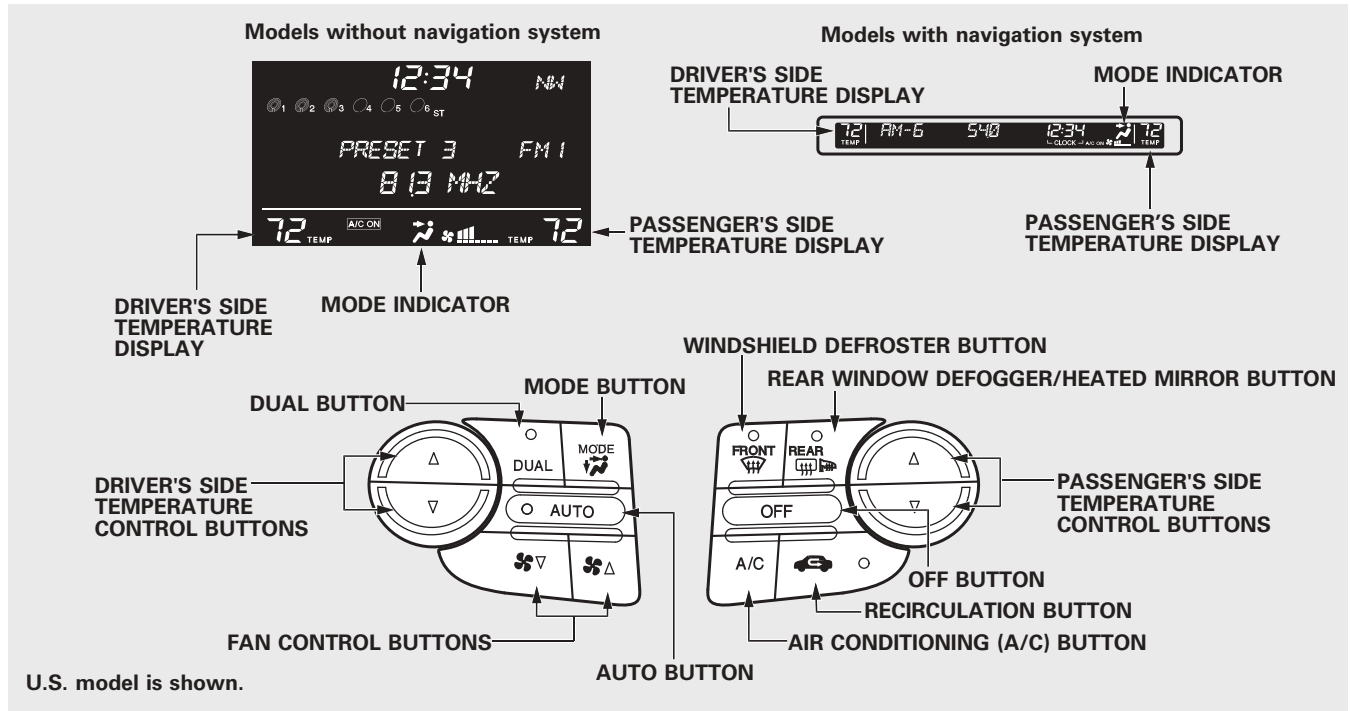

Proper use of the climate control system can make the interior dry and comfortable, and keep the windows clear for best visibility.

For the climate control system to provide heating and cooling, the engine must be running.

You can adjust the temperatures of the driver's side and the passenger's side independently (see page 169).

Voice Control System

On models with navigation system

The climate control system can also be operated by voice control. See the navigation system manual for complete details.

Using Automatic Climate Control

The automatic climate control system adjusts the fan speed and airflow levels to maintain the interior temperature you select.

On models with navigation system

In AUTO mode, the vehicle's interior temperature is independently regulated for the driver and passenger, based on inputs from sunlight and temperature sensors (see page 171). If one side of the vehicle is getting too much sun, the system lowers the temperature only on that side.

1. Press the AUTO button. The indicator in the button comes on.

2. Set the desired temperature by pushing the driver's side temperature control buttons (▲ or ▼). The selected temperature will show in the display.

When you push the passenger's side temperature control buttons, the indicator in the DUAL button comes on and the driver's side and passenger's side temperature can be controlled independently (see page 169).

The system automatically selects the proper mix of conditioned and/or heated air that will, as quickly as possible, raise or lower the interior temperature to your preference.

CONTINUED

Climate Control System

When you set the temperature to its lowest limit (L) or its highest limit (H), the system runs at full cooling or heating only. It does not regulate the interior temperature.

In cold weather, the fan will not come on automatically until the heater starts to develop warm air.

Semi-automatic Operation

You can manually select various functions of the climate control system when it is in the AUTO mode. All other features remain automatically controlled.

Fan Control

Select the fan speed by pressing the fan control buttons (▲ or ▼). The fan speed is represented by vertical bars in the display.

Temperature Control

To adjust the desired temperature, push the temperature control buttons (▲ or ▼).

Dual Button

Press the DUAL button to select dual temperature control mode (see page 169). The indicator in the DUAL button comes on.

When you press the DUAL button again (indicator turns off), both sides adjust to the driver's side temperature.

Air Conditioning (A/C) Button

Press the A/C button to turn the air conditioning on and off. You will see A/C ON or A/C OFF in the display.

When you turn the A/C off, the system cannot regulate the inside temperature if you set the temperature control below the outside temperature.

Recirculation Button 

When the indicator in the button is on, air from the vehicle's interior is sent through the system again. When the indicator is off, air is brought in from the outside of the vehicle (fresh air mode).

The outside air intakes for the climate control system are at the base of the windshield. Keep this area clear of leaves and other debris.

The system should be left in fresh air mode under almost all conditions. Keeping the system in recirculation mode, particularly with the A/C off, can cause the windows to fog up.

Switch to recirculation mode when driving through dusty or smoky conditions, then return to fresh air mode.

Windshield Defroster Button 

This button turns the windshield defrost on and off.

When you push this button, air flows from the defroster vents at the base of the windshield, and the system automatically switches to fresh air mode and turns on the A/C. When the indicator in the button is on, the passenger's temperature cannot be set separately from the driver's.

Rear Window Defogger Button

This button turns the rear window defogger on and off. Pushing this button also turns the mirror heaters on and off (see page [121](#)).

CONTINUED

Climate Control System

Mode Button

Use the MODE button to select the vents the air flows from. Some air will flow from the dashboard corner vents in all modes.

The mode indicator in the display changes to the current mode each time you press the button.

 Air flows from the center and corner vents in the dashboard.

 Airflow is divided between the vents in the dashboard and the floor vents.

 Air flows from the floor vents.

 Airflow is divided between the floor vents and the defroster vents at the base of the windshield.

To Turn Everything Off

If you press the OFF button, the climate control system shuts off completely.

- Keep the system off for short periods only.
- To keep stale air and mustiness from collecting, you should have the fan running at all times.

When the climate control system is turned off, the temperature in the display will also turn off.

Climate Control System

Dual Temperature Control

Your vehicle has four temperature control buttons, two for the driver, and two for the front passenger.

The driver's side and the passenger's side can be controlled independently by adjusting these buttons when the indicator in the DUAL button is lit.

Temperature Control Buttons

To set the driver's side temperature to a different value than the passenger's, press the DUAL button, then press the temperature control buttons (▲ or ▼) on the driver's side. To set the passenger's side to a different value than the driver's, press the temperature control buttons (▲ or ▼) on the passenger's side. You can adjust the passenger's side without pressing the DUAL button first.

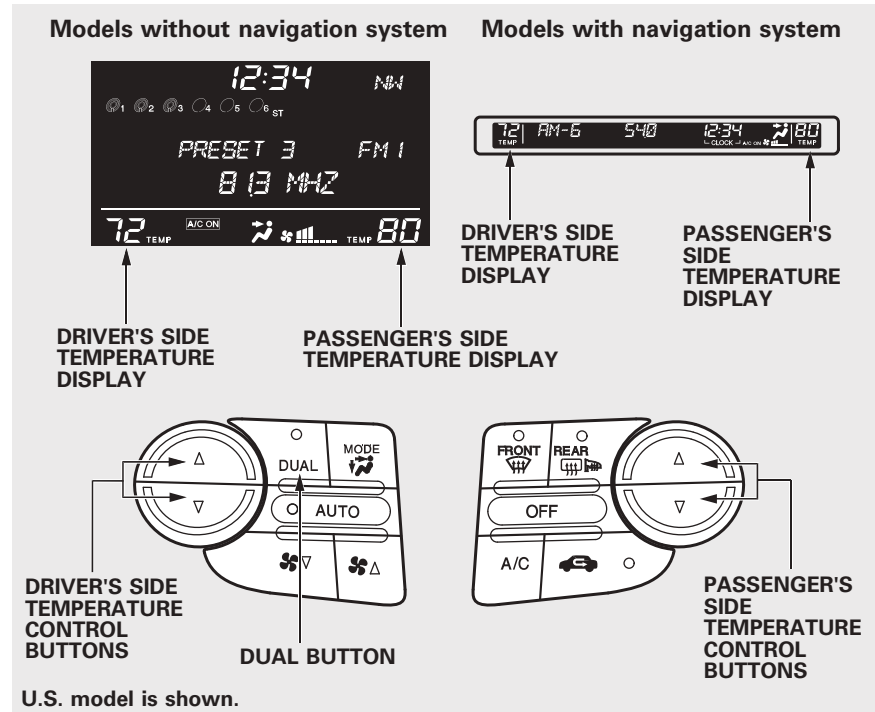

CONTINUED

Climate Control System

When you set the temperature to its lower or upper limit, it is displayed as **Lo** or **Hi**.

Push **AUTO** or . The selected temperatures appear in the display. When the indicator in the **DUAL** button is off, you can adjust both sides to the same temperature by adjusting the driver's side temperature control buttons (**▲** or **▼**).

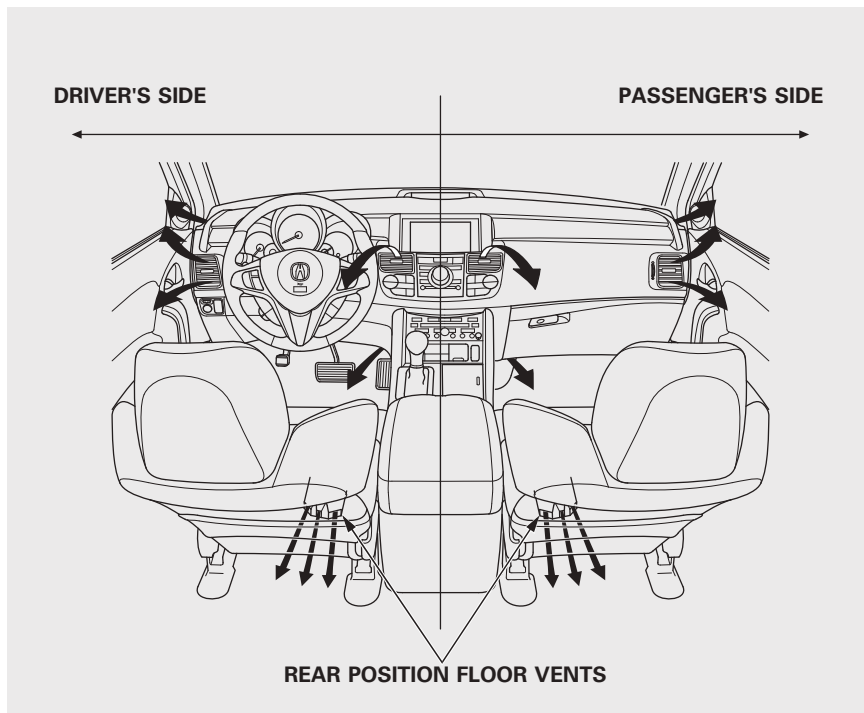

Climate Control Sensors

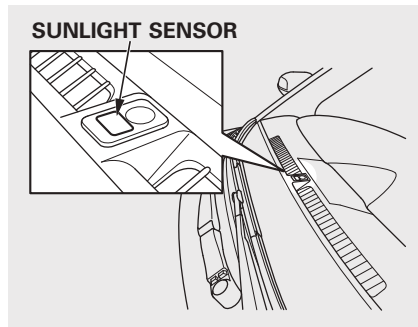

The climate control system has two sensors. A sunlight sensor is in the top of the dashboard, and a temperature sensor is next to the steering column. Do not cover the sensors or spill any liquid on them.

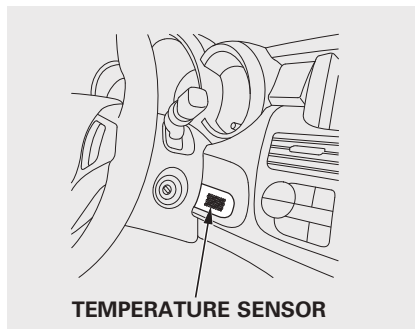

Audio System

Read the appropriate pages in this section for operation of the audio systems installed in your vehicle.

- For vehicles without navigation system, see pages [174](#) thru [215](#).
- For vehicles with navigation system, see page [216](#) thru [286](#).

Models without navigation system

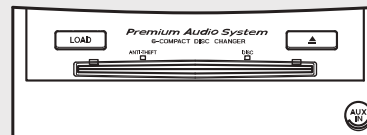
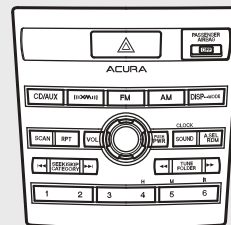

U.S. model is shown.

Models with navigation system

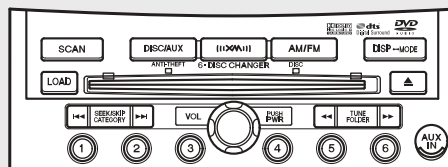
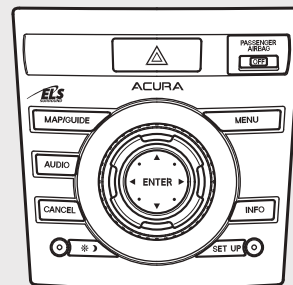
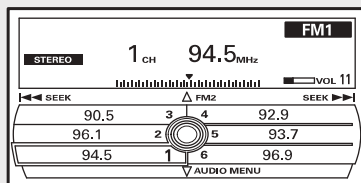

U.S. model is shown.

Playing the FM/AM Radio (Models without navigation system)

To Play the Radio

The ignition switch must be in the ACCESSORY (I) or the ON (II) position. Turn the system on by pushing the PWR/VOL knob, or the AM or FM button. Adjust the volume by turning the PWR/VOL knob.

The band and frequency that the radio was last tuned to is displayed. To change bands, press the AM or FM button. On the FM band, "ST" will be shown on the center display if the station is broadcasting in stereo. Stereo reproduction on AM is not available.

XM Radio information is available on page 179.

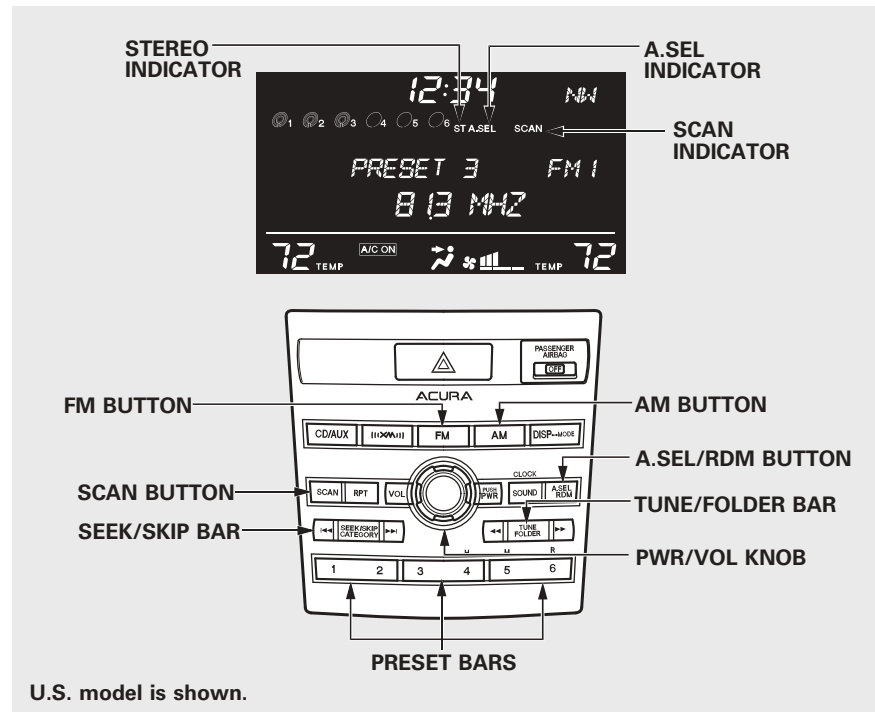

Playing the FM/AM Radio (Models without navigation system)

To Select a Station

You can use any of five methods to find radio stations on the selected band: tune, seek, scan, the preset bars, and auto select.

TUNE – Use the TUNE/FOLDER bar to tune the radio to a desired frequency. Press the ►► side of the bar to tune to a higher frequency, and the ◄◄ side of the bar to tune to a lower frequency.

If you press and hold the ◄◄ or ►► side of the bar, the frequency will begin to change rapidly. It will stop when you release it.

SEEK – The SEEK function searches up and down from the current frequency to find a station with a strong signal. To activate it, press the ◄◄ or ►► side of the SEEK/SKIP bar, then release it.

SCAN – The SCAN function samples all stations with strong signals on the selected band. To activate it, press the SCAN button, then release it. You will see “SCAN” on the center display. When it finds a strong signal, it will stop and play that station for about 10 seconds.

If you do nothing, the system will then scan for the next strong station and play it for 10 seconds. When it plays a station you want to listen to, press the SCAN button again.

Preset – Each side of the bars (1 – 6) can store one frequency on AM and two frequencies on FM.

1. Select the desired band, AM or FM. FM1 and FM2 let you store two frequencies with each side of the preset bar.
2. Use the TUNE, SEEK, or SCAN function to tune the radio to a desired station.
3. Pick the preset number (1 – 6), for the station you want to store. Press the left or right side of the bar, and hold it until you hear a beep.
4. Repeat steps 1 through 3 to store a total of six stations on AM and twelve stations on FM.

CONTINUED

Playing the FM/AM Radio (Models without navigation system)

AUTO SELECT – If you are traveling and can no longer receive your preset stations, you can use the auto select feature to find stations in the local area.

To activate it, press the A.SEL/RDM button. “A.SEL” will flash on the center display, and the system will go into scan mode for several seconds. It stores the frequencies of six AM and twelve FM stations in the preset bars (1 – 6).

You will see “0” displayed if auto select cannot find a strong station for every preset bar.

If you do not like the stations auto select has stored, you can store other frequencies on the preset bars.

To turn off auto select, press the A.SEL/RDM button. This restores the presets you originally set.

Radio Frequencies and Reception

For information on AM/FM radio frequencies and reception, see page [287](#).

Adjusting the Sound

For information, see page [177](#).

Playing the FM/AM Radio (Models without navigation system)

Adjusting the Sound

Press the SOUND/CLOCK button repeatedly to display the BASS, TREBLE, FADER, BALANCE, SUBWOOFER and SVC (speed-sensitive volume compensation) settings.

Each mode is shown on the center display as it changes. Turn the PWR/VOL knob to adjust the setting to your liking. When the level reaches the center, you will see “L” on the center display. The system will automatically return the display to the selected audio mode about 10 seconds after you stop adjusting a mode.

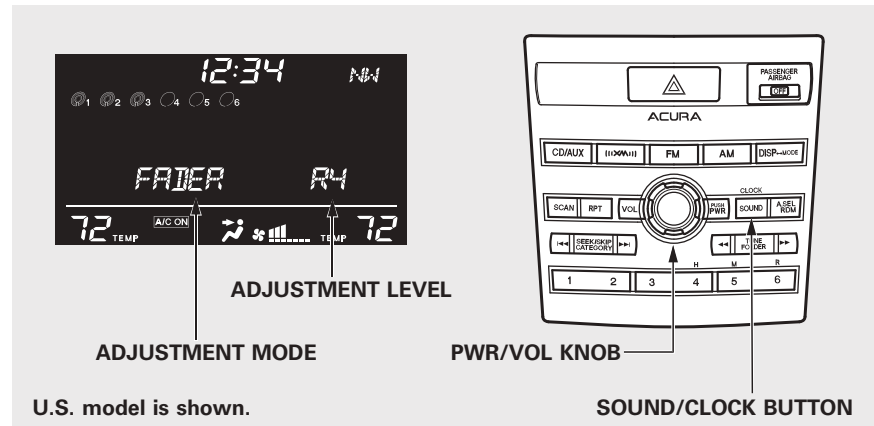

Treble/Bass – Use the TREBLE/BASS modes to adjust the tone to your liking. You can adjust each mode in levels between -6 and $+6$.

Balance/Fader – These two modes adjust the strength of the sound coming from each speaker. BALANCE adjusts the side-to-side strength, while FADER adjusts the front-to-back strength.

BALANCE can be adjusted in levels between L9 and R9. FADER can be adjusted in levels between F9 and R9. When FADER adjustment level reaches F9, the subwoofer speaker will be turned off.

CONTINUED

Playing the FM/AM Radio (Models without navigation system)

SUBWOOFER – Use the SUBWOOFER mode to adjust the strength of the sound from the subwoofer speaker. Turn the PWR/VOL knob to the desired level (– 6 to + 6). Even if the adjustment level reaches – 6, the subwoofer is not turned off.

Speed-sensitive volume compensation (SVC) – The SVC mode controls the volume based on vehicle speed. The faster you go, the louder the audio volume becomes. As you slow down, the audio volume decreases.

The SVC has four modes: SVC OFF, SVC LOW, SVC MID, and SVC HIGH. The default setting is MID. Turn the PWR/VOL knob to adjust the setting to your liking.

Audio System Lighting

You can use the instrument panel brightness control knob to adjust the illumination of the audio system (see page [120](#)). The audio system illuminates when the parking lights are on, even if the system is turned off.

Playing the XM® Radio (Models without navigation system)

Your vehicle is capable of receiving XM® Radio anywhere in the United States and Canada, except Hawaii, Alaska, and Puerto Rico. XM is a registered trademark of Sirius XM Radio Inc. and XM CANADA® is a registered business name of Canadian Satellite Radio Inc.

XM Radio receives signals from two satellites to produce clear, high-quality digital reception. It offers many channels in several categories. Along with a large selection of different types of music, XM Radio also allows you to view channel and category selections in the audio display.

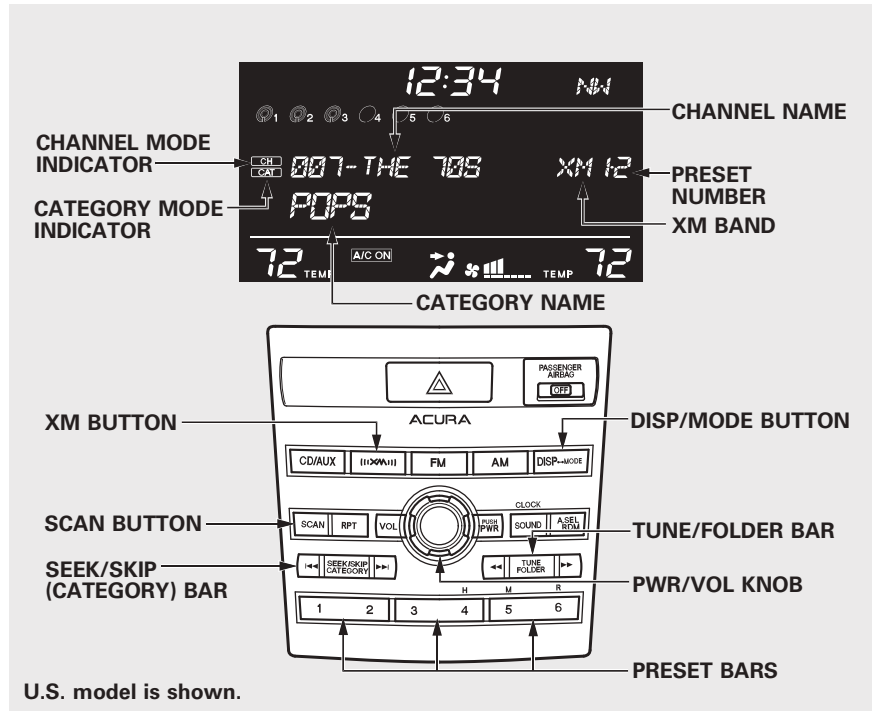

CONTINUED

Playing the XM® Radio (Models without navigation system)

Operating the XM Radio



To listen to the XM Radio, turn the ignition switch to the ACCESSORY (I) or ON (II) position. Push the PWR/VOL knob to turn on the audio system, and press the «» button. Adjust the volume by turning the PWR/VOL knob. The last channel you listened to will show on the audio display.



DISP – Each time you press and release the DISP/MODE button, the center display changes in the following sequence: Channel name, category, artist name, and music title.

MODE – To switch between the category mode and channel mode, press and hold the DISP/MODE button until the mode changes. A “CH” (channel) or “CAT” (category) mode indicator appears on the center display.

To Select a Channel

When in the satellite radio mode, you can use any of four methods to find channels: TUNE, SEEK/SKIP (CATEGORY), SCAN, and the preset bars.

TUNE – Press the TUNE/FOLDER bar to change channel selections. Press the  side of the bar to tune to higher numbered channels, and the  side of the bar to tune to lower numbered channels. In the category mode, you can only select channels within that category.

SEEK/SKIP (CATEGORY) – Press either side of the SEEK/SKIP (CATEGORY) bar ( or ) to select another category.

Playing the XM® Radio (Models without navigation system)

SCAN – The scan function gives you a sampling of all channels while in the channel mode. In the category mode, only the channels within that category are scanned. To activate scan, press the SCAN button. The system plays each channel in numerical order for a few seconds, then selects the next channel. When you hear a channel you want to continue listening to, press the button again.

Preset – You can store up to 12 preset channels using each side of the preset bar. Each side of the bar stores one channel from the XM1 band and one channel from the XM2 band.

To store a channel:

1. Press the «XM» button. Either XM1 or XM2 will be shown on the center display.
2. Use the tune, seek, or scan function to tune to a desired channel.

In category mode, only channels within that category can be selected. In channel mode, all channels can be selected.

3. Pick a preset number for the channel you want to store. Press and hold the appropriate side of the preset bar until you hear a beep.
4. Repeat steps 2 and 3 to store the first six channels.
5. Press the «XM» button again. The other XM band will be shown. Store the next six channels by repeating steps 2 and 3.

Once a channel is stored, press and release the proper side of the preset bar to tune to it.

Adjusting the Sound

For information, see page [177](#).

XM Radio Reception

For information, see page [183](#).

CONTINUED

Playing the XM® Radio (Models without navigation system)

XM Radio Display Messages

“LOADING” — XM is loading the audio or program information.

“OFF AIR” — The channel currently selected is no longer broadcasting.

“UPDATING” — The encryption code is being updated. Wait until the encryption code is fully updated. Channels 0 and 1 should still work normally.

“NO SIGNAL” — The signal is currently too weak. Move the vehicle to an area away from tall buildings, and with an unobstructed view of the southern horizon.

“ - - - - ” — The selected channel number does not exist, or is not part of your subscription, or this channel has no artist or title information at this time.

“ANTENNA” — There is a problem with the XM antenna. Please consult your dealer.

Playing the XM® Radio (Models without navigation system)

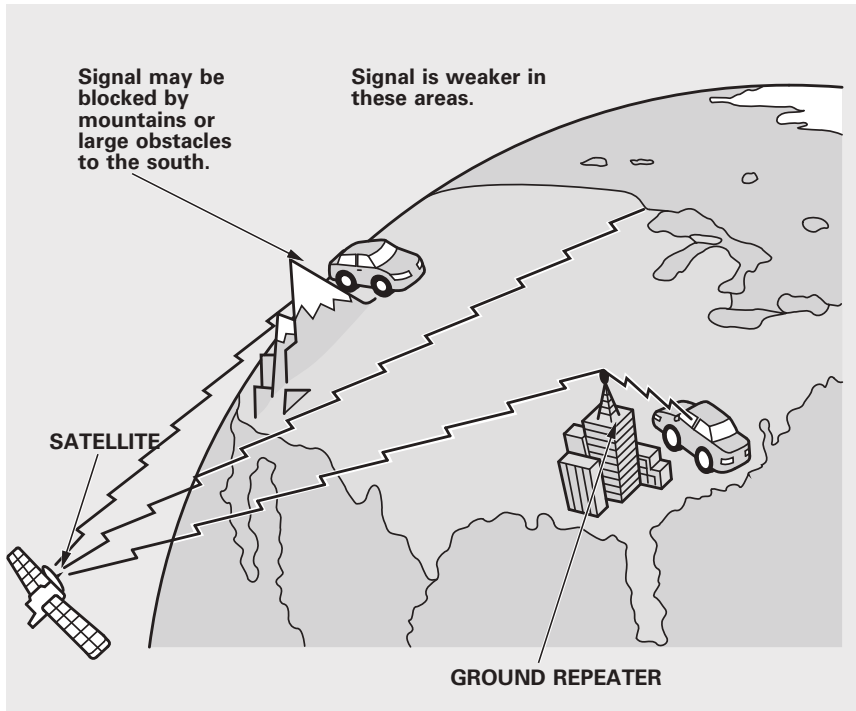

Satellite Radio Signals

Satellite radio receives signals from two satellites to produce clear, high-quality digital reception. It offers many channels in several categories. Along with a large selection of different types of music, satellite radio also allows you to view channel and category selections in the audio display.

The XM satellites are in orbit over the equator; therefore, objects south of the vehicle may cause satellite reception interruptions. To help compensate for this, ground-based repeaters are placed in major metropolitan areas.

Satellite signals are more likely to be blocked by tall buildings and mountains the farther north you travel from the equator.

CONTINUED

Playing the XM® Radio (Models without navigation system)

Depending on where you drive, you may experience reception problems. Interference can be caused by any of these conditions:

- Driving on the north side of an east/west mountain road.
- Driving on the north side of a large commercial truck on an east/west road.
- Driving in tunnels.
- Driving on a road beside a vertical wall, steep cliff, or hill to the south of you.
- Driving on the lower level of a multi-tiered road.
- Driving on a single lane road alongside dense trees taller than 50 ft. (15 m) to the south of you.

There may also be other geographic situations or structures that could affect satellite radio reception.

*As required by the FCC:
Changes or modifications not expressly approved by the party responsible for compliance could void the user's authority to operate the equipment.*

Receiving XM Radio Service

If your XM Radio service has expired or you purchased your vehicle from a previous owner, you can listen to a sampling of the broadcasts available on XM radio. With the ignition switch in the ACCESSORY (I) or the ON (II) position, push the PWR/VOL knob to turn on the audio system, and press the «XM» button. A variety of music types and styles will play.

If you decide to purchase XM Radio service, contact XM Radio at www.xmradio.com, or at 1-800-852-9696. In Canada, contact XM CANADA at www.xmradio.ca, or at 1-877-209-0079. You will need to give them your radio I.D. number and your credit card number. To get your radio I.D. number, turn the TUNE knob until "0" appears in the display. Your I.D. will appear in the display.

After you've registered with XM Radio, keep your audio system in the satellite radio mode while you wait for activation. This should take about 30 minutes.

While waiting for activation, make sure your vehicle remains in an open area with good reception. Once your audio system is activated, "CAT" or "CH" will appear in the display, and you'll be able to listen to XM Radio broadcasts. XM Radio will continue to send an activation signal to your vehicle for at least 12 hours from the activation request. If the service has not been activated after 36 hours, contact XM Radio. In Canada, contact XM CANADA®.

Playing Discs (Models without navigation system)

Normal mode

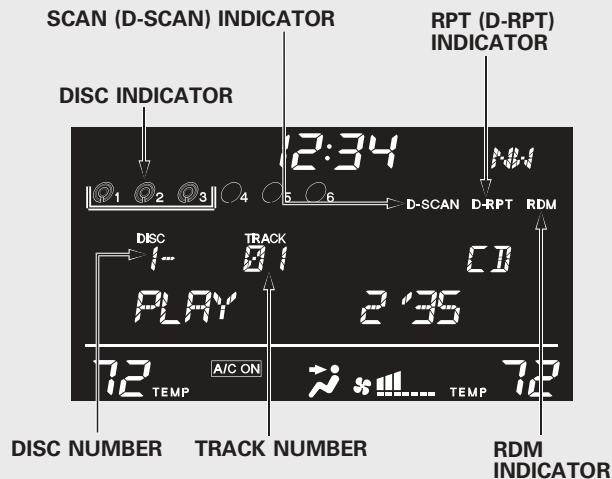

MP3/WMA mode

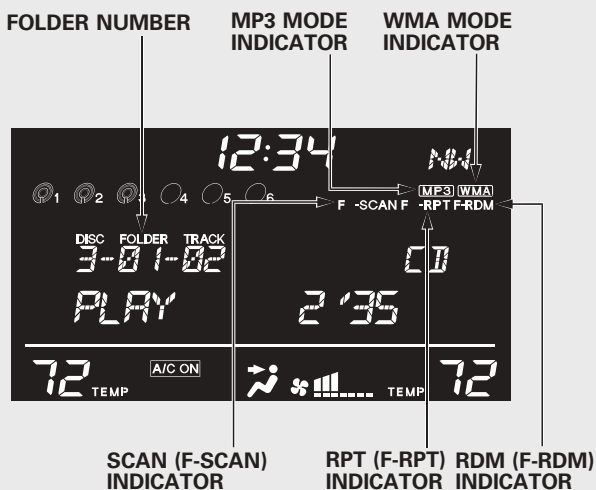

U.S. model is shown.

CONTINUED

Playing Discs (Models without navigation system)

U.S. model is shown.

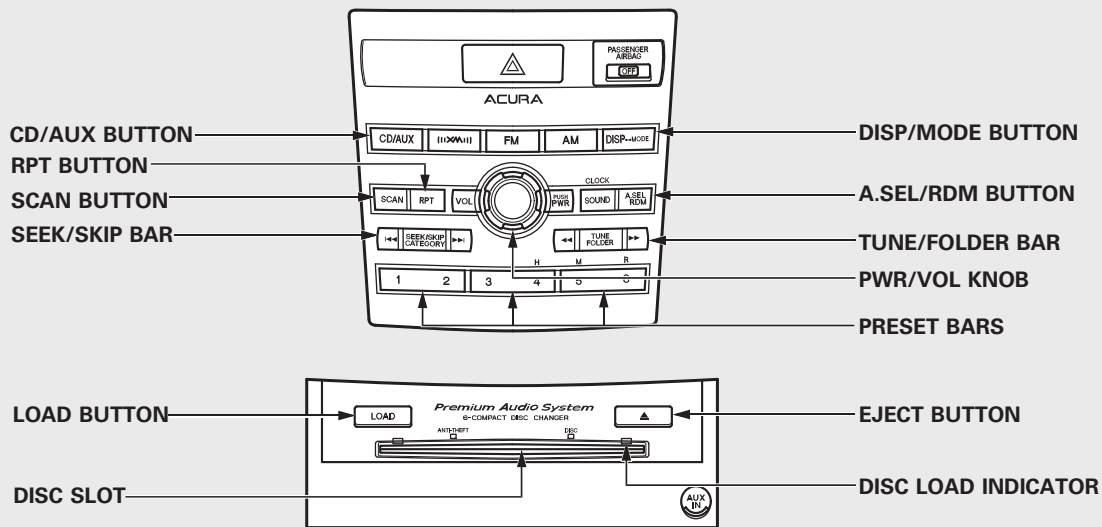

Playing Discs (Models without navigation system)

Your audio system has an in-dash CD changer that holds up to six CDs, providing several hours of continuous entertainment. You operate this CD changer with the same controls used for the radio.

To load CDs or operate the CD changer, the ignition switch must be in the ACCESSORY (I) or ON (II) position.

The disc changer can play these disc formats:

- CD (CD-DA)
- CD-R/RW

The disc packages or jackets should have one of these marks.

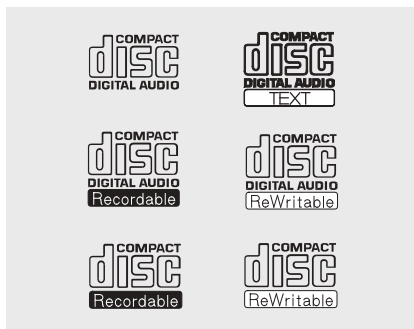

The changer can also play MP3 or WMA format (see page [189](#)).

For best results when using CD-R or CD-RW discs, use only high quality discs labeled for audio use. When recording a CD-R or CD-RW, the recording must be closed in order for the disc to be played by the CD player.

NOTICE

Do not use CDs with adhesive labels. The label can curl up and cause the CD to jam in the unit.

You cannot load and play 3-inch (8-cm) discs in this system. Video CDs and DVDs will not work in this unit.

CONTINUED

Playing Discs (Models without navigation system)

Loading CDs in the Changer

To load multiple discs in one operation:

1. Press and hold the LOAD button on the changer unit until you hear a beep. You will see “BUSY” on the center display, and disc load indicator turns red and starts blinking.
2. Insert the disc into the disc slot when the disc load indicator turns green and “LOAD” appears on the center display at the same time. Insert it only halfway; the drive will pull it in the rest of the way. You will see “BUSY” on the center display, and the disc load indicator turns red again and blinks as the CD is loaded.

3. When the disc load indicator turns green and “LOAD” appears on the center display again, insert the next CD in the slot.

Do not try to insert a disc until “LOAD” appears. You could damage the audio unit.

4. Repeat steps 1 through 3 until all six positions are loaded. If you are not loading all six positions, press the LOAD button again after the last CD has loaded. “DISC READ” appears on the center display, then the system begins playing the last CD loaded.

If you stop loading discs before all six positions are filled, the system will wait for 10 seconds, stop the load operation, and begin playing the last disc loaded.

To load a single disc:

1. Press and release the LOAD button on the changer unit. You will see “BUSY” on the center display, and the disc load indicator turns red and starts blinking.
2. Insert a disc into the disc slot when the disc load indicator turns green and “LOAD” appears on the center display at the same time. Insert the disc only about halfway; the drive will pull it in the rest of the way. You will see the disc indicator blinking on the center display.

Do not try to insert a disc until “LOAD” appears. You could damage the audio unit.

Playing Discs (Models without navigation system)

3. You will see “DISC READ” on the center display, then the system begins to play the CD.

You can load a CD into an empty position while a CD is playing. Select the empty position (the disc indicator is not shown on the center display) by pressing the appropriate side of the preset bars. The current CD stops playing and starts the loading sequence. The CD just loaded will play.

You can load a disc(s) in any mode (AM, FM, XM, or AUX) if you do not select an empty position.

If you press the LOAD button while a disc is playing, the system will stop playing that disc and start the loading sequence. It will then play the disc just loaded.

To Play a CD

Select the CD changer by pressing the CD/AUX button. You will see “CD” on the center display. The system will begin playing the last selected CD in the CD changer. You will see the disc and track numbers displayed.

When the system reaches the end of the disc, the system will advance to the next disc and begin to play. To select a different disc, press an appropriate side of the preset bar (1 – 6). If you select an empty position in the CD changer, the system will try to load the CD in the empty slot.

Playing an MP3/WMA Disc

The CD changer can play CD-Rs and CD-RWs compressed in MP3 and WMA format. When playing a disc in MP3 or WMA, you will see “MP3” or “WMA” on the center display. A disc can support more than 99 folders, and each folder can hold up to 255 playable files.

When there are more than 99 folders on a disc, the center display only shows two digits.

NOTE: If a file on an MP3 or WMA disc is protected by digital rights management (DRM), the audio unit displays FORMAT, and then skips to the next file.

If the disc has a complex structure, it will take a while to read the disc before the system begins to play it.

CONTINUED

Playing Discs (Models without navigation system)

The specifications for compatible MP3 files are:

- Sampling frequency:
32/44.1/48 kHz (MPEG1)
24/22.05/16 kHz (MPEG2)
- Bitrate:
32/40/48/56/64/80/96/112/128/
160/192/224/256/320 kbps
(MPEG1)
8/16/24/32/40/48/56/64/80/96/
112/128/160 kbps (MPEG2)
- Compatible with variable bitrate
and multi-session
- Maximum layers
(including ROOT): 8 layers

The specifications for compatible WMA files are:

- Sampling frequency:
32/44.1/48 kHz
- Bitrate:
48/64/80/96/128/160/192 kbps

- Compatible with variable bitrate
and multi-session
- Maximum layers
(including ROOT): 8 layers

Name Display Function

Each time you press the DISP/MODE button while playing a CD (CD-DA), the center display changes from album name, to track name, to artist name, and then to normal display. If the disc was not recorded with CD-TEXT, "NO INFO" will be shown on the center display.

When playing a disc compressed in MP3/WMA format, the display changes from folder name, to file name, to artist tag, to album tag, to track tag, and then to normal display each time you press the DISP/MODE button. If the disc was not recorded with this information, "NO INFO" will be shown on the center display.

If the title is too long, it will not show all at once. Press and hold the DISP/MODE button, and the rest of the title will show on the center display.

You will also see the album and track name (CD-TEXT), or the folder and file name (MP3/WMA) under these conditions:

- When you insert a disc, and the system begins to play.
- Each time a new track, file, or folder plays.

Playing Discs (Models without navigation system)

To Change or Select Tracks/Files

While a disc is playing you can use the SEEK/SKIP bar to select passages and change tracks (files in MP3/WMA mode).

In MP3/WMA mode, use the TUNE/FOLDER bar to select folders on the disc, and use the SEEK/SKIP bar to change files.

SEEK/SKIP – Each time you press and release the ►►| side of the SEEK/SKIP bar, the system skips forward to the beginning of the next track (file in MP3/WMA mode). Press and release the |◄◄ side of the bar to skip backward to the beginning of the current track/file. Press it again to skip to the beginning of the previous track/file.

To move rapidly within a track/file, press and hold the ►►| or |◄◄ side of the SEEK/SKIP bar.

In MP3/WMA mode

FOLDER SELECTION – To select a different folder, press and release the ►► side of the TUNE/FOLDER bar to move to the beginning of the next folder. Press and release the ◄◄ side of the bar to move to the beginning of the previous folder.

REPEAT – This feature, when activated, continuously replays the current track (file in MP3/WMA mode). To activate it, press and release the RPT button. You will see “RPT” on the center display. To turn off this feature, press the RPT button for more than 2 seconds.

CONTINUED

Playing Discs (Models without navigation system)

In MP3/WMA mode

FOLDER REPEAT – This feature, when activated, replays all the files in the current folder in the order they are compressed in MP3/WMA. To activate folder repeat mode, press the RPT button twice. You will see “F-RPT” on the center display. Press and hold the RPT button for more than 2 seconds to turn off this feature.

DISC REPEAT – Press the RPT button twice to continuously replay the current CD. In MP3/WMA mode, press the RPT button three times. You will see “D-RPT” on the center display. Press and hold the RPT button for more than 2 seconds to turn off this feature.

Each time you press and release the RPT button, the mode changes from repeat to folder repeat, disc repeat then to normal play.

SCAN – The scan function samples all the tracks (files in a folder in MP3/WMA mode) on the current disc in the order they are recorded on the CD. To activate this feature, press and release the SCAN button. You will see “SCAN” and the track/file number flashing on the center display. The system will then play the track/file for approximately 10 seconds. To hear the rest of the track/file, press and hold the SCAN button for more than 2 seconds. If you do nothing, the system will then play the following tracks/files for 10 seconds each. When the system finishes scanning all the tracks/files on the current disc, the system returns to the track/file it first started scanning with, scan is canceled and the system begins to play that track/file normally.

In MP3/WMA mode

FOLDER SCAN – The folder scan function samples the first file of each folder on the current disc in the order they are compressed in MP3/WMA. To activate this feature, press the SCAN button twice. The first file of each folder plays for about 10 seconds. You will see “F-SCAN” and the folder number flashing on the center display. To hear the rest of the file in the folder currently scanning, press and hold the SCAN button for more than 2 seconds. When the system finishes scanning all the folders on the current disc, the system returns to the folder it started scanning with, folder scan is canceled and the system begins to play that folder normally.

Playing Discs (Models without navigation system)

DISC SCAN – The disc scan function samples the first track (file in MP3/WMA mode) on each disc within the changer in numerical order. To activate this feature, press the SCAN button twice. In MP3/WMA mode, press the SCAN button three times. The first track/file on each disc plays for about 10 seconds. You will see “D-SCAN” and disc number flashing on the center display. To hear the rest of the track/file on the disc currently scanning, press and hold the SCAN button for more than 2 seconds. When the system finishes scanning all the discs, disc scan is canceled and the system begins to play the first track/file of that disc normally.

Each time you press and release the SCAN button, the mode changes from scan to folder scan, disc scan then to normal play.

RANDOM (Random within a Disc) – This feature plays the tracks (all files in each folder in MP3/WMA mode) within a disc in random order. To activate it, press and release the A.SEL/RDM button. In MP3/WMA mode, press the A.SEL/RDM button twice to select random play within a disc. You will see “RDM” on the center display. Press and hold the A.SEL/RDM button for more than 2 seconds to return to normal play.

In MP3/WMA mode

FOLDER RANDOM – This feature plays the files within a folder in random order, rather than in the order they are compressed in MP3/WMA. To activate it, press the A.SEL/RDM button once. You will see “F-RDM” on the center display. The system will then select and play files randomly. This continues until you deactivate folder random play by pressing and holding the RDM button for more than 2 seconds.

Each time you press and release the A.SEL/RDM button, the mode changes from folder random to random, then to normal play.

CONTINUED

Playing Discs (Models without navigation system)

To Pause a Disc

To pause a disc, press the corresponding number of the current disc on the appropriate side of the preset bars. To play the disc again, press the preset bar again.

To Stop Playing a Disc

If you turn the system off while a CD is playing, either with the PWR/VOL knob or by turning off the ignition switch, the disc will stay in the drive. When you turn the system back on, the CD will begin playing where it left off.

To take the system out of CD mode, press the AM or FM, CD/AUX, or («») button. To return to CD mode, press the CD/AUX button. The system will continue at the same point that it left off.

Removing CDs from the Changer

To remove the disc that is currently playing, press and release the eject () button. You will see “EJECT” on the center display. When you remove the disc from the slot, the system begins the load sequence so you can load another disc in that position. If you do not load another CD within 10 seconds, the system selects the previous mode (AM, FM1, FM2, or XM).

If you do not remove the CD from the slot, the system will reload the CD after 10 seconds and put the CD changer in pause mode. To begin playing the CD, press the CD/AUX button.

To remove a different CD from the changer, select it with the appropriate side of the preset bar. When that CD begins playing, press the eject button.

Press and hold the eject button until you hear a beep to remove all the discs from the changer.

You can also eject discs when the ignition switch is off by pressing the eject button. The disc that was last selected is ejected first. You can eject the rest of the discs one at a time.

Protecting Discs

For information on how to handle and protect compact discs, see page [257](#).

Disc Changer Error Messages

For information, see page [195](#).

Adjusting the Sound

For information, see page [177](#).

Disc Changer Error Messages (Models without navigation system)

If you see an error message in the display while playing a CD, find the cause in the chart to the right. If you cannot clear the error message, take the vehicle to your dealer.

| Error Message | Cause | Solution |
|------------------------|------------------------------|--|
| <i>CHECK DISC</i> | FOCUS Error | Press the EJECT button, and pull out the disc. Check if it is inserted correctly in the disc changer. Make sure the disc is not scratched or damaged. For more information, see page 258. |
| <i>MECH ERROR</i> | Mechanical Error | Press the EJECT button, and pull out the disc. Check the disc for damage or deformation. For more information, see page 258. If the disc cannot be pulled out, or the error message does not disappear after the disc is ejected, see your dealer. |
| <i>HOT</i> | High Temperature | Will disappear when the temperature returns to normal. |
| <i>CHECK DISC LOAD</i> | Check Disc | Press the EJECT button, and pull out the disc. Make sure a playable disc is in the CD changer (see page 187). |
| <i>CHANGER ERROR</i> | Check Disc and Changer Error | Press the EJECT button, and pull out the disc. Check the disc for damage or deformation. For more information, see page 258. If the disc cannot be pulled out, or the error message does not disappear after the disc is ejected, see your dealer. |

CONTINUED

Disc Changer Error Messages (Models without navigation system)

The chart on the right explains the error messages you may see in the display while playing a disc.

If you see an error message in the display while playing a disc, press the eject button. After ejecting the disc, check it for damage or deformation. If there is no damage, insert the disc again.

For the additional information on damaged discs, see page [258](#).

The audio system will try to play the disc. If there is still a problem, the error message will reappear. Press the eject button, and pull out the disc.

Insert a different disc. If the new disc plays, there is a problem with the first disc. If the error message cycle repeats and you cannot clear it, take your vehicle to a dealer.

| Error Message | Cause | Solution |
|---|---------------------------------|--|
| FORMAT | Track/File format not supported | Current track will be skipped. The next supported track or file plays automatically. |
| BAD DISC PLEASE CHECK OWNER'S MANUAL PUSH EJECT | Mechanical error | Press the EJECT button, and pull out the disc(s). Check the disc for serious damage, signs of deformation, excessive scratches, and/or dirt (see page 258 .) |
| BAD DISC PLEASE CHECK OWNER'S MANUAL | Servo error | Insert the disc again. If the code does not disappear, or the disc(s) cannot be removed, consult your dealer. Do not try to force the disc out of the player. |

Playing an iPod (Models without navigation system)

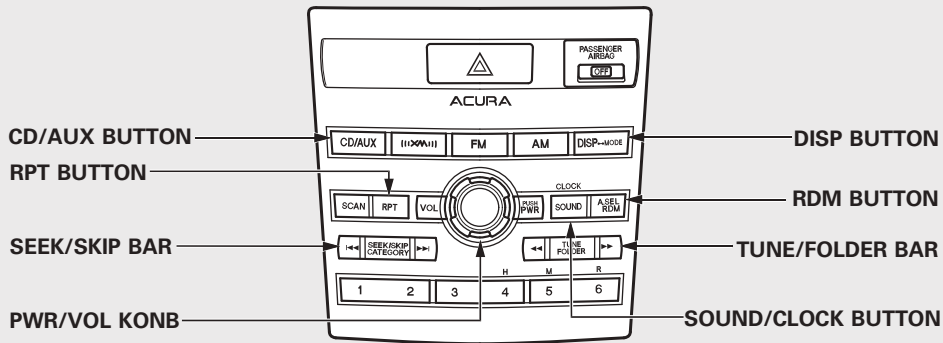
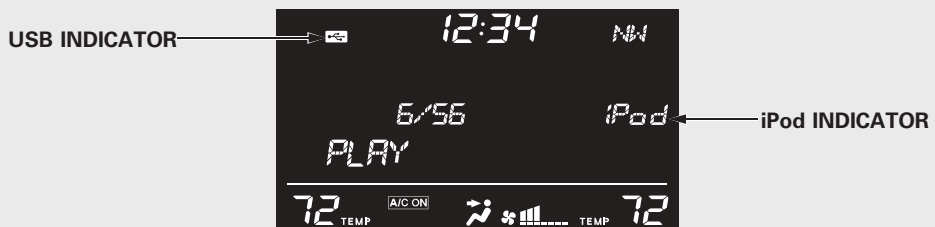

U.S. model is shown.

CONTINUED

Features

Playing an iPod (Models without navigation system)

To Play an iPod®

This audio system can operate the audio files on the iPod® with the same controls used for the disc player. To play an iPod, connect it to the USB adapter cable in the console compartment by using your dock connector, then press the CD/AUX button. The ignition switch must be in the ACCESSORY (I) or ON (II) position. The iPod will also be charged with the ignition switch in these positions.

The audio system reads and plays sound files to be playable on the iPod. The system cannot operate an iPod as a mass storage device. The system will only play songs stored on the iPod with iTunes.

iPod and iTunes are registered trademarks owned by Apple Inc.

iPods compatible with your audio system using the USB adapter cable are:

| Model | Software |
|---------------------------------------|--------------------|
| iPod classic | Ver. 1.0 or more |
| iPod with video (iPod 5th generation) | Ver. 1.2 or more |
| iPod nano | Ver. 1.2 or more |
| iPod nano 2nd generation | Ver. 1.1.2 or more |
| iPod nano 3rd generation | Ver. 1.0 or more |
| iPod nano 4th generation | Ver. 1.0.2 or more |
| iPod touch | Ver. 1.1.1 or more |
| iPod touch 2nd generation | Ver. 2.1.1 or more |

Use only compatible iPods with the latest software. iPods that are not compatible will not work in this audio unit.

NOTE:

- Do not connect your iPod using a hub.
- Do not keep the iPod in the vehicle. Direct sunlight and high heat will damage it.
- Do not use an extension cable between the USB adapter cable equipped with your vehicle and your dock connector.
- We recommend backing up your data before playing it.
- Some devices cannot be powered or charged via the USB adapter, if this is the case use the accessory adapter to supply power to your device.

Playing an iPod (Models without navigation system)

Connecting an iPod

USB ADAPTER CABLE

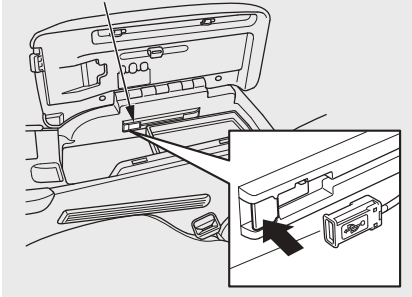

1. Push the release button to release the USB adapter cable.

DOCK CONNECTOR

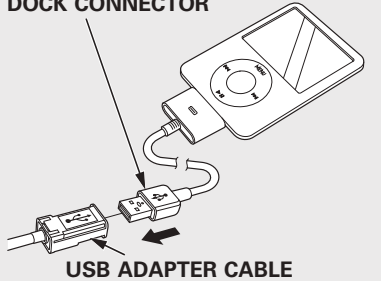

USB ADAPTER CABLE

2. Connect your dock connector to the iPod correctly and securely.
3. Install the dock connector to the USB adapter cable securely.

If the iPod indicator does not appear in the center display, check the connections, and try to reconnect the iPod a few times.

If the audio system still does not recognize the iPod, the iPod may need to be reset. Follow the instructions that came with your iPod, or you can find reset instructions online at www.apple.com/ipod.

CONTINUED

Playing an iPod (Models without navigation system)

Text Data Display Function

Each time you press the DISP/MODE button, the display mode switches between the album name, the song name, the artist name, or name off (which turns off the text display).

The center display shows up to about 16 characters of the selected data. If the text data has more than 16 characters, you will see the first 16 characters and the ► indicator in the center display. Press and hold the DISP/MODE button until the next 16 characters are shown.

To Change or Select Files

Use the SEEK/SKIP bar while an iPod is playing to select passages and change files.

SKIP – Each time you press and release the ►► side of the SEEK/SKIP bar, the system skips forward to the beginning of the next file. Press and release the ◀◀ side of the bar, to skip backward to the beginning of the current file. Press it again to skip to the beginning of the previous file.

To move rapidly within a file, press and hold either side (►► or ◀◀) of the SEEK/SKIP bar.

To Select a File from iPod Menu



You can also select a file from any list on the iPod menu: playlists, artists, albums, and songs, by using the SOUND/CLOCK button and PWR/VOL knob. Press and release the SOUND/CLOCK button to switch the display to an iPod menu, then turn the PWR/VOL knob to select a desired list. Press and release the SOUND/CLOCK button to set your selection.

Playing an iPod (Models without navigation system)

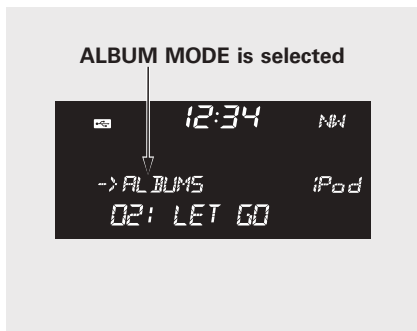

The center display shows items on the selected list. Press either side of the TUNE/FOLDER bar repeatedly. After making a selection, wait for a few seconds to set your selection.

If you select “ALL,” all available files on the selected list are played.

To Select Repeat or Shuffle Mode:

You can select any type of repeat and shuffle mode by using the RPT button or the A.SEL/RDM button.

REPEAT – This feature continuously plays a file. To activate the repeat feature, press the RPT button. You will see “RPT” in the center display. To turn it off, press the RPT button again.

SHUFFLE ALL – This feature plays all available files in a selected list (playlists, artists, albums or songs) in random order. To activate the shuffle all feature, press the A.SEL/RDM button. You will see “RDM” in the center display. To turn it off, press and hold the A.SEL/RDM button.

SHUFFLE ALBUM – This feature plays all available albums in a selected list (playlists, artists, albums or songs) in random order. The files in each album are played in the recorded order. To activate the shuffle album feature, press the A.SEL/RDM button repeatedly. You will see “F-RDM” in the center display. To turn it off, press and hold the A.SEL/RDM button.

Each time you press the A.SEL/RDM button, the mode changes from shuffle all play to shuffle album play, then to normal play.

NOTE:

Available operating functions vary on models or versions. Some functions may not be available on the vehicle's audio system.

CONTINUED

Playing an iPod (Models without navigation system)

To Stop Playing Your iPod

To play the radio, press the AM/FM, or «ⓧ» button. Press the CD/AUX button to switch between disc (if a disc is loaded), *Bluetooth*® Audio, and the iPod.

Disconnecting an iPod

You can disconnect the iPod at any time when you see the “OK to disconnect” message* in the iPod display. Always make sure you see the “OK to disconnect” message in the iPod display before you disconnect it. Make sure to follow the iPod's instructions on how to disconnect the dock connector from the USB adapter cable.

*: The displayed message may vary on models or versions. On some models, there is no message to disconnect.

If you reconnect the same iPod, the system may begin playing where it left off, depending on what mode the iPod is in when it is reconnected.

iPod Error Messages

For information, see page [203](#).

iPod Error Messages (Models without navigation system)

If you see an error message in the center display while playing an iPod, find the solution in the chart to the right. If you cannot clear the error message, take your vehicle to your dealer.

| Error Message | Cause | Solution |
|--|-----------------------------|--|
| USB ERROR | USB ROM error | There is a problem with the USB adapter unit. |
| BAD USB DEVICE PLEASE CHECK OWNERS MANUAL | Abnormal power source | Appears when the overcurrent protection feature of the system stops supplying power to USB because an incompatible device is connected. Disconnect the device. Then, turn the audio system off, and turn it on again. Do not reconnect the device that caused the error. |
| NO SONG | No files in iPod | Appears when the iPod is empty. Store some files in the iPod. |
| UNSUPPORTED | Use of unsupported device | Appears when an unsupported device is connected. Disconnect the device. |
| UNSUPPORTED VER. | Use of unsupported iPod | Appears when an unsupported iPod is connected. See page 198 for specification information on iPods. If it appears when a supported iPod is connected, update the iPod software to the newer version. |
| CONNECT RETRY | Recognition failure of iPod | Appears when the system does not acknowledge the iPod. Reconnect the iPod. |

Playing a USB Flash Memory Device (Models without navigation system)

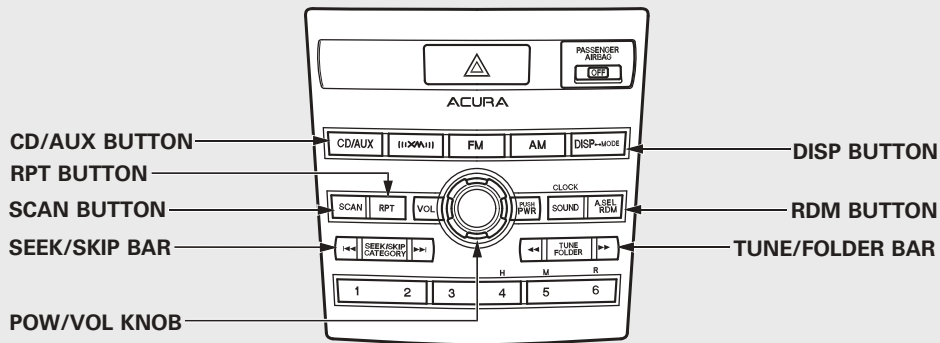
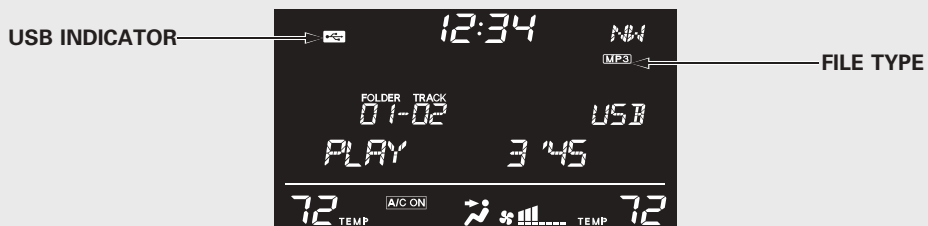

U.S. model is shown.

Playing a USB Flash Memory Device (Models without navigation system)

To Play a USB Flash Memory Device

This audio system can operate the audio files on a USB flash memory device with the same controls used for the in-dash disc changer. To play a USB flash memory device, connect it to the USB adapter cable in the console compartment, then press the CD/AUX button. The ignition switch must be in the ACCESSORY (I) or ON (II) position.

The audio system reads and plays the audio files on the USB flash memory device in MP3, WMA or AAC* formats. Depending on the format, the display shows MP3, WMA or AAC when a USB flash memory device is playing. The USB flash memory device limit is up to 700 folders or up to 65535 files.

*: Only AAC format files recorded with iTunes are playable on this audio unit.

The recommended USB flash memory devices are 256 MB or higher, and formatted with the FAT file system. Some digital audio players may be compatible as well.

Some USB flash memory devices (such as devices with security lock-out features, etc.) will not work in this audio unit.

NOTE:

- Do not use a device such as a card reader or hard drive as the device or your files may be damaged.
- Do not connect your USB flash memory device using a hub.
- Do not use an extension cable to the USB adapter cable equipped with your vehicle.
- Do not keep a USB flash memory device in the vehicle. Direct sunlight and high heat will damage it.

- We recommend backing up your data before playing a USB flash memory device.
- Depending on the type and number of files, it may take some time before they begin to play.
- Depending on the software the files were made with, it may not be possible to play some files, or display some text data.
- Some devices cannot be powered or charged via the USB adapter, if this is the case use the accessory adapter to supply power to your device.

CONTINUED

Playing a USB Flash Memory Device (Models without navigation system)

The specifications for compatible MP3 files are:

- Sampling frequency:
32/44.1/48 kHz (MPEG1)
24/22.05/16 kHz (MPEG2)
- Bitrate:
32/40/48/56/64/80/96/112/128/
160/192/224/256/320/VBR kbps
(MPEG1)
8/16/24/32/40/48/56/64/80/96/
112/128/160/VBR kbps (MPEG2)
- Supported standards:
MPEG1 Audio Layer3
MPEG2 Audio LSF Layer3
- Partition: Top partition only
- Maximum layers: 8

The specifications for compatible WMA files are:

- Sampling frequency:
32/44.1/48 kHz
- Bitrate:
48–320/VBR kbps (Max 384)
- Supported standards: WMA
version 7/8/9
- Partition: Top partition only
- Maximum layers
(including ROOT): 8 layers

The specifications for compatible AAC files are:

- Sampling frequency: 8/11.025/12/
16/22.05/24/32/ 44.1/48 kHz
- Bitrate: 48–320 kbps
- Supported standards: MPEG4/
AAC LC MPEG2/AAC LC
- Partition: Top partition only
- Maximum layers: 8

Even if recorded in MP3, WMA or AAC format, unsupported files cannot be played. If the system finds an unsupported file, the screen displays UNPLAYABLE, and then skips to the next file.

Playing a USB Flash Memory Device (Models without navigation system)

Connecting a USB Flash Memory Device

USB ADAPTER CABLE

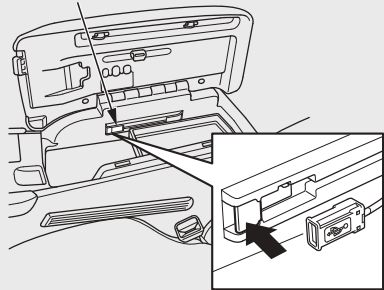

1. Push the release button to release the USB adapter cable.

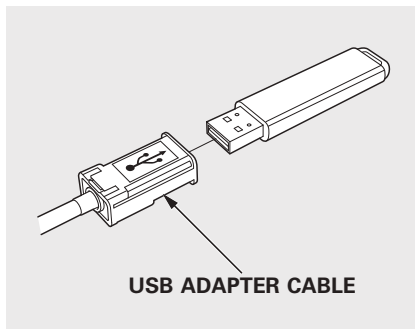

2. Connect the USB flash memory device to the USB adapter cable correctly and securely.

When the USB flash memory device is connected, the USB indicator is shown in the center display.

Text Data Display Function

Each time you press the DISP/MODE button, the display mode shows you in sequence, the folder name, the file name, the artist name, the album name, the song name, or name off (which turns off the text display).

The center display shows up to about 16 characters of the selected data. If the text data has more than 16 characters, you will see the first 16 characters and the ► indicator in the center display. Press and hold the DISP/MODE button until the next 16 characters are shown.

CONTINUED

Playing a USB Flash Memory Device (Models without navigation system)

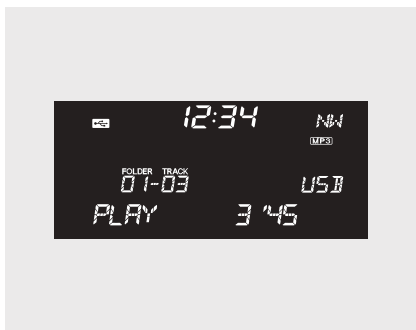

FOLDER SELECTION – To select a different folder, press and release either side of the TUNE/FOLDER bar. Press the ► side to skip to the next folder, and press the ◀ side to skip to the beginning of the previous folder.

To Change or Select Files

Use the SKIP bar while a USB flash memory device is playing to change files.

SKIP – Each time you press and release the ► side of the SEEK/SKIP bar, the system skips forward to the beginning of the next file. Press and release the ◀ side of the bar, to skip backward to the beginning of the current file. Press it again to skip to the beginning of the previous file.

To move rapidly within a file, press and hold either side (► or ◀) of the SEEK/SKIP bar.

To Select Repeat, Random or Scan Mode:

You can select any type of repeat, random and scan modes by using the RPT button, A.SEL/RDM button, or SCAN button.

REPEAT – This feature continuously plays a file. To activate the repeat feature, press the RPT button. You will see “RPT” in the center display. To turn it off, press and hold the RPT button.

Playing a USB Flash Memory Device (Models without navigation system)

FOLDER REPEAT – This feature replays all the files in the selected folder in the order they are stored. To activate the folder repeat feature, press the RPT button repeatedly. You will see “F-RPT” in the center display. To turn it off, press and hold the RPT button.

Each time you press and release the RPT button, the mode changes from file repeat to folder repeat, then to normal play.

FOLDER RANDOM – This feature plays the files in the selected folder in random order. To activate the folder random feature, press the A.SEL/RDM button. You will see “F-RDM” in the center display. To turn it off, press and hold the A.SEL/RDM button.

RANDOM – This feature plays all the files in random order. To activate the track random feature, press the A.SEL/RDM button repeatedly. You will see “RDM” in the center display. To turn it off, press and hold the A.SEL/RDM button.

Each time you press and release the A.SEL/RDM button, the mode changes folder random to random play, then to normal play.

SCAN – This feature samples all files in the selected folder in the order they are stored. To activate the scan feature, press the SCAN button. You will see “SCAN” in the center display. You will get a 10 second sampling of each file in the folder. Press and hold the SCAN button to get out of the scan mode and play the last file sampled.

FOLDER SCAN – This feature samples the first file in each folder in the order they are stored. To activate the folder scan feature, press the SCAN button repeatedly. You will see “F-SCAN” in the center display. You will get a 10 second sampling of the first file in each folder. Press and hold the SCAN button to get out of the folder scan mode and play the last file sampled.

CONTINUED

Playing a USB Flash Memory Device (Models without navigation system)

Each time you press and release the SCAN button, the mode changes from file scan to folder scan, then to normal play.

To Stop Playing a USB Flash Memory Device

To play the radio, press the FM, AM or «» button. Press the CD/AUX button to switch between disc (if a disc is loaded) and *Bluetooth*[®] Audio.

You can also press the MODE button on the steering wheel to change modes.

If you reconnect the same USB flash memory device, the system will begin playing where it left off.

Disconnecting a USB Flash Memory Device

You can disconnect the USB flash memory device at any time even if the USB mode is selected on the audio system. Always follow the USB flash memory device's instructions when you remove it.

When you disconnect the USB flash memory device while it is playing, the center display shows "USB NO DATA."

If you reconnect the same USB flash memory device, the system will begin playing where it left off.

USB Flash Memory Device Error Messages

For information, see page [211](#).

USB Flash Memory Device Error Messages (Models without navigation system)

If you see an error message in the center display while playing a USB flash memory device, find the solution in the chart to the right. If you cannot clear the error message, take your vehicle to your dealer.

| Error Message | Cause | Solution |
|--|--|--|
| USB ERROR | USB ROM error | There is a problem with the USB adapter unit. |
| BAD USB DEVICE PLEASE CHECK OWNERS MANUAL | Abnormal power source | Appears when the overcurrent protection feature of the system stops supplying power to USB because an incompatible device is connected. Disconnect the device. Then, turn the audio system off, and turn it on again. Do not reconnect the device that caused the error. |
| UNPLAYABLE FILE | Use of unsupported files | Appears when the files in the USB flash memory device are DRM or an unsupported format. This error message appears for a few seconds, then plays the next song. |
| NO SONG | No files in USB flash memory device | Appears when the USB flash memory device is empty or there are no MP3, WMA, or AAC files in the USB flash memory device. Save some MP3, WMA, or AAC files in the USB flash memory device. |
| UNSUPPORTED | Use of unsupported USB flash memory device | Appears when an unsupported device is connected. See page 206 for specification information on USB flash memory devices. If it appears when the supported device is connected, reconnect the device. |

Bluetooth® Audio System (Models without navigation system)

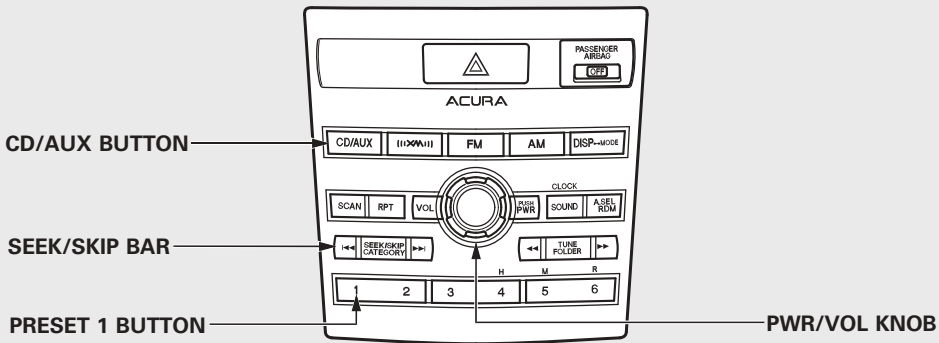
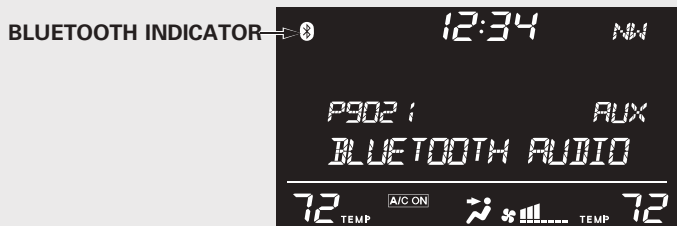

U.S. model is shown.

Bluetooth® Audio System (Models without navigation system)

Your vehicle is equipped with a *Bluetooth*® Audio system, which allows you to listen to streaming audio from your *Bluetooth*® Audio compatible phone. This function is only available on *Bluetooth*® Audio Compatible phones that are paired and linked to the vehicle's *Bluetooth*® HandsFreeLink® (HFL) system (see page 313).

Not all Bluetooth-enabled phones with streaming audio capabilities are compatible with the system. You can find an approved phone by visiting www.acura.com/handsfreelink, or by calling the HandsFreeLink® consumer support at 1-888-528-7876. In Canada, visit www.acura.ca, or call 1-888-9-ACURA-9.

NOTE: In some states, it may be illegal to perform some data device functions while driving.

To Play *Bluetooth*® Audio Files

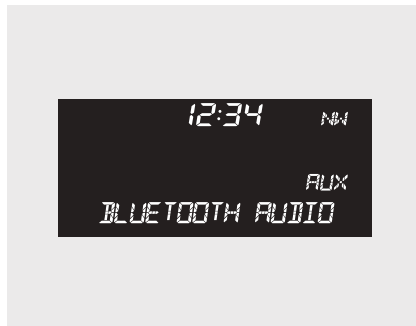

Make sure that your phone is paired and linked to the HFL. Press the DISC/AUX button* with the ignition switch in the ACCESSORY (I) or ON (II) position. When the phone is recognized, you will see the *Bluetooth*® Audio message and indicator on the center display, and the system begins to play.

If more than one phone is paired to the HFL system, there will be delay before the system begins to play.

To begin to play the audio files, you may need to operate your phone. If so, follow the phone maker's operating instructions.

*: If an iPod, USB flash memory device, or audio unit connected to the auxiliary input jack was selected at the last mode, you will see iPod, USB, or AUX in the center display. Push the DISC/AUX button again to play audio files from your *Bluetooth*® Audio phone.

CONTINUED

Bluetooth® Audio System (Models without navigation system)

In the following conditions, If you cannot see the *Bluetooth®* indicator on the center display.

- The phone is not linked to HFL.
- The phone is not turned on.
- The phone is not in the vehicle.
- Another HFL compatible phone, which is not compatible for *Bluetooth®* Audio, is already connected.

If your *Bluetooth®* Audio compatible phone does not operate as described, make sure it is an Acura approved phone. To find out if your phone is approved, go to www.acura.com/handsfreelink (in Canada, www.acura.ca), or call the HandsFreeLink® consumer support at (888) 528-7876.

To skip a file

Press the ►► side of the SEEK/SKIP bar to skip forward, and press the ◀◀ side to skip backward to the beginning of the current file. Push the ◀◀ side again to skip to the previous file.

To pause or resume a file

The resume/pause mode can stop playing a file temporarily. Press the preset 1 button to pause and press it again to resume a file.

NOTE: The pause function may not be available on some phone devices.

To switch to HFL mode

If you receive a call when the *Bluetooth®* Audio is playing, press the Talk button on the steering wheel. The display switches to the HFL mode (see page 309).

After ending the call, press the HFL Back button to go back to the *Bluetooth®* Audio mode.

If you receive a call while the system is in the pause mode, the mode will be canceled and *Bluetooth®* Audio will continue to play.

Bluetooth® Audio System (Models without navigation system)

To turn off the Bluetooth® Audio mode

Select any other audio mode by pressing a button: FM, AM, «(XMM)» or CD/AUX (if a disc is loaded), on the audio control panel or press the mode button on the steering wheel repeatedly to select another audio mode. If iPod or USB flash memory device is connected to the USB adapter cable or audio unit is connected to AUX jack, pressing the CD/AUX button also changes a mode.

Switching to another mode pauses the music playing from your phone.

As required by the FCC:

This device complies with Part 15 of the FCC rules. Operation is subject to the following two conditions: (1) This device may not cause harmful interference, and (2) this device must accept any interference received, including interference that may cause undesired operation.

Changes or modifications not expressly approved by the party responsible for compliance could void the user's authority to operate the equipment.

This device complies with Industry Canada Standard RSS-210.

Operation is subject to the following two conditions: (1) this device may not cause interference, and (2) this device must accept any interference that may cause undesired operation of the device.

Audio System (Models with navigation system)

Interface Dial

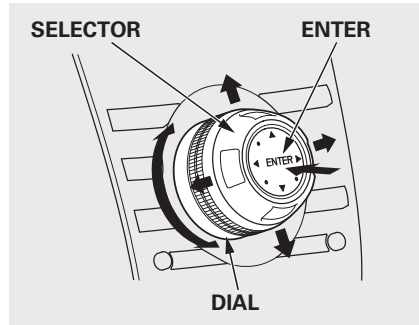

Most audio system functions can still be controlled by standard buttons, bars, and knob, but some functions can only be accessed using the interface dial. The interface dial has two parts, a knob and a selector.

When you operate the audio system with the interface dial, press the **AUDIO** button on the control panel to display the audio control on the navigation display.

The knob turns left and right. Use it to make selections or adjustments to a list or menu on the screen.

The selector can be pushed left, right, up, down, and in. Use the selector to scroll through lists, to select menus, and to highlight menu items. When you make a selection, push the center of the selector (**ENTER**) to go to that selection.

You can operate the audio system with the control buttons on the CD changer unit without displaying the audio control display on the navigation display. The audio setting will be shown on the upper display.

Voice Control System

The audio system for your vehicle can also be operated by voice control. See the navigation system manual for complete details.

Playing the FM/AM Radio (Models with navigation system)

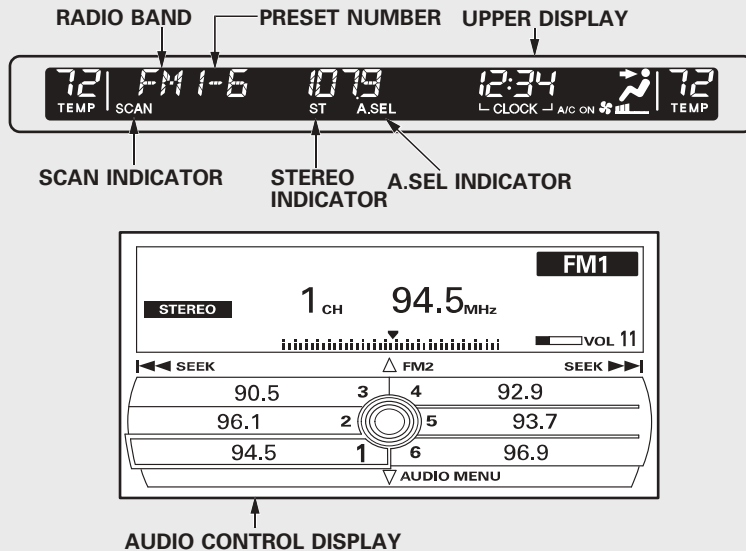

U.S. model is shown.

CONTINUED

Playing the FM/AM Radio (Models with navigation system)

U.S. model is shown.

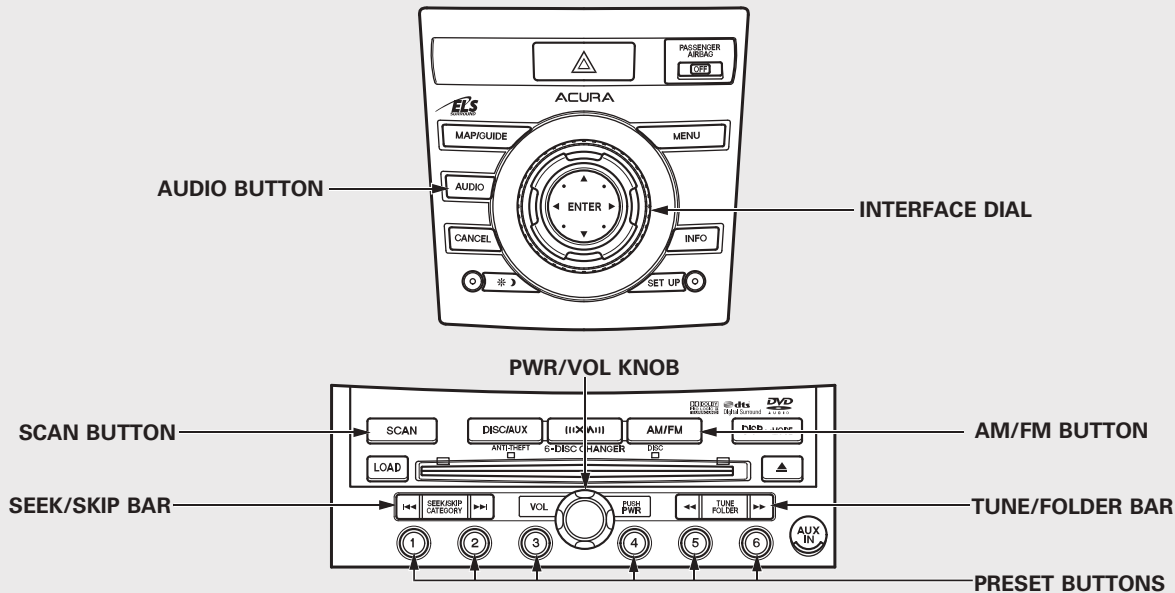

Playing the FM/AM Radio (Models with navigation system)

To Play the Radio

The ignition switch must be in the ACCESSORY (I) or the ON (II) position. Press the AUDIO button to view the audio control display. Turn the system on by pressing the PWR/VOL knob or the AM/FM button. Adjust the volume by turning the PWR/VOL knob.

The band and frequency the radio was last tuned to are shown on the upper display. To change bands, press the AM/FM button. You can also change bands with the interface dial. Press the AUDIO button to view the audio control display and the band changes to FM1, FM2, or AM each time you push the selector up. On the FM bands, "STEREO" will be shown on the audio control display. "ST" will also appear on the upper display if the station is broadcasting in stereo. Stereo reproduction on AM is not available.

XM Radio information is available on page [228](#).

To Select a Station

You can use any of five methods to find radio stations on the selected band: TUNE, SEEK, SCAN, the preset buttons or icons, and AUTO SELECT.

TUNE – Use the TUNE/FOLDER bar to tune the radio to a desired frequency. Press the ►► side of the bar to tune to a higher frequency, and the ◀◀ side of the bar to tune to a lower frequency.

If you press and hold the ◀◀ or ►► side of the bar, the frequency will begin to change rapidly. It will stop when you release it.

CONTINUED

Playing the FM/AM Radio (Models with navigation system)

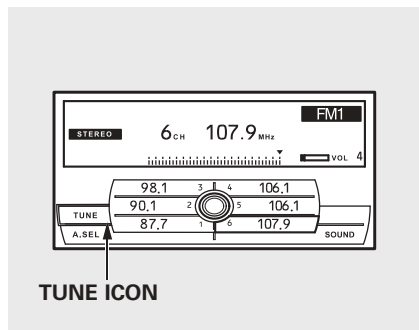

To tune with the interface dial, press the AUDIO button to view the audio control display, then push the selector down, and turn the dial to TUNE. Then press ENTER on the selector, and turn the dial to the desired frequency. To exit the TUNE mode, press ENTER again.

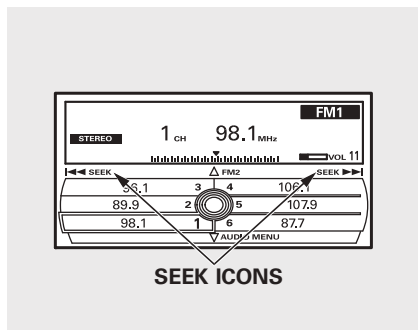

SEEK – The SEEK function searches up and down from the current frequency to find a station with a strong signal. To activate it, press the ◀◀ or ▶▶ side of the SEEK/SKIP bar, then release it.

To activate the seek function with the interface dial, press the AUDIO button to view the audio control display, then push the selector on the interface dial to the right or left.

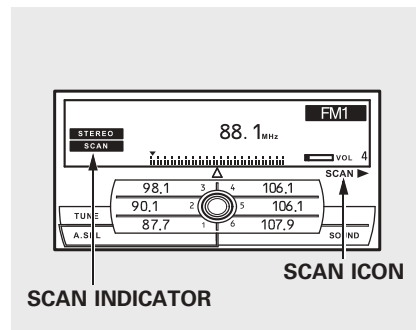

SCAN – The SCAN function samples all stations with strong signals on the selected band. To activate it, press the SCAN button, then release it. You will see “SCAN” on the upper display.

Playing the FM/AM Radio (Models with navigation system)

To activate the scan function with the interface dial, press the AUDIO button to view the audio control display, then push down the selector on the interface dial, and push the selector to the right. You will see “SCAN” on the audio control display.

When it finds a strong signal, it will stop and play that station for about 10 seconds. If you do nothing, the system will then scan for the next strong station and play it for 10 seconds. When it plays a station that you want to listen to, press the SCAN button again, or push the interface selector to the right again.

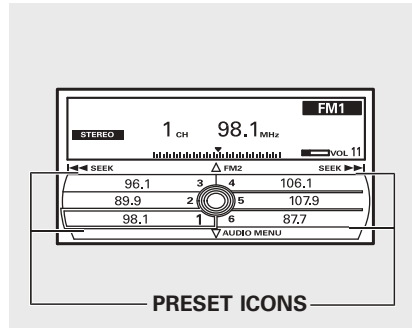

Preset – Each preset button/icon can store one frequency on AM and two frequencies on FM. To view the preset icons on the audio control display, push the AUDIO button.

1. Select the desired band, AM or FM. FM1 and FM2 let you store two sets of FM frequencies with the preset buttons (on-screen icons).
2. Use the TUNE, SEEK, or SCAN function to tune the radio to a desired station.
3. Pick a preset number (1 – 6), you want for that station. Press the preset button, and hold it until you hear a beep.

CONTINUED

Playing the FM/AM Radio (Models with navigation system)

To store the frequency on a preset icon, turn the interface dial to select a desired preset icon. The selected preset icon will be highlighted. Press and hold ENTER on the selector for more than 2 seconds to store the frequency.

- Repeat steps 1 through 3 to store a total of six stations on AM and twelve stations on FM.

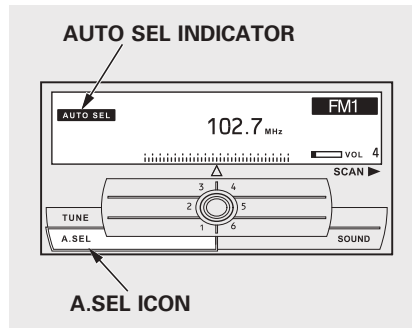

AUTO SELECT – If you are traveling and can no longer receive your preset stations, you can use the auto select feature to find stations in the local area.

To activate AUTO SELECT, press the AUDIO button to view the audio control display. Push the interface selector down to scroll down the display, turn the knob to A.SEL, then press ENTER on the interface selector. You will see “AUTO SEL” flashing in the audio control display, and “A.SEL” on the upper display. Then, the system goes into scan mode for several seconds.

The system stores the frequencies of six AM and twelve FM stations in the preset buttons.

You will see “0” displayed if auto select cannot find a strong station for every preset button.

Playing the FM/AM Radio (Models with navigation system)

If you do not like the stations auto select has stored, you can store other frequencies on the preset buttons (icons) as previously described.

To turn off auto select, press ENTER on the interface selector again. This restores the presets you originally set.

Radio Frequencies and Reception

For information on AM/FM radio frequencies and reception, see page [287](#).

Adjusting the Sound

For information, see page [224](#).

Playing the FM/AM Radio (Models with navigation system)

Adjusting the Sound

BASS, TREBLE, BALANCE, and FADER are each adjustable. You can also adjust the strength of the sound coming from the center and subwoofer speakers. In addition, you can set the Dolby PL (ProLogic) II and Speed-sensitive volume compensation (SVC).

To adjust each mode, press the AUDIO button to view the audio control display, push the interface selector down, and turn the interface dial to SOUND. Then press ENTER on the selector.

Select the mode you want to adjust by pushing the interface selector up or down, or by turning the interface dial.

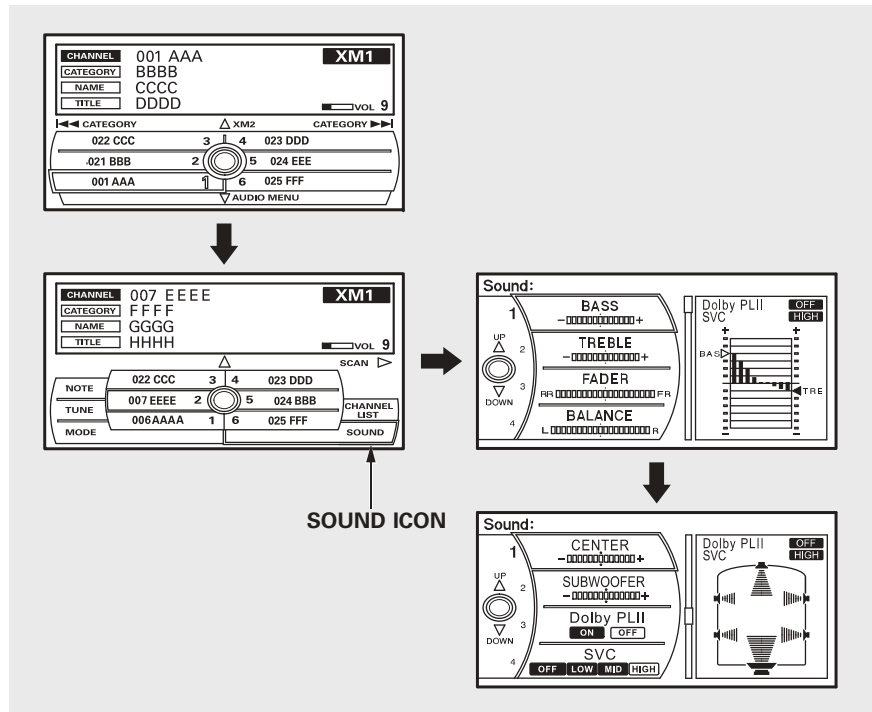

Playing the FM/AM Radio (Models with navigation system)

CURRENT SETTING

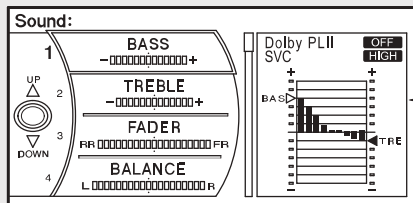

CURRENT SETTING

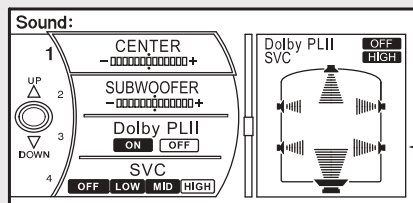

The current setting is also shown on the upper display.

The system will automatically return the display to the selected audio mode about 10 seconds after you stop adjusting a mode.

BASS/TREBLE – To adjust bass and treble, select BASS or TREBLE, and press ENTER on the interface selector. The current setting is shown on the audio control display. Turn the interface dial to the desired level (–6 to +6), and enter your selection by pressing ENTER.

CONTINUED

Playing the FM/AM Radio (Models with navigation system)

FADER/BALANCE – These modes adjust the strength of the sound coming from each speaker. Fader adjusts the front-to-back strength, while balance adjusts the side-to-side strength. To adjust fader and balance, select FADER or BALANCE, then press ENTER on the interface selector. The current setting is shown on the audio control display. Turn the interface dial to the desired level (fader: F9 to R9, balance: L9 to R9), and enter your selection by pressing ENTER. To equalize the fader or balance, turn the interface dial until the readings on the sound grid come to the center of the adjustment bar.

CENTER/SUBWOOFER – To adjust the strength of the sound from the center or subwoofer speaker, select it and press ENTER on the interface selector. Turn the interface dial to the desired level (– 6 to + 6), and enter your selection by pressing ENTER. The current setting is shown on the audio control display. Even if the adjustment level reaches – 6, the sub woofer is not turned off.

Dolby PL (Prologic) II – Dolby PL (Prologic) II signal processing creates multi-channel surround sound from the audio signal recorded with 2 channel stereo sources. Dolby prologic II can only be activated when listening to CD (CD-DA, MP3/WMA), XM radio, and AUX. When it activates, “DPL II” is shown on the upper display.

Playing the FM/AM Radio (Models with navigation system)

To set this feature on or off, select Dolby PL II, and press ENTER on the interface selector. Rotate the interface dial to ON or OFF, and press ENTER.

Manufactured under license from Dolby Laboratories. “Dolby”, “ProLogic”, and the double-D symbol are trademarks of Dolby Laboratories.

Speed-sensitive volume compensation (SVC) – The SVC mode controls the volume based on vehicle speed. The faster you go, the louder the audio volume becomes. As you slow down, the audio volume decreases.

The SVC has four modes: OFF, LOW, MID, and HIGH. The default setting is MID.

Turn the interface dial to the desired setting, and enter your selection by pressing ENTER.

Playing the XM® Radio (Models with navigation system)

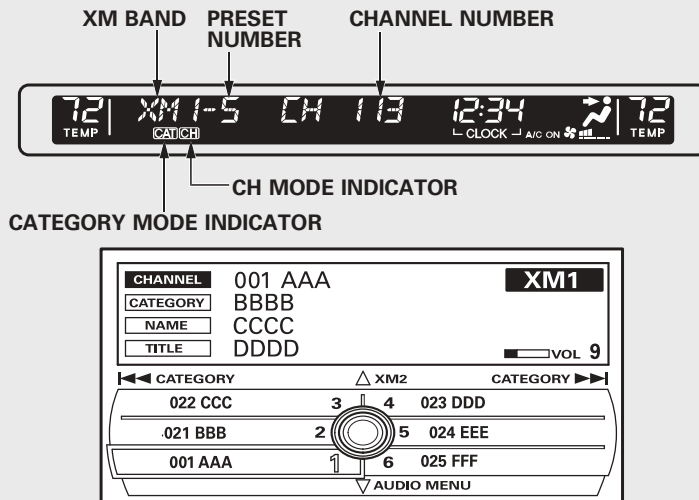

U.S. model is shown.

Playing the XM® Radio (Models with navigation system)

U.S. model is shown.

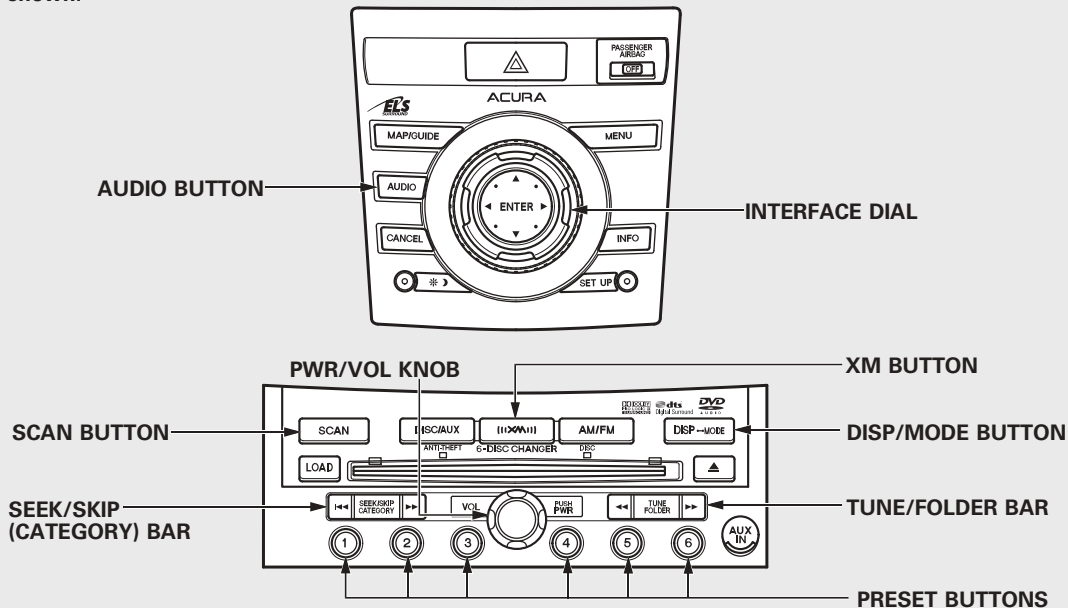

CONTINUED

Playing the XM® Radio (Models with navigation system)

Your vehicle is capable of receiving XM® Radio anywhere in the United States and Canada, except Hawaii, Alaska, and Puerto Rico. XM is a registered trademark of Sirius XM Radio Inc. and XM CANADA® is a registered business name of Canadian Satellite Radio Inc.

XM Radio receives signals from two satellites to produce clear, high-quality digital reception. It offers many channels in several categories. Along with a large selection of different types of music, XM Radio also allows you to view channel and category selections in the upper display and the audio control display.

Operating the XM Radio

To listen to the XM Radio, turn the ignition switch to the ACCESSORY (I) or ON (II) position. Push the PWR/VOL knob to turn on the audio system, and press the «**XM**» button. To view the audio control display, press the AUDIO button. Adjust the volume turning the PWR/VOL knob. The last channel you listened to will show on the upper display.

DISP – Each time you press and release the DISP/MODE button, the upper display changes in the following sequence: Channel name, category, artist name, and music title.

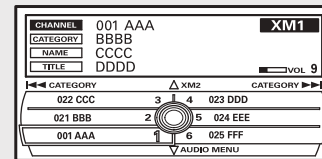

MODE – To switch between the category mode and channel mode, press and hold the DISP/MODE button until the mode changes. A “CH” (channel) or “CAT” (category) mode indicator appears on the upper display.

Playing the XM® Radio (Models with navigation system)

To Select a Channel

When in the satellite radio mode, you can use any of four methods to find channels: TUNE, SEEK/SKIP (CATEGORY), SCAN, and the preset icons.

You can also switch between the category mode and channel mode on the audio control display. Press the AUDIO button to view the display, then push down the selector on the interface dial. Rotate the interface dial to select the mode. Press ENTER on the selector to enter your selection.

TUNE – Press the TUNE/FOLDER bar to change channel selections. Press the ► side of the bar to tune to higher numbered channels, and the ◀ side of the bar to tune to lower numbered channels. In the category mode, you can only select channels within that category.

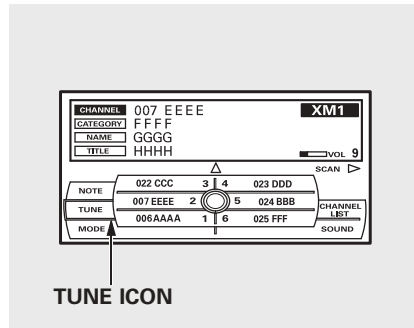

You can also change channel selections on the audio control display. Press the AUDIO button to view the display, then push down the selector on the interface dial. Rotate the interface dial to select TUNE. Press ENTER on the selector to enter your selection. Rotate the interface knob to the desired channel. In the category mode, you can only select channels within that category.

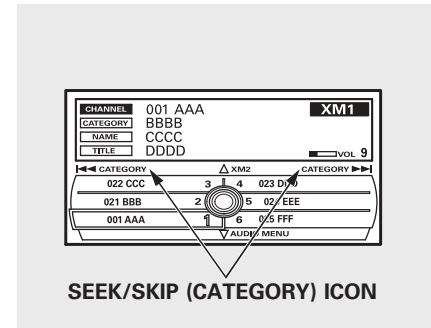

SEEK/SKIP (CATEGORY) – Press either side of the SEEK/SKIP (CATEGORY) bar (◀◀ or ▶▶) to select another category.

You can also change the category on the audio control display. Press the AUDIO button to view the display, then push the selector on the interface dial to the right side or left side to select another category.

CONTINUED

Playing the XM® Radio (Models with navigation system)

SCAN – The scan function gives you a sampling of all channels while in the channel mode. In the category mode, only the channels within that category are scanned. To activate scan, press the SCAN button. The system plays each channel in numerical order for a few seconds, then selects the next channel. When you hear a channel you want to continue listening to, press the button again.

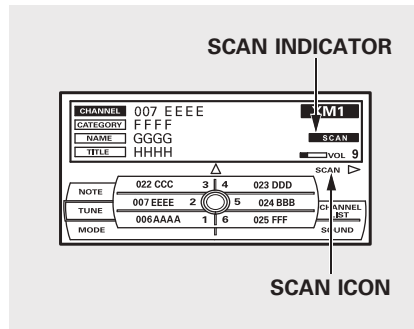

You can also scan the channels on the audio control display. Press the AUDIO button to view the display, then push down the selector on the interface dial. Push the selector to the right to activate scan feature.

Preset – You can store up to 12 preset channels using the preset buttons/icons. Each button/icon stores one channel from the XM1 band and one channel from the XM2 band.

To store a channel:

1. Press the «XM» button. To view the audio control display, press the AUDIO button. Either XM1 or XM2 will be shown on the display.
2. Use the tune, seek, or scan function to tune to a desired channel.

In category mode, only channels within that category can be selected. In channel mode, all channels can be selected.

Playing the XM® Radio (Models with navigation system)

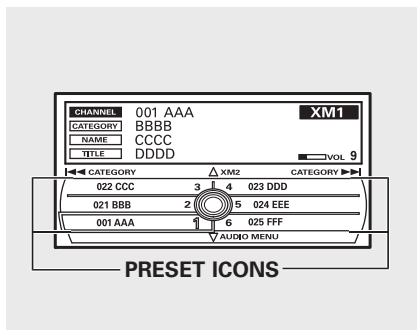

- Pick a preset number for the channel you want to store. Press and hold the appropriate button until you hear a beep.

To store the channel on a preset icon, rotate the interface dial to select a desired preset icon. The selected preset icon will be highlighted. Press and hold ENTER on the selector for more than 2 seconds to store the channel.

- Repeat steps 2 and 3 to store the first six channels.
- Press the « XM » button again. The other XM band will be shown. Store the next six channels by repeating steps 2 and 3.

Once a channel is stored, press and release the proper preset button to tune to it.

Adjusting the Sound

For information, see page [224](#).

XM Radio Reception

For information, see page [235](#).

CONTINUED

Playing the XM® Radio (Models with navigation system)

XM Radio Display Messages

“LOADING” — XM is loading the audio or program information.

“OFF AIR” — The channel currently selected is no longer broadcasting.

“UPDATING” — The encryption code is being updated. Wait until the encryption code is fully updated. Channels 0 and 1 should still work normally.

“NO SIGNAL” — The signal is currently too weak. Move the vehicle to an area away from tall buildings, and with an unobstructed view of the southern horizon.

“ - - - - ” — The selected channel number does not exist, or is not part of your subscription, or this channel has no artist or title information at this time.

“ANTENNA” — There is a problem with the XM antenna. Please consult your dealer.

Playing the XM® Radio (Models with navigation system)

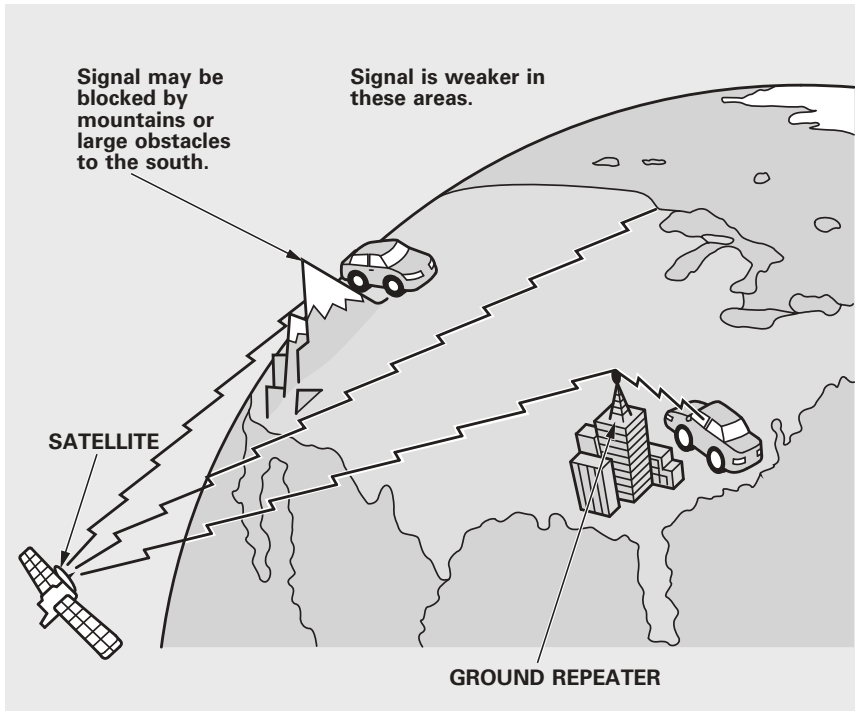

Satellite Radio Signals

Satellite radio receives signals from two satellites to produce clear, high-quality digital reception. It offers many channels in several categories. Along with a large selection of different types of music, satellite radio also allows you to view channel and category selections in the audio display.

The XM satellites are in orbit over the equator; therefore, objects south of the vehicle may cause satellite reception interruptions. To help compensate for this, ground-based repeaters are placed in major metropolitan areas.

Satellite signals are more likely to be blocked by tall buildings and mountains the farther north you travel from the equator.

CONTINUED

Playing the XM® Radio (Models with navigation system)

Depending on where you drive, you may experience reception problems. Interference can be caused by any of these conditions:

- Driving on the north side of an east/west mountain road.
- Driving on the north side of a large commercial truck on an east/west road.
- Driving in tunnels.

- Driving on a road beside a vertical wall, steep cliff, or hill to the south of you.
- Driving on the lower level of a multi-tiered road.
- Driving on a single lane road alongside dense trees taller than 50 ft. (15 m) to the south of you.

There may also be other geographic situations or structures that could affect satellite radio reception.

*As required by the FCC:
Changes or modifications not expressly approved by the party responsible for compliance could void the user's authority to operate the equipment.*

Playing the XM® Radio (Models with navigation system)

Note Function

If equipped.

This function stores the sound content played on the selected XM radio station with the channel, category, name, and title information.

To activate this function, press and hold the «XM» button for about 2 seconds while a song or passage which you want to store is playing.

The function records for about 10 seconds, enough for you to identify the selection when you play it back.

Once you store the recorded sound file, you can replay it and confirm the information. The system can store up to 30 sound files. If you continue to store more information, the oldest one will be deleted each time you add new information.

NOTE ICON

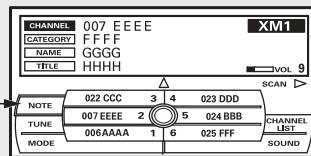

To replay and see the stored information, press the AUDIO button to select the audio control display.

Push down the selector knob to display the audio menu. Turn the selector knob to select NOTE, then press ENTER.

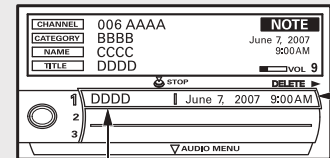

Turn the selector knob to select a sound file, then press ENTER. The audio control display shows the category, name and title information of the selected file.

CONTINUED

Playing the XM® Radio (Models with navigation system)

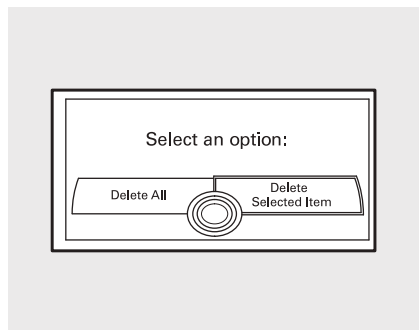

To delete a file, select it by turning the selector knob, then push it to the right. Select “Delete All” or “Delete Selected Item,” then press ENTER.

Receiving Radio Service

If your XM Radio service has expired or you purchased your vehicle from a previous owner, you can listen to a sampling of the broadcasts available on XM radio. With the ignition switch in the ACCESSORY (I) or the ON (II) position, push the PWR/VOL knob to turn on the audio system, and press the (« XM ») button. A variety of music types and styles will play.

If you decide to purchase XM Radio service, contact XM Radio at www.xmradio.com, or at 1-800-852-9696. In Canada, contact XM CANADA® at www.xmradio.ca, or at 1-877-209-0079. You will need to give them your radio I. D. number and your credit card number. To get your radio I.D. number, turn the TUNE knob until “0” appears in the display. Your I.D. will appear in the display.

After you've registered with XM Radio, keep your audio system in the satellite radio mode while you wait for activation. This should take about 30 minutes.

While waiting for activation, make sure your vehicle remains in an open area with good reception. Once your audio system is activated, “CAT” or “CH” will appear in the upper display, and you'll be able to listen to XM Radio broadcasts. XM Radio will continue to send an activation signal to your vehicle for at least 12 hours from the activation request. If the service has not been activated after 36 hours, contact XM Radio. In Canada, contact XM CANADA®.

Playing Discs (Models with navigation system)

Normal mode

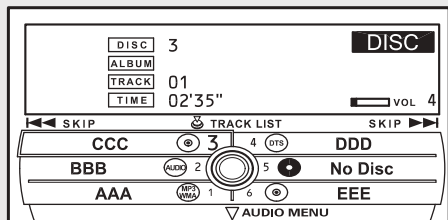
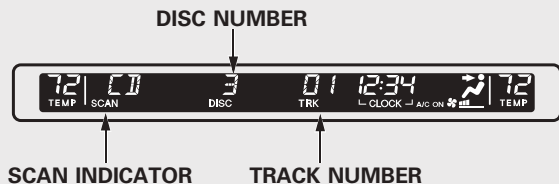

U.S. model is shown.

MP3/WMA mode

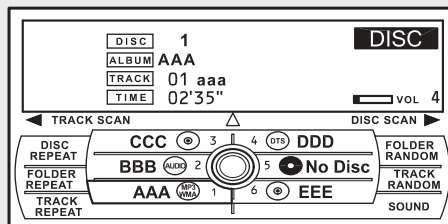
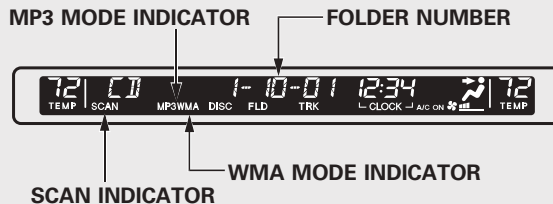

CONTINUED

Playing Discs (Models with navigation system)

U.S. model is shown.

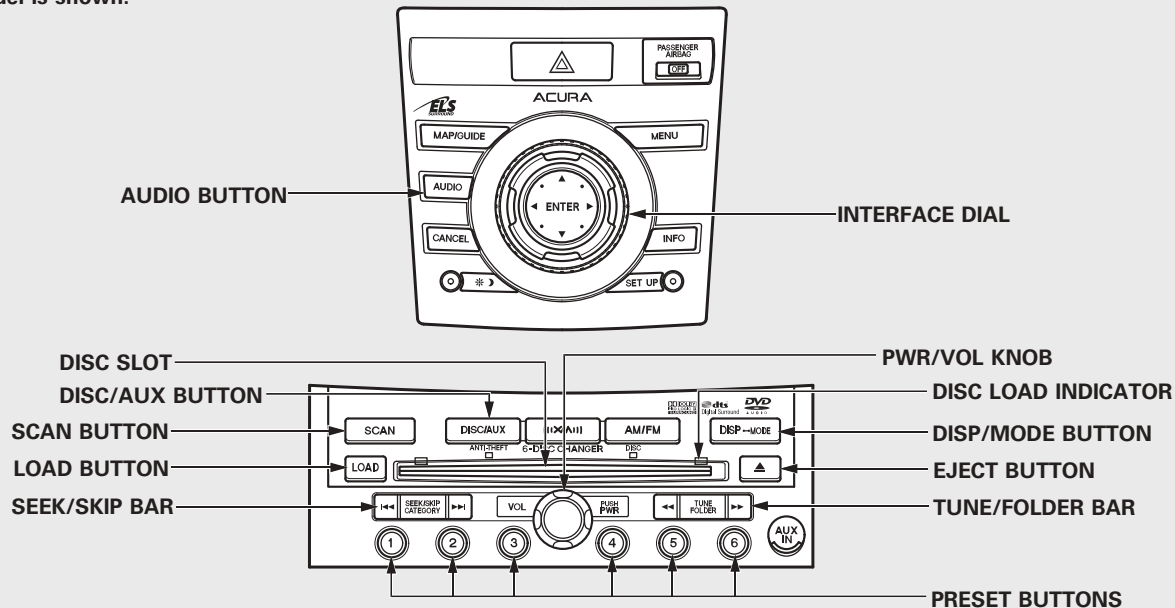

Playing Discs (Models with navigation system)

Your vehicle's audio system has an in-dash disc changer with the same controls used for the radio. To operate the disc changer, the ignition switch must be in the ACCESSORY (I) or the ON (II) position.

The disc changer can play these disc formats:

- CD (CD-DA)
- CD-R/RW
- DVD-A

The disc packages or jackets should have one of these marks.



The changer can also play MP3 or WMA format (see page 245).

DVD-A discs not meeting DVD verification standards may not be playable.

The changer cannot play DVD-V or DVD-R/RW formats.

Some CD-DA and CD-ROM mixed discs are not playable.

You cannot load and play 3-inch (8-cm) discs in this system.

NOTICE

Do not use discs with adhesive labels. The label can curl up and cause the disc to jam in the unit.

CONTINUED

Playing Discs (Models with navigation system)



Manufactured under license under U.S. Patent #'s: 5,451,942; 5,956,674; 5,974,380; 5,978,762; 6,487,535 & other U.S. and worldwide patents issued & pending. DTS and DTS Digital Surround are registered trademarks and the DTS logos and Symbol are trademarks of DTS, Inc. © 1996-2007 DTS, Inc. All Rights Reserved.

Loading Discs

To load multiple discs in one operation:

1. Press and hold the LOAD button on the changer unit until you hear a beep. You will see "BUSY" on the upper display, and the disc load indicator turns red and starts blinking.
2. Insert the disc into the disc slot when the disc load indicator turns green and "LOAD" appears in the upper display at the same time. Insert it only halfway; the drive will pull it in the rest of the way. You will see "BUSY" on the upper display, and the disc load indicator turns red again and blinks as the CD is loaded.
3. When the disc load indicator turns green and "LOAD" appears on the upper display again, insert the next CD in the slot.

Do not try to insert a disc until "LOAD" appears. You could damage the audio unit.

4. Repeat steps 1 through 3 until all six positions are loaded. If you are not loading all six positions, press the LOAD button again after the last CD has loaded. "DISC READ" appears on the upper display, then the system begins playing the last loaded.

If you stop loading discs before all six positions are filled, the system will wait for 10 seconds, stop the load operation, and begin playing the last disc loaded.

To load a single disc:

1. Press and release the LOAD button on the changer unit. You will see "BUSY" on the upper display, and the disc load indicator turns red and starts blinking.

Playing Discs (Models with navigation system)

2. Insert a disc into the disc slot when the disc load indicator turns green, and "LOAD" appears on the upper display at the same time. Insert the disc only about halfway; the drive will pull it in the rest of the way. You will see the disc number blinking on the upper display, and the disc load indicator turns red again and blinks as the CD is loaded.

Do not try to insert a disc until "LOAD" appears. You could damage the audio unit.

3. You will see "DISC READ" on the upper display, then the system begins to play the CD.

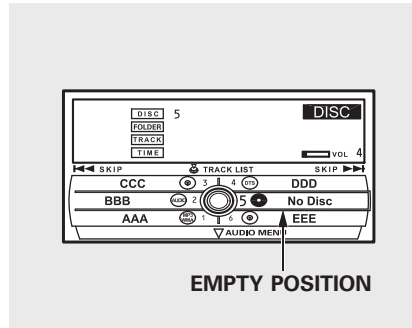

You can load a CD into an empty position while a CD is playing. Press the AUDIO button to view the audio control display. Select the empty position ("No Disc" is shown on the audio control display) by rotating the interface dial. Then press ENTER on the selector to enter your selection. The current CD stops playing and starts the loading sequence. The CD just loaded will play.

You can also select the empty position by pressing the appropriate preset button.

You can load a disc(s) in any mode (AM, FM, XM, or AUX) if you do not select an empty position.

You cannot select the empty position if there is no disc in the changer.

CONTINUED

Playing Discs (Models with navigation system)

To Play a Disc

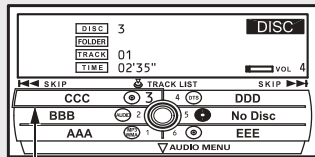

CURRENT DISC

Select the changer by pressing the DISC/AUX button. You will see the “CD” on the upper display. The system will begin playing the last selected CD in the CD changer.

If you want to see the list of the discs in the CD changer, press the AUDIO button to view the audio control display. You will see the current disc position highlighted.

When playing a CD (CD-DA), the audio control display shows disc number, album name, track number, and elapsed time. When playing a CD without this information, the number of the disc and track playing and the elapsed time are shown on the audio control display.

When the system reaches the end of the disc, it will advance to the beginning of the first track/file (in MP3/WMA mode) on the next disc, then play that track/file.

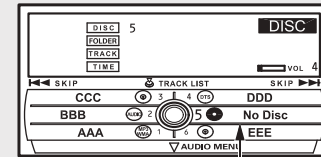

EMPTY POSITION

To select a disc, press an appropriate preset button (1 – 6), or select an appropriate preset icon by rotating the interface dial, then press ENTER on the interface selector. If you select an empty position (“No Disc” is shown) in the CD changer, the system will load a CD into the empty slot (see page 243).

Playing Discs (Models with navigation system)

Playing an MP3/WMA Disc

The CD changer can also play CD-Rs and CD-RWs compressed in MP3 and WMA format. When playing a disc in MP3 or WMA, you will see “MP3” or “WMA” on the upper display. A disc can support more than 99 folders, and each folder can hold up to 255 playable files.

When there are more than 99 folders on a disc, the upper display only shows two digits.

NOTE: If a file on an MP3 or WMA disc is protected by digital rights management (DRM), the audio unit displays **FORMAT**, and then skips to the next file.

When playing a CD compressed in MP3/WMA format, the audio control display shows disc number, folder name, file number, and elapsed time. When playing a CD without this information, the disc number, track number, and the elapsed time are shown on the audio control display.

If the disc has a complex structure, it will take a while to read the disc before the system begins to play it.

The specifications for compatible MP3 files are:

- Sampling frequency:
32/44.1/48 kHz (MPEG1)
24/22.05/16 kHz (MPEG2)
- Bitrate:
32/40/48/56/64/80/96/112/128/
160/192/224/256/320 kbps
(MPEG1)
8/16/24/32/40/48/56/64/80/96/
112/128/160 kbps (MPEG2)
- Compatible with variable bitrate
and multi-session
- Maximum layers
(including ROOT): 8 layers

CONTINUED

Playing Discs (Models with navigation system)

The specifications for compatible WMA files are:

- Sampling frequency:
32/44.1/48 kHz
- Bitrate:
48/64/80/96/128/160/192 kbps
- Compatible with variable bitrate and multi-session
- Maximum layers
(including ROOT): 8 layers

To Change or Select Tracks/Files

While a disc is playing you can use the SEEK/SKIP bar to select passages and change tracks (files in MP3/WMA mode).

In MP3/WMA mode, use the TUNE/FOLDER bar to select folders on the disc, and use the SEEK/SKIP bar to change files.

SEEK/SKIP – Each time you press and release the ►►| side of the SEEK/SKIP bar, the system skips forward to the beginning of the next track (file in MP3/WMA mode). Press and release the |◄◄ side of the bar to skip backward to the beginning of the current track/file. Press it again to skip to the beginning of the previous track/file.

To move rapidly within a track/file, press and hold the |◄◄ or ►►| side of the SEEK/SKIP bar.

Playing Discs (Models with navigation system)

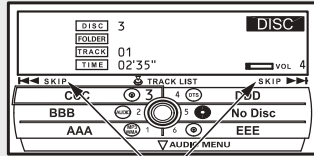

SKIP ICON

You can also change tracks/files on the audio control display. Press the AUDIO button to view the display, then push the selector on the interface dial to the right to skip forward to the beginning of the next track/file. Push the selector left to skip backward to the beginning of the current track/file. Press it again to skip to the beginning of the previous track/file.

In MP3/WMA mode

FOLDER SELECTION – To select a different folder, press and release the ►► side of the TUNE/FOLDER bar to move to the beginning of the next folder. Press and release the ◀◀ side of the bar to move to the beginning of the previous folder.

Using a Track List

You can also select a track/file (in MP3/WMA) directly from the track list on the audio control display. Press the AUDIO button to view the display, then rotate the interface dial to the current disc. Press ENTER on the selector to view the track list on the display. The current disc is highlighted.

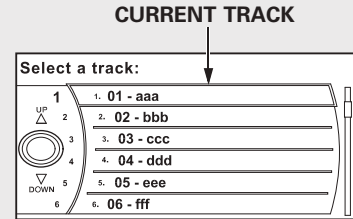

To select a track, rotate the interface dial or push up and down the selector on the interface dial. Then press ENTER on the selector to enter your selection.

CONTINUED

Playing Discs (Models with navigation system)

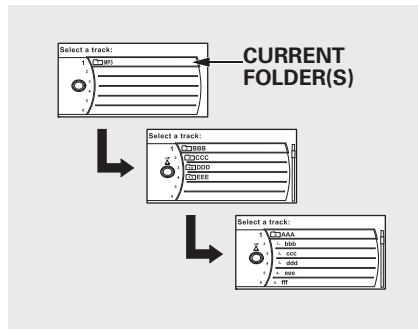

In MP3/WMA mode

You will see a list of the folder(s) on the current disc. To select a folder (s), rotate the interface dial or push up and down the selector on the interface dial. Then press ENTER on the selector to enter your selection. If the disc has several folders, the list advances to the next folder. When the list of the files is displayed, select it by rotating the knob, or pushing the selector up and down.

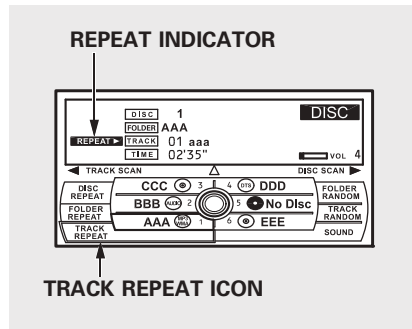

REPEAT – This feature, when activated, continuously replays the current track (file in MP3/WMA mode). To activate it, press the AUDIO button to view the audio control display, then push down the selector on the interface dial. Rotate the interface dial to select track repeat. Press ENTER on the selector to enter your selection.

You will see “REPEAT” next to the TRACK icon on the audio control display. To turn off this feature, select track repeat as previously described, then press ENTER again.

Playing Discs (Models with navigation system)

REPEAT INDICATOR

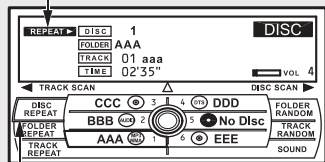

DISC REPEAT ICON

DISC REPEAT – This feature, when activated, continuously replays the current CD. Press the AUDIO button to view the audio control display, then push down the selector on the interface dial. Rotate the interface dial to select the DISC REPEAT. Press ENTER on the selector to enter your selection. You will see “REPEAT” next to the DISC icon on the audio control display. To turn off this feature, select the DISC REPEAT, then press ENTER again.

REPEAT INDICATOR

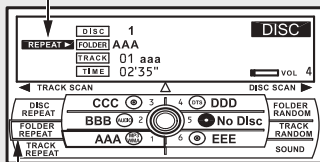

FOLDER REPEAT ICON

In MP3/WMA mode

FOLDER REPEAT – This feature, when activated, replays all the files in the selected folder in the order they are compressed in MP3/WMA. To activate folder repeat, press the AUDIO button to view the audio control display, then push down the selector on the interface dial. Rotate the interface dial to select FOLDER REPEAT. Press ENTER on the selector to enter your selection.

You will see “FOLDER REPEAT” on the audio control display. To turn off this feature, select FOLDER REPEAT, then press ENTER again.

SCAN – The scan function samples all tracks (files in a folder in MP3 or WMA mode) on the disc in the order they are recorded on the disc. To activate scan, press and release the SCAN button. You will also see “SCAN” and the track/file number blinking on the upper display. To hear the rest of the track/file, press and hold the SCAN button for more than 2 seconds. If you don’t, the system advances to the next track/file, plays about 10 seconds of it, and continues through the rest of the track/file the same way. When the system finishes scanning all the tracks/files on the current disc, the system returns to the track/file it first started scanning with, scan is canceled, and the system begins to play that track/file normally.

CONTINUED

Playing Discs (Models with navigation system)

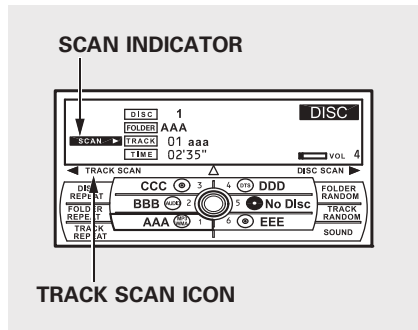

To activate the scan feature on the audio control display, press the AUDIO button to view the display. Push down the selector on the interface dial, then push the selector to the left. You will see “SCAN” next to the TRACK icon on the audio control display. To turn off this feature, push the selector to the left again within 10 seconds.

In MP3/WMA mode

FOLDER SCAN – The folder scan function samples the first file of each folder on the current disc in the order they are compressed in MP3/WMA. To activate this feature, press the SCAN button twice. The first file of each folder plays for about 10 seconds. You will see “FOLDER SCAN” next to disc number on the audio control display. You will also see “SCAN” and the folder number blinking on the upper display. To hear the rest of the file in the folder currently scanning, press and hold the SCAN button for more than 2 seconds.

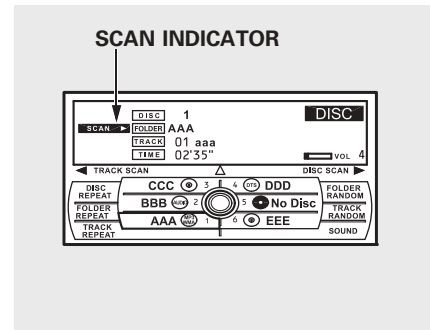

If you don't, the system advances to the next folder, plays about 10 seconds of it, and continues through the rest of the folders the same way.

Playing Discs (Models with navigation system)

DISC SCAN – The disc scan function samples the first track/file (in MP3/WMA mode) on each disc within the changer in numerical order. To activate this feature, press the SCAN button twice. In the MP3/WMA mode, press the SCAN button three times. The first track/file on each disc plays for about 10 seconds. You will see “SCAN” next to the DISC icon on the audio control display. You will also see “SCAN” and the disc number blinking on the upper display. To hear the rest of the track/file on the disc currently scanning, press and hold the SCAN button for more than 2 seconds.

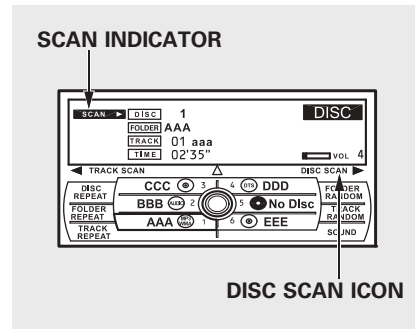

If you don't, the system advances to the next disc, plays about 10 seconds of it, and continues through the rest of the discs the same way.

Each time you press and release the SCAN button, the mode changes from scan, to folder scan, to disc scan, then to normal play.

RANDOM (Random within a disc) – This feature plays the tracks (all files in each folder in MP3/WMA mode) within a disc in random order. To activate random play, press the AUDIO button to view the audio control display, then push down the selector on the interface dial. Rotate the interface dial to select TRACK RANDOM. Press ENTER on the selector to enter your selection.

CONTINUED

Playing Discs (Models with navigation system)

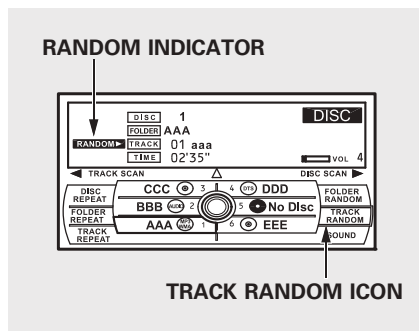

You will see "RANDOM" next to the TRACK/FILE icon on the audio display. To turn off this feature, select TRACK RANDOM, then press ENTER again.

In MP3/WMA mode

FOLDER RANDOM – This feature plays the files within a folder in random order, rather than in the order they are compressed in MP3/WMA. To activate folder random play, press the AUDIO button to view the audio control display, then push down the selector on the interface dial. Rotate the interface dial to select the FOLDER RANDOM. Press ENTER on the selector to enter your selection.

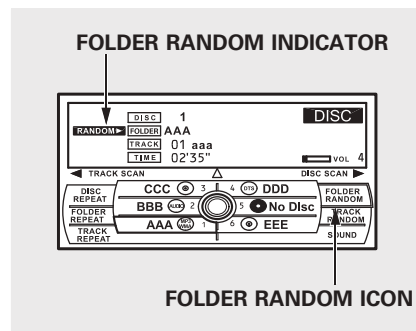

You will see "FOLDER RANDOM" on the audio control display. To turn off this feature, select the FOLDER RANDOM then, press ENTER again.

Playing Discs (Models with navigation system)

Playing a DVD-A Disc

You can play a DVD-A disc in the CD changer. The disc controls are same as previously described.

To Pause a Disc

To pause a disc, press the preset button which corresponds to the current disc. To play the disc again, press the preset button again.

To Stop Playing a Disc

If you turn the system off while a disc is playing, either with the PWR/VOL knob or by turning off the ignition switch, the disc will stay in the drive. When you turn the system back on, the disc will begin playing where it left off.

To take the system out of disc mode, press the AM/FM, or DISC/AUX, or « \times » button to switch to the radio, or satellite radio, or auxiliary input while a disc is playing. When you return to disc mode by pressing the DISC/AUX button, play will continue at the same point that it left off.

Removing Discs from the Changer

To remove the disc that is currently playing, press and release the eject (\blacktriangle) button. You will see “EJECT” on the upper display. When you remove the disc from the slot, the system begins the load sequence so you can load another disc in that position. If you do not load another disc within 10 seconds, the system selects the previous mode (AM, FM1, FM2, or XM Radio).

If you do not remove the disc from the slot, the system will reload the disc after 10 seconds and put the CD changer in pause mode. To begin playing the disc, press the DISC/AUX button.

CONTINUED

Playing Discs (Models with navigation system)

To remove a different disc from the changer, first select it by pressing the corresponding number on the preset button or turning the interface knob, and pressing ENTER on the interface selector. When that disc begins playing, press the eject button.

Press and hold the eject button until you hear a beep to remove all the discs from the changer.

You can also eject discs when the ignition switch is off by pressing the eject button. The disc that was last selected is ejected first. You can eject the rest of the discs one at a time.

Protecting Discs

For information on how to handle and protect compact discs, see page [257](#).

Disc Changer Error Messages

For information, see page [255](#).

Adjusting the Sound

For information, see page [224](#).

Disc Changer Error Messages (Models with navigation system)

If you see an error message in the display while playing a CD, find the cause in the chart to the right. If you cannot clear the error message, take the vehicle to your dealer.

| Error Message | Cause | Solution |
|------------------------|------------------------------|--|
| <i>CHECK DISC</i> | FOCUS Error | Press the EJECT button, and pull out the disc. Check if it is inserted correctly in the disc changer. Make sure the disc is not scratched or damaged. For more information, see page 258. |
| <i>MECH ERROR</i> | Mechanical Error | Press the EJECT button, and pull out the disc. Check the disc for damage or deformation. For more information, see page 258. If the disc cannot be pulled out, or the error message does not disappear after the disc is ejected, see your dealer. |
| <i>HOT</i> | High Temperature | Will disappear when the temperature returns to normal. |
| <i>CHECK DISC LOAD</i> | Check Disc | Press the EJECT button, and pull out the disc. Make sure a playable disc is in the CD changer (see page 241). |
| <i>CHANGER ERROR</i> | Check Disc and Changer Error | Press the EJECT button, and pull out the disc. Check the disc for damage or deformation. For more information, see page 258. If the disc cannot be pulled out, or the error message does not disappear after the disc is ejected, see your dealer. |

CONTINUED

Disc Changer Error Messages (Models with navigation system)

The chart on the right explains the error messages you may see in the display while playing a disc.

If you see an error message in the display while playing a disc, press the eject button. After ejecting the disc, check it for damage or deformation. If there is no damage, insert the disc again.

For the additional information on damaged discs, see page [258](#).

The audio system will try to play the disc. If there is still a problem, the error message will reappear. Press the eject button, and pull out the disc.

Insert a different disc. If the new disc plays, there is a problem with the first disc. If the error message cycle repeats and you cannot clear it, take your vehicle to a dealer.

| Error Message | Cause | Solution |
|---|---------------------------------|--|
| FORMAT | Track/File format not supported | Current track will be skipped. The next supported track or file plays automatically. |
| BAD DISC PLEASE CHECK OWNER'S MANUAL PUSH EJECT | Mechanical error | Press the EJECT button, and pull out the disc(s). Check the disc for serious damage, signs of deformation, excessive scratches, and/or dirt (see page 258 .) |
| BAD DISC PLEASE CHECK OWNER'S MANUAL | Servo error | Insert the disc again. If the code does not disappear, or the disc(s) cannot be removed, consult your dealer. Do not try to force the disc out of the player. |

General Information

- When using CD-R/CD-RW discs, use only high quality CDs labeled for audio use.
- When recording a CD-R/CD-RW, the recording must be closed for it to be used by the system.
- Play only standard round CDs. Odd-shaped CDs may jam in the drive or cause other problems.
- Handle your CDs properly to prevent damage and skipping.

Protecting CDs

When a CD is not being played, store it in its case to protect it from dust and other contamination. To prevent warpage, keep CDs out of direct sunlight and extreme heat.

To clean a CD, use a clean soft cloth. Wipe across the CD from the center to the outside edge.

A new CD may be rough on the inner and outer edges. The small plastic pieces causing this roughness can flake off and fall on the recording surface of the CD, causing skipping or other problems. Remove these pieces by rubbing the inner and outer edges with the side of a pencil or pen.

Never try to insert foreign objects in the disc changer.

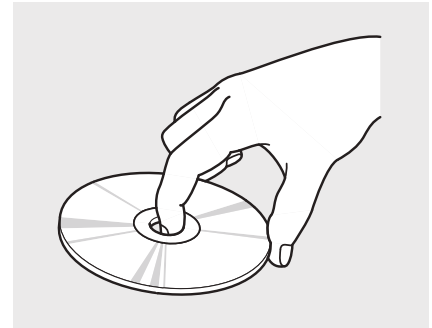

Handle a CD by its edges; never touch either surface. Do not place stabilizer rings or labels on the CD. These, along with contamination from fingerprints, liquids, and felt-tip pens, can cause the CD to not play properly or possibly jam in the drive.

CONTINUED

Protecting Your Discs

Additional Information on Recommended Discs

The in-dash disc player/changer has a sophisticated and delicate mechanism. If you insert a damaged disc as indicated in this section, it may become stuck inside and damage the audio unit.

Examples of these discs are shown to the right:

1. Bubbled, wrinkled, labeled, and excessively thick discs

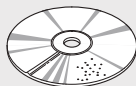

**Bubbled/
Wrinkled**

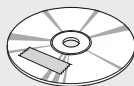

**With Label/
Sticker**



**Using Printer
Label Kit**

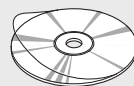

Sealed

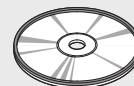

**With Plastic
Ring**

2. Damaged discs

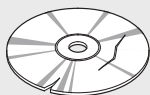

**Chipped/
Cracked**

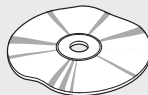

Warped

3. Poor quality discs

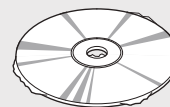

Burrs

4. Small, irregular shaped discs



3-inch (8-cm) CD

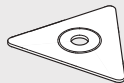

Triangle Shape

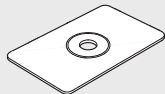

Can Shape

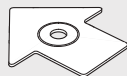

Arrow Shape

5. Discs with scratches, dirty discs

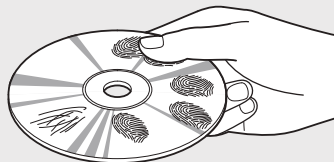

Fingerprints, scratches, etc.

- CD-R or CD-RW may not play due to the recording conditions.
- Scratches and fingerprints on the discs may cause the sound to skip.

- Recommended discs are printed with the following logo.



- Audio unit may not play the following formats.



Playing an iPod (Models with navigation system)

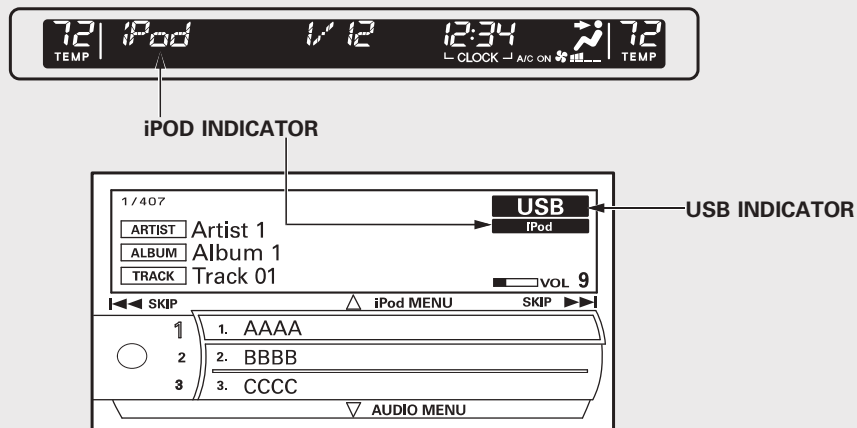

U.S. model is shown.

Playing an iPod (Models with navigation system)

U.S. model is shown.

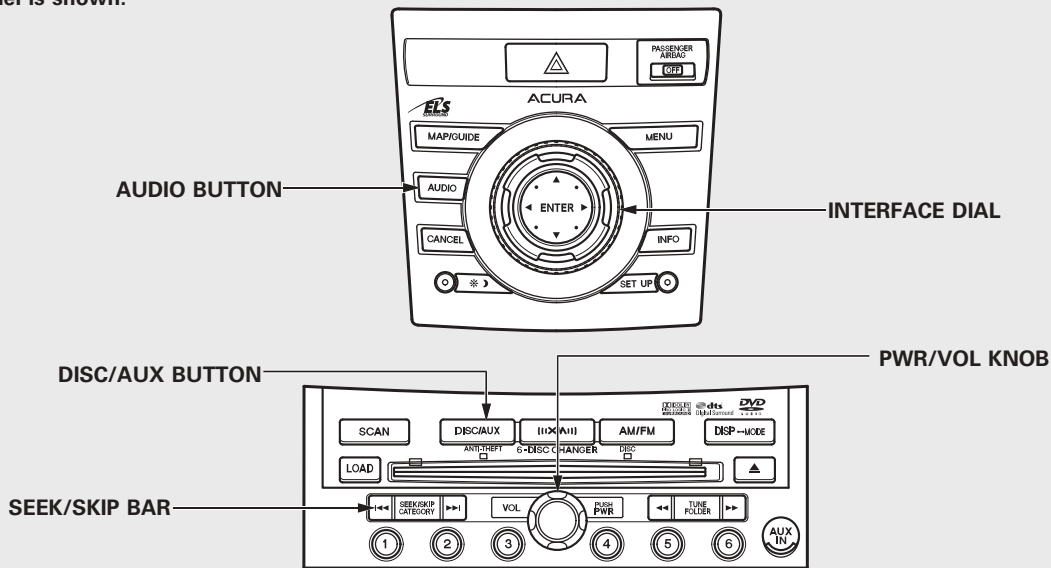

CONTINUED

Playing an iPod (Models with navigation system)

To Play an iPod®

This audio system can operate the audio files on the iPod® with the same controls used for the in-dash disc changer. To play an iPod, connect it to the USB adapter cable in the console compartment by using your dock connector, then press the DISC/AUX button. The ignition switch must be in the ACCESSORY (I) or ON (II) position. The iPod will also be recharged with the ignition switch in these positions.

The system will only play songs stored on the iPod with iTunes.

iPod and iTunes are registered trademarks owned by Apple Inc.

Voice Control System

You can select the AUX mode by using the navigation system voice control buttons, but cannot operate the play mode functions.

iPods compatible with your audio system using the USB adapter cable are:

| Model | Software |
|---------------------------------------|--------------------|
| iPod classic | Ver. 1.0 or more |
| iPod with video (iPod 5th generation) | Ver. 1.2 or more |
| iPod nano | Ver. 1.2 or more |
| iPod nano 2nd generation | Ver. 1.1.2 or more |
| iPod nano 3rd generation | Ver. 1.0 or more |
| iPod nano 4th generation | Ver. 1.0.2 or more |
| iPod touch | Ver. 1.1.1 or more |
| iPod touch 2nd generation | Ver. 2.1.1 or more |

Use only compatible iPods with the latest software. iPods that are not compatible will not work in this audio unit.

NOTE:

- Do not connect your iPod using a hub.
- Do not keep the iPod in the vehicle. Direct sunlight and high heat will damage it.
- Do not use an extension cable between the USB adapter cable equipped with your vehicle and your dock connector.
- We recommend backing up your data before playing it.
- Some devices cannot be powered or charged via the USB adapter, if this is the case use the accessory adapter to supply power to your device.

Playing an iPod (Models with navigation system)

Connecting an iPod

USB ADAPTER CABLE

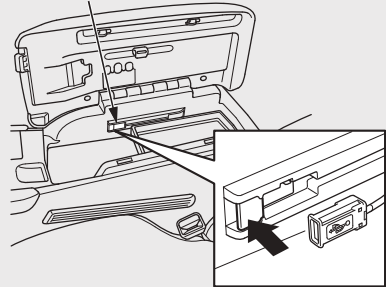

1. Push the release button to release the USB adapter cable.

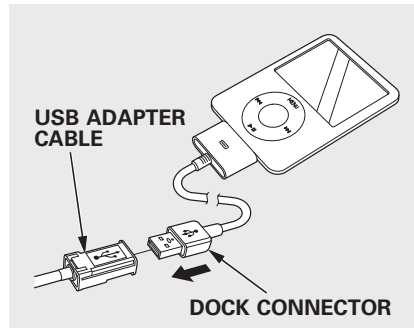

2. Connect your dock connector to the iPod correctly and securely.
3. Install the dock connector to the USB adapter cable securely.

If the iPod indicator does not appear in the audio display, check the connections, and try to reconnect the iPod a few times.

If the audio system still does not recognize the iPod, the iPod may need to be reset. Follow the instructions that came with your iPod, or you can find reset instructions online at www.apple.com/ipod.

The current file number and total of the selected playable files are displayed in the upper display. Pressing the AUDIO button displays the artist, album and track (file) names on the navigation screen.

CONTINUED

Playing an iPod (Models with navigation system)

To Change or Select Files

Use the SKIP bar while an iPod is playing to select passages and change files.

SKIP – Each time you press and release the ►► side of the SEEK/SKIP bar, the system skips forward to the beginning of the next file. Press and release the ◄◄ side of the bar, to skip backward to the beginning of the current file. Press it again to skip to the beginning of the previous file.

To move rapidly within a file, press and hold either side (►► or ◄◄) of the SEEK/SKIP bar.

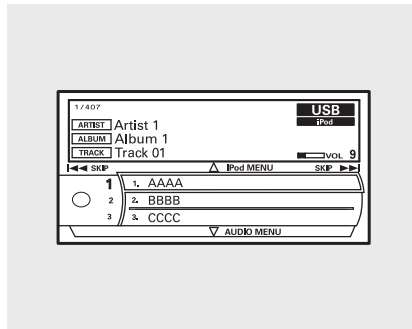

You can also change files with the interface dial. Press the AUDIO button to show the audio control display. Push the selector to the right side to skip forward and to the left side to skip backward.

To Select a File from iPod Menu

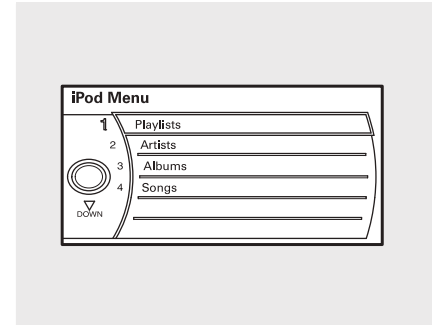

You can also select a file from any list on the iPod menu: playlists, artists, albums and songs, by using the interface dial. Press the AUDIO button to display the audio control display. Push up the interface selector to display the iPod menu. Turn the knob on the interface dial to select a desired list.

Playing an iPod (Models with navigation system)

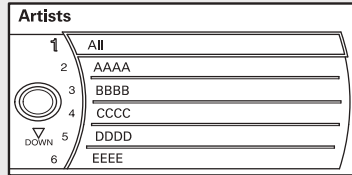

Push ENTER on the selector to display the items on that list, then turn the knob on the interface dial to select a desired list. Pushing the selector up or down moves a selection to the top or bottom of the screen items. Press ENTER to set your selection.

If you select “ALL” on either the artists or albums list, all available files on the selected list are played.

Press the AUDIO button to go back to the normal audio playing display. Pressing the CANCEL button goes back to the previous screen, and pressing the MAP button cancels the audio control display.

To Select Repeat or Random Mode:

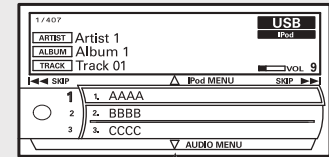

Push down the selector.

You can select any type of repeat and random mode on the audio menu. Press the AUDIO button to display the audio control display, then push down the selector to display the audio menu. Turn the knob on the interface dial to select an audio mode: repeat, album random, and track random. Press ENTER to set your selection.

CONTINUED

Playing an iPod (Models with navigation system)

To cancel the selected mode, press ENTER again while the highlighted mode is selected on the audio control display.

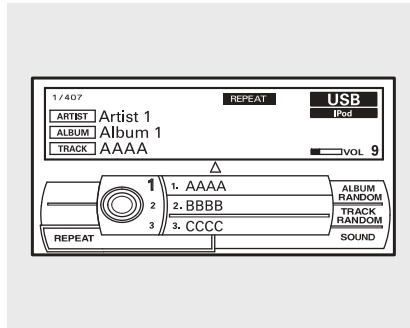

REPEAT – This feature continuously plays a file. To turn it off, press ENTER again.

Pressing either side of the SKIP bar changes the file while keeping the repeat feature.

TRACK RANDOM – This feature plays all available files from the selected items in the iPod menu list (playlists, artists, albums or songs) in random order. You will see TRACK RANDOM on the screen.

To turn it off, have this mode highlighted and press ENTER again.

Playing an iPod (Models with navigation system)

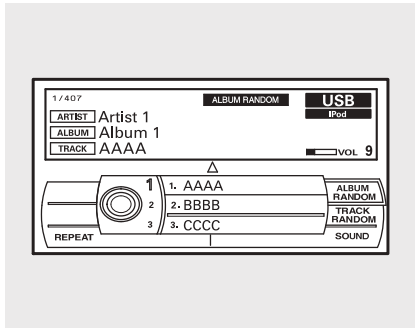

ALBUM RANDOM – This feature plays all available albums from the selected items in the iPod menu list (playlists, artists, albums or songs) in random order. The files in each album are played in the recorded order. You will see ALBUM RANDOM on the screen.

To turn it off, have this mode highlighted and press ENTER again.

You can also select another list from the iPod menu while keeping the random function.

NOTE:

Available operating function varies on models or versions. Some functions may not be available on the vehicle's audio system.

To Stop Playing Your iPod

To play the radio, press the AM, FM, or (« \times »») button. Press the DISC/AUX button to switch between disc (if a disc is loaded), *Bluetooth*[®] Audio, and the iPod.

CONTINUED

Playing an iPod (Models with navigation system)

Disconnecting an iPod

You can disconnect the iPod at any time when you see the “OK to disconnect” message* in the iPod display. Always make sure you see the “OK to disconnect” message in the iPod display before you disconnect it. Make sure to follow the iPod's instructions on how to disconnect the dock connector from the USB adapter cable.

*: The displayed message may vary on models or versions. On some models, there is no message to disconnect.

When you disconnect the iPod while it is playing, the upper display and the audio control display (if selected) show NO DATA.

If you reconnect the same iPod, the system may begin playing where it left off, depending on what mode the iPod is in when it is reconnected.

iPod Error Messages

For information, see page [269](#).

iPod Error Messages (Models with navigation system)

If you see an error message on the upper display while playing an iPod, find the solution in the chart to the right. If you cannot clear the error message, take your vehicle to your dealer.

| Error Message | Cause | Solution |
|--|-----------------------------|--|
| USB ERROR | USB ROM error | There is a problem with the USB adapter unit. |
| BAD USB DEVICE PLEASE CHECK OWNERS MANUAL | Abnormal power source | Appears when the overcurrent protection feature of the system stops supplying power to USB because an incompatible device is connected. Disconnect the device. Then, turn the audio system off, and turn it on again. Do not reconnect the device that caused the error. |
| NO SONG | No files in iPod | Appears when the iPod is empty. Store some files in the iPod. |
| UNSUPPORTED | Use of unsupported device | Appears when an unsupported device is connected. Disconnect the device. |
| UNSUPPORTED VER. | Use of unsupported iPod | Appears when an unsupported iPod is connected. See page 262 for specification information on iPods. If it appears when a supported iPod is connected, update the iPod software to the newer version. |
| CONNECT RETRY | Recognition failure of iPod | Appears when the system does not acknowledge the iPod. Reconnect the iPod. |

Playing a USB Flash Memory Device (Models with navigation system)



USB INDICATOR

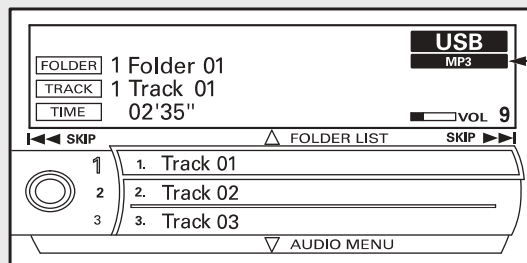

FILE TYPE

U.S. model is shown.

Playing a USB Flash Memory Device (Models with navigation system)

U.S. model is shown.

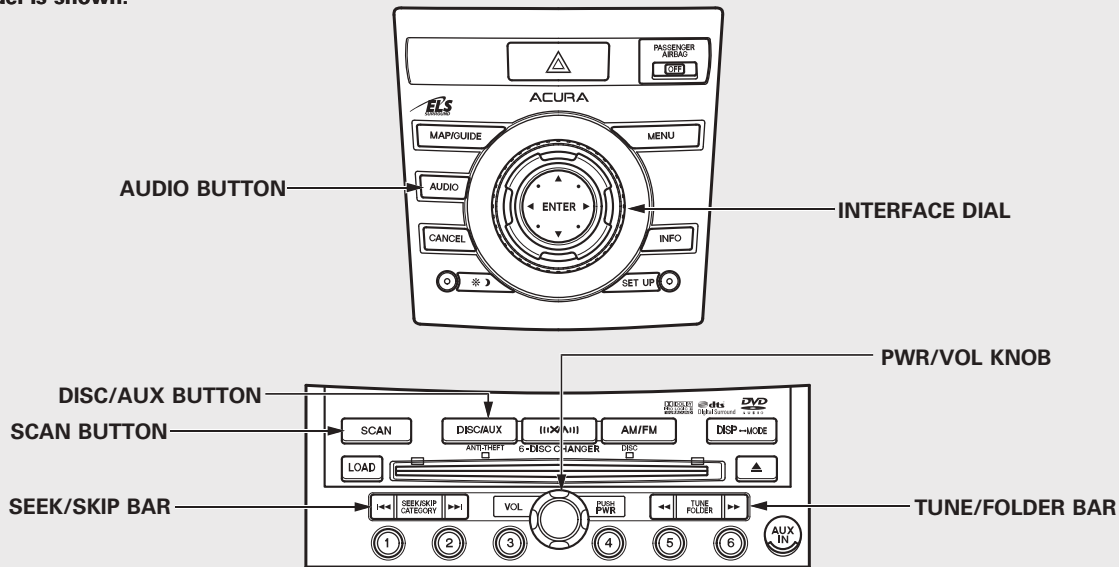

CONTINUED

Playing a USB Flash Memory Device (Models with navigation system)

To Play a USB Flash Memory Device

This audio system can operate the audio files on a USB flash memory device with the same controls used for the in-dash disc changer. To play a USB flash memory device, connect it to the USB adapter cable in the console compartment, then press the DISC/AUX button. The ignition switch must be in the ACCESSORY (I) or ON (II) position.

The audio system reads and plays the audio files on the USB flash memory device in MP3, WMA or AAC* formats. Depending on the format, the audio control display shows MP3, WMA or AAC when a USB flash memory device is playing. The USB flash memory device limit is up to 700 folders or up to 65535 files.

*: Only AAC format files recorded with iTunes are playable on this audio unit.

The recommended USB flash memory devices are 256 MB or higher, and formatted with the FAT file system. Some digital audio players may be compatible as well.

Some USB flash memory devices (such as devices with security lock-out features, etc.) will not work in this audio unit.

NOTE:

- Do not use a device such as a card reader or hard drive as the device or your files may be damaged.
- Do not connect your USB flash memory device using a hub.
- Do not use an extension cable to the USB adapter cable equipped with your vehicle.
- Do not keep a USB flash memory device in the vehicle. Direct sunlight and high heat will damage it.

- We recommend backing up your data before playing a USB flash memory device.
- Depending on the type and number of files, it may take some time before they begin to play.
- Depending on the software the files were made with, it may not be possible to play some files, or display some text data.
- Some devices cannot be powered or charged via the USB adapter, if this is the case use the accessory adapter to supply power to your device.

Voice Control System

You can select the AUX mode by using the navigation system voice control buttons, but cannot operate the play mode functions.

Playing a USB Flash Memory Device (Models with navigation system)

The specifications for compatible MP3 files are:

- Sampling frequency:
32/44.1/48 kHz (MPEG1)
16/22.05/24 kHz (MPEG2)
- Bitrate:
32/40/48/56/64/80/96/112/128/
160/192/224/256/320/VBR kbps
(MPEG1)
- Supported standards:
MPEG1 Audio Layer3
MPEG2 Audio Layer3
- Partition:
Top partition only
- Maximum layers: 8

The specifications for compatible WMA files are:

- Sampling frequency:
32/44.1/48 kHz
- Bitrate:
48 – 320/VBR kbps (Max 384)
- Supported standards:
WMA version 7/8/9
- Partition:
Top partition only
- Maximum layers: 8

The specifications for compatible AAC files are:

- Sampling frequency:
8/11.025/12/16/22.05/24/32/
44.1/48 kHz
- Bitrate:
48 – 320 kbps
- Supported standards:
MPEG4/AAC LC
MPEG2/AAC LC
- Partition:
Top partition only
- Maximum layers: 8

Even if recorded in MP3, WMA or AAC format, unsupported files cannot be played. If the system finds it, the audio unit displays UNPLAYABLE, and then skips to the next file.

CONTINUED

Playing a USB Flash Memory Device (Models with navigation system)

Connecting a USB Flash Memory Device

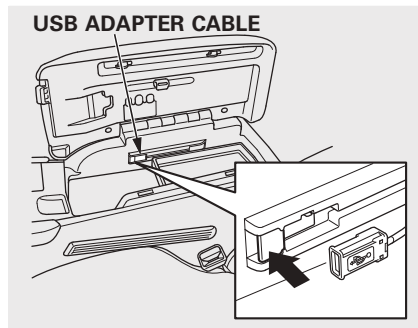

1. Push the release button to release the USB adapter cable.

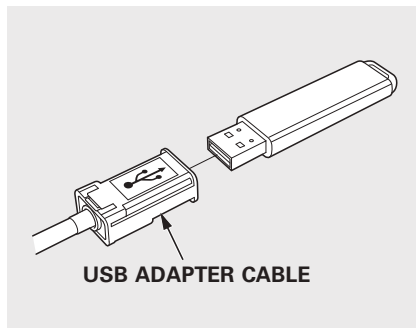

2. Connect the USB flash memory device to the USB adapter cable correctly and securely.

When the USB device is connected and the USB mode is selected on the audio system, the USB indicator is shown in the upper display. Pressing the AUDIO button to displays the folder and file names, and the elapsed time in the audio control display.

To Change or Select Files

Use the SKIP bar while a USB flash memory device is playing to select passages and change files.

SKIP – Each time you press and release the side of the SKIP bar, the system skips forward to the beginning of the next file. Press and release the side of the bar, to skip backward to the beginning of the current file. Press it again to skip to the beginning of the previous file.

To move rapidly within a file, press and hold either side (▶▶ or ◀◀) of the SKIP bar.

Playing a USB Flash Memory Device (Models with navigation system)

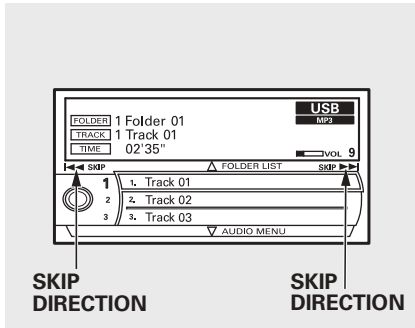

You can also change files with the interface dial. Press the AUDIO button to show the audio control display. Push the selector knob to the right side to skip to the beginning of the next file, and to the left side to skip to the beginning of the current file. Pushing it to the left again skips to the beginning of the previous file.

FOLDER SELECTION – To select a different folder, press and release the ►► side of the TUNE/FOLDER bar to move to the beginning of the next folder. Press and release the ◀◀ side of the bar to move to the beginning of the previous folder.

To Select a File from Folder and File Lists

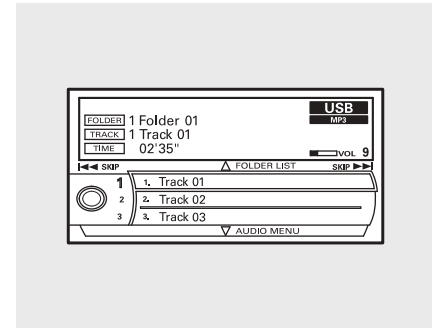

You can also select a folder or file from the list by using the interface dial. Press the AUDIO button to show the audio control display.

CONTINUED

Playing a USB Flash Memory Device (Models with navigation system)

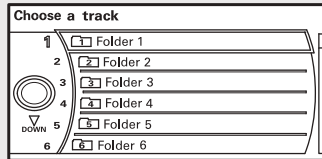

Push up the selector on the interface dial to switch the display to the folder list, then turn the knob on the interface dial to select a folder.

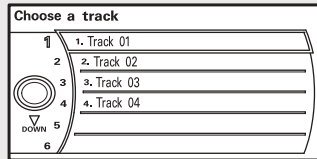

Press ENTER to change the display to the file list, then turn the knob on the interface dial to select a file. Press ENTER to set your selection.

To go back to the normal play display, press the AUDIO button. Pressing the CANCEL button goes back to the previous screen and pressing the MAP button cancels the audio control display.

To Select Repeat, Random or Scan Mode:

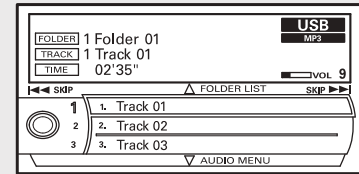

You can select any type of repeat, random and scan modes on the audio menu screen. Press the AUDIO button to show the audio control display. Push down the selector on the interface dial to display the audio menu items.

Playing a USB Flash Memory Device (Models with navigation system)

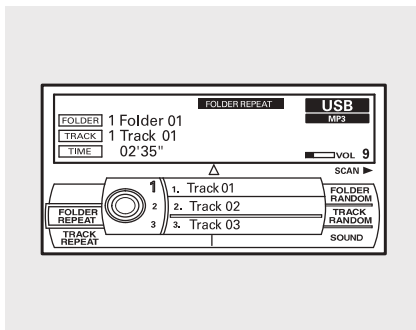

Turn the knob on the interface dial to select a play mode: folder random, track random, folder repeat, track repeat. Press ENTER to set your selection.

To cancel the selected mode, push down the selector to display the audio menu on the audio control display. Turn the knob on the interface dial to select the highlighted play mode, then press ENTER to turn off that selected mode.

FOLDER REPEAT – This feature replays all the files in the selected folder in the order they are stored. Pressing either side of the CATEGORY bar also turns off this feature.

TRACK REPEAT – This feature continuously plays a file. Pressing either side of the SKIP bar also turns off this feature.

FOLDER RANDOM – This feature plays the files in the selected folder in random order.

TRACK RANDOM – This feature plays all the files in random order.

TRACK SCAN – This function samples all files in the selected folder in the order they are stored. To activate the scan feature, push the selector to the right. You will see TRACK SCAN on the screen. You will also see SCAN on the upper display and the file number blinking. You will get a 10 second sampling of each file in the folder. Push the selector repeatedly to get out of the scan mode. The system plays the last file sampled.

You can also select the scan feature with the SCAN button on the control panel. Press and release the SCAN button. Press and hold the SCAN button to get out of the scan mode and play the last file sampled.

CONTINUED

Playing a USB Flash Memory Device (Models with navigation system)

FOLDER SCAN – This function samples the first file in each folder in the order they are stored. To activate the folder scan feature, push the selector to the right repeatedly. You will see FOLDER SCAN on the screen. You will also see SCAN on the upper display and the folder number blinking. You will get a 10 second sampling of the first file in each folder. Push the selector repeatedly to get out of the scan mode. The system plays the last file sampled.

You can also select the folder scan feature with the SCAN button on the control panel. Press and release the SCAN button repeatedly. Press and hold the SCAN button to get out of the folder scan mode and play the last file sampled.

To Stop Playing a USB Flash Memory Device

To play the radio, press the AM/FM or («»/«») button. Press the DISC/AUX button to switch to the disc mode (if a disc is loaded). Press the DISC/AUX button to switch the audio mode between the USB mode and *Bluetooth*® Audio.

If you reconnect the same USB flash memory device, the system will begin playing where it left off.

USB Flash Memory Device Error Messages

For information, see page [279](#).

Disconnecting a USB Flash Memory Device

You can disconnect the USB flash memory device at any time even if the USB mode is selected on the audio system. Always follow the USB flash memory device's instructions when you remove it.

When you disconnect the USB flash memory device while it is playing, the upper display and the audio control display (if selected) show NO DATA.

USB Flash Memory Device Error Messages (Models with navigation system)

If you see an error message on the upper display while playing a USB flash memory device, find the solution in the chart to the right. If you cannot clear the error message, take your vehicle to your dealer.

| Error Message | Cause | Solution |
|--|--|--|
| USB ERROR | USB ROM error | There is a problem with the USB adapter unit. |
| BAD USB DEVICE PLEASE CHECK OWNERS MANUAL | Abnormal power source | Appears when the overcurrent protection feature of the system stops supplying power to USB because an incompatible device is connected. Disconnect the device. Then, turn the audio system off, and turn it on again. Do not reconnect the device that caused the error. |
| UNPLAYABLE FILE | Use of unsupported files | Appears when the files in the USB flash memory device are DRM or an unsupported format. This error message appears for a few seconds, then plays the next song. |
| USB NO SONG | No files in USB flash memory device | Appears when the USB flash memory device is empty or there are no MP3, WMA, or AAC files in the USB flash memory device. Save some MP3, WMA, or AAC files in the USB flash memory device. |
| UNSUPPORTED | Use of unsupported USB flash memory device | Appears when an unsupported device is connected. See page 273 for specification information on USB flash memory devices. If it appears when the supported device is connected, reconnect the device. |

Bluetooth® Audio System (Models with navigation system)

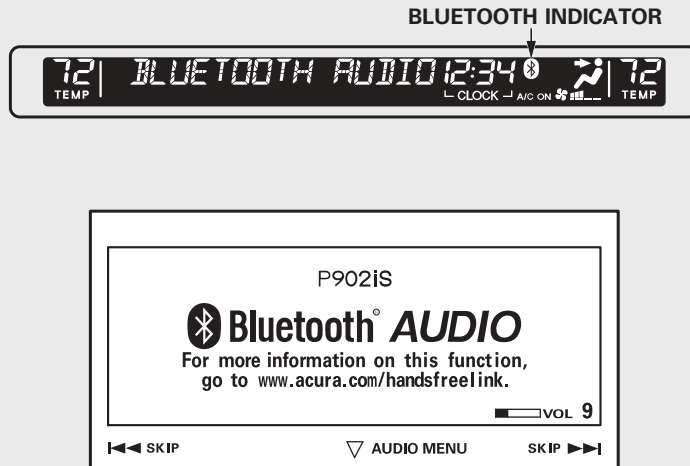

U.S. model is shown.

Bluetooth® Audio System (Models with navigation system)

U.S. model is shown.

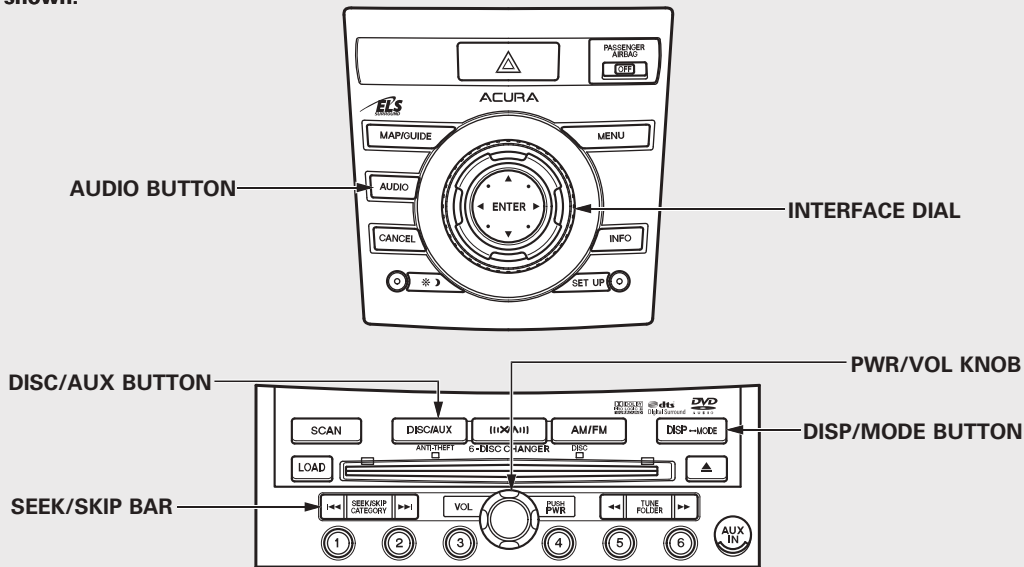

CONTINUED

Bluetooth® Audio System (Models with navigation system)

Your vehicle is equipped with a *Bluetooth®* Audio system, which allows you to listen to streaming audio from your *Bluetooth®* Audio compatible phone. This function is only available on *Bluetooth®* Audio Compatible phones that are paired and linked to the vehicle's *Bluetooth®* HandsFreeLink® (HFL) system (see page 313).

Not all Bluetooth-enabled phones with streaming audio capabilities are compatible with the system. You can find an approved phone by visiting www.acura.com/handsfreelink, or by calling the HandsFreeLink® consumer support at 1-888-528-7876. In Canada, visit www.acura.ca, or call 1-888-9-ACURA-9.

NOTE: In some states, it may be illegal to perform some data device functions while driving.

To Play *Bluetooth®* Audio Files



Make sure that your phone is paired and linked to the HFL.

Press the DISC/AUX button* with the ignition switch in the ACCESSORY (I) or ON (II) position. When the phone is recognized, you will see the *Bluetooth®* Audio message and indicator on the upper display and the audio control display (if selected), and the system begins to play.

***Bluetooth*[®] Audio System (Models with navigation system)**

Once a device is linked, the name of the device will appear on the screen. Pressing the DISP/MODE button switches the audio control display between the *Bluetooth*[®] Audio and the device name.

If more than one phone is paired to the HFL system, there will be a delay before the system begins to play.

To play the audio files, you may need to operate your phone. If so, follow the phone maker's operating instructions.

*: If an iPod, USB flash memory device or audio unit connected to the auxiliary input jack was selected at the last mode, you will see iPod, USB or AUX in the upper display and the audio control display (if selected). Push the DISC/AUX button again to play audio files from your *Bluetooth*[®] Audio phone.

In the following conditions, the display shows "NO CONNECT" message.

- The phone is not linked to HFL.
- The phone is not turned on.
- The phone is not in the vehicle.
- Another HFL compatible phone, which is not compatible for *Bluetooth*[®] Audio, is already connected.

If your *Bluetooth*[®] Audio compatible phone does not operate as described, make sure it is an Acura approved phone. To find out if your phone is approved, go to www.acura.com/handsfreelink (in Canada, www.acura.ca), or call the HandsFreeLink[®] consumer support at (888) 528-7876.

Voice Control System

You can select the AUX mode by using the navigation system voice control buttons, but cannot operate the play mode functions.

CONTINUED

Bluetooth® Audio System (Models with navigation system)

To skip a file

Press the ►► side of the SKIP bar to skip forward to the next file, and press the ◀◀ side to skip backward to the beginning of the current file. Push the ◀◀ side again to skip to the previous file.

You can also operate the skip function with the interface dial on the audio control display of the navigation screen. Push the AUDIO button. Each time you push the selector on the interface dial to the right, the system skips forward to the beginning of the next file. Push it to the left to skip backward to the beginning of the current file. Push the selector to the left again to skip to the previous file.

To pause or resume a file



The resume/pause mode can stop playing a file temporarily. Push down the selector on the interface dial to display the audio menu.

Turn the knob on the interface dial to switch the setting between the resume/pause mode and the sound mode. Select RESUME/PAUSE, then press ENTER to set your selection. Each time you press ENTER, the system switches between the resume mode and pause mode.

NOTE: The pause function may not be available on some phone devices.

Bluetooth® Audio System (Models with navigation system)

To change sound settings

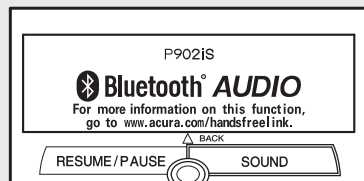

Press the AUDIO button, then push down the selector to display the audio menu. Turn the knob to switch the setting between the resume/pause mode and the sound mode. Select SOUND, then press ENTER to set your selection.

Turn the knob to select a sound mode, then press ENTER to set your selection. Turn the knob to your liking (see page 224 for more sound setting information).

To switch to HFL mode

If you receive a call when the Bluetooth® Audio is playing, press the HFL Talk button on the steering wheel. The audio control display and the upper display switch to the HFL mode (see page 309).

After ending the call, press the HFL Back button to go back to the Bluetooth® Audio mode.

If you receive a call while the system is in the pause mode, the mode will be canceled and Bluetooth® Audio will continue to play.

To turn off the Bluetooth® Audio mode

Select any other audio mode by pressing a button; AM/FM, XM or DISC/AUX (if a disc is loaded), on the audio control panel or press the mode button on the steering wheel repeatedly to select another audio mode. If an iPod or USB flash memory device is connected to the USB adapter cable or audio unit is connected to AUX jack, pressing the DISC/AUX button also changes a mode.

Switching to another mode pauses the music playing from your phone.

CONTINUED

Bluetooth® Audio System (Models with navigation system)

As required by the FCC:

This device complies with Part 15 of the FCC rules. Operation is subject to the following two conditions: (1) This device may not cause harmful interference, and (2) this device must accept any interference received, including interference that may cause undesired operation.

Changes or modifications not expressly approved by the party responsible for compliance could void the user's authority to operate the equipment.

This device complies with Industry Canada Standard RSS-210.

Operation is subject to the following two conditions: (1) this device may not cause interference, and (2) this device must accept any interference that may cause undesired operation of the device.

FM/AM Radio Frequencies

The radio can receive the complete AM and FM bands.

Those bands cover these frequencies:

AM band: 530 to 1,710 kHz

FM band: 87.7 to 107.9 MHz

Radio stations on the AM band are assigned frequencies at least 10 kHz apart (530, 540, 550). Stations on the FM band are assigned frequencies at least 0.2 MHz apart (87.9, 88.1, 88.3).

Stations must use these exact frequencies. It is fairly common for stations to round-off the frequency in their advertising, so your radio could display a frequency of 100.9 even though the announcer may identify the station as "FM101."

FM/AM Radio Reception

How well the radio receives stations is dependent on many factors, such as the distance from the station's transmitter, nearby large objects, and atmospheric conditions.

A radio station's signal gets weaker as you get farther away from its transmitter. If you are listening to an AM station, you will notice the sound volume becoming weaker, and the station drifting in and out. If you are listening to an FM station, you will see the stereo indicator flickering off and on as the signal weakens. Eventually, the stereo indicator will go off and the sound will fade completely as you get out of range of the station's signal.

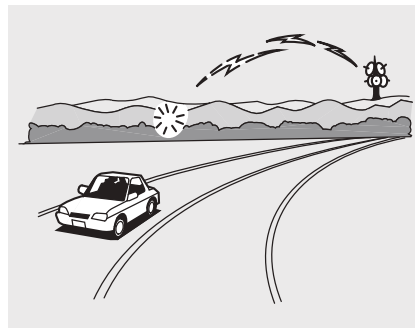

Driving very near the transmitter of a station that is broadcasting on a frequency close to the frequency of the station you are listening to can also affect your radio's reception. You may temporarily hear both stations, or hear only the station you are close to.

CONTINUED

FM/AM Radio Reception

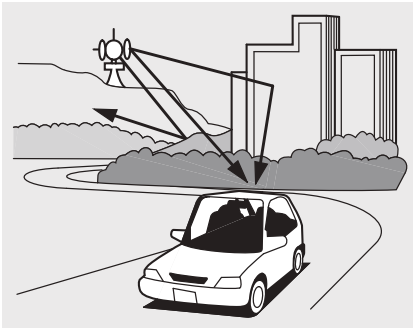

Radio signals, especially on the FM band, are deflected by large objects such as buildings and hills. Your radio then receives both the direct signal from the station's transmitter, and the deflected signal. This causes the sound to distort or flutter. This is a main cause of poor radio reception in city driving.



Radio reception can be affected by atmospheric conditions such as thunderstorms, high humidity, and even sunspots. You may be able to receive a distant radio station one day and not receive it the next day because of a change in conditions.

Electrical interference from passing vehicles and stationary sources can cause temporary reception problems.

*As required by the FCC:
Changes or modifications not expressly
approved by the party responsible for
compliance could void the user's
authority to operate the equipment.*

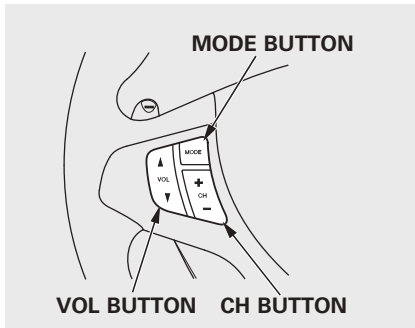

Three controls for the audio system are mounted in the steering wheel hub. They let you control basic functions without removing your hand from the steering wheel.

The VOL button adjusts the volume up (▲) or down (▼). Press the top or bottom of the button, hold it until the desired volume is reached, then release it.

The MODE button changes the mode. *On vehicles without navigation system* Pressing the MODE button repeatedly cycles through all possible media sources whether they are present or not. *On vehicles with navigation system* Pressing the MODE button repeatedly cycles through all present, connected media sources. Media sources that are not present or connected will not appear when cycling with the MODE button.

If you are listening to the radio, use the CH button to change stations. Each time you press and release the top (+) of the button, the system goes to the next preset station on the band you are listening to. Press and release the bottom (-) to go back to the previous station.

To activate the seek function, press and hold the top (+) or bottom (-) of the CH button until you hear a beep. The system searches up or down from the current frequency to find a station with a strong signal.

CONTINUED

Remote Audio Controls

If you are playing a disc, the system skips to the beginning of the next track (file in MP3 or WMA format) each time you press the top (+) of the CH button. Press the bottom (-) to return to the beginning of the current track/file. Press it twice to return to the previous track/file.

To select a different disc (folder in MP3/WMA mode), press and hold the top (+) or bottom (-) of the CH button until you hear a beep.

If you are listening to XM Radio, use the CH button to change channels. Each time you press the top (+) of the button, the system goes to the next preset channel. Press the bottom (-) to go back to the previous preset channel.

To go to the next channel of the category you are listening to, press and hold the top (+) or bottom (-) of the CH button until you hear a beep.

If you are playing a USB flash memory device or iPod with the USB adapter cable, press and release the top (+) of the CH button to skip forward to the beginning of the next file. Press the bottom (-) to skip backward to the beginning of the current file. Press it twice to return to the previous file.

When playing a USB flash memory device, you can also use the seek function to skip the folder. To activate this, press and hold either side of the CH button until you hear a beep.

Auxiliary Input Jack

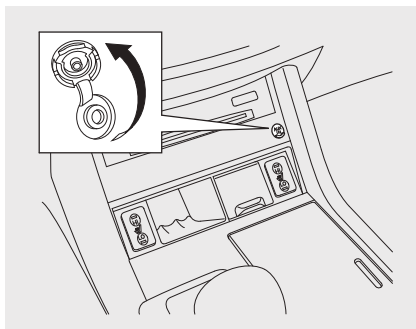

The auxiliary input jack is on the disc changer unit. The system will accept auxiliary input from standard audio accessories.

When the audio system is on and you plug in a mini-jack cable between a compatible audio unit and the jack, you will see AUX in the display and the system automatically switches to AUX mode.

Radio Theft Protection

Your vehicle's audio system will disable itself if it is disconnected from electrical power for any reason. To make it work again, you must enter a specific five-digit code with the preset bars or buttons (depending on models). Because there are hundreds of number combinations possible from the five digits, making the system work without knowing the exact code is nearly impossible.

You should have received a card that lists your audio system code number and serial number. It is best to store this card in a safe place at home. In addition, you should write the audio system's serial number in this owner's manual.

If you lose the card, you must obtain the code number from your dealer. To do this, you will need the audio system's serial number.

NOTE:

If you have a My Acura account, you can retrieve the anti-theft code online.

If your vehicle's battery is disconnected or goes dead, the audio system will disable itself. If this happens, you will see “ENTER CODE” on the center or upper display (depending on models) the next time you turn on the system. Use the preset bars or buttons (depending on models) to enter the five-digit code. The code is located on the radio code card included in your owner's manual kit. When it is entered correctly, the radio will start playing.

If you make a mistake entering the code, do not start over; complete the five-digit sequence, then enter the correct code. You have ten tries to enter the correct code. If you are unsuccessful in ten attempts, you must then leave the system on for 1 hour before trying again.

The system will retain your AM and FM presets even if power is disconnected.

Setting the Clock

On models without navigation system

To set the time, press the SOUND/CLOCK button until you hear a beep, then release the button. The displayed time begins to blink.

Change the hour by pressing the H (preset 4) side of the preset bar until the numbers advance to the desired time. Change the minute by pressing the M (preset 5) side of the bar until the numbers advance to the desired time.

You can quickly set the time to the nearest hour. If the displayed time is before the half hour, pressing the SOUND/CLOCK button until you hear a beep, then pressing the R (preset 6) side of the preset bar sets the clock back to the previous hour. If the displayed time is after the half hour, the clock sets forward to the beginning of the next hour.



U.S. model is shown.

When you are finished, press the SOUND/CLOCK button again to set the time.

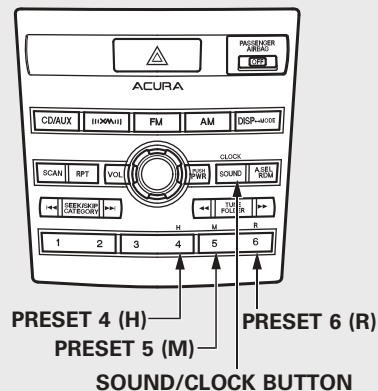

On models with navigation system
The navigation system receives signals from the global positioning system (GPS), and the displayed time is updated automatically by the GPS. Refer to the navigation system manual for how to adjust the time.

Security System

The security system helps to protect your vehicle and valuables from theft. The horn sounds and a combination of headlights, parking lights, side marker lights, and taillights flashes if someone attempts to break into your vehicle or remove the radio. This alarm continues for 2 minutes, then the system resets. To reset an alarming system before the 2 minutes have elapsed, unlock the driver's door with the key or the remote transmitter.

The security system automatically sets 15 seconds after you lock the doors, hood, and the tailgate. For the system to activate, you must lock the doors and the tailgate from the outside with the key, driver's lock tab, door lock master switch, or remote transmitter. The security system indicator on the instrument panel starts blinking immediately to show you the system is setting itself.



Once the security system is set, opening any door, the tailgate, or the hood without using the key or the remote transmitter, will cause the alarm to activate. It will also activate if the audio unit is removed from the dashboard or the wiring is cut.

The alarm will also be activated if a passenger inside the locked vehicle turns the ignition switch on.

The security system will not set if the hood, tailgate, or any door is not fully closed. Before you leave the vehicle, make sure the doors, tailgate, and hood are securely closed.

NOTE: To see if the system is set after you exit the vehicle, press the LOCK button on the remote transmitter within 5 seconds. If the system is set, a beep will sound.

Do not attempt to alter this system or add other devices to it.

Compass Operation

On models without navigation system

The compass shows your direction of travel. It indicates eight directions.

The compass is displayed on the center display when you turn the ignition switch to the ON (II) position.

The compass can be affected by driving near power lines or stations, across bridges, through tunnels, over railroad crossings, past large vehicles, or driving near large objects that cause magnetic interference. It can also be affected by accessories such as antennas and roof racks that are mounted by magnets.

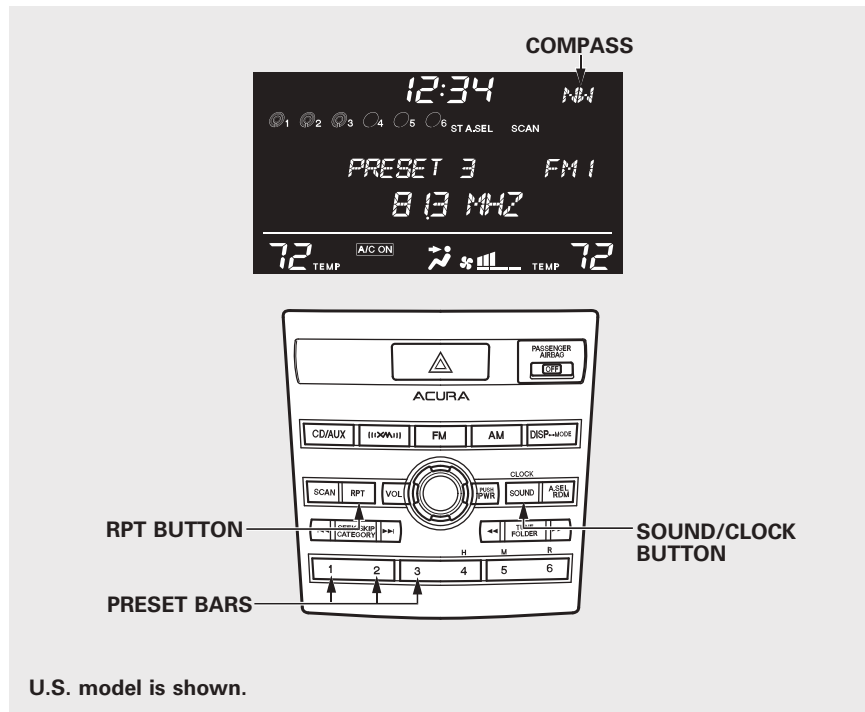

CONTINUED

Compass

Compass Calibration



If the compass direction is blinking and the CAL indicator is shown, the compass is self-calibrating.

The compass may need to be manually calibrated after exposure to a strong magnetic field. If the compass seems to be continually showing the wrong direction and is not self-calibrating, do the following.

NOTE: Do this procedure in an open area, away from buildings, power lines, and other vehicles.



1. Press and hold the SOUND/CLOCK and RPT buttons at the same time for about 2 seconds. You will hear a beep, then the display will change to the compass setting mode as shown above.

2. Select “CAL” by pressing preset 1 to enter the calibration mode. If you want to cancel this mode, select “R” by pressing preset 3. The display will return to the normal display.
3. Select “CAL START” by pressing preset 1. The system will start the calibration. “CAL” will appear on the display, then the direction will also begin to blink. If you select “R” by pressing preset 3, the display will return to the compass setting mode.

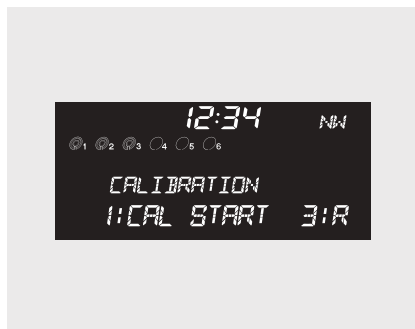

4. When the direction stops blinking, the calibration mode is completed. The display will return to the normal display.

Compass Zone Selection

In most areas, there is a variation between magnetic north and true north. Zone selection is required so the compass can compensate for this variation. To check and select the zone set into the compass, do the procedure on the following pages.

CONTINUED

Compass



1. Press and hold the SOUND/CLOCK and RPT buttons at the same time for about 2 seconds. You will hear a beep, then the center display will change to the compass setting mode as shown above.

2. Select "ZONE" by pressing preset 2 to enter the zone setting mode. The display will change to zone setting mode, and show you the current zone setting. If you want to cancel this mode, select "R" by pressing preset 3. The display will return to the normal display.
3. Find the zone for your area on the map (see [next page](#)).

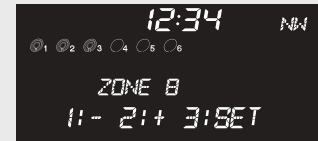

4. If the zone is incorrect, press preset 1 (-) or preset 2 (+) to get the zone number to count up and down. When you finish setting the correct zone, or want to cancel this mode without changing the current setting, select "SET" by pressing preset 3. The display will return to the normal display.

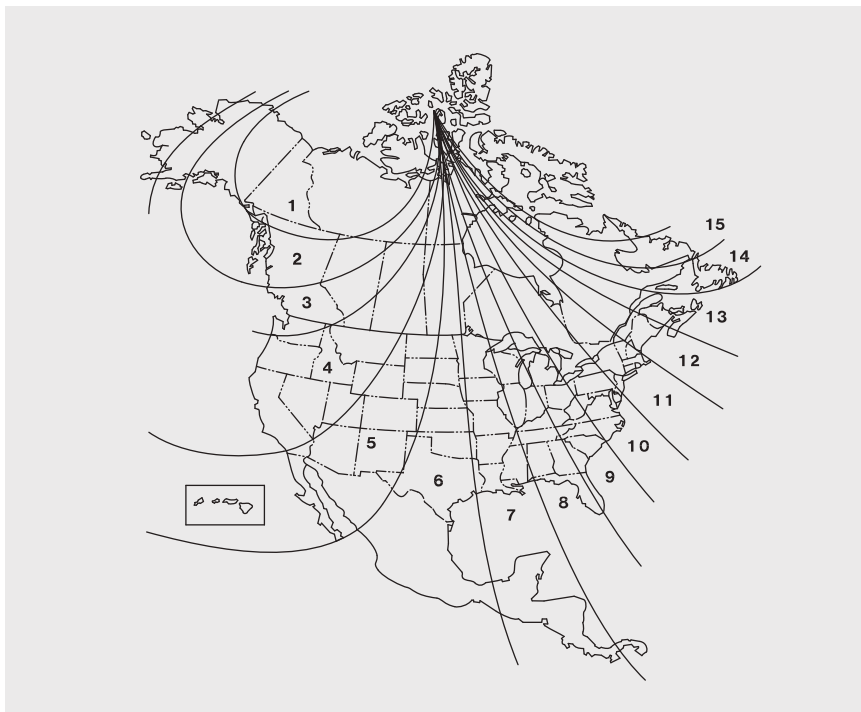

- * Guam Island : Zone 8
- * Puerto Rico : Zone 11

Cruise Control

Cruise control allows you to maintain a set speed above 25 mph (40 km/h) without keeping your foot on the accelerator pedal. It should be used for cruising on straight, open highways. It is not recommended for city driving, winding roads, slippery roads, heavy rain, or bad weather.

⚠ WARNING

Improper use of the cruise control can lead to a crash.

Use the cruise control only when traveling on open highways in good weather.

Using Cruise Control

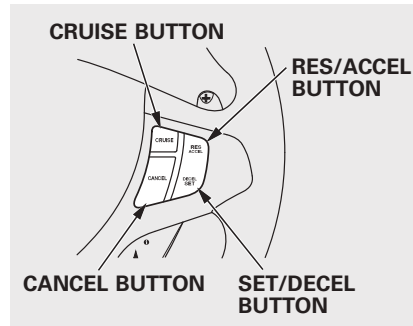

1. Push in the CRUISE button on the steering wheel. The CRUISE MAIN indicator on the instrument panel comes on.
2. Accelerate to the desired cruising speed above 25 mph (40 km/h).

3. Press and release the SET/DECEL button on the steering wheel. The CRUISE CONTROL indicator on the instrument panel comes on to show the system is now activated.

Cruise control may not hold the set speed when you are going up and down hills. If your vehicle speed increases going down a hill, use the brakes to slow down. This will cancel the cruise control. To resume the set speed, press the RES/ACCEL button. The CRUISE CONTROL indicator on the instrument panel will come back on.

When climbing a steep hill, the automatic transmission may downshift to hold the set speed.

Changing the Set Speed

You can increase the set cruising speed in any of these ways:

- Press and hold the RES/ACCEL button. When you reach the desired cruising speed, release the button.
- Push on the accelerator pedal. Accelerate to the desired cruising speed, then press the SET/DECEL button.
- To increase your speed in very small amounts, tap the RES/ACCEL button. Each time you do this, the vehicle speeds up about 1 mph (1.6 km/h).

You can decrease the set cruising speed in any of these ways:

NOTE: If you need to decrease your speed quickly, use the brakes as you normally would.

- Press and hold the SET/DECEL button. Release the button when you reach the desired speed.
- To slow down in very small amounts, tap the SET/DECEL button. Each time you do this, your vehicle will slow down about 1 mph (1.6 km/h).
- Tap the brake pedal lightly with your foot. The CRUISE CONTROL indicator on the instrument panel will go out. When the vehicle slows to the desired speed, press the SET/DECEL button.

Even with cruise control on, you can still use the accelerator pedal to speed up for passing. After completing the pass, take your foot off the accelerator pedal. The vehicle will return to the set cruising speed.

Resting your foot on the brake pedal causes cruise control to cancel.

CONTINUED

Cruise Control

Cancelling Cruise Control

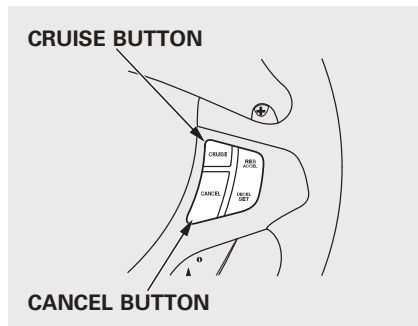

You can cancel cruise control in any of these ways:

- Tap the brake pedal.
- Push the CANCEL button on the steering wheel.
- Push the CRUISE button on the steering wheel.

The cruise control will be canceled when the vehicle speed reaches about 25 mph (40 km/h) or less.

Tapping either of the paddle shifters shifts the gear up or down, but the cruise control will be canceled if you downshift to first gear.

For more information on driving with paddle shifters, see page [380](#).

Resuming the Set Speed

When you push the CANCEL button or tap the brake pedal, the system remembers the previously set speed. To return to that speed, accelerate to above 25 mph (40 km/h), then press and release the RES/ACCEL button. The CRUISE CONTROL indicator comes on. The vehicle accelerates to the same speed as before.

Pressing the CRUISE button turns the system completely off and erases the previous cruising speed.

The HomeLink® Universal Transceiver built into your vehicle can be programmed to operate up to three remote controlled devices around your home, such as garage doors, lighting, or home security systems.

General Safety Information

Before programming your HomeLink to operate a garage door opener, confirm that the opener has an external entrapment protection system, such as an “electronic eye,” or other safety and reverse stop features.

If your garage door was manufactured before April 1, 1982, you may not be able to program HomeLink to operate it. These units do not have safety features that cause the motor to stop and reverse it if an obstacle is detected during closing, increasing the risk of injury. Do not use HomeLink with any garage door opener that lacks safety stop and reverse features.

Units manufactured between April 1, 1982 and January 1, 1993 may be equipped with safety stop and reverse features. If your unit does not have an external entrapment protection system, an easy test to confirm the function and performance of the safety stop and reverse feature is to lay a 2 × 4 under the closing door. The door should stop and reverse upon contacting the piece of wood. As an additional safety feature, garage door openers manufactured after January 1, 1993 are required to have external entrapment protection systems, such as an electronic eye, which detect an object obstructing the door.

Important Safety Precautions

Refer to the safety information that came with your garage door opener to test that the safety features are functioning properly. If you do not have this information, contact the manufacturer of the equipment. Before programming HomeLink to a garage door or gate opener, make sure that people and objects are out of the way of the device to prevent potential injury or damage. When programming a garage door opener, park just outside the garage.

Training HomeLink

Before you begin – If you just received your vehicle and have not trained any of the buttons in HomeLink before, you should erase any previously learned codes before training the first button. To do this, press and hold the two outside buttons on the HomeLink transceiver for about 20 seconds, until the red indicator flashes. Release the buttons, then proceed to step 1.

CONTINUED

HomeLink® Universal Transceiver

If you are training the second or third buttons, go directly to step 1.

Training a Button

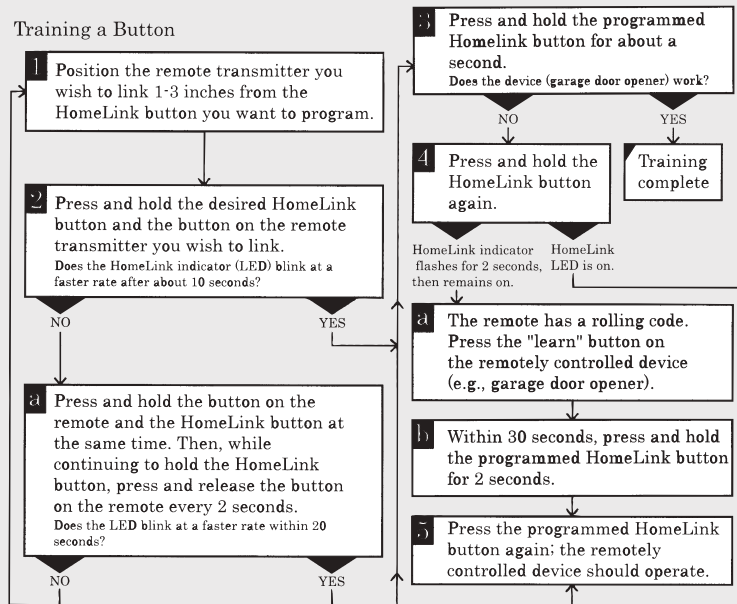

Retraining a Button

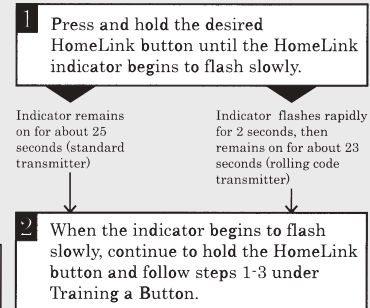

Erasing Codes

To erase codes stored in all buttons, press and hold the two outer buttons until the HomeLink indicator begins to flash (about 10 to 20 seconds), then release the buttons. You should erase all three codes before selling the vehicle.

If you have any problems programming HomeLink, see the owner's manual included with the device you are trying to program, or call HomeLink at 1-800-355-3515 or go online to www.homelink.com.

HomeLink® is a registered trademark of Johnson Controls, Inc.

*As required by the FCC:
This device complies with Part 15 of the FCC rules. Operation is subject to the following two conditions: (1) This device may not cause harmful interference, and (2) this device must accept any interference received, including interference that may cause undesired operation.*

Changes or modifications not expressly approved by the party responsible for compliance could void the user's authority to operate the equipment.

*This device complies with Industry Canada Standard RSS-210.
Operation is subject to the following two conditions: (1) this device may not cause interference, and (2) this device must accept any interference that may cause undesired operation of the device.*

Bluetooth® HandsFreeLink®

Bluetooth® HandsFreeLink® (HFL) allows you to place and receive phone calls using voice commands, without handling your cell phone.

To use HFL, you need a Bluetooth-compatible cell phone. For a list of compatible phones, pairing procedures, and special feature capabilities:

In the U.S., visit www.acura.com/handsfreelink, or call (888) 528-7876.

In Canada, visit www.acura.ca, or call (888) 9-ACURA-9.

Using HFL

HFL buttons

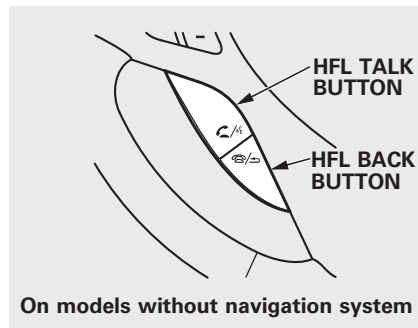

HFL Talk button — Press and release to give a command or answer a call.

HFL Back button — Press and release to end a call, go back to the previous command, or cancel the command.

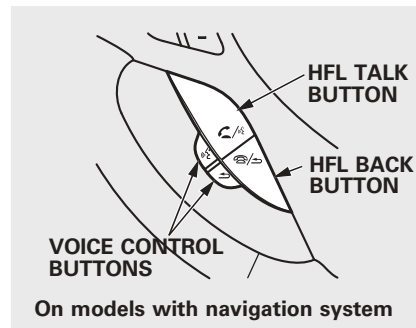

Below the HFL buttons is another set of voice control buttons for the navigation, climate control, and audio systems. To use the voice control system, refer to the navigation system manual.

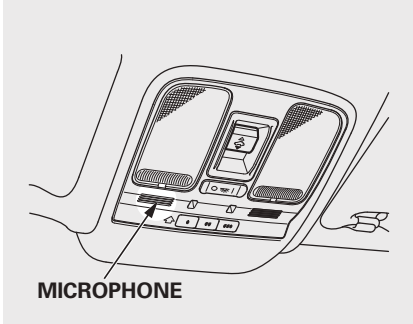
Voice Control Tips

- Air or wind noise from the dashboard and side vents and all windows may interfere with the microphone. Adjust or close them as necessary.

- Press and release the HFL Talk button each time you want to make a command. After the beep, speak in a clear, natural tone.
- Try to reduce all background noise. If the microphone picks up voices other than yours, commands may be misinterpreted.

- Many commands can be spoken together. For example, you can say “Call 123-456-7890” or “Dial Peter.”
- When HFL is in use, navigation voice commands cannot be recognized.
- To change the volume level of HFL, use the audio system volume knob or the steering wheel volume controls.

CONTINUED

Bluetooth® HandsFreeLink®

Help Features

- To hear general HFL information, including help on pairing a phone or setting up the system, say “Tutorial.”
- For help at any time, including a list of available commands, say “Hands free help.”

Information Display

As an incoming call notification, you will see the following display:

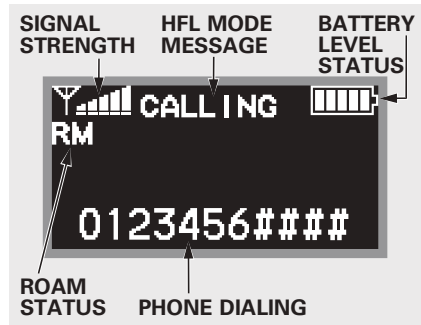

Some phones may send battery, signal strength, and roaming status information to HFL.

BLUETOOTH INDICATOR

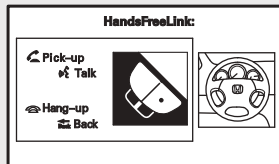

On models with navigation system

A notification that there is an incoming call, or HFL is in use, will appear on the navigation screen when the audio system is on.

BLUETOOTH INDICATOR

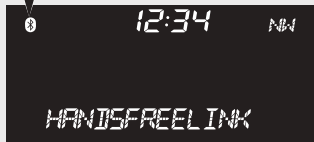

On models without navigation system

When there is an incoming call, or HFL is in use, "HANDSFREELINK" will appear on the display.

The *Bluetooth*® indicator  will also appear on the audio display when a phone is linked.

CONTINUED

Bluetooth® HandsFreeLink®

How to Use HFL

The ignition switch must be in the ACCESSORY (I) or ON (II) position.

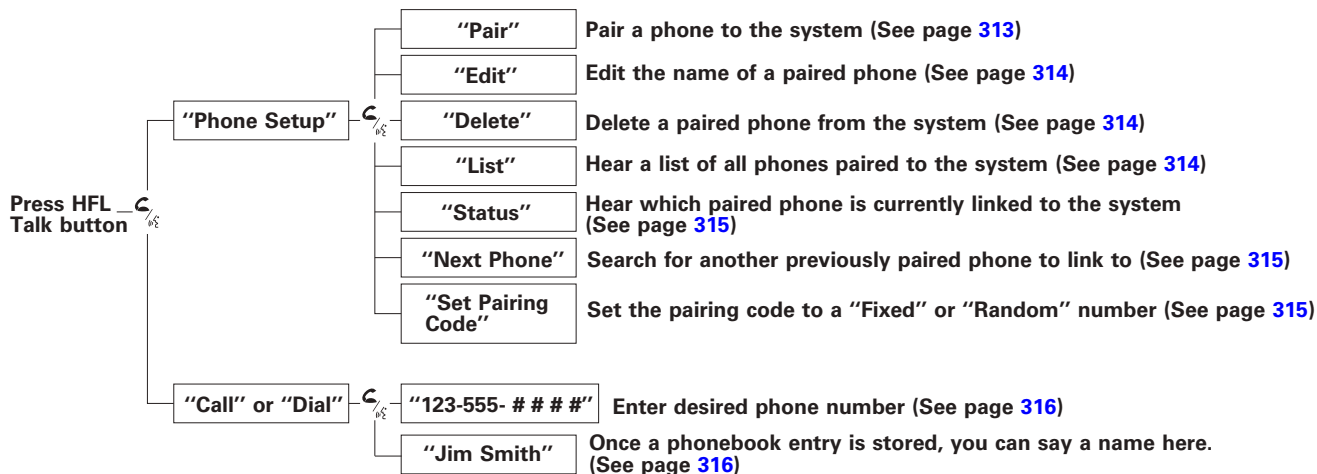

 Press and release the HFL Talk button each time you give a command.

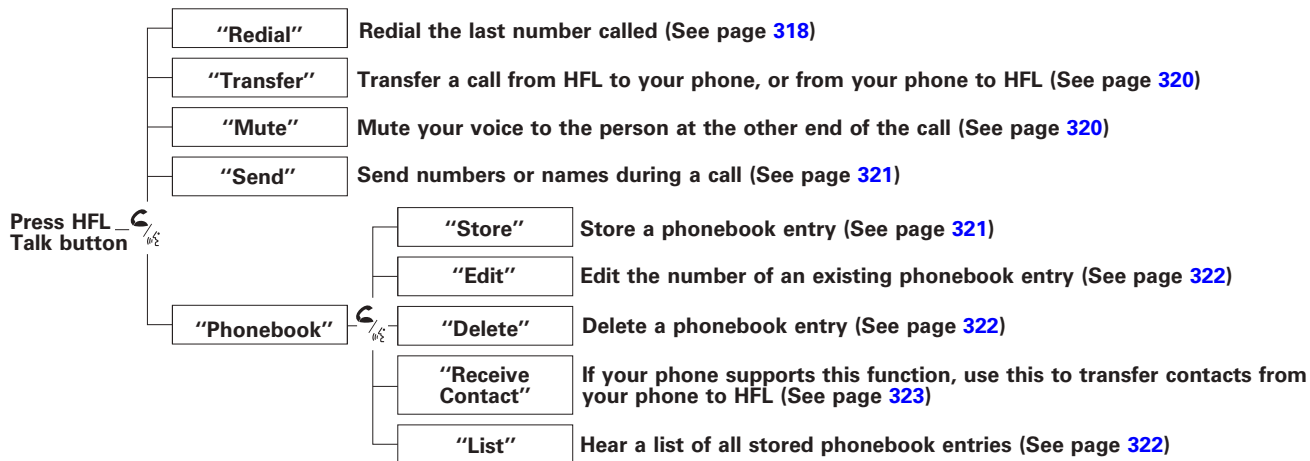

 Press and release the HFL Talk button each time you give a command.

CONTINUED

Bluetooth® HandsFreeLink®

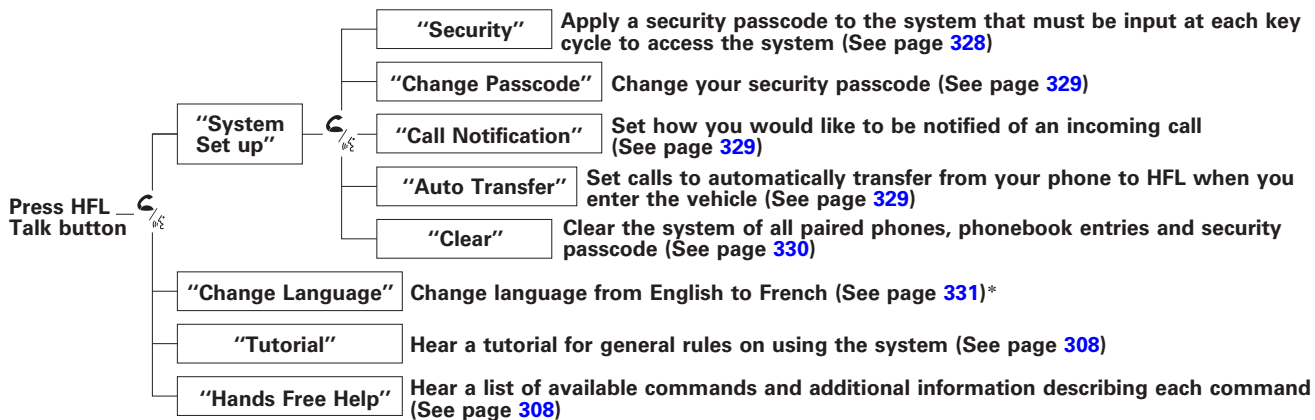

 Press and release the HFL Talk button each time you give a command.

* : Canadian models

To use HFL, you need to pair your Bluetooth-compatible cell phone to the system.

Phone Setup

This command group is available for paired cell phones.

Phone pairing tips

- You cannot pair your phone while the vehicle is moving.
- Your phone must be in discovery or search mode to pair. Refer to your phone's manual.
- Up to six phones can be paired.
- Your phone's battery may drain faster when it is paired to HFL.
- If after three minutes your phone is not ready to pair or a phone is not found, the system will time out and return to idle.

To pair a cell phone:

1. Press and release the HFL Talk button. If you are pairing a phone for the first time, HFL will give you information about the pairing process. If it is not the first phone you are pairing, say "**Phone setup**" and say "**Pair.**"
2. Follow the HFL prompts and put your phone in discovery or search mode. HFL will give you a 4-digit pairing code and begin searching for your phone.
3. When your phone finds a Bluetooth device, select HFL from the options and enter the 4-digit code from the previous step.
4. Follow the HFL prompts and name the newly paired phone.

On U.S. vehicles with navigation system

Once the pairing process is completed, AcuraLink may display a connection confirmation screen. This screen is used to create a data connection between your cell phone and the AcuraLink system. You can choose to set up the data connection later, or do it later. If you want to do it now, exit the HFL menu by pressing the HFL Back button one or more times.

CONTINUED

Bluetooth[®] HandsFreeLink[®]

To rename a paired phone:

Press and release the HFL Talk button before a command.

1. Say **“Phone setup.”**
2. Say **“Edit”** after the prompts.
3. If there is more than one phone paired to the system, HFL will ask you which phone’s name you want to change. Follow the HFL prompts and rename the phone.

To delete a paired phone:

Press and release the HFL Talk button before a command.

1. Say **“Phone setup.”**
2. Say **“Delete”** after the prompts.
3. HFL will ask you which phone you want to delete. Follow the HFL prompts to continue with the deletion.

To hear the names of all paired phones:

Press and release the HFL Talk button before a command.

1. Say **“Phone setup.”**
2. Say **“List”** after the prompts.
3. HFL will read out all the paired phone’s names.

To hear which paired phone is currently linked:

Press and release the HFL Talk button before a command.

1. Say “**Phone setup.**”
2. Say “**Status**” after the prompts.
3. HFL will tell you which phone is linked to the system.

To change from the currently linked phone to another paired phone:

Press and release the HFL Talk button before a command.

1. Say “**Phone setup.**”
2. Say “**Next Phone**” after the prompts.
3. HFL will tell you which phone is linked to the system.
4. Once another phone is found, it is linked to the system. HFL will inform you which phone is now linked.

If no other phones are found or paired, HFL will inform you that the original phone is linked again.

To change the pairing code setting:
Press and release the HFL Talk button before a command.

1. Say “**Phone setup.**”
2. Say “**Set pairing code**” after the prompts.
3. If you want HFL to create a random code each time you pair a phone, say “**Random.**” If you want to choose your own 4-digit code to be used each time, say “**Fixed**” and follow the HFL prompts.

CONTINUED

Bluetooth® HandsFreeLink®

Making a Call

You can make calls using any phone number or a name in the HFL phonebook. You can also redial the last number called.

HFL uses a Class 2 Bluetooth, which means, the maximum range between your phone and vehicle is 30 feet (10 meters).

During a call, HFL allows you to talk up to 30 minutes after you remove the key from the ignition switch. However, this may weaken the vehicle's battery.

To make a call using a phone number:

Press and release the HFL Talk button before a command.

1. Say **“Call”** or **“Dial.”**
2. Follow the HFL prompts and say the phone number you want to dial.
3. Follow the HFL prompts to confirm the number and say **“Call”** or **“Dial.”**

Once connected, you will hear the person you called through the audio speakers.

To make a call using a name in the HFL phonebook:

Press and release the HFL Talk button before a command.

1. Say **“Call”** or **“Dial.”**
2. Follow the HFL prompts and say the name stored in the HFL phonebook that you want to call.
3. Follow the HFL prompts to confirm the name and make the call.

To make a call using the navigation display (on models with navigation system):

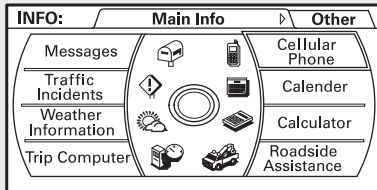

1. Press the INFO button, and the INFO screen will be shown.

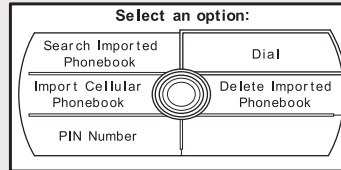

2. From the INFO screen, select "Cellular Phone," then select "Dial."

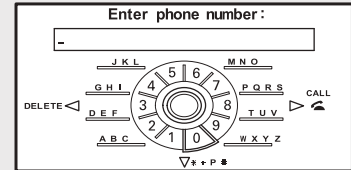

3. The navigation display will change as shown above. Enter a phone number.
4. To make a call, press the selector on the interface dial to the right.
5. To end the call, press the HFL Back button.

CONTINUED

Bluetooth® HandsFreeLink®***To redial the last number called by HFL:***

Press and release the HFL Talk button and say **“Redial.”**

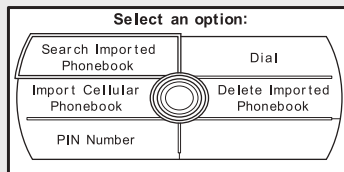
To make a call from an imported phonebook:

1. From the INFO screen, select **“Cellular Phone.”**
2. Select **“Search Imported Phonebook.”**

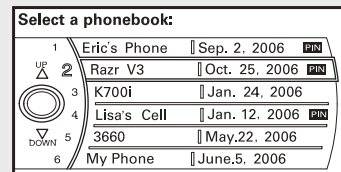

3. Select a phonebook you want to choose a phone number from.

If the phonebook you select is PIN protected, you will need to enter the PIN to access it. See page [326](#) for more information.

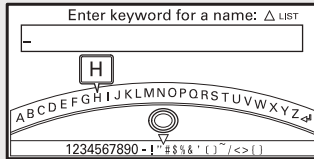

To search for a specific name in the phonebook, enter the keyword for either the first or last name.

To display all names in the phonebook, select the “List” option.

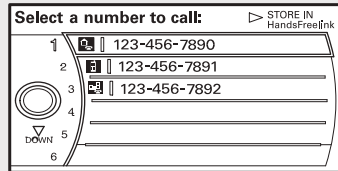

4. Select the name. All the phone numbers stored for that name will be listed.
5. Select the phone number, and HFL begins dialing.

If you choose “Store in HandsFreeLink,” the phone number will be stored in HFL, so you can call it using a voice tag.

CONTINUED

Bluetooth® HandsFreeLink®

Receiving a Call

When you receive a call, an incoming call notification (if activated) will play and interrupt the audio system if it is on.

Press the HFL Talk button to answer the call, or the HFL Back button to hang up.

Call Waiting

If your phone has Call Waiting, press and release the HFL Talk button to put the original call on hold and answer the incoming call.

To return to the original call, press the HFL Talk button again. If you don't want to answer the incoming call, disregard it and continue with your original call. If you want to hang up the original call and answer the new call, press the HFL Back button.

Transferring a Call

You can transfer a call from HFL to your phone, or from your phone to HFL.

Press and release the HFL Talk button and say “**Transfer.**”

Muting a Call

You can mute your voice to the person you are talking to during a call.

To mute your voice during a call, press and release the HFL Talk button and say “**Mute.**”

To unmute your voice, press and release the HFL Talk button and say “**Mute**” again.

Send Numbers or Names During a Call

HFL allows you to send numbers or names during a call. This is useful when you call a menu-driven phone system.

To send a name or number during a call:

Press and release the HFL Talk button before a command.

1. Say “Send.”
2. Follow the HFL prompts and say the name or number you want to send.
3. Follow the HFL prompts to send the tones and continue the call.

NOTE: To send a pound (#), say “pound.” To send a star (*), say “star.”

Phonebook

You can store up to 50 names with their associated numbers on HFL. The numbers you store can be not only phone numbers but other types, such as account numbers or passwords, which can be sent during a menu-driven call.

To store a phonebook entry:

Press and release the HFL Talk button before a command.

1. Say “**Phonebook.**”
2. Say “**Store**” after the prompts.
3. Say a name you want to list as your phonebook entry.
4. Say the number you want to store for the name entry.
5. Follow the HFL prompts and say “**Enter**” to store the entry.

NOTE:

- Avoid using duplicate name entries.
- Avoid using “home” as a name entry.
- It is easier for HFL to recognize a multisyllabic or longer name. For example, use “Peter” instead of “Pete,” or “John Smith” instead of “John.”

CONTINUED

Bluetooth[®] HandsFreeLink[®]

To edit the number stored in a name:

Press and release the HFL Talk button before a command.

1. Say **“Phonebook.”**
2. Say **“Edit”** after the prompts.
3. Follow the HFL prompts and say the name entry you want to edit.
4. When asked, say the new number for that name.
5. Follow the HFL prompts to complete the edit.

To delete a name:

Press and release the HFL Talk button before a command.

1. Say **“Phonebook.”**
2. Say **“Delete”** after the prompts.
3. Say the name you want to delete and follow the HFL prompts to complete the deletion.

To list all names in the phonebook:

Press and release the HFL Talk button before a command.

1. Say **“Phonebook.”**
2. Say **“List”** after the prompts.
3. HFL begins reading the names in the order they were stored.
4. If you hear a name you want to call, immediately press the HFL Talk button and say **“Call.”**

To store a specific phone number from your cell phone directly to the HFL phonebook (available on some phones):

Press and release the HFL Talk button before a command.

1. Say “**Phonebook.**”
2. Say “**Receive contact**” after the prompts.
3. Follow the HFL prompts, select a number from your cell phone, and send it to HFL.
4. Follow the HFL prompts and name the number, or say “**Discard**” if it is not the number you want to store.
5. Follow the HFL prompts if you want to store another number.

On models with navigation system **Cellular Phone Options** *(available on some phones)*

If you select **Cellular Phone** from the INFO screen menu, you will see five HFL options.

For a list of cell phones that are compatible with this feature:

In the U.S., visit www.acura.com/handsfreelink, or call (888) 528-7876.

In Canada, visit www.acura.ca, or call (888) 9-ACURA-9.

Import Cellular Phonebook:

The entire phonebook data of the cell phone that is linked to HFL can be imported to the navigation system.

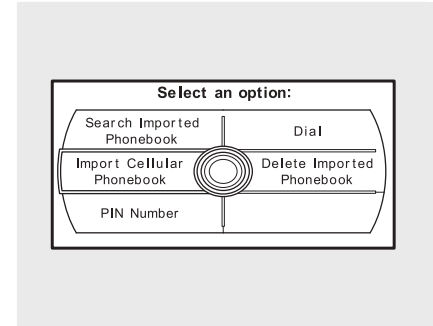

Select “**Import Cellular Phonebook,**” and HFL will begin importing the phonebook. Select “**OK**” after the import is completed.

CONTINUED

Bluetooth® HandsFreeLink®

Search Imported Phonebook:

Once a phonebook has been imported, you can search the phone numbers by the person's name.

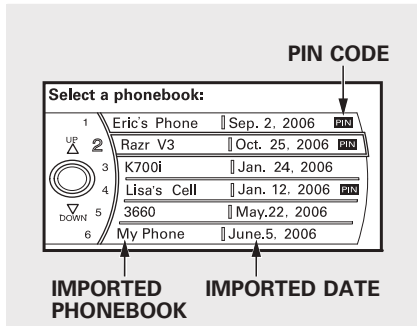

Select “**Search Imported Phonebook**,” and a list of imported phonebooks will be displayed.

Select a phonebook from the list.

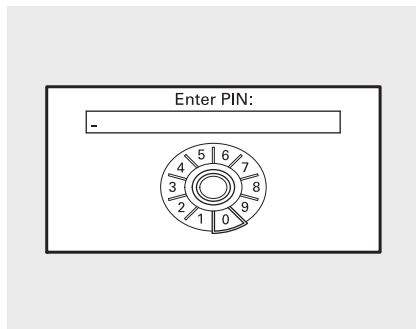

If the phonebook is PIN-protected, you will need to enter the 4-digit PIN.

Push up the interface selector to show a list.

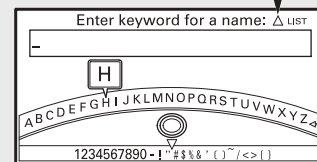

To search for a specific name in the phonebook, enter the keyword for either the first or last name.

To display all names in the phonebook, select the “List” option.

Select a person from the list. Up to three category icons are displayed in the left side of the list:

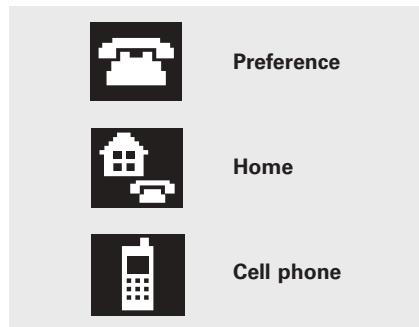

These category icons indicate how many numbers are stored for the name. If a name has more than three category icons, “...” is displayed.

Select the person’s number you want to call, and press the HFL Talk button.

CONTINUED

Bluetooth® HandsFreeLink®

Delete Imported Phonebook:

You can delete any imported phonebook.

Select **“Delete Imported Phonebook,”** and a list of imported phonebooks will be displayed.

Select a phonebook you want to delete. If the phonebook is PIN protected, you will need to enter the 4-digit PIN number.

After making a selection, the following screen will appear.

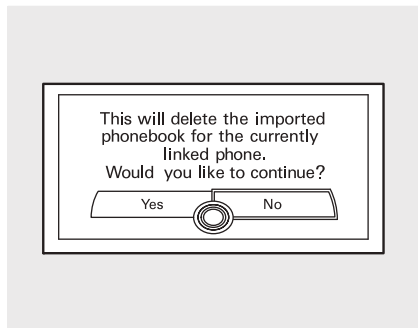

Select **“Yes,”** then **“OK”** to complete the deletion.

PIN Number

You can add, change, or remove a PIN number from any phonebook.

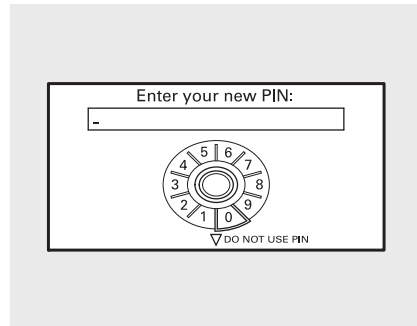

To add a PIN:

If you have selected a phonebook without a PIN, you will see the above display.

Enter the new 4-digit PIN. You will have to re-enter the PIN for confirmation.

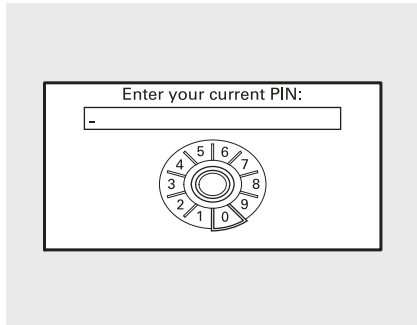
To change the PIN to a new number:

Select the phonebook you want. The display will change as shown above.

Enter the current PIN for this phonebook.

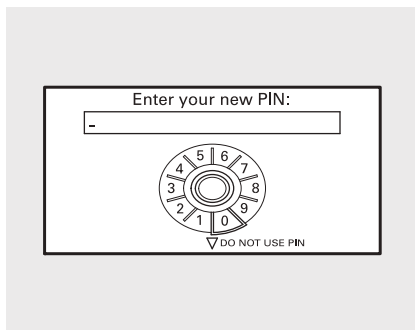

The display will change as shown above.

Enter the new 4-digit PIN number. You will be asked to re-enter the PIN for verification.

To remove a PIN:
Select “PIN number,” then select “Do not use PIN” after you enter the current PIN.

CONTINUED

Bluetooth® HandsFreeLink®

System Setup

This command group allows you to change or customize HFL basic settings.

To set a 4-digit passcode to lock the HFL system for security purposes:

Press and release the HFL Talk button before a command.

1. Say **“System setup.”**
2. Say **“Security”** after the prompts.
3. Follow the HFL prompts and say the 4-digit passcode you want to set.
4. Follow the HFL prompts to confirm the number.

NOTE: Once a passcode is set, you will need to enter it to use HFL each time you start the vehicle. If you forget the code, your dealer will have to reset it for you, or you will have to clear the entire system (see page [330](#)).

To change your security pass code:

Press and release the HFL Talk button before a command.

1. Say “**System setup.**”
2. Say “**Change passcode**” after the prompts.
3. Follow the HFL prompts and say the new 4-digit passcode.
4. Follow the HFL prompts to confirm the number.

To select either a ring tone or a prompt as the incoming call notification*:

Press and release the HFL Talk button before a command.

1. Say “**System setup.**”
2. Say “**Call notification**” after the prompts.
3. Follow the HFL prompts and say “**Ring tone**” or “**Prompt.**” You can also say “**Off**” for no audible incoming call notification.

*: The default setting is a ring tone.

To activate or deactivate the auto transfer function:

If you get into the vehicle while you are on the phone, the call can be automatically transferred to HFL with the ignition switch in the ACCESSORY (I) position.

1. Say “**System setup.**”
2. Say “**Auto transfer**” after the prompts.
3. HFL will let you know if auto transfer is on or off, depending on the previous setting. Follow the HFL prompts to change the setting.

CONTINUED

Bluetooth® HandsFreeLink®

To clear the system:

This operation clears the passcodes, paired phones, all names in the HFL phonebook, and all imported phonebook data.

Press and release the HFL Talk button before a command.

1. Say “**System setup.**”
2. Say “**Clear**” after the prompts.
3. Follow the HFL prompts to continue to complete the clearing procedure.

You can also clear the system when you have forgotten the passcode and cannot access HFL. When HFL asks you for the passcode, say “**System clear.**” Paired phones, all names in the HFL phonebook and all imported phonebook data will be lost.

Quick Language Selection ***Canadian models only***

To quickly change the language:

Press and release the HFL Talk button before a command.

1. Say the language you want to change to in that language.
2. Follow the HFL prompts.

Change Language *Canadian models only*

To change the system language between English and French:

Press and release the HFL Talk button before a command.

1. Say “**Change language.**”
2. Follow the HFL prompts to change the language to English or French.

If you have not named your paired phone in the language you just selected, HFL will ask you to name it in the current language.

When French is your currently selected language, you can give voice commands in French.

Bluetooth® Wireless Technology

The *Bluetooth®* name and logos are registered trademarks owned by Bluetooth SIG, Inc. and any use of such marks by Honda Motor Co., Ltd. is under license. Other trademarks and trade names are those of their respective owners.

HFL Limitations

An incoming call on HFL will interrupt *Bluetooth®* Audio when it is playing. Audio will resume when the call is ended.

U.S. models only

In addition, you cannot use HFL while using AcuraLink.

As required by the FCC:

This device complies with Part 15 of the FCC rules. Operation is subject to the following two conditions: (1) This device may not cause harmful interference, and (2) this device must accept any interference received, including interference that may cause undesired operation.

Changes or modifications not expressly approved by the party responsible for compliance could void the user's authority to operate the equipment.

This device complies with Industry Canada Standard RSS-210. Operation is subject to the following two conditions: (1) this device may not cause interference, and (2) this device must accept any interference that may cause undesired operation of the device.

AcuraLink® (U.S. models only)

On models with navigation system except Alaska, Hawaii, and Puerto Rico

AcuraLink enhances your ownership experience by providing a direct communication link between your vehicle and the Acura Server.

Working through the XM radio satellite, AcuraLink works in conjunction with the navigation system, *Bluetooth*® HandsFreeLink® (HFL), and audio system in your vehicle. It displays and receives several kinds of messages, including:

- Operating tips and information on your vehicle's features.
- Important recall and safety information.
- Maintenance information to keep your vehicle in top condition.
- Diagnostic information to provide information about any problems with your vehicle.

Interface Dial

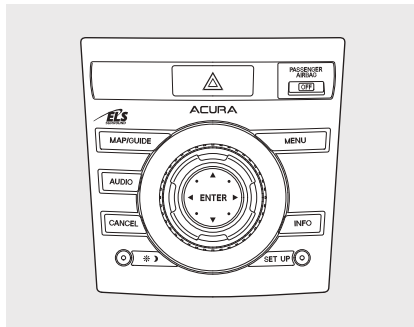

Most AcuraLink functions are controlled by the interface dial. The interface dial has two parts, a knob and a selector.

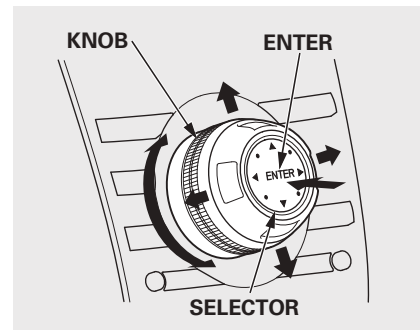

The knob turns left and right. Use it to make selections or adjustments to a list or menu on the screen.

The selector can be pushed left, right, up, down, and in. Use the selector to scroll through lists, to select menus, and to highlight menu items. When you make a selection, push the center of the selector (ENTER) to go to that selection.

Reading Messages

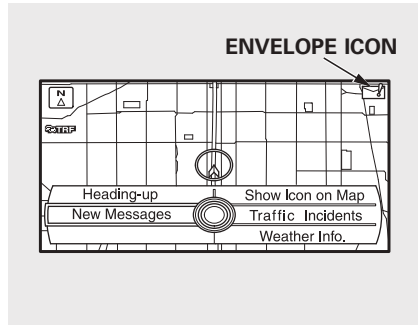

If you have new messages, an envelope icon appears in the top right corner of the navigation screen.

To open a message:

- Press ENTER on the interface selector, then select New Messages from the navigation system map menu. If there is more than one message stored in the system, you will see a list of message titles.

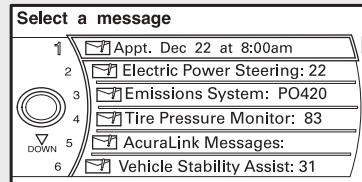

- Select “Messages” to display the “Select a message category:” screen. Then, select ALL MESSAGES.
- Scroll up or down, and select the message you want to read by pressing ENTER on the interface selector.

To view previously read messages:

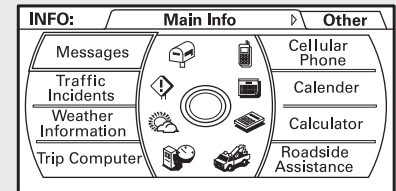

Press the INFO button, and the INFO screen will be shown.

CONTINUED

AcuraLink® (U.S. models only)

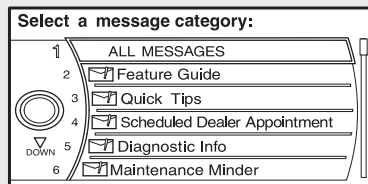

Select “Messages”, then select a message category. Select the message you want to read and press ENTER.

Unread messages have a closed envelope icon next to them. The icon disappears when it has already been read.

NOTE: Only diagnostic info messages overlay the screen while driving. They indicate that your vehicle has a problem that may need immediate attention (see page [345](#)).

After purchasing your vehicle, messages may not appear immediately. Your dealer has to register the vehicle identification before you can receive messages. This can take several days to process.

Deleting Messages

NOTE: Diagnostic info and recall/campaign messages can only be deleted by your dealer.

To delete a single message:

- Press the INFO button to bring up the Information screen.
- Scroll to the Messages option, then select it by pressing ENTER on the interface selector.
- Use the interface knob to scroll up or down to the message title you want to delete, and select it by pressing ENTER on the interface selector.
- Scroll to Delete with the interface knob, and select it by pressing ENTER on the interface selector.

To delete all messages:

NOTE: The Delete All Messages command does not apply to Recall or Diagnostic Info messages. These messages must be deleted by your dealer.

- Press the SET UP button to view the setup screen.
- Select MORE by pushing the interface selector to the right.
- Use the interface knob to scroll to the AcuraLink/Messages option, and select it by pressing ENTER on the interface selector.
- Scroll to the Delete Messages option, and select it by pressing ENTER on the interface selector.
- Scroll to the category with the messages you want to delete, and select the category by pressing ENTER on the interface selector.

Message Options

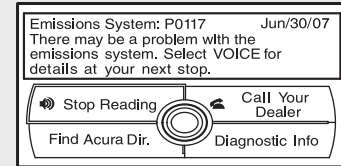

When you open a message, you can read a summary of it, and then choose one of several options. If an option is not available for a message, that option will not be highlighted.

CONTINUED

AcuraLink® (U.S. models only)

Delete – Select this option to delete the current message.

Voice – Select this option to hear a voice read the entire message. This gives you more information than the screen can display at one time. When you select the Voice option, it changes to a Stop Reading option. Select the option again to stop the voice.

Call – Select this button to call a phone number embedded in the message. When you select **Call**, the *Bluetooth*® HandsFreeLink® (HFL) dials the number for you.

To make a call, your *Bluetooth*® compatible phone must be paired to your vehicle's HandsFreeLink system, have its power on, and be inside the vehicle (see page 313).

Find Nearest Acura Dealer – Select this option to find the nearest Acura dealer using the navigation system.

Call Your Acura Dealer – Select this button to call the Acura dealer you purchased your vehicle from. AcuraLink also directs you to this dealer so you can schedule a maintenance appointment or receive information about a message. If you visit another dealer for service two times within a 14-month period, AcuraLink will reset to call that dealer.

Diagnostic Info – Select this button to get more information about the current diagnostic message. To use this option, your cell phone must be linked to the HFL and have a compatible data service available. Access the Owner Link website to find out which data services are currently compatible with AcuraLink.

Message Preferences

To set your AcuraLink preferences (the types of messages you want to receive, if any), visit the My Acura website at www.owners.acura.com. If you do not have internet access, call Acura Client Services at (800) 382-2238; they can set your message preferences for you.

AcuraLink/Message Screen

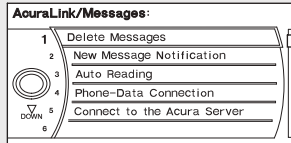
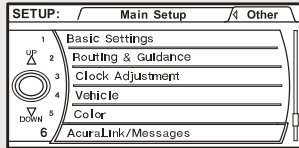

To access the following functions, press the SETUP button, push the interface selector to the right to select MORE, then rotate the interface knob to select AcuraLink/ Messages.

Delete Messages – Select this option to delete all stored messages within a category, except for diagnostic info and recall campaign messages. These messages can only be deleted by a certified technician after the recall is done or the problem is corrected, or through a broadcast message from Acura.

New Message Notification – Select ON if you want to be notified of new messages (envelope icon appears on the navigation screen). Select OFF if you do not want to be notified of new messages (envelope icon does not appear on the navigation screen).

Auto Reading – Select ON to have the system automatically read each message to you. Select OFF to manually select the Voice option when you want a message read to you.

Phone-Data Connection – Select this option to begin the process required to connect to Acura. This is used to access the most recent diagnostic information when a problem occurs.

CONTINUED

AcuraLink® (U.S. models only)

NOTE: For the Phone Data Connection button to be active, you need a *Bluetooth*® compatible and enabled cell phone paired to the *Bluetooth*® HandsFreeLink® (HFL). To complete the data connection setup, the paired phone must have a compatible data service.

To find more information on *Bluetooth*® compatible and enabled cell phones, visit www.acura.com/handsfreelink or call the HandsFreeLink® consumer support at 1-888-528-7876.

Connect to the Acura Server – The default setting is prompt. When a diagnostic info message appears, and you select the Check Now option, the system will prompt you before connecting to the Acura server. If you do not wish to connect at that time, select No at the prompt, and you will see the information from the onboard database. The “Auto” setting will remove the prompt when you select the Check Now option and will automatically connect to the Acura server. This setting only applies when you have a *Bluetooth*® enabled phone that is paired with HFL and you have completed the Phone-Data Connection setup.

Message Categories

There are six message categories in AcuraLink: Quick Tips, Feature Guides, Maintenance Minders, Recalls/Campaigns, Diagnostic Info, and Scheduled Dealer Appointment. The system can store up to 255 messages.

Message categories can be added, revised, or deleted through broadcast messages from Acura.

Quick Tips

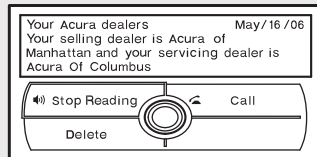

These messages, based on updated vehicle information and comments from other RDX owners, supplement your Owner's Manual and Advanced Technology Guide. They provide you with relevant information for a safe and enjoyable ownership experience. For additional information, call Acura Client Services directly through the HFL.

Feature Guide

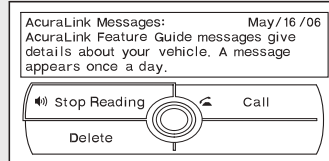

During the first 90 days of ownership, one of 22 different messages appears each day. These messages help you to use and understand the technological features of your vehicle.

Maintenance Minder

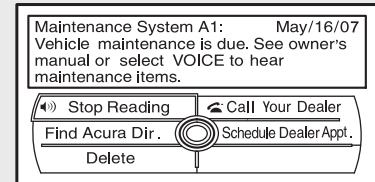

These messages provide detailed information about the service needed for your vehicle. When a maintenance message appears on the multi-information display, a list of needed maintenance items is provided through an AcuraLink message. These messages tell you the exact maintenance needed, helping you to avoid unnecessary maintenance costs.

CONTINUED

AcuraLink® (U.S. models only)

You can use the following message options:

- Make an appointment from the schedule at the dealer.
- Reschedule the appointment with the dealer.
- Call your dealer for an appointment.
- Find the nearest dealer.

Automated Appointment

You can make an appointment with your dealer through the AcuraLink when you receive a maintenance minder message.

To use the automated appointment function, you should visit the Owner Link website at www.owners.acura.com, register some required settings, and complete the Phone-Data Connection set-up (see page 337). Your *Bluetooth*® compatible phone should also be paired and linked to your vehicle's *Bluetooth*® HFL (see page 313).

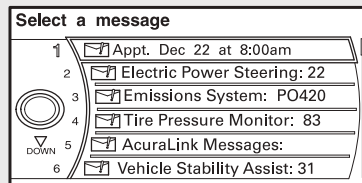

When you see the maintenance minder message on the multi-information display, you will also receive a message in the navigation screen. To open the message, press ENTER. Select “New Messages,” then press ENTER. You will see the list of all messages. The most recent message is listed at the top.

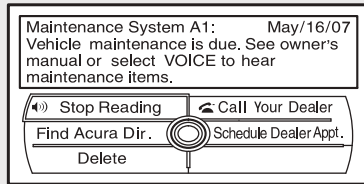

Select the received message, then press ENTER. You will see the message as shown. To make an appointment, select “Schedule Dealer Appt.” then press ENTER.

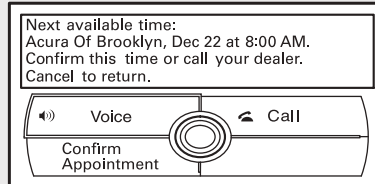

The system will automatically connect to the Acura server, then show you an appropriate appointment date and time on the navigation screen. If you accept this appointment, select “Confirm Appointment,” then press ENTER.

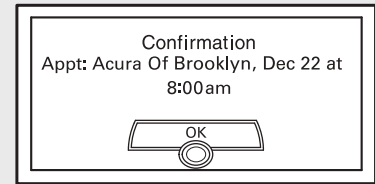

The confirmation message will be displayed on the screen. Make sure to confirm the appointment date, time and dealer. If it is OK, press ENTER.

If you want to change or reschedule the appointment date, select “Cancel,” then press ENTER.

CONTINUED

AcuraLink® (U.S. models only)

Scheduled Dealer Appointment

To reschedule the appointment:

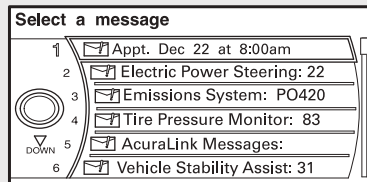

Press the INFO button to go to the information screen, select “Messages,” and select “Scheduled Dealer Appointment” from the message category list. Then press ENTER.

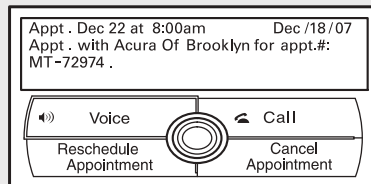

You will see the screen to reschedule as shown. To make an appointment, select “Reschedule Appointment,” then press ENTER.

The system will automatically connect to the Acura server, then show you a new appointment date and time on the navigation screen. If you accept this appointment, select “Confirm Appointment,” then press ENTER.

To cancel the appointment:

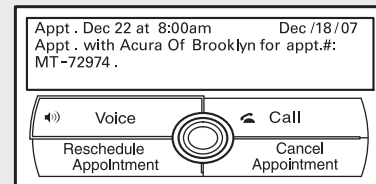

Select “Messages” on the information screen, then press ENTER. Select “Scheduled Dealer Appointment” from the message category list. Then press ENTER. To cancel the appointment, select “Cancel Appointment.”

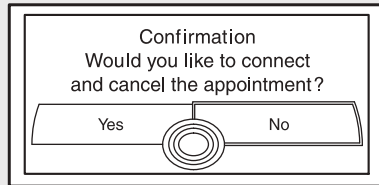

The system will request you to confirm the cancel on the navigation screen. To cancel the appointment, select "YES," then press ENTER. If you select "NO," the screen goes back to the previous message display.

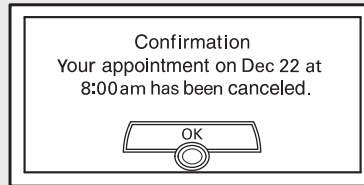

The system will automatically connect to the Acura server, then show you the confirmation on the navigation screen. If you accept the cancel, press ENTER.

If you select the cancel appointment, you cannot try to reschedule the appointment. If you want to change or reschedule the appointment date, call your dealer directly with HFL.

CONTINUED

AcuraLink® (U.S. models only)

Using automated appointment, your registered dealer through Owner Link is automatically selected. If you want to select another dealer, such as in case of an emergency, find the nearest dealer and call the dealer directly with HFL.

When a maintenance appointment is due soon, you will also receive an appointment reminder message.

Recall/Campaigns

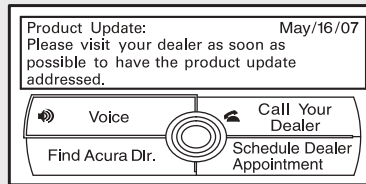

If your vehicle is affected by a recall or other important safety information, a letter will be mailed to you about the issue and how to fix it. If you don't get your vehicle fixed, you will also receive a reminder message through AcuraLink. You can then use the message options to call your dealer for an appointment or to find the nearest dealer.

For this reason, it is important that we retain your current phone number. Please update your information using My Acura at www.owners.acura.com.

Diagnostic Info

When an indicator comes on or a message is displayed on the Multi-Information Display (MID), AcuraLink can provide information about the cause of the indicator or message and the recommended action to address it. This helps you handle the problem as it occurs, preventing or limiting costly repairs.

The AcuraLink system cannot determine some mechanical problems (such as squeaks or rattles) that are not triggered by the diagnostic indicator monitors.

A diagnostic message is generated if any of the instrument panel indicators stay on when they should go off. For more information on the instrument panel indicators, see page 63.

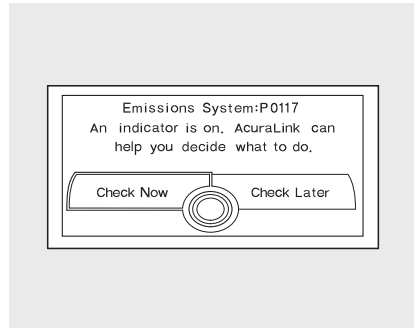

When an instrument panel indicator comes on or a message is displayed on the MID, AcuraLink immediately notifies you with the message, "Check more information." If you do not want the information right away, select the Check Later option. If you want the information now, select the Check Now option. (If the navigation screen is not active, you must select OK from the navigation disclaimer screen before you can check the information.)

Depending on the severity of the problem, the message will let you know if you should see your dealer immediately or if you can wait a while.

CONTINUED

AcuraLink® (U.S. models only)

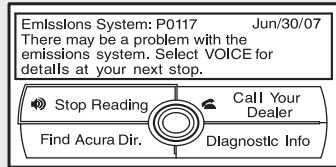

You will see information from the onboard troubleshooting database.

You can then use message options to call your dealer for an appointment, to find the nearest dealer, or to find out more information about the issue.

When you select the Diagnostic Info option, if the HFL is connected to a cellular data service, AcuraLink gathers more information about the problem, and sends it to Acura. There, the information is analyzed and returned to the vehicle with the most accurate repair information.

NOTE: There may not be any additional information, depending on the time elapsed since the previous time you retrieved the information from the Acura server.

Reminder Message

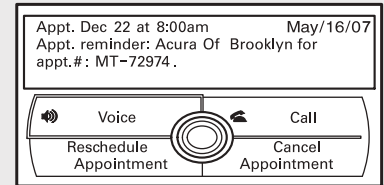

When you make an appointment through My Acura's online Schedule Service Appointment, you can be reminded in advance about that appointment through AcuraLink.

If you need to reschedule or cancel the appointment, see page [342](#).

Turning the Automated Appointment preference off will disable appointment notifications in the vehicle based on appointments created or changed at My Acura's online scheduling website.

Appointments can still be created, rescheduled, and canceled from the vehicle; however, the appointment information stored in the vehicle will not be updated. Any changes to those appointments should be made from the My Acura website.

As required by the FCC:

This device complies with Part 15 of the FCC rules. Operation is subject to the following two conditions: (1) This device may not cause harmful interference, and (2) this device must accept any interference received, including interference that may cause undesired operation.

Changes or modifications not expressly approved by the party responsible for compliance could void the user's authority to operate the equipment.

This device complies with Industry Canada Standard RSS-210.

Operation is subject to the following two conditions: (1) this device may not cause interference, and (2) this device must accept any interference that may cause undesired operation of the device.

Rearview Mirror with Rearview Camera Display

On models with navigation system

Refer to the navigation system manual for operation of the rearview camera.

On models without navigation system

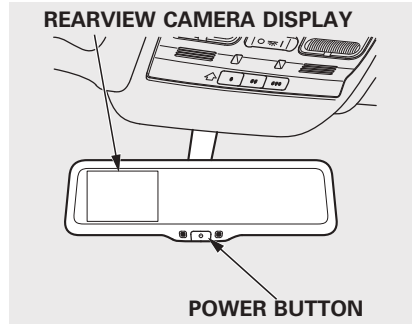

You can turn the camera display on and off by pressing the power button when the shift lever is in reverse. The camera display turns on everytime you shift to reverse, even if you turned it off the last time.

Whenever you shift to reverse (R) with the ignition switch in the ON (II) position, the rearview appears on a display in the rearview mirror.

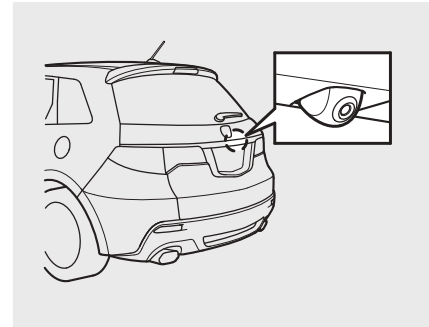

For the best picture, always keep the rearview camera clean, and do not cover the camera lens. To avoid scratching the lens when you clean it, use a moist, soft cloth.

Since the rearview camera display area is limited, you should always back up slowly and carefully, and look behind you for obstacles.

Rearview Mirror with Rearview Camera Display

If the engine has just been started, it may take a short time for the system to display the rearview.

The camera display brightness is adjusted automatically by sensors. If you use the camera display continuously at high temperature, the image will gradually dim and eventually turn off automatically. If you change to another shift position, the camera display will come on again when you return to reverse.

The inside mirror will be hot when you use the monitor for an extended period of time.

If a bright light (such as sunlight) is reflected on the mirror, the image may be difficult to see.

Rearview Camera Guide Line

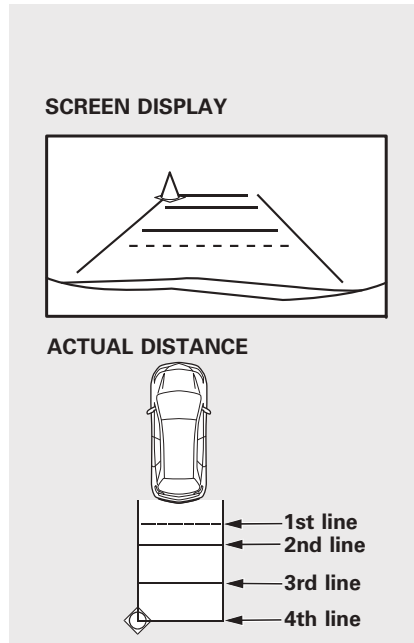

The camera display has parking guide lines that indicate distance from your vehicle.

| | |
|----------|-------------|
| 1st Line | 24in (0.6m) |
| 2nd Line | 39in (1m) |
| 3rd Line | 79in (2m) |
| 4th Line | 118in (3m) |

NOTE

- The rearview camera has a unique lens that makes objects appear closer than they actually are.
- The rearview camera display has a limited coverage, and the size and position of objects may appear different than they actually are. Make sure to check the surrounding area carefully.

To turn the guide line on and off, hold the power button for more than 3 seconds when the shift is in reverse, the on/off setting will be kept when you change gear and return to reverse.

[Main Menu](#)

[Table of Contents](#)

Before you begin driving your vehicle, you should know what gasoline to use and how to check the levels of important fluids. You also need to know how to properly store luggage or packages. The information in this section will help you. If you plan to add any accessories to your vehicle, please read the information in this section first.

| | |
|--|-----|
| Break-in Period | 352 |
| Fuel Recommendation | 352 |
| Service Station Procedures | 353 |
| Refueling..... | 353 |
| Tighten Fuel Cap Message | 354 |
| Opening and Closing the Hood..... | 355 |
| Oil Check..... | 356 |
| Engine Coolant Check | 357 |
| Fuel Economy | 358 |
| Accessories and Modifications | 362 |
| Carrying Cargo | 364 |

Break-in Period, Fuel Recommendation

Break-in Period

Help assure your vehicle's future reliability and performance by paying extra attention to how you drive during the first 600 miles (1,000 km). During this period:

- Avoid full-throttle starts and rapid acceleration.
- Avoid hard braking for the first 200 miles (300 km).
- Do not change the oil until the scheduled maintenance time.
- Do not tow a trailer.

You should also follow these recommendations with an overhauled or exchanged engine, or when the brakes are replaced.

Fuel Recommendation

Your vehicle is designed to operate on premium unleaded gasoline with a pump octane of 91 or higher. If this octane grade is unavailable, regular unleaded gasoline with a pump octane of 87 or higher may be used temporarily. The use of regular unleaded gasoline can cause metallic knocking noises in the engine and will result in decreased engine performance. The long-term use of regular-grade gasoline can lead to engine damage.

NOTICE

Avoid driving with an extremely low fuel level. Running out of fuel could cause the engine to misfire, damaging the catalytic converter.

We recommend using quality gasolines containing detergent additives that help prevent fuel system and engine deposits.

In addition, in order to maintain good performance, fuel economy, and emissions control, we strongly recommend, in areas where it is available, the use of gasoline that does NOT contain manganese-based fuel additives such as MMT.

Use of gasoline with these additives may adversely affect performance, and cause the malfunction indicator lamp on your instrument panel to come on. If this happens, contact your authorized dealer for service.

Fuel Recommendation, Service Station Procedures

Some gasoline today is blended with oxygenates such as ethanol or MTBE. Your vehicle is designed to operate on oxygenated gasoline containing up to 10% ethanol by volume and up to 15% MTBE by volume. Do not use gasoline containing methanol.

If you notice any undesirable operating symptoms, try another service station or switch to another brand of gasoline.

For further important fuel-related information for your vehicle, or information on gasoline that does not contain MMT, visit MyAcura.com

In Canada, visit www.acura.ca for additional information on gasoline.

Refueling

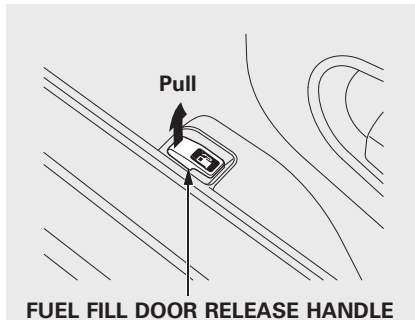

1. Park with the driver's side closest to the service station pump.
2. Open the fuel fill door by pulling on the handle at the outside of the driver's seat.

⚠ WARNING

Gasoline is highly flammable and explosive. You can be burned or seriously injured when handling fuel.

- Stop the engine, and keep heat, sparks, and flame away.
- Handle fuel only outdoors.
- Wipe up spills immediately.

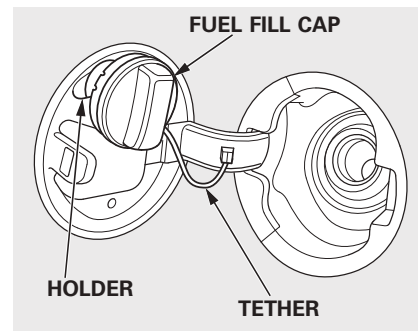

CONTINUED

Service Station Procedures

3. Remove the fuel fill cap slowly. You may hear a hissing sound as pressure inside the tank equalizes. Place the cap in the holder on the fuel fill door.
4. Stop filling the tank after the fuel nozzle automatically clicks off. Do not try to “top off” the tank. This leaves some room in the fuel tank for the fuel to expand with temperature changes.

If the fuel nozzle keeps clicking off even though the tank is not full, there may be a problem with your vehicle's fuel vapor recovery system. The system helps keep fuel vapor from going into the atmosphere. Try filling at another pump. If this does not fix the problem, consult your dealer.

5. Screw the fuel fill cap back on until it clicks at least once. If you do not properly tighten the cap, you will see a “TIGHTEN FUEL CAP” message on the multi-information display (see right column on this page), and the malfunction indicator lamp may also come on (see page [466](#)).
6. Push the fuel fill door closed until it latches.

Tighten Fuel Cap Message



If your fuel fill cap is loose or missing, a “TIGHTEN FUEL CAP” message appears on the multi-information display after you start the engine.

Turn the engine off, and confirm the fuel fill cap is installed. If it is, loosen it, then retighten it until it clicks at least once. When you can restart the engine, the message appears again. The message goes off after several days of normal driving once you tighten or replace the fuel fill cap. To scroll to another message, press the INFO (▲/▼) button.

If the system still detects a leak in your vehicle's evaporative emissions system, the malfunction indicator lamp (MIL) comes on. If the fuel fill cap was not already tightened, turn the engine off, and check or retighten the fuel fill cap until it clicks at least once. The MIL should go off after several days of normal driving once the cap is tightened or replaced. If the MIL does not go off, have your vehicle inspected by a dealer. For more information, see page 466.

Opening and Closing the Hood



1. Park the vehicle, and set the parking brake. Pull the hood release handle located under the lower left corner of the dashboard. The hood will pop up slightly.

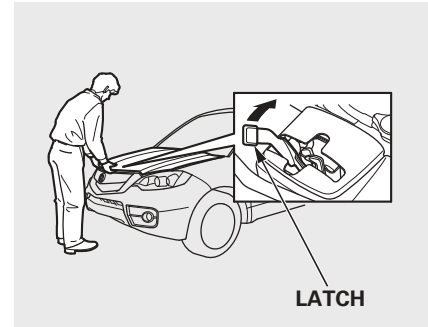

2. Put your fingers under the front edge of the hood near the center. Slide your hand to the left until you feel the hood latch handle. Push this handle up to release it. Lift up the hood.

If the hood latch handle moves stiffly, or if you can open the hood without lifting the handle, the mechanism should be cleaned and lubricated.

CONTINUED

Service Station Procedures

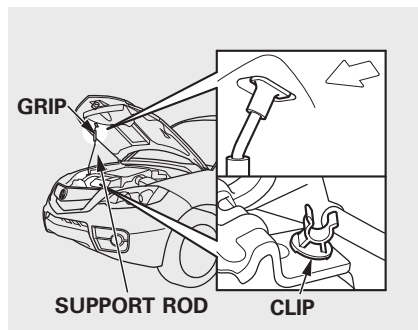

3. Holding the grip, pull the support rod out of its clip. Insert the end into the designated hole in the hood.

To close the hood, lift it up slightly to remove the support rod from the hole. Put the support rod back into its holding clip. Lower the hood to about a foot (30 cm) above the fender, then let it drop. Make sure it is securely latched.

Oil Check

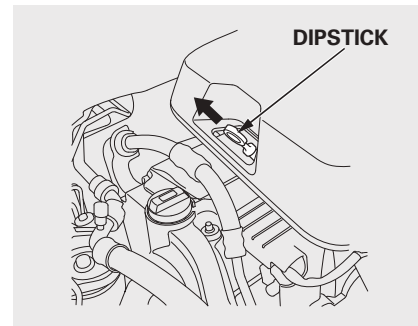

Park the vehicle on a level surface. Wait a few minutes after turning the engine off before you check the oil.

1. Remove the dipstick (orange loop).
2. Wipe off the dipstick with a clean cloth or paper towel.
3. Hold the dipstick with a clean cloth or paper towel, and then insert it all the way back in its hole.

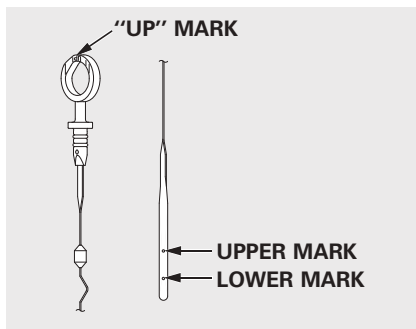

Make sure the "UP" mark on the loop is facing up when you insert the dipstick.

4. Remove the dipstick again, and check the level. It should be between the upper and lower marks.

If it is near or below the lower mark, see **Adding Engine Oil** on page 420.

Engine Coolant Check

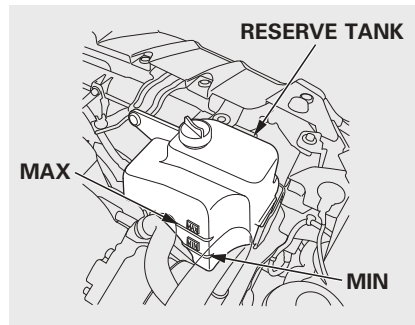

Look at the coolant level in the radiator reserve tank. Make sure it is between the MAX and MIN lines. If it is below the MIN line, see **Adding Engine Coolant** on page 424 for information on adding the proper coolant.

Refer to **Owner's Maintenance Checks** on page 417 for information about checking other items on your vehicle.

Fuel Economy

Actual Mileage and EPA Fuel Economy Estimates Comparison.

Fuel economy is not a fixed number. It varies based on driving conditions, driving habits and vehicle condition. Therefore, it is not possible for one set of estimates to predict fuel economy precisely for all drivers in all environments.

The EPA fuel economy estimates shown in the example to the right are a useful tool for comparison when buying a vehicle. EPA estimates include:

City MPG – Represents urban driving in a vehicle in light traffic. A range of miles per gallon achieved is also provided.

Highway MPG – Represents a mixture of rural and interstate driving, in a warmed-up vehicle, typical of longer trips in free-flowing traffic. A range of miles per gallon achieved is also provided.

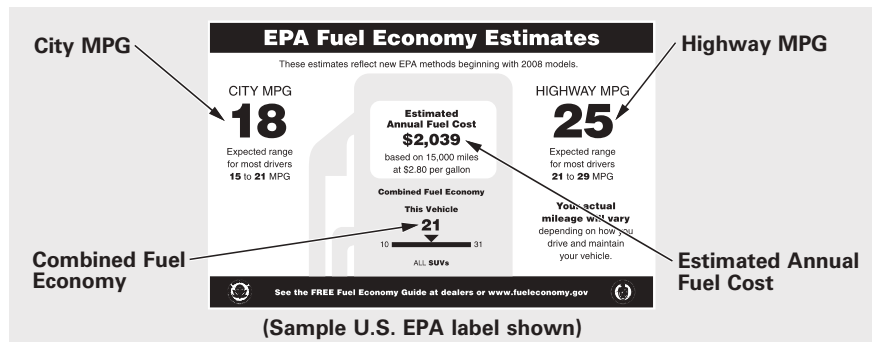

Combined Fuel Economy – Represents a combination of city and highway driving. The scale represents the range of combined fuel economy for other vehicles in the class.

Estimated Annual Fuel Cost – Provides an estimated annual fuel cost, based on 15,000 miles (20,000 km) per year multiplied by the cost per gallon (based on EPA fuel cost data) divided by the combined fuel economy.

For more information on fuel economy ratings and factors that affect fuel economy, visit www.fueleconomy.gov (Canada: Visit www.vehicles.gc.ca)

Fuel Economy Factors

The following factors can lower your vehicle's fuel economy:

- Aggressive driving (hard acceleration and braking)
- Excessive idling, accelerating and braking in stop-and-go traffic
- Cold engine operation (engines are more efficient when warmed up)
- Driving with a heavy load or the air conditioner running
- Improperly inflated tires

Improving Fuel Economy

Vehicle Maintenance

A properly maintained vehicle maximizes fuel economy. Poor maintenance can significantly reduce fuel economy. Always maintain your vehicle according to the maintenance messages displayed on the information display (see **Owner's Maintenance Checks** on page 417). For example:

- **Use the required engine oil** (see page 420).
- **Maintain proper tire inflation** – An underinflated tire increases “rolling resistance,” which reduces fuel economy.
- **Avoid carrying excess weight in your vehicle** – It puts a heavier load on the engine, increasing fuel consumption.

- **Keep your vehicle clean** – In particular, a build-up of snow or mud on your vehicle's underside adds weight and rolling resistance. Frequent cleaning helps your fuel economy.

CONTINUED

Fuel Economy

Drive Efficiently

- **Drive moderately** – Rapid acceleration, abrupt cornering, and hard braking increase fuel consumption.
- **Observe the speed limit** – Aerodynamic drag has a big effect on fuel economy at speeds above 45 mph (75 km/h). Reduce your speed and you reduce the drag. Trailers, car top carriers, roof racks and bike racks are also big contributors to increased drag.
- **Always drive in the highest gear possible** – If your vehicle has a manual transmission, you can boost your fuel economy by up shifting as early as possible.
- **Avoid excessive idling** – Idling results in 0 miles per gallon (0 kms per liter).
- **Minimize the use of the air conditioning system** – The A/C puts an extra load on the engine which makes it use more fuel. Use the fresh-air ventilation when possible.
- **Plan and combine trips** – Combine several short trips into one. A warmed-up engine is more fuel efficient than a cold one.

Calculating Fuel Economy

Measuring Techniques

Direct calculation is the recommended source of information about your actual fuel economy. Using frequency of fill-ups or taking fuel gauge readings are NOT accurate measures of fuel economy. Fuel economy may improve over the first several thousand miles.

Checking Your Fuel Economy

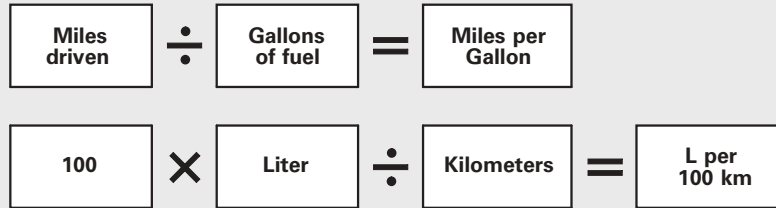

- 1) Fill the fuel tank until the nozzle automatically clicks off.
- 2) Reset trip counter to zero.
- 3) Record the total gallons (liters) needed to refill.
- 4) Follow one of the simple calculations above.

Accessories and Modifications

Modifying your vehicle, or installing some non-Acura accessories, can make your vehicle unsafe. Before you make any modifications or add any accessories, be sure to read the following information.

Accessories

Your dealer has Acura accessories that allow you to personalize your vehicle. These accessories have been designed and approved for your vehicle, and are covered by warranty.

Although non-Acura accessories may fit on your vehicle, they may not meet factory specifications, and could adversely affect your vehicle's handling and stability.

⚠ WARNING

Improper accessories or modifications can affect your vehicle's handling, stability, and performance, and cause a crash in which you can be hurt or killed.

Follow all instructions in this owner's manual regarding accessories and modifications.

When properly installed, cellular phones, alarms, two-way radios, and low-powered audio systems should not interfere with your vehicle's computer controlled systems, such as your airbags, anti-lock brakes, and tire pressure monitoring system.

Before installing any accessory:

- Make sure the accessory does not obscure any lights, or interfere with proper vehicle operation or performance.
- Be sure electronic accessories do not overload electrical circuits (see page 469) or interfere with proper operation of your vehicle.
- Before installing any electronic accessory, have the installer contact your dealer for assistance. If possible, have your dealer inspect the final installation.
- Do not install accessories on the side pillars or across the rear windows. Accessories installed in these areas may interfere with proper operation of the side curtain airbags.

Modifying Your Vehicle

Removing parts from your vehicle, or replacing components with non-Acura components could seriously affect your vehicle's handling, stability, and reliability.

Here are some examples:

- Lowering the vehicle with a non-Acura suspension kit that significantly reduces ground clearance can allow the undercarriage to hit speed bumps or other raised objects, which could cause the airbags to deploy.
- Raising your vehicle with a non-Acura suspension kit can affect the handling and stability.

- Non-Acura wheels, because they are a universal design, can cause excessive stress on suspension components and will not be compatible with the tire pressure monitoring system (TPMS).
- Larger or smaller wheels and tires can interfere with the operation of your vehicle's anti-lock brakes and other systems.
- Modifying your steering wheel or any other part of your vehicle's safety features can make the systems ineffective.

If you plan to modify your vehicle, consult your dealer.

Carrying Cargo

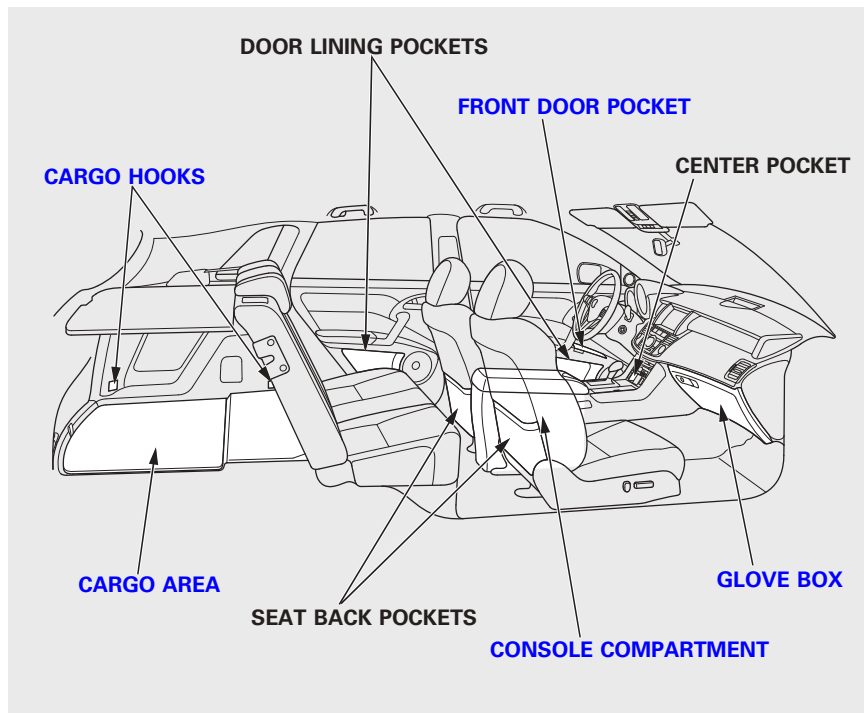

Your vehicle has several convenient storage areas:

- Glove box
- Front door pockets
- Door lining pockets
- Seat-back pockets
- Center pocket
- Console compartment
- Cargo area, including the rear seats when folded down.
- **Roof-rack** (if equipped)

However, carrying too much cargo, or improperly storing it, can affect your vehicle's handling, stability, stopping distance, and tires, and make it unsafe. Before carrying any type of cargo, be sure to read the following pages.

Load Limits

The maximum load for your vehicle is 870 lbs (395 kg).

See Tire And Loading Information label attached to the driver's doorjamb.

Label Example

| TIRE AND LOADING INFORMATION | | | |
|---|----------------|------------------------|--|
| SEATING CAPACITY | | TOTAL X FRONT X REAR X | |
| The combined weight of occupants and cargo should never exceed XXXkg or XXXlbs. | | | |
| TIRE | SIZE | COLD TIRE PRESSURE | SEE OWNER'S MANUAL FOR ADDITIONAL INFORMATION |
| FRONT | XXXX/XXXX XXXX | XXXKPA, XXPSI | |
| REAR | XXXX/XXXX XXXX | XXXKPA, XXPSI | |
| SPARE | XXXX/XXXX XXXX | XXXKPA, XXPSI | |

This figure includes the total weight of all occupants, cargo, and accessories, and the tongue load if you are towing a trailer.

⚠ WARNING

Overloading or improper loading can affect handling and stability and cause a crash in which you can be hurt or killed.

Follow all load limits and other loading guidelines in this manual.









Steps for Determining Correct Load Limit –

1. Locate the statement “The combined weight of occupants and cargo should never exceed XXX kg or XXX lbs.” on your vehicle's placard.
2. Determine the combined weight of the driver and passengers that will be riding in your vehicle.
3. Subtract the combined weight of the driver and passengers from XXX kg or XXX lbs.
4. The resulting figure equals the available amount of cargo and luggage load capacity. For example, if the “XXX” amount equals 1,400 lbs. and there will be five 150 lb. passengers in your vehicle, the amount of available cargo and luggage load capacity is 650 lbs.
(1,400 – 750 (5 × 150) = 650 lbs.)

CONTINUED

Carrying Cargo

5. Determine the combined weight of luggage and cargo being loaded on the vehicle. That weight may not safely exceed the available cargo and luggage load capacity calculated in Step 4.
6. If your vehicle will be towing a trailer, load from your trailer will be transferred to your vehicle. Consult this manual to determine how this reduces the available cargo and luggage load capacity of your vehicle.

| | | | |
|-----------|---|--|---|
| Example 1 | <p>Max Load</p>  <p>(870 lbs)</p> | <p>Passenger Weight</p> \geq  <p>(150 lbs x 2 = 300 lbs)</p> | <p>Cargo Weight</p>  <p>(570 lbs)</p> |
| Example 2 | <p>Max Load</p>  <p>(870 lbs)</p> | <p>Passenger Weight</p> \geq  <p>(150 lbs x 4 = 600 lbs)</p> | <p>Cargo Weight</p>  <p>(270 lbs)</p> |
| Example 3 | <p>Max Load</p>  <p>(870 lbs)</p> | <p>Passenger Weight</p> \geq  <p>(150 lbs x 5 = 750 lbs)</p> | <p>Cargo Weight</p>  <p>(120 lbs)</p> |

In addition, the total weight of the vehicle, all occupants, accessories, cargo, and trailer tongue load must not exceed the Gross Vehicle Weight Rating (GVWR) or the Gross Axle Weight Rating (GAWR). Both are on a label on the driver's doorjamb.

Carrying Cargo in the Passenger Compartment

- Store or secure all items that could be thrown around and hurt someone during a crash.
- Be sure items placed on the floor behind the front seats cannot roll underneath and interfere with the proper operation of the seats, the sensors under the seats, or the driver's ability to operate the pedals.

- If you fold the rear seats down, tie down items that could be thrown about the vehicle during a crash or sudden stop. Also, keep all cargo below the bottom of the windows. If it is higher, it could interfere with the proper operation of the side curtain airbags.
- Keep the glove box closed while driving. If it is open, a passenger could injure their knees during a crash or sudden stop.
- Do not put any items on top of the cargo area cover. They can block your view and be thrown around the vehicle during a crash.

Carrying Cargo in the Cargo Area or on a Roof Rack

- Distribute cargo evenly on the floor of the cargo area, placing the heaviest items on the bottom and as far forward as possible. Tie down items that could be thrown about the vehicle during a crash or sudden stop.
- If you fold the rear seats down, tie down items that could be thrown about the vehicle during a crash or sudden stop. Keep all cargo below the bottom of the windows. If it is higher, it could interfere with the proper operation of the side curtain airbags.

CONTINUED

Carrying Cargo

- If you carry large items that prevent you from closing the tailgate, exhaust gas can enter the passenger area. To avoid the possibility of **carbon monoxide poisoning**, follow the instructions on page 57.
- If you carry any items on a roof rack, be sure the total weight of the rack and the items does not exceed 110 lbs (50 kg).

If you use an accessory roof rack, the roof rack weight limit may be lower. Refer to the information that came with your roof rack.

Cargo Hooks/Hanger Bars

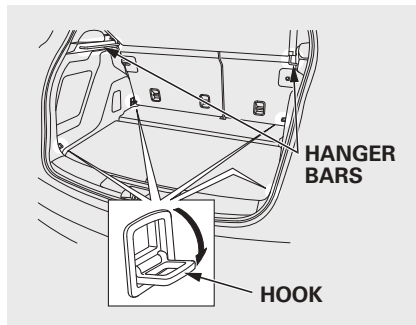

To secure the cargo, you can use the four cargo hooks in the cargo area. The illustration shows the location of each cargo hook.

The cargo hooks on the floor can be used to install the cargo net for securing items.

The hanger bars can be used to hang items. The hanger bar is designed to hang light items (maximum load: 11 lbs or 5 kg on each side). Heavy items may damage the bars.

Optional Cargo Net

The cargo net can be used to help hold down light items in the cargo area. The cargo net may not prevent heavy items from being thrown forward in a crash or a sudden stop. Heavy items should be secured to the cargo area floor with the hooks or cinch straps attached to the cargo hooks.

[Main Menu](#)

[Table of Contents](#)

This section gives you tips on starting the engine under various conditions, and how to operate the automatic transmission. It also includes important information on parking your vehicle, the braking system, the Super Handling-All Wheel Drive™ (SH-AWD®) system, the vehicle stability assist (VSA®) system, the tire pressure monitoring system (TPMS), and facts you need if you are planning to tow a trailer or drive off-highway.

| | |
|--|-----|
| Driving Guidelines..... | 372 |
| Preparing to Drive | 373 |
| Starting the Engine | 374 |
| Automatic Transmission | 376 |
| Driving with the Paddle Shifters | 380 |
| Super Handling-All Wheel Drive™ (SH-AWD®) System | 384 |
| Parking | 386 |
| Braking System | 387 |
| Anti-lock Brakes (ABS) | 388 |
| Tire Pressure Monitoring System (TPMS) | 390 |
| Vehicle Stability Assist (VSA®), aka Electronic Stability Control (ESC), System..... | 395 |
| Towing a Trailer..... | 397 |
| Off-Highway Driving Guidelines..... | 405 |

Driving Guidelines

Your vehicle has higher ground clearance that allows you to travel over bumps, obstacles, and rough terrain. It also provides good visibility so you can anticipate problems earlier.

Because your vehicle rides higher off the ground, it has a high center of gravity that can cause it to roll over if you make abrupt turns. Utility vehicles have a significantly higher roll over rate than other types of vehicles.

To prevent rollovers or loss of control:

- Take corners at slower speeds than you would with a passenger vehicle.
- Avoid sharp turns and abrupt maneuvers whenever possible.
- Do not modify your vehicle in any way that would raise the center of gravity.
- Do not carry heavy cargo on the roof.

Your vehicle is equipped with a super handling-all wheel drive (SH-AWD) system. When the system senses a loss of one or more wheel traction, it automatically transfers some power to the other wheels. This gives you better traction and mobility.

You still need to exercise the same care when accelerating, steering, and braking that you would in a two-wheel drive vehicle.

See page 405 for off-highway driving guidelines.

You should do these checks and adjustments before you drive your vehicle:

1. Make sure all windows, mirrors, and outside lights are clean and unobstructed. Remove frost, snow, or ice.
2. Check that the hood is fully closed.
3. Visually check the tires. If a tire looks low, use a gauge to check its pressure.
4. Check that any items you may be carrying are stored properly or fastened down securely.
5. Check the seat adjustment (see page [134](#)).
6. Check the adjustment of the inside and outside mirrors (see page [146](#)).
7. Check the steering wheel adjustment (see page [122](#)).
8. Make sure the doors and the tailgate are securely closed and locked.
9. Fasten your seat belt. Check that your passengers have fastened their seat belts (see page [15](#)).
10. When you start the engine, check the gauges and indicators in the instrument panel, and the messages on the multi-information display (see pages [63](#), [73](#) and [74](#)).

Starting the Engine

Your vehicle's starting system has an auto control mode. When you turn the ignition switch to the START (III) position, this feature keeps the engine's starter motor running until the engine starts. Follow these instructions to start the engine:

1. Apply the parking brake.
2. In cold weather, turn off all electrical accessories to reduce the drain on the battery.
3. Make sure the shift lever is in Park. Press on the brake pedal.
4. Without touching the accelerator pedal, turn the ignition key to the START (III) position. Do not hold the key in the START (III) position for more than 15 seconds at a time. If the engine does not start right away, pause for at least 10 seconds before trying again.

NOTICE

The immobilizer system protects your vehicle from theft. If an improperly coded key (or other device) is used, the engine's fuel system is disabled. For more information, see page 124.

NOTICE

The engine is harder to start in cold weather. Also, the thinner air found at altitudes above 8,000 feet (2,400 meters) adds to this problem.

Your vehicle has an electric vacuum pump located in the engine compartment. When you drive in cold weather or thinner air at high altitude, the electric vacuum pump operates more frequently after the engine is started.

When the electric vacuum pump is in operation, it makes some mechanical noises come from the engine compartment. This is normal.

Check Starter System Message



If there is a problem with the starter system, you will see a “CHECK STARTER SYSTEM” message on the multi-information display when the ignition switch is turned to the ON (II) position. You will also see this message when the auto control mode of the starter system has a problem.



If this message is on, the ignition switch has to be held in the START (III) position manually until the engine starts. The ignition switch can be held in that position up to 15 seconds.

Even though you may be able to start the engine manually without the auto control mode of the starter system, have your dealer inspect your vehicle.

Automatic Transmission

Shift Lever Position Indicators

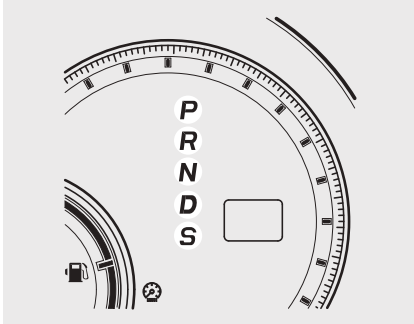

These indicators on the instrument panel show which position the shift lever is in.

The “D” indicator comes on for a few seconds when you turn the ignition switch to the ON (II) position. If it flashes while driving (in any shift position), it indicates a possible problem in the transmission.

If the malfunction indicator lamp comes on along with the “D” indicator, there is a problem with the automatic transmission control system. Avoid rapid acceleration, and have the transmission checked by your dealer as soon as possible.

When the “D” indicator warns of a possible problem with the transmission, you will see a “CHECK TRANSMISSION” message on the multi-information display (see page 80).

Shifting

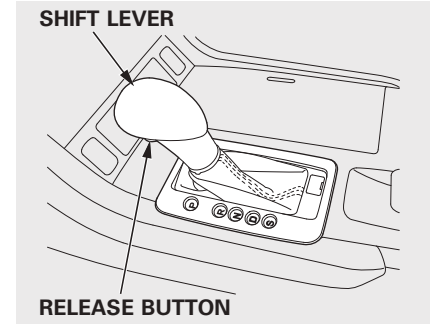

To shift from Park to any position, press firmly on the brake pedal and press the release button on the front of the shift lever, then pull the lever. You cannot shift out of Park when the ignition switch is in the LOCK (0) or the ACCESSORY (I) position.

| To shift from: | Do this: |
|--------------------------------------|--|
| P to R | Press the brake pedal, and press the shift lever release button. |
| R to P N to R D to S | Press the shift lever release button. |
| S to D D to N N to D R to N | Move the shift lever. |

Park (P) – This position mechanically locks the transmission. Use Park whenever you are turning off or starting the engine. To shift out of Park, you must press on the brake pedal and have your foot off the accelerator pedal. Press the release button on the front of the shift lever to move it.

If you have done all of the above and still cannot move the lever out of Park, see **Shift Lock Release** on page [379](#).

To avoid transmission damage, come to a complete stop before shifting into Park. You must also press the release button to shift into Park. The shift lever must be in Park before you can remove the key from the ignition switch.

Reverse (R) – Press the brake pedal and press the release button on the front of the shift lever to shift from Park to reverse. To shift from reverse to neutral, come to a complete stop, and then shift. Press the release button before shifting into reverse from neutral.

Neutral (N) – Use neutral if you need to restart a stalled engine, or if it is necessary to stop briefly with the engine idling. Shift to the Park position if you need to leave your vehicle for any reason. Press on the brake pedal when you are moving the shift lever from neutral to another gear.

CONTINUED

Automatic Transmission

Drive (D) – Use this position for your normal driving. The transmission automatically adjusts to keep the engine at the best speed for the driving conditions.

S Position(S) – To shift into the S position, press the release button on the front of the shift lever, and move the lever to S. This position is similar to D, except only gears from first to fourth are selected. The S position keeps the transmission from cycling between fourth and fifth gears in stop-and-go driving.

With the shift lever in D or S, you can also use the paddle shifters to shift the transmission up or down. Once you begin to use the paddle shifters in S, the transmission will no longer upshift or downshift automatically. For more information of driving with the paddle shifters, see page [380](#).

Engine Speed Limiter

If you exceed the maximum speed for the gear you are in, the engine speed will enter into the tachometer's red zone. If this occurs, you may feel the engine cut in and out. This is caused by a limiter in the engine's computer controls. The engine will run normally when you reduce the rpm below the red zone.

Shift Lock Release

This allows you to move the shift lever out of Park if the normal method of pushing on the brake pedal and pressing the release button does not work.

1. Set the parking brake.
2. Remove the key from the ignition switch.
3. Put a cloth on the notch of the shift lock release slot cover to prevent scratches. Using a small flat-tip screwdriver or a metal fingernail file, carefully pry on the notch of the cover to remove it.

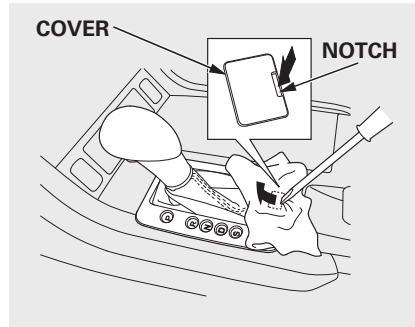

4. Insert the key in the shift lock release slot.
5. Push down on the key while you press the release button on the shift lever and move the shift lever out of Park to neutral.

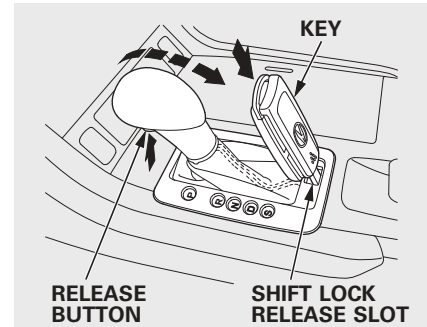

6. Remove the key from the shift lock release slot, then install the cover. Make sure the notch on the cover is on the rear. Insert the key back into the ignition switch, press the brake pedal, and restart the engine.

If you need to use the shift lock release, it means your vehicle is developing a problem. Have it checked by your dealer

Driving with the Paddle Shifters

Using the Paddle Shifters in the D position (D-Paddle Shift Mode)

When you are driving in the D position, pulling either paddle shifter switches from the ordinary automatic transmission [drive mode (D)] to the D-paddle shift mode. You can shift the transmission up or down manually with the paddle shifters.

Downshifting gives you more power when climbing, and provides engine braking when going down a steep hill.

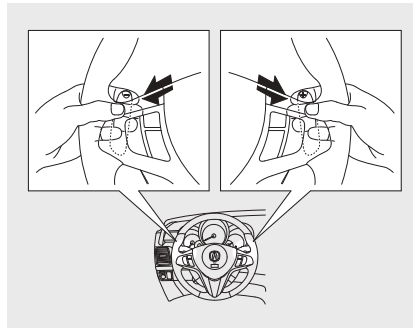

To shift up or down, use the + (right) or - (left) paddle shifter on either side of the steering wheel.

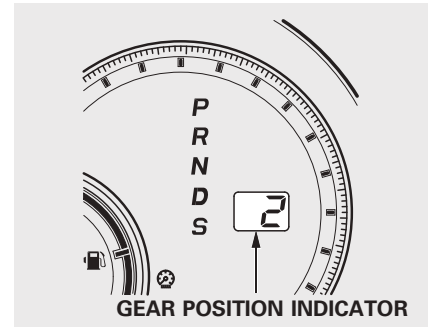

Each time you pull + (right), the transmission shifts to a higher gear. Pull - (left) to downshift. You will see the selected gear number on the instrument panel.

When you pull either paddle shifter, the gear position indicator shows you the selected gear number.

The transmission control system monitors the accelerator pedal use and your driving conditions. When you press the accelerator pedal as in normal driving, the system judges that you are driving at a constant cruising speed without using the paddle shifters. Under these conditions, D-paddle shift mode is canceled, and the transmission automatically returns to drive mode (D).

When the transmission returns to drive mode (D), the displayed gear number disappears.

The transmission remains in the selected gear if you do not accelerate.

Each time you pull either paddle shifter, the transmission shifts one gear up or down. If you want to shift up or down more than two gears, pull the paddle shifter twice, pause, and then pull it again.

The automatic transmission will not allow you to shift up or down if:

- You downshift before the engine speed reaches the highest threshold of the lower gear.

If you try to do this, the gear position indicator will flash the number of the lower gear several times, then return to a higher gear.

- You upshift before the engine speed reaches the lowest threshold of the higher gear.
- You pull both paddle shifters at the same time.
- You pull one of the two paddle shifters while continuously pulling on the other one.

The transmission downshifts to first gear and returns to drive mode (D) when the vehicle comes to a complete stop or the vehicle speed is about 6 mph (10 km/h).

If there is a problem in the transmission while you are driving with the paddle shifters, the D indicator flashes, the D-paddle shift mode is canceled, and the transmission returns to drive mode (D).

CONTINUED

Driving with the Paddle Shifters

Using the Paddle Shifters in the S position (Sequential Shift Mode)

With the shift lever in the S position, you can select the sequential shift mode to shift gears; much like a manual transmission using the paddle shifters, but without a clutch pedal.

To enter the sequential shift mode, press the release button on the front of the shift lever, move the lever to the S position, then pull either paddle shifter. To cancel the sequential shift mode and return to the ordinary automatic transmission, move the shift lever from the S position. When moving the shift lever, be careful not to operate incorrectly. While you are driving in the sequential shift mode, the transmission will not automatically return to ordinary automatic transmission.

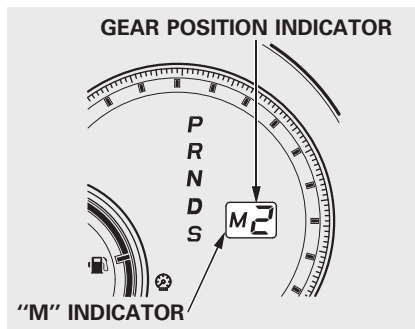

When you move the shift lever from “D” to “S” position and pull either paddle shifter, the gear position indicator displays “M” along with the selected gear number.

To upshift, pull the + (right) paddle shifter. To downshift, pull the – (left) paddle shifter.

When you accelerate from a stop, the transmission starts in first gear, and you must manually upshift between first and fifth gears. Make sure you upshift before the engine speed reaches the tachometer's red zone.

The transmission remains in the selected gear (5, 4, 3, 2, or 1). There is no automatic downshift when you push the accelerator pedal to the floor.

When you are driving in 4th or 5th gear, the transmission downshifts to the lower gear under the following conditions:

- The vehicle slows down to a certain speed.
- You press the brake pedal.

Downshifting with the paddle shifter allows you to increase the engine braking when going down steep or long hills, and provides more power when climbing uphill. You can upshift the transmission manually to reduce the rpm.

The transmission also shifts automatically as the vehicle comes to a complete stop. It downshifts to first gear when the vehicle speed reaches 6 mph (10 km/h) or less.

The automatic transmission will not allow you to shift up or down if:

- You downshift before the engine speed reaches the highest threshold of the lower gear.
If you try to do this, the gear position indicator will flash the number of the lower gear several times, then return to a higher gear.
- You upshift before the engine speed reaches the lowest threshold of the higher gear.
- You try to shift to third or a higher gear when the vehicle is stationary.
- You pull both paddle shifters at the same time.
- You pull one of the two paddle shifters while continuously pulling on the other one.

Here are the speed ranges for upshifting and downshifting.

| To shift from | Speed range |
|---------------|-----------------------|
| 1 → 2 | over 0 mph (0 km/h) |
| 2 → 3 | over 8 mph (13 km/h) |
| 3 → 4 | over 17 mph (27 km/h) |
| 4 → 5 | over 47 mph (75 km/h) |

| To shift from | Speed range |
|---------------|--------------------------|
| 2 → 1 | under 29 mph (47 km/h) |
| 3 → 2 | under 63 mph (100 km/h) |
| 4 → 3 | under 94 mph (150 km/h) |
| 5 → 4 | under 114 mph (182 km/h) |

CONTINUED

Driving with the Paddle Shifters, Super Handling-All Wheel Drive™ (SH-AWD®) System

Starting in Second Gear

When you are in sequential shift mode, and the vehicle is stopped, pull the + (right) paddle shifter to shift to second gear. You will see “M2” in the display. Starting in second gear helps to reduce wheelspin in deep snow or on a slippery surface.

Recommended Shift Points

Drive in the highest gear that lets the engine run and accelerate smoothly. This will give you good fuel economy and effective emissions control. The following shift points are recommended:

| Shift up | Normal acceleration |
|------------|---------------------|
| 1st to 2nd | 15 mph (24 km/h) |
| 2nd to 3rd | 25mph (40 km/h) |
| 3rd to 4th | 40 mph (64 km/h) |
| 4th to 5th | 47 mph (76 km/h) |

Super Handling-All Wheel Drive™ (SH-AWD®) System

If equipped

The super handling-all wheel drive (SH-AWD) system is a full time all-wheel-drive system that automatically controls and transfers varying amounts of engine torque to all wheels independently, according to the driving conditions.

While the SH-AWD system helps to enhance the vehicle's driving stability in all situations, it is still your responsibility to drive and corner at reasonable speeds and to leave a sufficient margin of safety.

SH-AWD Torque Distribution Monitor

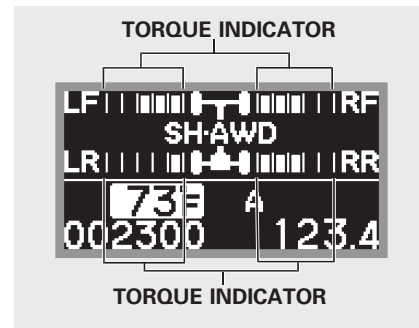

The SH-AWD torque distribution monitor on the multi-information display shows you the amount of torque being sent to the wheels. Each wheel — right front (RF), left front (LF), right rear (RR), and left rear (LR) — has its own torque indicator.

Super Handling-All Wheel Drive™ (SH-AWD®) System

Each torque indicator is displayed as a bar graph divided into 5 segments. The number of segments represents the amount of torque distributed to each wheel.

When there is only a slight change in torque distribution while driving, such as cruising on level roads at the same speed, the torque distribution monitor may stop displaying the amount of torque. This is not a system problem. The monitor will show the amount if the system senses any change in torque distribution.



If the SH-AWD indicator blinks while driving, it indicates the differential temperature is too high. You will also see an “SH-AWD DIFF TEMP HIGH” message on the multi-information display. If this happens, pull to the side of the road when it is safe, shift to Park, and let the engine idle until the indicator goes out. If the indicator does not go out, take your vehicle to a dealer to have it checked.



If the SH-AWD indicator on the instrument panel stays on, and the “CHECK SH-AWD SYSTEM” message also appears on the multi-information display, there is a problem with the SH-AWD system.

Your vehicle still has normal front-wheel drive with vehicle stability assist (VSA), but does not have the advantages of SH-AWD. Have your vehicle checked by a dealer as soon as possible.

Parking

Always use the parking brake when you park your vehicle. Make sure the parking brake is set firmly, or your vehicle may roll if it is parked on an incline.

Set the parking brake before you put the transmission in Park. This keeps the vehicle from moving and putting pressure on the parking mechanism in the transmission.

Parking Tips

- Make sure the moonroof and the windows are closed.
 - Turn off the lights.
 - Place any packages, valuables, etc. in the cargo area or take them with you.
 - Lock the doors and the tailgate.
 - Never park over dry leaves, tall grass, or other flammable materials. The hot three way catalytic converter could cause these materials to catch on fire.
- If the vehicle is facing uphill, turn the front wheels away from the curb.
 - If the vehicle is facing downhill, turn the front wheels toward the curb.
 - Check the indicator on the instrument panel to verify that the security system is set.
 - Make sure the parking brake is fully released before driving away. Driving with the parking brake partially set can overheat or damage the rear brakes.

Your vehicle is equipped with disc brakes at all four wheels. A power assist using negative pressure generated by the engine and the electric vacuum pump helps reduce the effort needed on the brake pedal. The anti-lock brake system (ABS) helps you retain steering control when braking very hard.

When the electric vacuum pump is in operation, it makes some mechanical noises come from the engine compartment. This is normal.

When you drive in cold weather or thinner air at high altitude, the electric vacuum pump operates more frequently after the engine is started.

For more information about the electric vacuum pump, see page [468](#).

Resting your foot on the pedal keeps the brakes applied lightly, builds up heat, and reduces their effectiveness and reduces brake pad life. In addition, fuel economy can be reduced. It also keeps your brake lights on all the time, confusing drivers behind you.

Constant application of the brakes when going down a long hill builds up heat and reduces their effectiveness. Use the engine to assist the brakes by taking your foot off the accelerator and downshifting to a lower gear.

Check your brakes after driving through deep water. Apply the brakes moderately to see if they feel normal. If not, apply them gently and frequently until they do. Be extra cautious and alert in your driving.

Braking System Design

The hydraulic system that operates the brakes has two separate circuits. Each circuit works diagonally across the vehicle (the left-front brake is connected with the right-rear brake, etc.). If one circuit should develop a problem, you will still have braking at two wheels.

Brake Pad Wear Indicators

All four brakes have audible brake wear indicators.

If the brake pads need replacing, you will hear a distinctive, metallic screeching sound when you apply the brake pedal. If you do not have the brake pads replaced, they will screech all the time. It is normal for the brakes to occasionally squeal or squeak when you apply them.

Anti-lock Brakes (ABS)

The anti-lock brake system (ABS) helps prevent the wheels from locking up, and helps you retain steering control by pumping the brakes rapidly, much faster than a person can do it.

The electronic brake distribution (EBD) system, which is part of the ABS, also balances the front-to-rear braking distribution according to vehicle loading.

You should never pump the brake pedal. Let the ABS work for you by always keeping firm, steady pressure on the brake pedal. This is sometimes referred to as “stomp and steer.”

You will feel a pulsation in the brake pedal when the ABS activates, and you may hear some noise. This is normal: it is the ABS rapidly pumping the brakes. On dry pavement, you will need to press on the brake pedal very hard before the ABS activates. However, you may feel the ABS activate immediately if you are trying to stop on snow or ice.



ABS Indicator

If this indicator comes on, the anti-lock function of the braking system has shut down. The brakes still work like a conventional system, but without anti-lock. You should have your dealer inspect your vehicle as soon as possible.

You will also see a “CHECK ABS SYSTEM” message on the multi-information display (see page [80](#)).

If the indicator comes on while driving, test the brakes as instructed on page [467](#).

If the ABS indicator and the brake system indicator come on together, and the parking brake is fully released, the EBD system may also be shut down.

Test your brakes as instructed on page 467. If the brakes feel normal, drive slowly and have your vehicle repaired by your dealer as soon as possible. Avoid sudden hard braking which could cause the rear wheels to lock up and possibly lead to a loss of control.

The VSA indicator will come on along with the ABS indicator.

Important Safety Reminders
ABS does not reduce the time or distance it takes to stop the vehicle. It only helps with the steering control during braking.

ABS will not prevent a skid that results from changing direction abruptly, such as trying to take a corner too fast or making a sudden lane change. Always drive at a safe speed for the road and weather conditions.

ABS cannot prevent a loss of stability. Always steer moderately when you are braking hard. Severe or sharp steering wheel movement can still cause your vehicle to veer into oncoming traffic or off the road.

A vehicle with ABS may require a longer distance to stop on loose or uneven surfaces, such as gravel or snow, than a vehicle without anti-lock.

Tire Pressure Monitoring System (TPMS)

Your vehicle is equipped with a tire pressure monitoring system (TPMS) that turns on every time you start the engine and monitors the pressure in your tires while driving.

Each tire has its own pressure sensor. If the air pressure of a tire becomes significantly low, the sensor in that tire immediately sends a signal that causes the low tire pressure/TPMS indicator in the instrument panel to come on. If this happens, you will see which tire is losing pressure on the multi-information display along with a “CHECK TIRE PRESSURE” message.



Low Tire Pressure/TPMS Indicator

When the low tire pressure/TPMS indicator is on, one or more of your tires is significantly underinflated. You should stop and check your tires as soon as possible, and inflate them to the proper pressure as indicated on the vehicle's tire information placard.

It is possible that the pressures shown on the multi-information display and the pressures you manually measure are slightly different.

If the difference is significant or you cannot make the low tire pressure/TPMS indicator and message on the multi-information display go out after inflating the tires to the specified values, have your dealer check the system as soon as possible.

If you think you can safely drive a short distance to a service station, proceed slowly to the station, then inflate the tire to the recommended pressure.

If the tire is flat, or if the tire pressure is too low to continue driving, replace the tire with the compact spare tire (see page [454](#)).

Driving on a significantly underinflated tire causes the tire to overheat and can lead to tire failure. Under-inflation also reduces fuel efficiency and tire tread life, and may affect the vehicle's handling and stopping ability.

Because tire pressure varies by temperature and other conditions, the low tire pressure/TPMS indicator may come on unexpectedly.

Tire Pressure Monitoring System (TPMS)

For example, if you check and fill your tires in a warm area, then drive in extremely cold weather, the tire pressure will be lower than measured and could be underinflated and cause the low tire pressure/TPMS indicator to come on. Or, if you check and adjust your tire pressure in cooler conditions, and drive into extremely hot conditions, the tire may become overinflated. However, the low tire pressure/TPMS indicator will not come on if the tires are overinflated.

Refer to page [444](#) for tire inflation guidelines.

If there is a problem with the TPMS, this indicator begins to flash. It stops flashing after approximately 1 minute, then stays on. You will also see a “CHECK TPMS SYSTEM” message on the multi-information display (see page [393](#)).

Although your tire pressure is monitored, you must manually check the tire pressures monthly.

Each tire, including the spare, should be checked monthly when the vehicle is cold, and set to the recommended inflation pressure as specified on the vehicle placard and in the owner's manual (see page [445](#)).

Tire Pressure Monitor

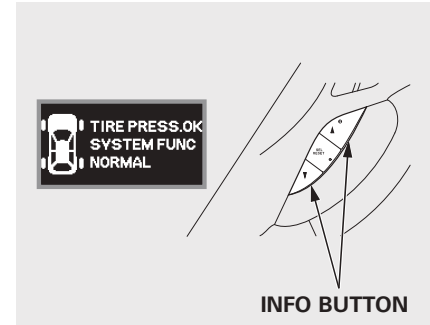

To select the tire pressure monitor, press the INFO button several times with the ignition switch in the ON (II) position.

You will see the above display on the multi-information display when all tire pressures are normal.

CONTINUED

Tire Pressure Monitoring System (TPMS)

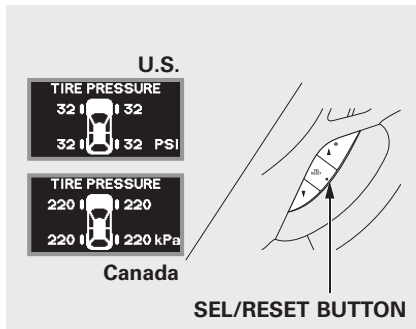

To see the inflation pressures of all four tires, press the SEL/RESET button. The display changes as shown above.

Each tire pressure is shown in PSI (U.S. models) or in kPa (Canadian models).



This shows that front left tire is losing pressure.

Each tire has its own pressure sensor. If the air pressure of a tire becomes significantly low, the sensor in that tire immediately sends a signal that causes the low tire pressure/TPMS indicator in the instrument panel to come on. If this happens, you will see which tire is losing pressure on the multi-information display along with a "CHECK TIRE PRESSURE" message.



When any of the tires have low pressure, the tire pressure monitor shows a "TIRE PRESS. ERROR SYSTEM FUNC NORMAL" message. When you continue driving after installing the spare tire, you will also see this message on the multi-information display.

Tire Pressure Monitoring System (TPMS)



If there is a problem with the TPMS, the tire pressure monitor shows a “SYSTEM FUNCTION ERROR” message and the tire pressure readings are not displayed. If this happens, you will first see a system warning message “CHECK TPMS SYSTEM” on the multi-information display.

TPMS System Failure

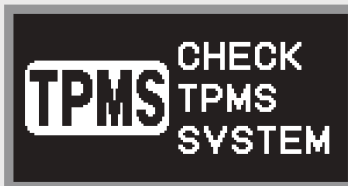

If there is a problem with the TPMS, you will see the above message on the multi-information display.

If you see this message, the system is off and is not monitoring the tire pressures. Have the system checked by your dealer as soon as possible.

Also, the low tire pressure/TPMS indicator begins to flash (see page 71).

If the low tire pressure/TPMS indicator comes on, or the multi-information display shows a “CHECK TPMS SYSTEM” message, the VSA system automatically turns on even when the VSA system is turned off by pressing the VSA OFF switch (see page 396). If this happens, you cannot turn the VSA system off by pressing the VSA OFF switch again.

When you restart the vehicle with the compact spare tire, the TPMS system message will also be displayed on the multi-information display after several miles (kilometers) driving.

CONTINUED

Tire Pressure Monitoring System (TPMS)

Changing a Tire with TPMS

If you have a flat tire, the low tire pressure/TPMS and tire monitor indicators will come on. Replace the indicated flat tire with the compact spare tire (see page 454).

After the flat tire is replaced with the spare tire, the low tire pressure/TPMS indicator stays on while driving. After several miles (kilometers) driving, this indicator begins to flash, then stays on again. You will also see a “CHECK TPMS SYSTEM” message on the multi-information display. This is normal; the system cannot monitor the spare tire pressure. Manually check the spare tire pressure to be sure it is correct.

This indicator and the warning message on the multi-information display will go off, after several miles (kilometers) driving, when the spare tire is replaced with the specified regular tire equipped with the tire pressure monitor sensor.

Each wheel is equipped with a tire pressure sensor mounted inside the tire behind the valve stem. You must use TPMS specific wheels. It is recommended that you always have your tires serviced by your dealer or a qualified technician.

Never use a puncture-repairing agent in a flat tire. If used, you will have to replace the tire pressure sensor. Have the flat tire repaired by your dealer as soon as possible.

As required by the FCC:

This device complies with Part 15 of the FCC rules. Operation is subject to the following two conditions: (1) This device may not cause harmful interference, and (2) this device must accept any interference received, including interference that may cause undesired operation.

Changes or modifications not expressly approved by the party responsible for compliance could void the user's authority to operate the equipment.

This device complies with Industry Canada Standard RSS-210.

Operation is subject to the following two conditions: (1) this device may not cause interference, and (2) this device must accept any interference that may cause undesired operation of the device.

Vehicle Stability Assist (VSA®), aka Electronic Stability Control (ESC), System

The vehicle stability assist (VSA) system helps to stabilize the vehicle during cornering if the vehicle turns more or less than desired. It also assists you in maintaining traction while accelerating on loose or slippery road surfaces. It does this by regulating the engine's output and by selectively applying the brakes.

When VSA activates, you may notice that the engine does not respond to the accelerator in the same way it does at other times. There may also be some noise from the VSA hydraulic system. You will also see the VSA activation indicator blink.

The VSA system cannot enhance the vehicle's driving stability in all situations and does not control your vehicle's entire braking system. It is still your responsibility to drive and corner at reasonable speeds and to leave a sufficient margin of safety.



VSA Activation Indicator

When VSA activates, you will see the VSA activation indicator blink (see page 69).



Vehicle Stability Assist (VSA) System Indicator

If this indicator comes on while driving, pull to the side of the road when it is safe, and turn off the engine. Reset the system by restarting the engine. If the VSA system indicator stays on or comes back on while driving, have the VSA system inspected by your dealer.

NOTE: The main function of the VSA system is generally known as Electronic Stability Control (ESC). The system also includes a traction control function.

If the indicator does not come on when the ignition switch is turned to the ON (II) position, there may be a problem with the VSA system. Have your dealer inspect your vehicle as soon as possible.

You will also see a "CHECK VSA SYSTEM" message on the multi-information display if there is a problem with the VSA system.

If the low tire pressure/TPMS indicator comes on (see page 390), or the multi-information display shows a "CHECK TPMS SYSTEM" message with the indicator flashing (see page 393), the VSA system automatically turns on even if the VSA system is turned off with the VSA OFF switch. In this case, you cannot turn the VSA system off by pressing the VSA OFF switch again.

CONTINUED

Vehicle Stability Assist (VSA®), aka Electronic Stability Control (ESC), System

Without VSA, your vehicle will have normal braking and cornering ability, but it will not have VSA traction and stability enhancement.

VSA OFF Switch

In certain unusual conditions when your vehicle gets stuck in shallow mud or fresh snow, it may be easier to free it with the VSA temporarily switched off. When the VSA system is off, the traction control system is also off. You should only attempt to free your vehicle with the VSA off if you are not able to free it when the VSA is on.

Immediately after freeing your vehicle, be sure to switch the VSA on again. We do not recommend driving your vehicle with the VSA and traction control systems switched off.

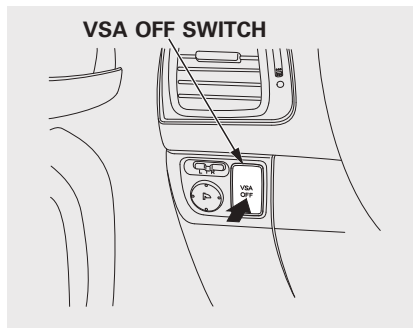

This switch is under the driver's side vent. To turn the VSA system on and off, press and hold it until you hear a beep.

When VSA is off, the VSA activation indicator comes on as a reminder. Press and hold the switch again. It turns the system back on.

VSA is turned on every time you start the engine, even if you turned it off the last time you drove the vehicle.

VSA and Tire Sizes

Driving with varying tire or wheel sizes may cause the VSA to malfunction. When replacing tires, make sure they are the same size and type as your original tires (see page 448).

If you install winter tires, make sure they are the same size as those that were originally supplied with your vehicle. Exercise the same caution during winter driving as you would if your vehicle was not equipped with VSA.

Your vehicle has been designed primarily to carry passengers and their cargo. You can also use it to tow a trailer if you carefully observe the load limits, use the proper equipment, and follow the guidelines in this section.

Break-In Period

Avoid towing a trailer during your vehicle's first 600 miles (1,000 km) (see page 352).

Be sure to read the **Off-Highway Driving Guidelines** section on page 405 if you plan to tow off paved surfaces.

⚠ WARNING

Exceeding any load limit or improperly loading your vehicle and trailer can cause a crash in which you can be seriously hurt or killed.

Check the loading of your vehicle and trailer carefully before starting to drive.

Load Limits

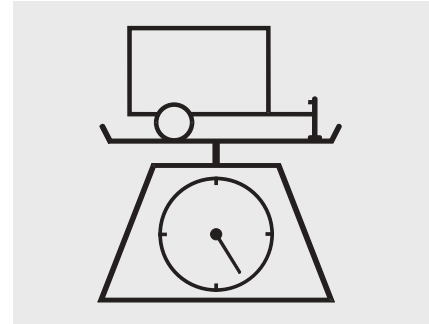

Total Trailer Weight: The maximum allowable weight of the trailer and everything in or on it must not exceed 1,500 lbs (680 kg). Towing a load that is too heavy can seriously affect your vehicle's handling and performance. It can also damage the engine and drivetrain.

CONTINUED

Towing a Trailer

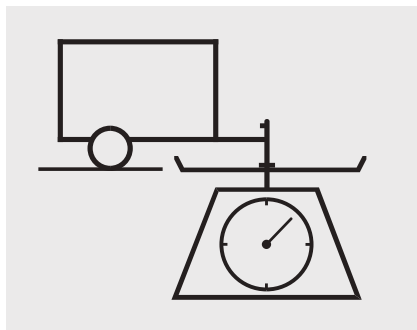

Tongue Load: The weight that the tongue of a fully-loaded trailer puts on the hitch should be approximately 10% of the total trailer weight. Too much tongue load reduces front-tire traction and steering control. Too little tongue load can make the trailer unstable and cause it to sway.

To achieve a proper tongue load, start by loading 60% of the load toward the front of the trailer and 40% toward the rear, then re-adjust the load as needed.

Gross Vehicle Weight Rating (GVWR) – The maximum allowable weight of the vehicle, all occupants, all accessories, all cargo, and the tongue load is :

4WD:

4,894 lbs (2,220 kg)

2WD:

4,718 lbs (2,140 kg)

Gross Axle Weight Ratings (GAWR) – The maximum allowable weight of the vehicle axle is :

4WD:

2,546 lbs (1,155 kg)

on the front axle

2,381 lbs (1,080 kg)

on the rear axle

2WD:

2,447 lbs (1,110 kg)

on the front axle

2,271 lbs (1,030 kg)

on the rear axle

Gross Combined Weight Rating (GCWR) – The maximum allowable weight of the fully loaded vehicle and trailer is :

4WD:

6,394 lbs (2,900 kg)

2WD:

4,718 lbs (2,140 kg)

Checking Loads

The best way to confirm that all loads are within limits is to check them at a public scale. For public scales in your area, check your local phone book, or contact your trailer dealer or rental agency for assistance.

If you cannot get to a public scale, you can estimate the total trailer weight by adding the weight of your trailer (as quoted by the manufacturer) with everything in or on the trailer.

If you normally pull the same load each time you tow a trailer, you can use a suitable scale or a special tongue load gauge to check the tongue load the first time you set up a towing combination (a fully loaded vehicle and trailer), then recheck the tongue load whenever the conditions change.

Towing Equipment and Accessories

Towing can require a variety of equipment, depending on the size of your trailer, how it will be used, how much load you are towing, and where you tow.

Discuss your needs with your trailer sales or rental agency, and follow the guidelines in this section. Also make sure that all equipment is properly installed and maintained, and that it meets federal, state, provincial, territorial and local regulations.

Hitches

Any hitch used on your vehicle must be properly bolted to the underbody.

Safety Chains

Always use safety chains when you tow a trailer. Make sure the chains are secured to the trailer and hitch, and that they cross under the tongue and can catch the trailer if it becomes unhitched. Leave enough slack to allow the trailer to turn corners easily, but do not let the chains drag on the ground.

CONTINUED

Towing a Trailer

Trailer Brakes

Acura recommends that any trailer with a total trailer weight of 1,000 lbs (450 kg) or more has its own brakes.

There are two common types of trailer brakes: surge and electric. Surge brakes are common for boat trailers, since the brakes will get wet.

If you choose electric brakes, be sure they are electronically actuated. Do not attempt to tap into your vehicle's hydraulic system. No matter how successful it may seem, any attempt to attach trailer brakes to your vehicle's hydraulic system will lower braking effectiveness and create a potential hazard.

See your trailer dealer or rental agency for more information on installing electric brakes.

Trailer Lights

Trailer lights and equipment must comply with federal, provincial, territorial, and local regulations. Check with your local trailer sales or rental agencies for the requirements in the area where you plan to tow, and use only equipment designed for your vehicle.

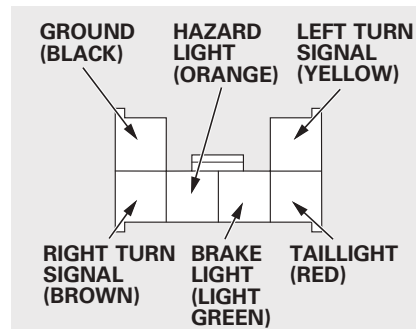

Your vehicle has a trailer lighting connector located under the right side tool case in the cargo area. Refer to the drawing above for the wiring color code and purpose of each pin.

Since lighting and wiring vary by trailer type and brand, you should have a qualified technician install a suitable connector between the vehicle and the trailer. Improper equipment or installation can cause damage to your vehicle's electrical system and affect your vehicle warranty.

Additional Towing Equipment

Many states, Canadian provinces and territories require special outside mirrors when towing a trailer. Even if they don't, you should install special mirrors if you cannot clearly see behind you, or if the trailer creates a blind spot.

Ask your trailer sales or rental agency if any other items are recommended or required for your towing situation.

Pre-Tow Checklist

When preparing to tow, and before driving away, be sure to check the following:

- The vehicle has been properly serviced, and the suspension, cooling system, and lights are in good operating condition.

CONTINUED

Towing a Trailer

- The trailer has been properly serviced and is in good condition.
- All weights and loads are within limits.
- The hitch, safety chains, and any other attachments are secure.
- All items in or on the trailer are properly secured and cannot shift while you drive.

- The lights and brakes on your vehicle and the trailer are working properly.
- Your vehicle tires and spare are properly inflated, and the trailer tires and spare are inflated as recommended by the trailer maker.

Driving Safely With a Trailer

The added weight, length, and height of a trailer will affect your vehicle's handling and performance, so driving with a trailer requires some special driving skills and techniques.

For your safety and the safety of others, take time to practice driving maneuvers before heading for the open road, and follow the guidelines in this section.

Towing Speeds and Gears

Drive slower than normal in all driving situations, and obey posted speed limits for vehicles with trailers. Use the D position when towing a trailer on level roads. See “***Driving on Hills***” in the next column for additional gear information. Do not exceed 55 mph (88 km/h). At higher speeds, the trailer may sway or affect vehicle handling.

When driving uphill and downhill, use the S position (without using the paddle shifters) to provide the proper engine power and engine braking on each gear. You can also use the paddle shifters. In this case, select third, second, or first gear with the paddle shifter; depending on the vehicle speeds and road condition. Do not use fourth and fifth gears. The recommended speed range for each gear position is shown in the table.

| Gear position | Speed range |
|---------------|------------------------------|
| 1 | 0 - 38 mph 0 - 60 km/h |
| 2, 3 | 19 - 62 mph 30 - 100 km/h |

Making Turns and Braking

Make turns more slowly and wider than normal. The trailer tracks a smaller arc than your vehicle, and it can hit or run over something the vehicle misses. Allow more time and distance for braking. Do not brake or turn suddenly as this could cause the trailer to jackknife or turn over.

CONTINUED

Towing a Trailer

Driving on Hills

When climbing hills, closely watch your temperature gauge (see page 78). If it nears the H (Hot) mark, turn the A/C off, reduce speed and, if necessary, pull to the side of the road to let the engine cool.

When driving down hills, reduce your speed, and shift down to S position, or use the paddle shifters to the lower gear (3, 2 or 1) in the S position. When towing a trailer, do not “ride” the brakes, and remember, it will take longer to slow down and stop when towing a trailer.

If you must stop when facing uphill, use the foot brake or parking brake. Do not try to hold the vehicle in place by pressing on the accelerator, as this can cause the automatic transmission to overheat.

Handling Crosswinds and Buffeting

Crosswinds and air turbulence caused by passing trucks can disrupt your steering and cause the trailer to sway. When being passed by a large vehicle, keep a constant speed, and steer straight ahead. Do not try to make quick steering or braking corrections.

Backing Up

Always drive slowly and have someone guide you when backing up. Grip the *bottom* of the steering wheel; then turn the wheel to the left to get the trailer to move to the left, and turn the wheel right to move the trailer to the right.

Parking

Follow all normal precautions when parking, including putting the transmission in Park and firmly setting the parking brake. Also, place wheel chocks at each of the trailer's tires.

Towing Your Vehicle

Your vehicle is not designed to be towed behind a motor home. If your vehicle needs to be towed in an emergency, see page 475.

General Information

Your vehicle has been designed primarily for use on pavement. But its higher ground clearance and super handling-all wheel drive (SH-AWD) system allow you to occasionally travel on unpaved roads, to campgrounds, picnic sites, and similar locations. It is not designed for trailblazing, mountain climbing, or other challenging off-road activities.

If you decide to drive on unpaved roads, you will find that it requires somewhat different driving skills. Your vehicle will also handle somewhat differently than it does on pavement. So be sure to read this owner's manual, pay special attention to the precautions and tips in this section, and get acquainted with your vehicle before you leave the pavement.

▲ WARNING

Improperly operating this vehicle on or off pavement can cause an accident or rollover in which you and your passengers could be seriously injured or killed.

- Follow all instructions and guidelines in this owner's manual.
- Keep your speed low, and don't drive faster than conditions permit.

Important Safety Precautions

To avoid loss of control or rollover, be sure to follow all precautions and recommendations.

- Be sure to store cargo properly, and do not exceed your vehicle cargo load limits (see pages 365 and 397).
- Wherever you drive, make sure you and your passengers always wear seat belts.
- Keep your speed low, and never go faster than the conditions allow.
- It's up to you to continually assess the situation and drive within the limits.

CONTINUED

Off-Highway Driving Guidelines

Check Out Your Vehicle

Before you leave the pavement, be sure to do all scheduled maintenance and service, and inspect your vehicle for any problems. Pay special attention to the condition of the tires, and check the tire pressures.

After you return to the pavement, carefully inspect your vehicle to make sure there is no damage that could make driving it unsafe. Recheck the condition of the tires and the tire pressures.

Remember

The route presents limits (too steep or bumpy roads). You have limits (driving skill and comfort). And your vehicle has limits (traction, stability, and power).

Driving off-highway can be hazardous if you fail to recognize limits and take the proper precautions.

Accelerating and Braking

For better traction on all surfaces, accelerate slowly and gradually build up speed. If you try to start too fast on wet soil, mud, snow, or ice, you might not have enough traction to get underway, and you may dig yourself a hole. Starting with the shift lever in D position will help you have a smoother start on snow or ice.

Keep in mind that you will usually need more time and distance to brake to a stop on unpaved surfaces. Avoid hard braking. Do not “pump” the brakes; let the anti-lock braking system pump them for you.

Avoiding Obstacles

Debris in the road can damage your suspension or other components. Because your vehicle has a high center of gravity, driving over a large obstacle, or allowing a wheel to drop into a deep hole can cause your vehicle to tip or roll over.

Driving on Slopes

If you can't clearly see all conditions or obstacles on a slope, walk the slope before you drive on it. If you have any doubt whether or not you can safely drive on the slope, don't do it. Find another route.

If you are driving up a hill and find that you cannot continue, *do not try to turn around*. Your vehicle could roll over. Slowly back down the hill, following the same route you took up the hill.

Crossing a Stream

Avoid driving through deep water. If you encounter water in your route (a small stream or large puddle, for example), evaluate it carefully before going ahead. Make sure it is shallow, flowing slowly, and has firm ground underneath. If you are not sure of the depth or the ground, turn around and find another route.

Driving through deep water can also damage your vehicle. The water can get into the transmission and differential, diluting the lubricant and causing an eventual failure. It can also wash the grease out of the wheel bearings.

If You Get Stuck

Avoid driving on soft sand, deep mud, or other surfaces where you could get stuck. If you do happen to get stuck because of inclement weather or other conditions, choose a safe and appropriate course of action.

You should never use a jack to try getting unstuck. A jack only works on firm, level ground. Also, your vehicle could easily slip off the jack and hurt you or someone else.

If you spin the wheels excessively trying to get unstuck, you may overheat the components of the SH-AWD system. The SH-AWD indicator on the instrument panel will blink to indicate the rear differential temperature is too high.

You will also see an “SH-AWD DIFF TEMP. HIGH” message on the multi-information display (see page 80).

If this happens, stop and allow everything to cool down. The SH-AWD indicator goes off after the rear differential temperature drops.

[Main Menu](#)

[Table of Contents](#)

This section explains why it is important to keep your vehicle well maintained and how to follow basic maintenance safety precautions.

This section also includes instructions on how to read the maintenance minder messages on the multi-information display, and instructions for simple maintenance tasks you may want to take care of yourself.

If you have the skills and tools to perform more complex maintenance tasks on your vehicle, you may want to purchase the service manual. See page 497 for information on how to obtain a copy, or see your dealer.

| | |
|---|-----|
| Maintenance Safety..... | 410 |
| Maintenance Minder | 411 |
| Fluid Locations | 419 |
| Adding Engine Oil | 420 |
| Required Engine Oil | 420 |
| Changing the Engine Oil and Filter | 422 |
| Engine Coolant | 424 |
| Windshield Washers..... | 426 |
| Automatic Transmission Fluid | 427 |
| Brake Fluid | 429 |
| Power Steering Fluid | 430 |
| Lights..... | 431 |
| Cleaning the Seat Belts | 438 |
| Floor Mats | 438 |
| Audio Antenna | 439 |
| Intercooler | 439 |
| Dust and Pollen Filter | 439 |
| Wiper Blades | 440 |
| Wheels..... | 443 |
| Tires | 444 |
| Checking the Battery | 450 |
| Vehicle Storage..... | 452 |

Maintenance Safety

All service items not detailed in this section should be performed by a certified technician or other qualified mechanic.

Important Safety Precautions

To eliminate potential hazards, read the instructions before you begin, and make sure you have the tools and skills required.

- Make sure your vehicle is parked on level ground, the parking brake is set, and the engine is off.
- To clean parts, use a commercially available degreaser or parts cleaner, not gasoline.
- To reduce the possibility of fire or explosion, keep cigarettes, sparks, and flames away from the battery and all fuel-related parts.
- Wear eye protection and protective clothing when working with the battery or compressed air.

⚠ WARNING

Improperly maintaining this vehicle, or failing to correct a problem before driving can cause a crash in which you can be seriously hurt or killed.

Always follow the inspection and maintenance recommendations and schedules in this owner's manual.

Potential Vehicle Hazards

- **Carbon Monoxide poison from engine exhaust.** Be sure there is adequate ventilation whenever you operate the engine.
- **Burns from hot parts.** Let the engine and exhaust system cool down before touching any parts.

- **Injury from moving parts.** Do not run the engine unless instructed to do so.

⚠ WARNING

Failure to properly follow maintenance instructions and precautions can cause you to be seriously hurt or killed.

Always follow the procedures and precautions in this owner's manual.

Some of the most important safety precautions are given here. However, we cannot warn you of every conceivable hazard that can arise in performing maintenance. Only you can decide whether or not you should perform a given task.

One of the most convenient and important features of the multi-information display on your vehicle is the maintenance minder.

Based on engine operating conditions and accumulated engine revolutions, the onboard computer in your vehicle calculates the remaining engine oil life and displays it as a percentage.

The system also displays the code for other scheduled maintenance items needing service.

Engine Oil Life

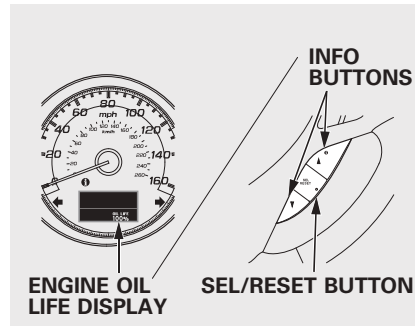

To see the current engine oil life displayed on the multi-information display, turn the ignition switch to the ON (II) position, and press the SEL/RESET button on the steering wheel repeatedly until the engine oil life is displayed.

The remaining engine oil life is shown on the display according to this table:

| Calculated Engine Oil Life (%) | Displayed Engine Oil Life (%) |
|--------------------------------|-------------------------------|
| 100 – 91% | 100% |
| 90 – 81% | 90% |
| 80 – 71% | 80% |
| 70 – 61% | 70% |
| 60 – 51% | 60% |
| 50 – 41% | 50% |
| 40 – 31% | 40% |
| 30 – 21% | 30% |
| 20 – 16% | 20% |
| 15 – 11% | 15% |
| 10 – 6% | 10% |
| 5 – 1% | 5% |
| 0% | 0% |

CONTINUED

Maintenance Minder

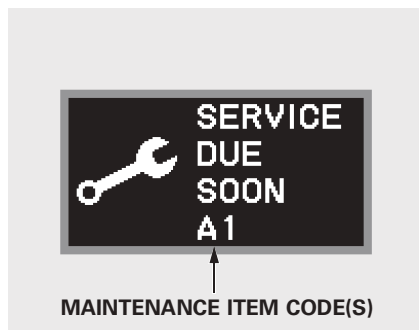

When the remaining engine oil life is 15 to 6 percent, the multi-information display shows a “SERVICE DUE SOON” message along with the maintenance schedule code indicating the main and sub items required at the time of the oil change. Refer to page 418 for a complete list of the maintenance main items and sub items.



When the remaining oil life is 5 to 1 percent, the multi-information display shows a “SERVICE DUE NOW” message with the same maintenance items “SERVICE DUE SOON” was displayed with. When you see this message have the indicated maintenance performed as soon as possible.

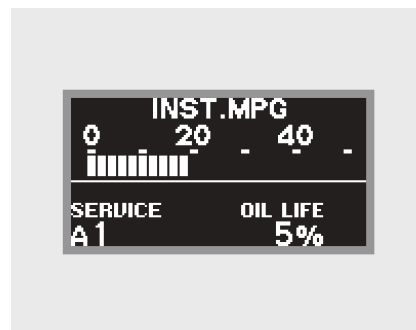

Press the SEL/RESET button on the steering wheel repeatedly to select the engine oil life. The message “SERVICE”, along with “5%”, and the maintenance item code are displayed on the lower part of the multi-information display when the calculated engine oil life is 1 – 5 percent (see page 411).



If the indicated maintenance service is not done and the remaining engine oil life reaches 0%, the multi-information display will show the message “SERVICE PAST DUE” and the maintenance item code(s). This message is displayed when the total distance traveled is less than 10 miles (for U.S. models) or 10 km (for Canadian models) after the engine oil life became 0%.

These messages will come on every time you turn the ignition switch to the ON (II) position.

Immediately have the service performed, and make sure to reset the oil life minder as previously described.

The message will be canceled if the ▼ or ▲ button on the steering wheel is pressed. Press the ▼ or ▲ button to see the message again.

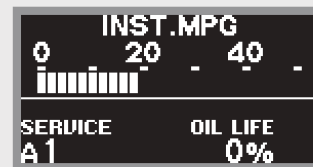

Press the SEL/RESET button on the steering wheel repeatedly to select the engine oil life. The message “SERVICE”, along with “0%”, and the maintenance item code are displayed on the lower part of the multi-information display when the calculated engine oil life is 0 – 1%.

CONTINUED

Maintenance Minder

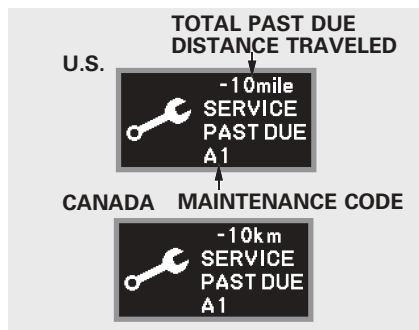

If the indicated required service is not done and the remaining engine oil life becomes 0%, the multi-information display will show a “SERVICE PAST DUE” message, the total distance traveled after the remaining oil life became 0%, and the maintenance item code(s).

This message is displayed again when you drive over 10 miles (for U. S. models) or 10 km (for Canadian models) after seeing the 0% message.

Immediately have the service performed, and make sure to reset the display as previously described.

The message will be canceled if the ▼ or ▲ button on the steering wheel is pressed. Press the ▼ or ▲ button to see the message again.

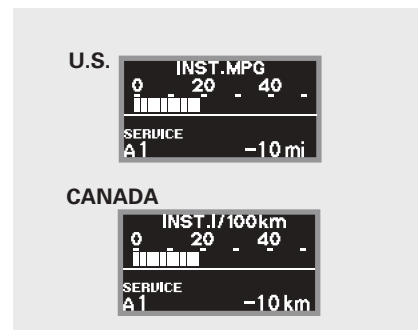

When you press the SEL/RESET button to select the engine oil life, the message “SERVICE”, along with the maintenance item code and the total negative distance traveled after the oil life became 0%, will be displayed on the lower part of the multi-information display.

Maintenance Main Items and Sub Items

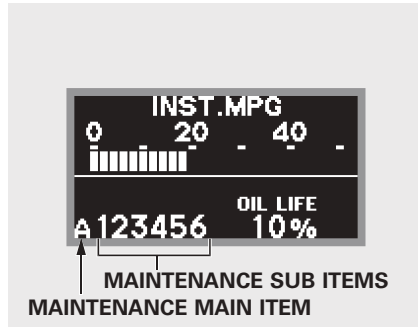

All the maintenance items displayed on the multi-information display are in code.

For an explanation of the maintenance codes, see page [418](#).

Resetting the Engine Oil Life Display

Your dealer will reset the display after completing the required maintenance service. You will see “OIL LIFE 100%” on the display the next time you turn the ignition switch to the ON (II) position.

If maintenance service is done by someone other than your dealer, reset the maintenance minder as follows:

1. Turn the ignition switch to the ON (II) position.
2. Press the SEL/RESET button on the steering wheel until you see the engine oil life display.

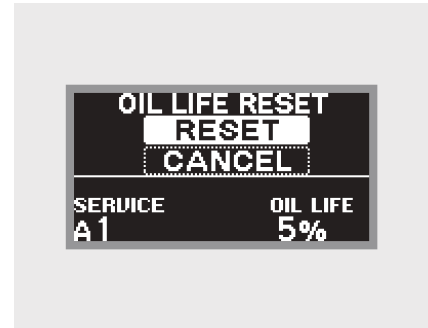

3. Press and hold the SEL/RESET button on the steering wheel for more than 10 seconds. The remaining engine oil life reset mode will be shown on the multi-information display.

CONTINUED

Maintenance Minder

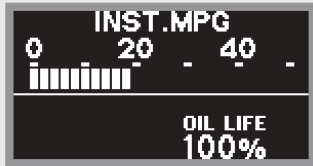

4. Select “RESET” by pressing the INFO (▼/▲) button, then press the SEL/RESET button to reset the engine oil life display. The maintenance item code(s) will disappear, and the engine oil life will reset to “100.” If you want to cancel the oil life reset mode, select “CANCEL.”

Important Maintenance Precautions

If you have the required service done but do not reset the display, or reset the display without doing the service, the system will not show the proper maintenance intervals. This can lead to serious mechanical problems because you will no longer have an accurate record of when maintenance is needed.

Your authorized dealer knows your vehicle best and can provide competent, efficient service. However, service at a dealer is not mandatory to keep your warranties in effect. Maintenance may be done by any qualified service facility or person who is skilled in this type of automotive service. Keep all receipts as proof of completion, and have the person who does the work fill out your Maintenance Journal or Canadian Maintenance Log. Check your warranty booklet for more information.

We recommend using Acura parts and fluids whenever you have maintenance done. These are manufactured to the same high-quality standards as the original components, so you can be confident of their performance and durability.

U.S. Vehicles: **Maintenance, replacement, or repair of emissions control devices and systems may be done by any automotive repair establishment or individual using parts that are “certified” to EPA standards.**

According to state and federal regulations, failure to perform maintenance on the items marked with # will not void your emissions warranties. However, Acura recommends that all maintenance services be performed in accordance with the intervals indicated by the multi-information display.

Owner's Maintenance Checks

You should check the following items at the specified intervals. If you are unsure of how to perform any check, turn to the appropriate page listed.

- Engine oil level – Check every time you fill the fuel tank. See page [356](#).
- Engine coolant level – Check the radiator reserve tank every time you fill the fuel tank. See page [357](#).
- Automatic transmission – Check the fluid level monthly. See page [427](#).
- Brakes – Check the fluid level monthly. See page [429](#).
- Tires – Check the tire pressure monthly. Examine the tread for wear and foreign objects. See page [445](#).
- Lights – Check the operation of the headlights, parking lights, taillights, high-mount brake light, and license plate lights monthly. See page [431](#).

Maintenance Minder

| Symbol | Maintenance Main Items |
|--------|---|
| A | <ul style="list-style-type: none"> ● Replace engine oil*¹ |
| B | <ul style="list-style-type: none"> ● Replace engine oil*¹ and oil filter ● Inspect front and rear brakes ● Check parking brake adjustment ● Inspect these items: <ul style="list-style-type: none"> ● Tie rod ends, steering gear box, and boots ● Suspension components ● Driveshaft boots ● Brake hoses and lines (including ABS/VSA) ● All fluid levels and condition of fluids ● Exhaust system[#] ● Fuel lines and connections[#] |

* 1: If the message "SERVICE" does not appear more than 12 months after the display is reset, change the engine oil every year.

#: See information on maintenance and emissions warranty on page 417.

NOTE: ● Independent of maintenance message in the information display, replace the brake fluid every 3 years.

- Inspect idle speed every 160,000 miles (256,000 km).
- Adjust the valves during services A, B, 1, 2, or 3 only if they are noisy.

| Symbol | Maintenance Sub Items |
|--------|---|
| 1 | <ul style="list-style-type: none"> ● Rotate tires |
| 2 | <ul style="list-style-type: none"> ● Replace air cleaner element If you drive in dusty conditions, replace every 15,000 miles (24,000 km). ● Replace dust and pollen filter If you drive primarily in urban areas that have high concentrations of soot in the air from industry and from diesel-powered vehicles, replace every 15,000 miles (24,000 km). ● Inspect drive belt |
| 3 | <ul style="list-style-type: none"> ● Replace transmission and transfer fluid Driving in mountainous areas at very low vehicle speeds or trailer towing results in higher transmission and transfer temperatures. This requires transmission and transfer fluid changes more frequently than recommended by the Maintenance Minder. If you regularly drive your vehicle under these conditions, have the transmission and transfer fluid changed at 60,000 miles (100,000 km), then every 30,000 miles (48,000 km). |
| 4 | <ul style="list-style-type: none"> ● Replace spark plugs ● Inspect valve clearance |
| 5 | <ul style="list-style-type: none"> ● Replace engine coolant |
| 6 | <ul style="list-style-type: none"> ● Replace rear differential fluid Driving in mountainous areas at very low vehicle speeds or trailer towing results in higher level of mechanical (shear) stress to fluid. This requires differential fluid changes more frequently than recommended by the Maintenance Minder. If you regularly drive your vehicle under these conditions, have the differential fluid changed at 7,500 miles (12,000 km), then every 15,000 miles (24,000 km). |

Fluid Locations

ENGINE OIL
DIPSTICK
(Orange loop)

WASHER FLUID
(Blue cap)

ENGINE OIL
FILL CAP

POWER STEERING
FLUID
(Red cap)

ENGINE
COOLANT
RESERVOIR

RADIATOR CAP

BRAKE FLUID
(Black cap)

AUTOMATIC
TRANSMISSION
FLUID DIPSTICK
(Yellow loop)

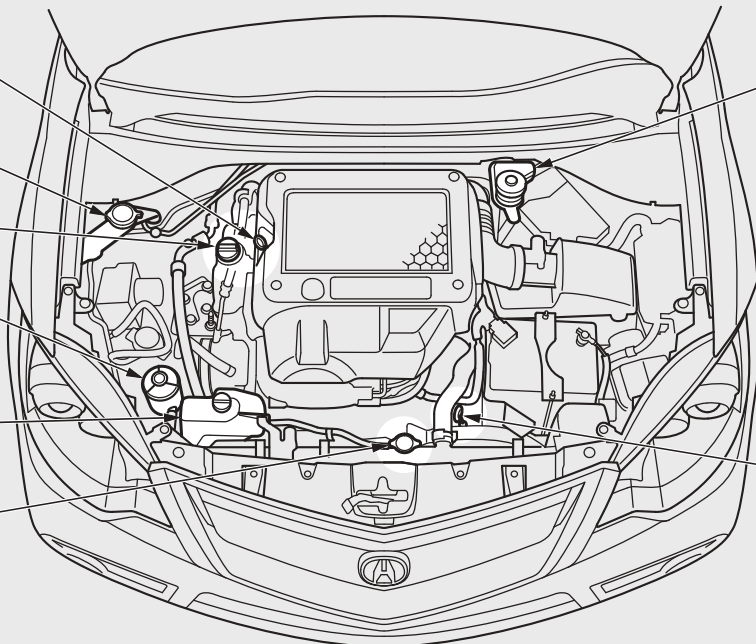

Adding Engine Oil

ENGINE OIL FILL CAP

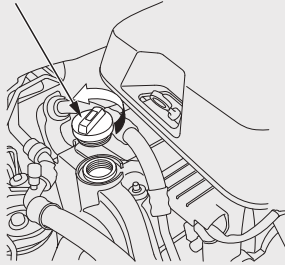

Unscrew and remove the engine oil fill cap on top of the valve cover. Pour in the oil slowly and carefully so you do not spill any. Clean up any spills immediately. Spilled oil could damage components in the engine compartment.

Reinstall the engine oil fill cap, and tighten it securely. Wait a few minutes, and recheck the oil level on the engine oil dipstick. Do not fill above the upper mark; you could damage the engine.

Required Engine Oil

Oil is a major contributor to your engine's performance and longevity. Your vehicle is equipped with a high-performance turbocharged engine that requires the use of synthetic motor oil. Always use Mobil 1[®] 5W-30 or an equivalent oil that meets the Acura HTO-06 standard. Not all synthetic oils will meet this standard. Only use oils that display the HTO-06 standard on the label.

Failure to use Mobil 1[®] or an equivalent oil that meets the HTO-06 standard can lead to a reduction in engine performance or durability, and can cause engine damage not covered by your warranty.

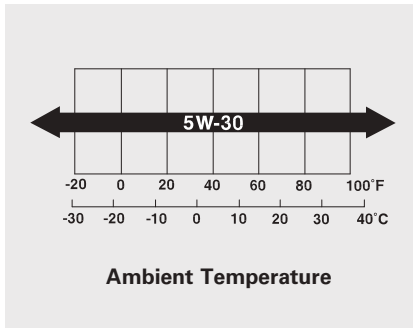

The oil viscosity or weight is provided on the container's label. 5W-30 oil is formulated for year-round protection of your vehicle to improve cold weather starting and fuel economy.

Engine Oil Additives

Your vehicle does not require any oil additives. Additives may adversely affect the engine or transmission performance and durability.

Changing the Engine Oil and Filter

Always change the oil and filter according to the maintenance messages shown on the multi-information display. The oil and filter collect contaminants that can damage your engine if they are not removed regularly.

Changing the oil and filter requires special tools and access from underneath the vehicle. The vehicle should be raised on a service station-type hydraulic lift for this service. Unless you have the knowledge and proper equipment, you should have this maintenance done by a skilled technician.

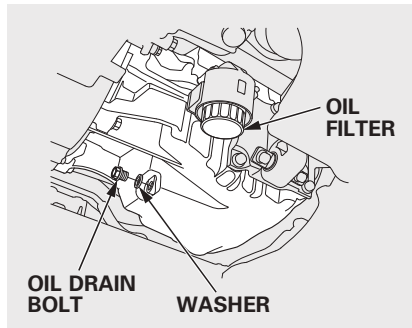

1. Run the engine until it reaches normal operating temperature, then shut it off.
2. Open the hood, and remove the engine oil fill cap. Remove the oil drain bolt and washer from the bottom of the engine. Drain the oil into an appropriate container.
3. Remove the oil filter, and let the remaining oil drain. A special wrench (available from your dealer) is required.
4. Check the oil filter to make sure its gasket did not stick to the filter base. A stuck gasket could cause an oil leak.
5. Install a new oil filter according to the instructions that come with it.

Changing the Engine Oil and Filter

6. Put a new washer on the drain bolt, then reinstall the drain bolt. Tighten the drain bolt to:
29 lbf·ft (40 N·m , 4.0 kgf·m)

7. Refill the engine with the recommended oil.

Engine oil change capacity
(including filter):
5.0 US qt (4.7 L)

8. Reinstall the engine oil fill cap. Start the engine. The oil pressure indicator should go out within 5 seconds. If it does not, turn off the engine, and check your work.

9. Let the engine run for several minutes, then check the drain bolt and oil filter for leaks.

10. Turn off the engine and let it sit for several minutes, then check the oil level on the dipstick. If necessary, add more oil.

NOTICE

Improper disposal of engine oil can be harmful to the environment. If you change your own oil, please dispose of the used oil properly. Put it in a sealed container and take it to a recycling center. Do not discard it in a trash bin or dump it on the ground.

Engine Coolant

Adding Engine Coolant

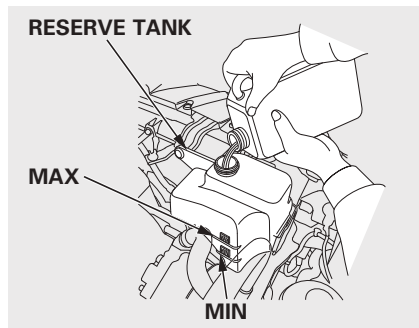

If the coolant level in the reserve tank is at or below the MIN line, add coolant to bring it up to the MAX line. Inspect the cooling system for leaks.

Always use Honda Long-life Antifreeze/Coolant Type 2. This coolant is pre-mixed with 50 percent antifreeze and 50 percent water. Never add straight antifreeze or plain water.

If Honda antifreeze/coolant is not available, you may use another major-brand non-silicate coolant as a temporary replacement. Make sure it is a high-quality coolant recommended for aluminum engines. Continued use of any non-Honda coolant can result in corrosion, causing the cooling system to malfunction or fail. Have the cooling system flushed and refilled with Honda antifreeze/coolant as soon as possible.

If the reserve tank is completely empty, you should also check the coolant level in the radiator.

⚠ WARNING

Removing the radiator cap while the engine is hot can cause the coolant to spray out, seriously scalding you.

Always let the engine and radiator cool down before removing the radiator cap.

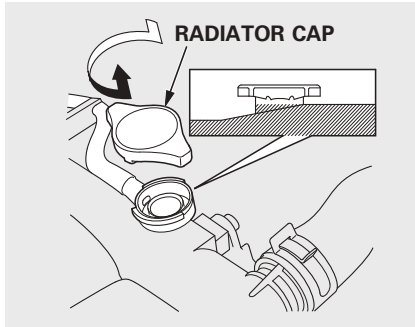

1. Make sure the engine and radiator are cool.
2. Relieve any pressure in the cooling system by turning the radiator cap counterclockwise, without pressing down.
3. Remove the radiator cap by pushing down and turning counterclockwise.

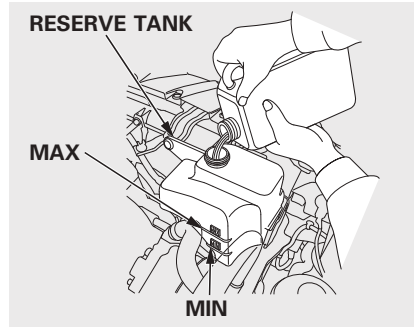

4. The coolant level should be up to the base of the filler neck. Add coolant if it is low.

Pour the coolant slowly and carefully so you do not spill any. Clean up any spills immediately; it could damage components in the engine compartment.

5. Put the radiator cap back on, and tighten it fully.
6. Pour coolant into the reserve tank. Fill it halfway between the MAX and MIN marks. Put the cap back on the reserve tank.

Do not add any rust inhibitors or other additives to your vehicle's cooling system. They may not be compatible with the coolant or engine components.

Windshield Washers

Check the fluid level in the windshield washer reservoir at least monthly during normal use.

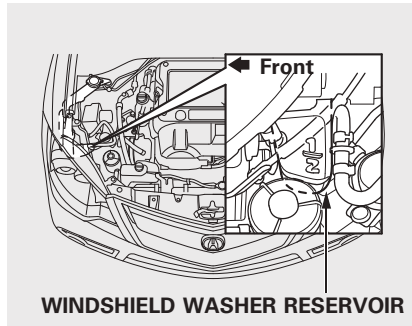

On U.S. models: To check the windshield washer fluid level, open the hood and look at the windshield washer reservoir located behind the left headlight. You will see a “1/2” mark on the reservoir.

On Canadian models
If the washer fluid is low, a “WASHER FLUID LOW” message appears on the multi-information display.

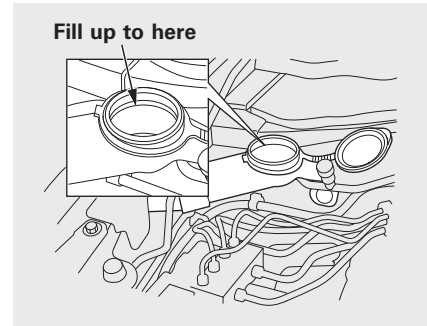

Fill the reservoir with a good-quality windshield washer fluid. This increases the cleaning capability and prevents freezing in cold weather.

When you refill the reservoir, clean the edges of the windshield wiper blades with windshield washer fluid on a clean cloth. This will help to condition the blade edges.

Windshield Washers, Automatic Transmission Fluid

NOTICE

Do not use engine antifreeze or a vinegar/water solution in the windshield washer reservoir. Antifreeze can damage your vehicle's paint, while a vinegar/water solution can damage the windshield washer pump. Use only commercially-available windshield washer fluid.

Automatic Transmission Fluid

The transmission should be drained and refilled with new fluid when this service is shown on a maintenance message on the multi-information display.

Check the fluid level with the engine at normal operating temperature.

1. Park the vehicle on level ground. Start the engine, let it run until the radiator fan comes on, then shut off the engine. For accurate results, wait about 60 seconds (but no longer than 90 seconds) before doing step 2.

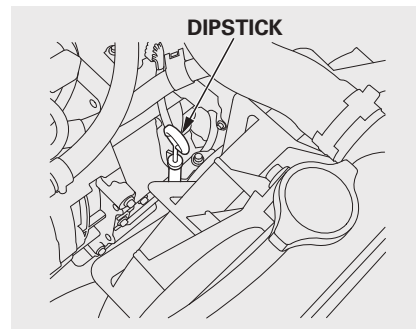

2. Remove the dipstick (yellow loop) from the transmission, and wipe it with a clean cloth.

CONTINUED

Automatic Transmission Fluid

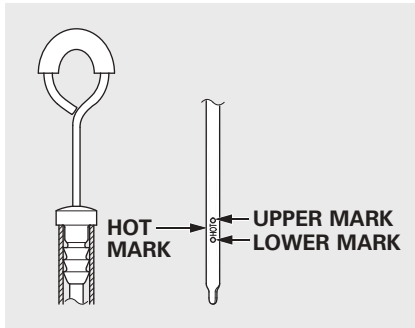

3. Insert the dipstick all the way into the transmission securely as shown in the illustration.
4. Remove the dipstick and check the fluid level. It should be between the upper and lower marks.

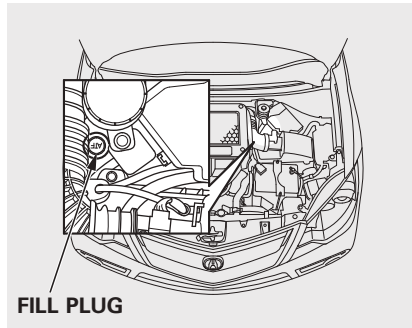

5. If the level is below the lower mark, remove the fill plug, then add the fluid into the fill hole to bring it to the level between the upper and lower marks on the dipstick.

Pour the fluid slowly and carefully so you do not spill any. Clean up any spills immediately; it could damage components in the engine compartment.

Always use Acura ATF-Z1 (automatic transmission fluid).

NOTICE

Use only Acura ATF-Z1 (automatic transmission fluid). Do not mix with other transmission fluids. Using transmission fluid other than Acura ATF-Z1 may cause deterioration in transmission operation and durability, and could result in damage to the transmission. Damage resulting from the use of transmission fluid other than Acura ATF-Z1 is not covered by the Acura new vehicle warranty.

6. Insert the dipstick all the way back into the transmission securely as shown in the illustration.

If you are not sure how to add fluid, contact your dealer.

Check the fluid level in the brake fluid reservoir monthly.

Replace the brake fluid every 3 years, independent of distance traveled.

Always use Honda Heavy Duty Brake Fluid DOT 3. If it is not available, you should use only DOT 3 or DOT 4 fluid, from a sealed container, as a temporary replacement.

Using any non-Honda brake fluid can cause corrosion and decrease the life of the system. Have the brake system flushed and refilled with Honda Heavy Duty Brake Fluid DOT 3 as soon as possible.

Brake fluid marked DOT 5 is not compatible with your vehicle's braking system and can cause extensive damage.

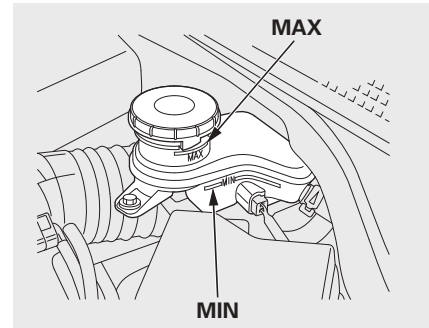

The fluid level should be between the MIN and MAX marks on the side of the reservoir. If the level is at or below the MIN mark, your brake system needs attention. Have the brake system inspected for leaks or worn brake pads.

Power Steering Fluid

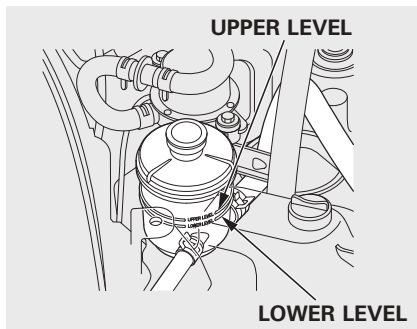

Check the level on the side of the reservoir when the engine is cold. The fluid should be between the UPPER LEVEL and LOWER LEVEL. If not, add power steering fluid to the UPPER LEVEL.

Pour the fluid slowly and carefully so you do not spill any. Clean up any spills immediately; it could damage components in the engine compartment.

Always use Acura Power Steering Fluid. You may use another power steering fluid as an emergency replacement, but have the power steering system flushed and refilled with Acura PSF as soon as possible.

A low power steering fluid level can indicate a leak in the system. Check the fluid level frequently, and have the system inspected as soon as possible.

If you are not sure how to add fluid, contact your dealer.

NOTICE

Turning the steering wheel to full left or right lock and holding it there can damage the power steering pump.

Headlight Aiming

The headlights were properly aimed when your vehicle was new. If you regularly carry heavy items in the cargo area or pull a trailer, readjustment may be required. Adjustments should be done by your dealer or another qualified technician.

Low Beam Headlight Bulb Replacement

The low beam headlight bulbs are high voltage discharge tube. High voltage can remain in the circuit even with the light switch off and the key removed. Because of this, you should not attempt to examine or change a low beam headlight bulb yourself. If a low beam headlight bulb fails, take the vehicle to your dealer to have it replaced.

Replacing a High Beam Headlight Bulb

Your vehicle has halogen headlight bulbs. When replacing a bulb, handle it by its base, and protect the glass from contact with your skin or hard objects. If you touch the glass, clean it with denatured alcohol and a clean cloth.

NOTICE

Halogen headlight bulbs get very hot when lit. Oil, perspiration, or a scratch on the glass can cause the bulb to overheat and shatter.

1. Open the hood.
Remove the electrical connector from the bulb by pushing on the tab and pulling the connector down.
2. Remove the bulb by turning it about one-quarter turn counterclockwise.

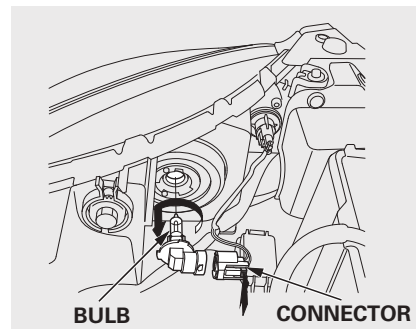

3. Insert the new bulb into the hole, and turn it one-quarter turn clockwise to lock it in place.
4. Push the electrical connector onto the new bulb.
5. Turn on the headlights to test the new bulb.

CONTINUED

Lights

Replacing a Front Turn Signal/ Parking Light Bulb

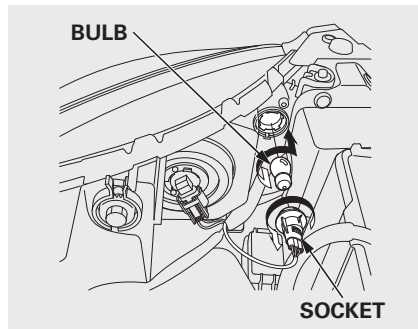

1. Open the hood. Remove the socket from the headlight assembly by turning it one-quarter turn counterclockwise.
2. Remove the bulb from the socket by pushing the bulb in and turning it counterclockwise until it unlocks.

3. Install the new bulb in the socket. Turn it clockwise to lock it in place.
4. Test the lights to make sure the new bulb is working.
5. Insert the socket back into the headlight assembly. Turn it clockwise to lock it in place.

Replacing a Front Side Marker Light Bulb

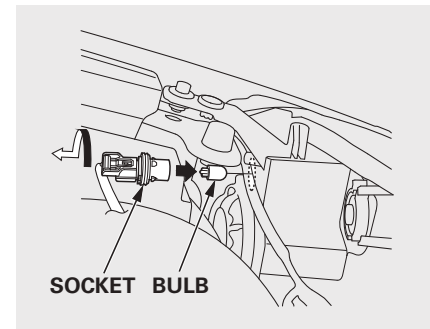

1. Open the hood. Remove the socket from the headlight assembly by turning it one-quarter turn counterclockwise.
2. Pull the bulb straight out of its socket. Push the new bulb straight into the socket until it bottoms.

3. Install the socket back into the headlight assembly. Turn it clockwise to lock it in place.
4. Turn on the lights to make sure the new bulb is working.

Replacing Rear Bulbs (in Tailgate)

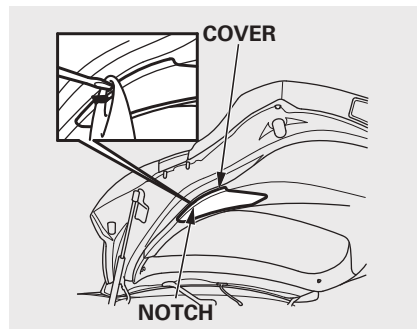

1. Open the tailgate. Place a cloth on the edge of the light assembly cover to prevent scratches. Remove the cover by carefully prying in the notch on its middle edge with a flat-tip screwdriver.
2. Determine which of the two bulbs is burned out: taillight or back-up light.

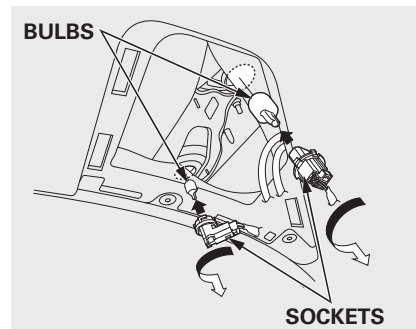

3. Remove the socket by turning it one-quarter turn counterclockwise.
4. Pull the bulb straight out of its socket. Push the new bulb straight into the socket until it bottoms.

CONTINUED

Lights

5. Turn on the lights to make sure the new bulb is working.
6. Reinstall the socket into the light assembly by turning it clockwise until it locks.
7. Reinstall the light assembly cover.

Replacing Rear Bulbs (in Rear Pillar)

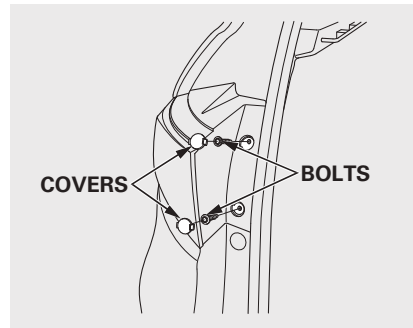

1. Open the tailgate.
2. Remove the two bolt covers on the rear pillar by prying on the bottom edge with a flat-tip screwdriver. Remove the bolts with a Phillips-head screwdriver, and remove the light assembly from the rear pillar.

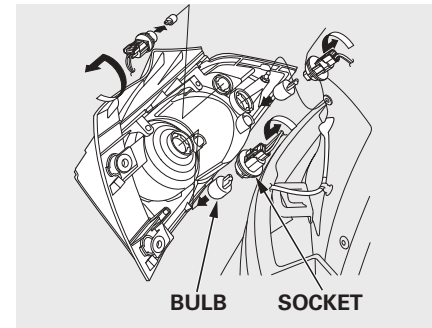

3. Determine which of the three bulbs is burned out: brake/taillight, turn signal or rear side marker.
4. Remove the socket by turning it one-quarter turn counterclockwise.
5. Pull the bulb straight out of its socket. Push the new bulb straight into the socket until it bottoms.

6. Turn on the lights to make sure the new bulb is working.
7. Put the socket back into the light assembly, and turn it clockwise to lock it in place.
8. Install the rear light assembly in the rear pillar. Tighten the two bolts. Snap the bolt covers into position.

Replacing a Front Fog Light Bulb

Your vehicle uses halogen light bulbs. When replacing a bulb, handle it by its plastic case, and protect the glass from contact with your skin or hard objects. If you touch the glass, clean it with denatured alcohol and a clean cloth.

NOTICE

Halogen bulbs get very hot when lit. Oil, perspiration, or a scratch on the glass can cause the bulb to overheat and shatter.

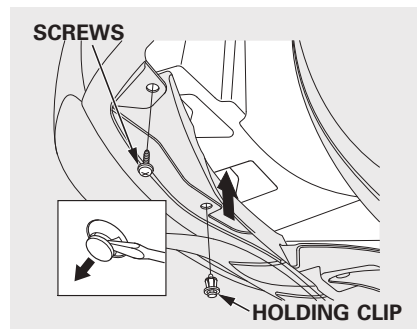

1. Use a Phillips-head screwdriver to remove the screw and use a flat-tip screwdriver to remove the holding clip located under the front bumper.
2. Push up the undercover.

CONTINUED

Lights

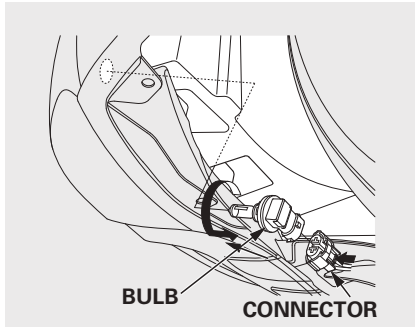

3. Remove the electrical connector from the bulb by pushing on the tab and pulling the connector down.
4. Remove the bulb from the fog light assembly by turning it one-quarter turn counterclockwise.

5. Install the new bulb into the hole and turn it one-quarter turn clockwise to lock it in place.
6. Push the electrical connector back onto the bulb. Make sure it is on all the way.
7. Turn on the fog lights to test the new bulb.
8. Put the undercover in place. Reinstall the clip, and tighten the screw securely.

Replacing a High-mount Brake Light Bulb

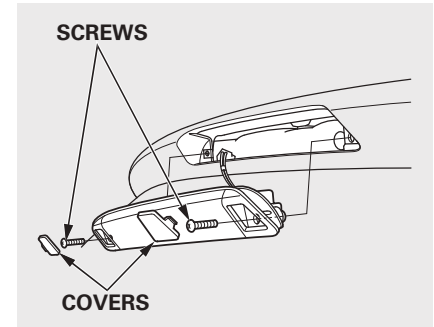

1. Remove the two screw covers on the light assembly by prying on the side edge with a flat-tip screwdriver.
2. Remove the screws with a Phillips-head screwdriver, then remove the light assembly from the tailgate.

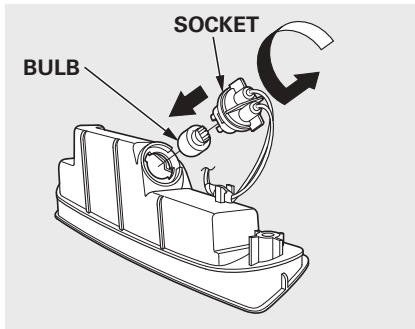

3. Remove the socket from the light assembly by turning it one-quarter turn counterclockwise.
4. Pull the bulb straight out of its socket. Push the new bulb straight into the socket until it bottoms.

5. Press the brake pedal to make sure the new bulb is working.
6. Put the socket back into the light assembly, and turn it clockwise to lock it in place.
7. Reinstall the high-mount brake light assembly into the tailgate. Tighten the two screws and reinstall the covers.

Side Turn Signal Lights

Each outside mirror has side turn signal lights. The lights should be replaced by your dealer.

Replacing a Rear License Plate Light Bulb

The license plate has two lights above it. The bulbs should be replaced by your dealer.

Cleaning the Seat Belts, Floor Mats

Cleaning the Seat Belts

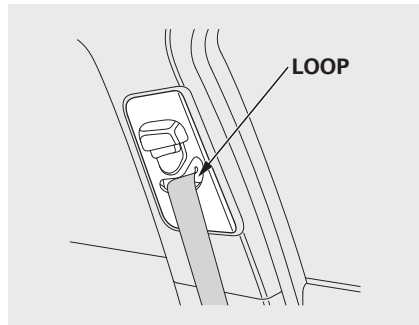

If your seat belts get dirty, use a soft brush with a mixture of mild soap and warm water to clean them. Do not use bleach, dye, or cleaning solvents. Let the belts air-dry before you use the vehicle.

Dirt build-up in the loops of the seat belt anchors can cause the belts to retract slowly. Wipe the insides of the loops with a clean cloth dampened in mild soap and warm water or isopropyl alcohol.

Floor Mats

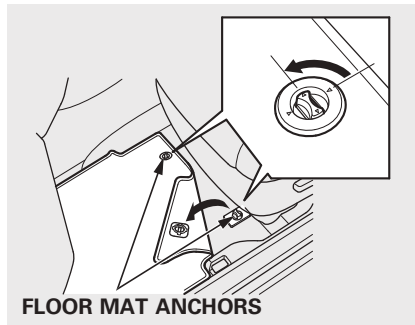

The driver's and front passenger's floor mats that came with your vehicle hook over the floor mat anchors. To lock each anchor, turn the knob clockwise. This keeps the floor mats from sliding forward (possibly interfering with the pedals), or backwards (making the front passenger's weight sensors ineffective). If you remove a floor mat, make sure to re-anchor it when you put it back in your vehicle.

If you use a non-Acura floor mat, make sure it fits properly and that it can be used with the floormat anchors. Do not put additional floor mats on top of the anchored mats.

Audio Antenna, Intercooler, Dust and Pollen Filter

Audio Antenna

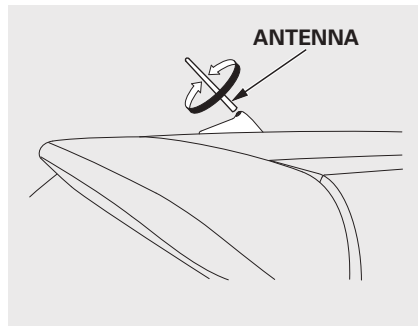

NOTICE

Your vehicle is equipped with an antenna at the rear of the roof. Before using a “drive-through” car wash, remove the antenna by unscrewing it by hand. This prevents the antenna from being damaged by the car wash brushes.

Intercooler

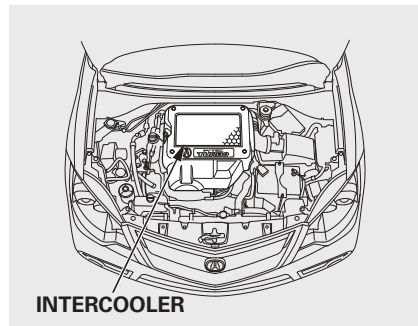

Your vehicle is equipped with a intercooler on the engine to cool the air flow from a turbo charger into the engine. The intercooler fins bend easily. Do not push them with your finger.

NOTICE

Do not spray water (from such sources as garden hoses, high pressure sprayers) into the engine compartment. It may cause serious damage to your vehicle, and could also damage the intercooler fins.

Dust and Pollen Filter

This filter removes the dust and pollen that is brought in from the outside through the climate control system.

Have your dealer replace the filter when this service is indicated by a maintenance message on the multi-information display. It should be replaced every 15,000 miles (24,000 km) if you drive primarily in urban areas that have high concentrations of soot in the air, or if the flow from the climate control system becomes less than usual.

Wiper Blades

Check the condition of the wiper blades at least every six months. Replace them if you find signs of cracking in the rubber, areas that are getting hard, or if they leave streaks and unwiped areas when used.

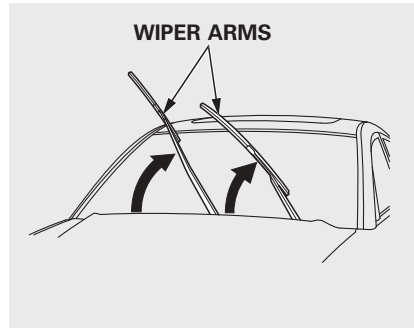

To replace a front wiper blade:

1. Raise each wiper arm off the windshield, lifting the driver's side first, then the passenger's side.

NOTICE

Do not open the hood when the wiper arms are raised, or you will damage the hood and the wiper arms.

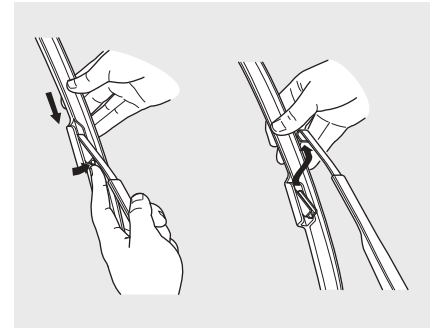

2. Disconnect the blade assembly from the wiper arm:
 - Press and hold the lock tab.
 - Slide the blade assembly toward the lock tab until it releases from the wiper arm.

When replacing a wiper blade, make sure not to drop the wiper blade or wiper arm down on the windshield.

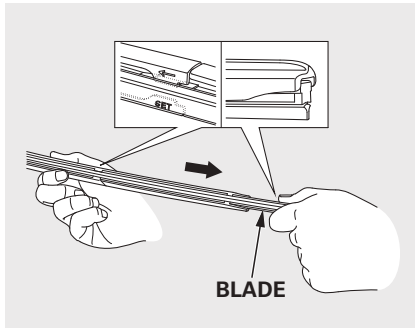

3. Remove the blade from the blade assembly:

- Find two tabs with a “SET” and “←” mark on the wiper blade assembly. The opposite side of the “←” mark is the direction you pull out the wiper blade.
- Pull out the blade by grabbing the end of it as shown in the above illustration.

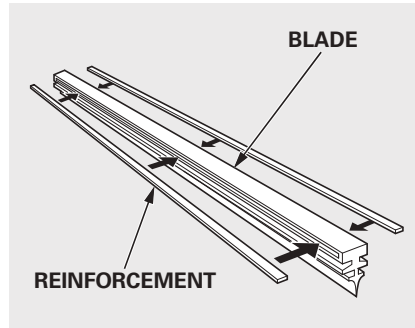

4. Examine the new wiper blades. If they have no plastic or metal reinforcement along the back edge, remove the metal reinforcement strips from the old wiper blade, and install them in the slots along the edge of the new blade.

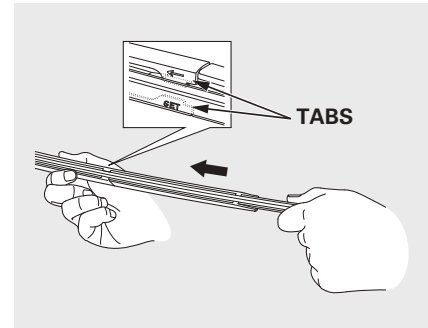

5. Install the new blade onto the blade assembly:

- Find two tabs with a “SET” and “←” mark on the wiper blade assembly. This is the direction you install.
- Slide the blade onto the assembly until it is locked by the tabs.

CONTINUED

Wiper Blades

- Slide the wiper blade assembly onto the wiper arm. Make sure it locks in place.
- Make sure the blade is completely installed and that its edge is not bunched up.
- Lower the wiper arm down against the windshield, the passenger's side first, then the driver's side.

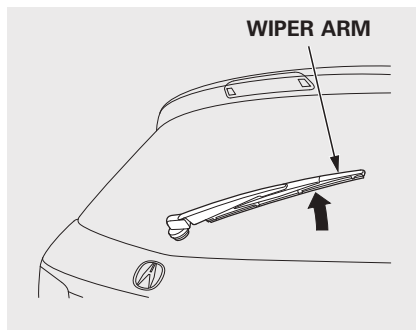

To replace the rear wiper blade:

1. Raise the wiper arm off the rear window.

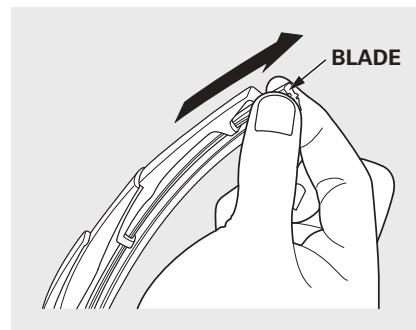

2. Slide the blade out of the wiper arm.

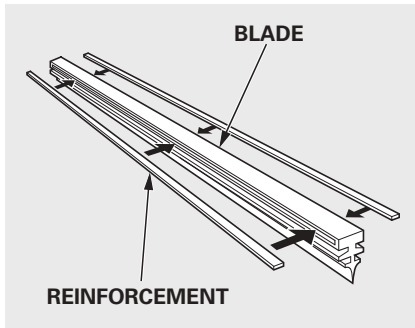

3. Examine the new wiper blades. If they have no plastic or metal reinforcement along the back edge, remove the metal reinforcement strips from the old wiper blade, and install them in the slots along the edge of the new blade.

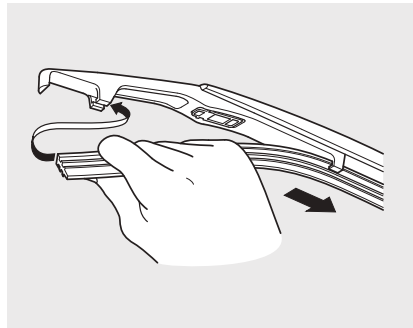

4. Slide the new blade into the wiper arm. Make sure it is engaged in the slot along its full length.
5. Lower the wiper arm.

Wheels

Clean the wheels as you would the rest of the exterior. Wash them with the same solution, and rinse them thoroughly.

Aluminum alloy wheels have a protective clear-coat that keeps the aluminum from corroding and tarnishing. Cleaning the wheels with harsh chemicals (including some commercial wheel cleaners) or a stiff brush can damage the clear-coat. To clean the wheels, use a mild detergent and a soft brush or sponge.

Tires

To safely operate your vehicle, your tires must be the proper type and size, in good condition with adequate tread, and correctly inflated.

The following pages give more detailed information on how to take care of your tires and what to do when they need to be replaced.

WARNING

Using tires that are excessively worn or improperly inflated can cause a crash in which you can be seriously hurt or killed.

Follow all instructions in this owner's manual regarding tire inflation and maintenance.

Inflation Guidelines

Keeping the tires properly inflated provides the best combination of handling, tread life, and riding comfort.

- Underinflated tires wear unevenly, adversely affect handling and fuel economy, and are more likely to fail from being overheated.
- Overinflated tires can make your vehicle ride more harshly, are more prone to damage from road hazards, and wear unevenly.

The tire pressure monitoring system (TPMS) will warn you when a tire pressure is low. See page [390](#) for information on the TPMS.

Even though your vehicle is equipped with TPMS, we recommend that you visually check your tires every day. If you think a tire might be low, check it immediately with a tire gauge.

Use a gauge to measure the air pressure in each tire at least once a month. Even tires that are in good condition may lose 1 to 2 psi (10 to 20 kPa, 0.1 to 0.2 kgf/cm²) per month. Remember to check the spare tire at the same time.

Check the air pressures when the tires are cold. This means the vehicle has been parked for at least 3 hours, or driven less than 1 mile (1.6 km). Add or release air, if needed, to match the recommended cold tire pressures.

If you check air pressures when the tires are hot (driven for several miles/kilometers), you will see readings 4 to 6 psi (30 to 40 kPa, 0.3 to 0.4 kgf/cm²) higher than the cold readings. This is normal. Do not let air out to match the recommended cold air pressure. The tire will be underinflated.

You should get your own tire pressure gauge and use it whenever you check your tire pressures. This will make it easier for you to tell if a pressure loss is due to a tire problem and not due to a variation between gauges.

While tubeless tires have some ability to self-seal if they are punctured, you should look closely for punctures if a tire starts losing pressure.

Recommended Tire Pressures

The following charts show the recommended cold tire pressures for most normal driving conditions.

| Tire Size | Cold Tire Pressure for Normal Driving |
|----------------|---|
| P235/55R18 99V | Front/Rear: 32 psi (220 kPa , 2.2 kgf/cm ²) |

The compact spare tire pressure is: 60 psi (420 kPa , 4.2 kgf/cm²)

For convenience, the recommended tire sizes and cold tire pressures are on a label on the driver's doorjamb.

For additional information about your tires, see page [484](#).

Tire Inspection

Every time you check inflation, you should also examine the tires for damage, foreign objects, and wear.

You should look for:

- Bumps or bulges in the tread or side of the tire. Replace the tire if you find either of these conditions.
- Cuts, splits, or cracks in the side of the tire. Replace the tire if you can see fabric or cord.
- Excessive tread wear.

CONTINUED

Tires

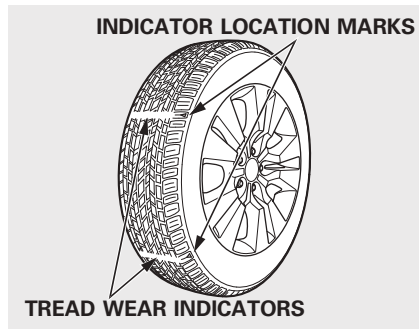

Your tires have wear indicators molded into the tread. When the tread wears down, you will see a 1/2 inch (12.7 mm) wide band across the tread. This shows there is less than 1/16 inch (1.6 mm) of tread left on the tire.

A tire this worn gives very little traction on wet roads. You should replace the tire if you can see three or more tread wear indicators.

Tire Service Life

The service life of your tires is dependent on many factors, including, but not limited to, driving habits, road conditions, vehicle loading, inflation pressure, maintenance history, speed, and environmental conditions (even when the tires are not in use).

In addition to your regular inspections and inflation pressure maintenance, it is recommended that you have annual inspections performed once the tires reach five years old. It is also recommended that all tires, including the spare, be removed from service after 10 years from the date of manufacture, regardless of their condition or state of wear.

The last four digits of the TIN (tire identification number) are found on the sidewall of the tire and indicate the date of manufacture (See **Tire Labeling** on page 484).

Tire Maintenance

In addition to proper inflation, correct wheel alignment helps to decrease tire wear. If you find a tire is worn unevenly, have your dealer check the wheel alignment.

Have your dealer check the tires if you feel a consistent vibration while driving. A tire should always be rebalanced if it is removed from the wheel. When you have new tires installed, make sure they are balanced. This increases riding comfort and tire life. For best results, have the installer perform a dynamic balance.

NOTICE

Improper wheel weights can damage your vehicle's aluminum wheels. Use only Acura wheel weights for balancing.

Tire Rotation

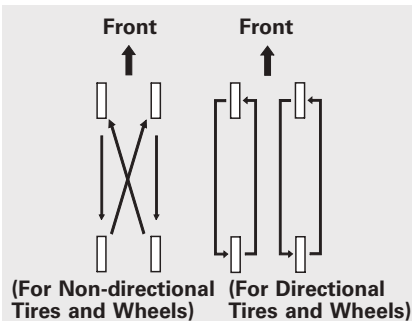

To help increase tire life and distribute wear more evenly, rotate the tires according to the maintenance messages displayed on the multi-information display. Move the tires to the positions shown in the illustration each time they are rotated. If you purchase directional tires, rotate only front-to-back.

Replacing Tires and Wheels

Replace your tires with radial tires of the same size, load range, speed rating, and maximum cold tire pressure rating (as shown on the tire's sidewall).

Mixing radial and bias-ply tires on your vehicle can reduce braking ability, traction, and steering accuracy. Using tires of a different size or construction can cause the ABS and vehicle stability assist system (VSA) to work inconsistently.

The ABS and VSA system work by comparing the speed of the wheels. When replacing tires, use the same size originally supplied with the vehicle. Tire size and construction can affect wheel speed and may cause the ABS or VSA system to activate.

It is best to replace all four tires at the same time. If that is not possible or necessary, replace the two front tires or two rear tires as a pair. Replacing just one tire can seriously affect your vehicle's handling.

If you ever replace a wheel, make sure that the wheel's specifications match those of the original wheels.

Also be sure you use only TPMS specific wheels. If you do not, the tire pressure monitoring system will not work.

Replacement wheels are available at your dealer.

CONTINUED

Tires

⚠ WARNING

Installing improper tires on your vehicle can affect handling and stability. This can cause a crash in which you can be seriously hurt or killed.

Always use the size and type of tires recommended in this owner's manual.

Wheel and Tire Specifications

Wheels:

18 x 7 1/2J (TPMS)

Tires:

P235/55R18 99V

See page [482](#) for information about DOT Tire Quality Grading, and page [484](#) for tire size and labeling information.

Winter Driving

Tires marked “M + S” or “All Season” on the sidewall have an all-weather tread design suitable for most winter driving conditions.

For the best performance in snowy or icy conditions, you should install snow tires or tire chains. They may be required by local laws under certain conditions.

Snow Tires

If you mount snow tires on your vehicle, make sure they are radial tires of the same size and load range as the original tires. Mount snow tires on all four wheels. The traction provided by snow tires on dry roads may be lower than your original tires. Check with the tire dealer for maximum speed recommendations.

Tire Chains

Mount tire chains on your tires when required by driving conditions or local laws. Install them only on the front tires.

Because your vehicle has limited tire clearance, Acura strongly recommends using the chains listed below, made by Security Chain Company (SCC).

Cable type: Shur Grip Z
SZ343

When installing cables, follow the manufacturer's instructions, and mount them as tight as you can. Make sure they are not contacting the brake lines or suspension. Drive slowly with them installed. If you hear them coming into contact with the body or chassis, stop and investigate. Remove them as soon as you begin driving on cleared roads.

NOTICE

Traction devices that are the wrong size or improperly installed can damage your vehicle's brake lines, suspension, body, and wheels. Stop driving if they are hitting any part of the vehicle.

WARNING

Using the wrong chains, or not properly installing chains, can damage the brake lines and cause a crash in which you can be seriously injured or killed.

Follow all instructions in this owner's manual regarding the selection and use of tire chains.

Checking the Battery

TEST INDICATOR WINDOW

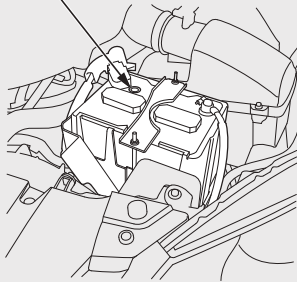

Check the condition of the battery monthly by looking at the test indicator window. The label on the battery explains the test indicator's colors.

Check the terminals for corrosion (a white or yellowish powder). To remove it, cover the terminals with a solution of baking soda and water. It will bubble up and turn brown. When this stops, wash it off with plain water. Dry off the battery with a cloth or paper towel. Coat the terminals with grease to help prevent future corrosion.

If additional battery maintenance is needed, see your dealer or a qualified technician.

WARNING: Battery posts, terminals, and related accessories contain lead and lead compounds. **Wash your hands after handling.**

If you need to connect the battery to a charger, disconnect both cables to prevent damaging your vehicle's electrical system. Always disconnect the negative (-) cable first, and reconnect it last.

⚠ WARNING

The battery gives off explosive hydrogen gas during normal operation.

A spark or flame can cause the battery to explode with enough force to kill or seriously hurt you.

Wear protective clothing and a face shield, or have a skilled technician do the battery maintenance.

On models without navigation system
If your vehicle's battery is disconnected, or goes dead, the time setting will be reset to 1:00. To set the time again, follow the setting procedure (see page [293](#)).

If your vehicle's battery is disconnected or goes dead, the audio system will disable itself. The next time you turn on the radio you will see "ENTER CODE" in the frequency display. Use the preset bars or preset buttons (depending on models) to enter the five-digit code (see page [292](#)).

On models with navigation system
The navigation system will also disable itself. The next time you turn on the ignition switch, the system will require you to enter a PIN before it can be used. Refer to the navigation system manual.

Vehicle Storage

If you need to park your vehicle for an extended period (more than 1 month), there are several things you should do to prepare it for storage. Proper preparation helps prevent deterioration and makes it easier to get your vehicle back on the road. If possible, store your vehicle indoors.

- Fill the fuel tank.
- Wash and dry the exterior completely.
- Clean the interior. Make sure the carpeting, floor mats, etc., are completely dry.
- Leave the parking brake off. Put the transmission in Park.

- Block the rear wheels.
- If the vehicle is to be stored for a longer period, it should be supported on jackstands so the tires are off the ground.
- Leave one window open slightly (if the vehicle is being stored indoors).
- Disconnect the battery.
- Support the front and rear wiper blade arms with a folded towel or rag so they do not touch the windshield.
- To minimize sticking, apply a silicone spray lubricant to all door and tailgate seals. Also, apply a vehicle body wax to the painted surfaces that mate with the door and tailgate seals.
- Cover the vehicle with a “breathable” cover, one made from a porous material such as cotton. Non-porous materials, such as plastic sheeting, trap moisture, which can damage the paint.
- If possible, periodically run the engine until it reaches full operating temperature (the cooling fans cycle on and off twice). Preferably, do this once a month.

This section covers the more common problems that motorists experience with their vehicles. It gives you information about how to safely evaluate the problem and what to do to correct it. If the problem has stranded you on the side of the road, you may be able to get going again. If not, you will also find instructions on getting your vehicle towed.

| | |
|----------------------------------|-----|
| Compact Spare Tire | 454 |
| Changing a Flat Tire | 455 |
| If the Engine Won't Start..... | 459 |
| Jump Starting | 461 |
| If the Engine Overheats | 463 |
| Low Oil Pressure Indicator | 465 |
| Charging System Indicator | 465 |
| Malfunction Indicator Lamp | 466 |
| Brake System Indicator..... | 467 |
| Fuses | 469 |
| Fuse Locations..... | 473 |
| Emergency Towing..... | 475 |

Compact Spare Tire

Use the compact spare tire as a temporary replacement only. Get your regular tire repaired or replaced, and put it back on your vehicle as soon as you can.

Check the inflation pressure of the compact spare tire every time you check the other tires. It should be inflated to:

60 psi (420 kPa , 4.2 kgf/cm²)

Follow these precautions:

- Never exceed 50 mph (80 km/h).
- This tire gives a harsher ride and less traction on some road surfaces. Use greater caution while driving.
- Do not mount snow chains on the compact spare tire.
- Do not use your compact spare tire on another vehicle unless it is the same make and model.
- After the flat tire is replaced with the spare tire, the low tire pressure/TPMS indicator stays on. After several miles (kilometers) driving with the spare, this indicator begins to flash, then stays on again. You will also see a “CHECK TPMS SYSTEM” message on the multi-information display (see page [393](#)).

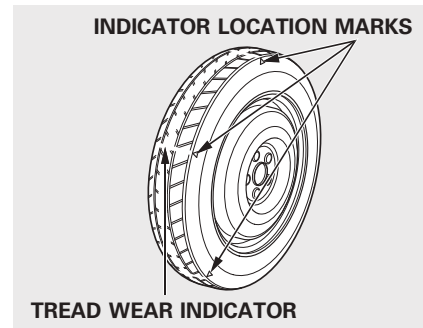

Replace the tire when you can see the tread wear indicator bars. The replacement should be the same size and design tire, mounted on the same wheel. The spare tire is not designed to be mounted on a regular wheel, and the spare wheel is not designed for mounting a regular tire.

Changing a Flat Tire

If you have a flat tire while driving, stop in a safe place to change it. Drive slowly along the shoulder until you get to an exit or an area that is far away from the traffic lanes.

⚠ WARNING

The vehicle can easily roll off the jack, seriously injuring anyone underneath.

Follow the directions for changing a tire exactly, and never get under the vehicle when it is supported only by the jack.

1. Park the vehicle on firm, level, and non-slippery ground. Put the transmission in Park. Apply the parking brake. If you are towing a trailer, unhitch it.
2. Turn on the hazard warning lights, and turn the ignition switch to the LOCK (0) position. Have all passengers get out of the vehicle while you change the tire.

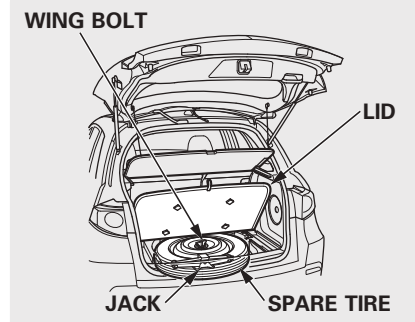

3. Open the tailgate. Raise the cargo area floor lid by lifting it up with the strap, then remove the lid. The spare tire, jack, and tools are under the cargo area floor.
4. Unscrew the wing bolt. Use the hooked end of the wheel nut wrench extension as a wrench if the wing bolt is hard to loosen. Then take the spare tire out of the cargo area.

CONTINUED

Changing a Flat Tire

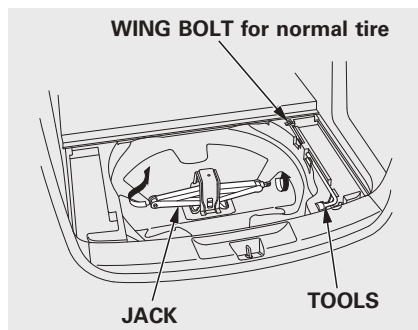

5. Remove the tools, wing bolt and the jack. To remove the jack, turn the jack's end bracket counterclockwise to loosen it.

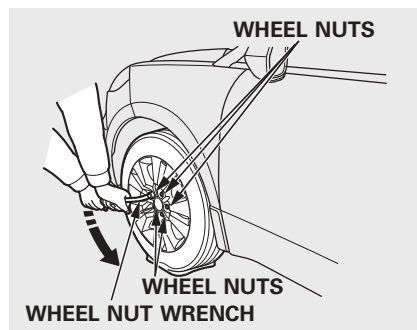

6. Loosen the five wheel nuts 1/2 turn with the wheel nut wrench.

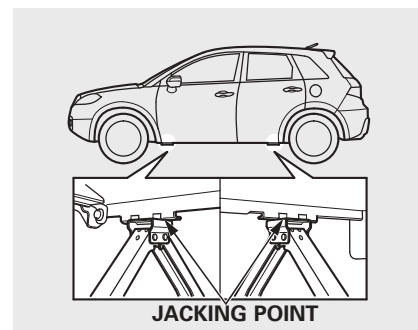

7. Place the jack under the jacking point nearest the tire you need to change. Turn the end bracket clockwise until the top of the jack contacts the jacking point. Make sure the jacking point tab is resting in the jack notch.

Changing a Flat Tire

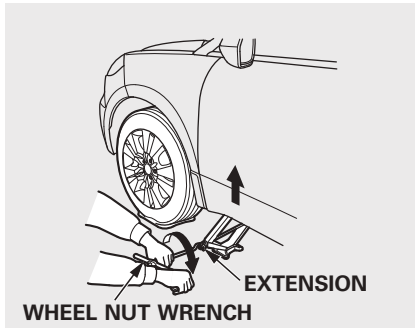

8. Use the extension and the wheel nut wrench as shown to raise the vehicle until the flat tire is off the ground.
9. Remove the wheel nuts, then remove the flat tire. Handle the wheel nuts carefully; they may be hot from driving. Place the flat tire on the ground with the outside surface facing up.

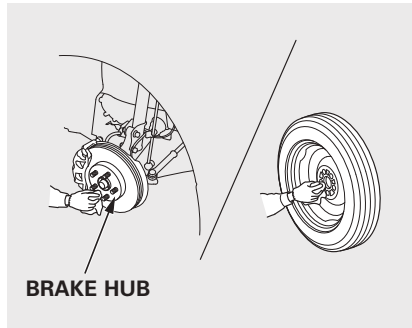

10. Before mounting the spare tire, wipe any dirt off the mounting surface of the wheel and hub with a clean cloth. Wipe the hub carefully; it may be hot from driving.

11. Put on the spare tire. Put the wheel nuts back on finger-tight, then tighten them in a crisscross pattern with the wheel nut wrench until the wheel is firmly against the hub. Do not try to tighten the wheel nuts fully.
12. Lower the vehicle to the ground, and remove the jack.

CONTINUED

Changing a Flat Tire

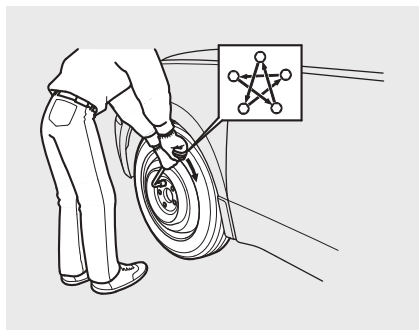

13. Tighten the wheel nuts securely in the same crisscross pattern. Have the wheel nut torque checked at the nearest automotive service facility.
Tighten the wheel nuts to:
80 lbf-ft (108 N·m, 11 kgf·m)
14. Store the jack in its holder. Turn the jack's end bracket to lock it in place. Store the tools.

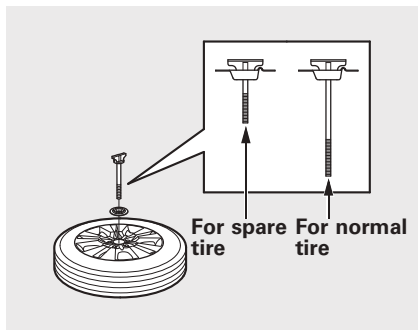

15. Remove the center cap from the flat tire, and store it in the cargo area.
16. Place the flat tire face up in the cargo area.
17. Secure the flat tire by screwing the wing bolt back into its hole.

⚠ WARNING

Loose items can fly around the interior in a crash and could seriously injure the occupants.

Store the wheel, jack, and tools securely before driving.

18. Reinstall the cargo area floor, and close the tailgate.
19. Your vehicle's original tire has a tire pressure monitoring system sensor. To replace a tire, refer to **Changing a Tire with TPMS** (see page 394).

Diagnosing why the engine won't start falls into two areas, depending on what you hear when you turn the ignition switch to the START (III) position:

- You hear nothing, or almost nothing. The engine's starter motor does not operate at all, or operates very slowly.
- You can hear the starter motor operating normally, or the starter motor sounds like it is spinning faster than normal, but the engine does not start up and run.

Nothing Happens or the Starter Motor Operates Very Slowly

When you turn the ignition switch to the START (III) position, you do not hear the normal noise of the engine trying to start. You may hear a clicking sound, a series of clicks, or nothing at all.

Check these things:

- Check the transmission interlock. The transmission must be in Park or neutral or the starter will not operate.
- Turn the ignition switch to the ON (II) position. Turn on the headlights, and check their brightness. If the headlights are very dim or do not come on at all, the battery is discharged. See **Jump Starting** on page 461.

- Turn the ignition switch to the START (III) position. If the headlights do not dim, check the condition of the fuses. If the fuses are OK, there is probably something wrong with the electrical circuit for the ignition switch or starter motor. You will need a qualified mechanic to determine the problem (see **Emergency Towing** on page 475).

If the headlights dim noticeably or go out when you try to start the engine, either the battery is discharged or the connections are corroded. Check the condition of the battery and terminal connections (see page 450). You can then try jump starting the vehicle from a booster battery (see page 461).

CONTINUED

If the Engine Won't Start

The Starter Operates Normally

In this case, the starter motor's speed sounds normal, or even faster than normal, when you turn the ignition switch to the START (III) position, but the engine does not run.

- Are you using a properly coded key? An improperly coded key will cause the immobilizer system indicator in the instrument panel to blink rapidly (see page [124](#)).
- Are you using the proper starting procedure? Refer to **Starting the Engine** on page [374](#).

- Do you have fuel? Check the fuel gauge; the low fuel indicator may not be working.
- There may be an electrical problem, such as no power to the fuel pump. Check all the fuses (see page [470](#)).

If you find nothing wrong, you will need a qualified technician to find the problem. See **Emergency Towing** on page [475](#).

Although this seems like a simple procedure, you should take several precautions.

⚠ WARNING

A battery can explode if you do not follow the correct procedure, seriously injuring anyone nearby.

Keep all sparks, open flames, and smoking materials away from the battery.

You cannot start your vehicle by pushing or pulling it.

To Jump Start Your Vehicle:

1. Open the hood, and check the physical condition of the battery. In very cold weather, check the condition of the electrolyte. If it seems slushy or frozen, do not try jump starting until it thaws.

NOTICE

If a battery sits in extreme cold, the electrolyte inside can freeze. Attempting to jump start with a frozen battery can cause it to rupture.

2. Turn off all electrical accessories: heater, A/C, climate control, audio system, lights, etc. Put the transmission in Park, and set the parking brake.

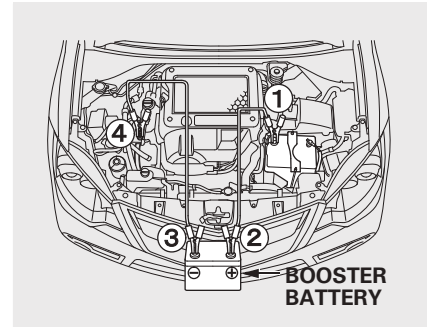

The numbers in the illustration show you the order to connect the jumper cables.

CONTINUED

Jump Starting

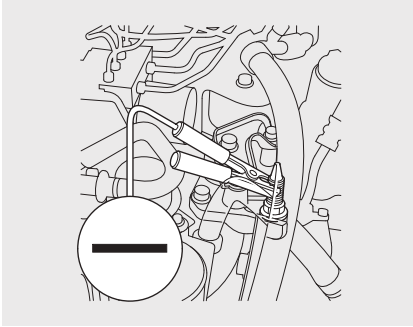

3. Connect one jumper cable to the positive (+) terminal on your battery. Connect the other end to the positive (+) terminal on the booster battery.
4. Connect the second jumper cable to the negative (-) terminal on the booster battery. Connect the other end to the grounding point as shown. Do not connect this jumper cable to any other part of the engine.
5. If the booster battery is in another vehicle, have an assistant start that vehicle and run it at a fast idle.
6. Start your vehicle. If the starter motor still operates slowly, check that the jumper cables have good metal-to-metal contact.
7. Once your vehicle is running, disconnect the negative cable from your vehicle, then from the booster battery. Disconnect the positive cable from your vehicle, then from the booster battery.

Keep the ends of the jumper cables away from each other and any metal on the vehicle until everything is disconnected. Otherwise, you may cause an electrical short.

If the Engine Overheats

The reading of the vehicle's temperature gauge on the multi-information display should stay in the midrange. If it climbs to the H (Hot) mark, you should determine the reason (hot day, driving up a steep hill, etc.).

If the coolant temperature rises to 224°F (118°C) or more, the temperature gauge will appear on the display and blink for several times. At the same time, the beeper will sound once.

If your vehicle overheats, you should take immediate action. The only indication may be the temperature gauge climbing to the H (Hot) mark. Or you may see steam or spray coming from under the hood.

NOTICE

Driving with the temperature gauge reading at the H (Hot) mark can cause serious damage to the engine.

⚠ WARNING

Steam and spray from an overheated engine can seriously scald you.

Do not open the hood if steam is coming out.

1. Safely pull to the side of the road. Put the transmission in Park, and set the parking brake. Turn off all accessories, and turn on the hazard warning lights.

2. If you see steam and/or spray coming from under the hood, turn off the engine. Wait until you see no more signs of steam or spray, then open the hood.
3. If you do not see steam or spray, leave the engine running and watch the temperature gauge. If the high heat is due to overloading, the engine should start to cool down almost immediately. If it does, wait until the temperature gauge comes down to the midpoint, then continue driving.
4. If the temperature gauge reading stays at the H (Hot) mark, turn off the engine.

CONTINUED

If the Engine Overheats

5. Look for any obvious coolant leaks, such as a split radiator hose. Everything is still extremely hot, so use caution. If you find a leak, it must be repaired before you continue driving (see **Emergency Towing** on page 475).
6. If you do not find an obvious leak, check the coolant level in the radiator reserve tank. Add coolant if the level is below the MIN mark.
7. If there was no coolant in the reserve tank, you may need to add coolant to the radiator. Let the engine cool down until the reading reaches the middle of the temperature gauge or lower before checking the radiator.

⚠ WARNING

Removing the radiator cap while the engine is hot can cause the coolant to spray out, seriously scalding you.

Always let the engine and radiator cool down before removing the radiator cap.

8. Using gloves or a large heavy cloth, turn the radiator cap counterclockwise, without pushing down, to the first stop. After the pressure releases, push down on the cap, and turn it until it comes off.
9. Start the engine, and set the temperature to maximum heat (climate control to AUTO at “H”). Add coolant to the radiator up to the base of the filler neck. If you do not have the proper coolant mixture available, you can add plain water. Remember to have the cooling system drained and refilled with the proper mixture as soon as you can.
10. Put the radiator cap back on tightly. Run the engine, and watch the temperature gauge. If it goes back to the H mark, the engine needs repair (see **Emergency Towing** on page 475).
11. If the temperature stays normal, check the coolant level in the radiator reserve tank. If it has gone down, add coolant to the MAX mark. Put the cap back on tightly.

Low Oil Pressure Indicator, Charging System Indicator

Low Oil Pressure Indicator



This indicator should never come on when the engine is running. If it starts flashing or stays on, the oil pressure has dropped very low or lost pressure. Serious engine damage is possible, and you should take immediate action.

You will also see an “OIL PRESSURE LOW” message on the multi-information display (see page 79).

NOTICE

Running the engine with low oil pressure can cause serious mechanical damage almost immediately. Turn off the engine as soon as you can safely get the vehicle stopped.

1. Safely pull off the road, and shut off the engine. Turn on the hazard warning lights.
2. Let the vehicle sit for a minute. Open the hood, and check the oil level (see page 356). An engine very low on oil can lose pressure during cornering and other driving maneuvers.
3. If necessary, add oil to bring the level back to the full mark on the dipstick (see page 420).
4. Start the engine, and watch the oil pressure indicator. If it does not go out within 10 seconds, turn off the engine. There is a mechanical problem that needs to be repaired before you can continue driving (see **Emergency Towing** on page 475).

Charging System Indicator



If the charging system indicator comes on brightly when the engine is running, the battery is not being charged.

You will also see a “CHECK CHARGING SYSTEM” message on the multi-information display (see page 79).

Immediately turn off all electrical accessories. Try not to use other electrically operated controls such as the power windows. Keep the engine running; starting the engine will discharge the battery rapidly.

Go to a service station or garage where you can get technical assistance.

Malfunction Indicator Lamp



If the indicator comes on while driving, it means one of the engine's emissions control systems may have a problem. Even though you may feel no difference in your vehicle's performance, it can reduce your fuel economy and cause increased emissions. Continued operation may cause serious damage.

If you have recently refueled your vehicle, the indicator coming on could be due to a loose or missing fuel fill cap. You will also see a "TIGHTEN FUEL CAP" message on the multi-information display. Tighten the cap until it clicks at least once. Tightening the cap will not turn the indicator off immediately; it can take several days of normal driving.

If the indicator comes on repeatedly, even though it may turn off as you continue driving, have your vehicle checked by your dealer as soon as possible.

NOTICE

If you keep driving with the malfunction indicator lamp on, you can damage your vehicle's emissions controls and engine. Those repairs may not be covered by your vehicle's warranties.

The indicator may also come on with the "D" indicator.

You will also see a "CHECK EMISSION SYSTEM" message on the multi-information display (see page 79).

Readiness Codes

Your vehicle has certain "readiness codes" that are part of the on-board diagnostics for the emissions systems. In some states, part of the emissions testing is to make sure these codes are set. If they are not set, the test cannot be completed.

If the battery in your vehicle has been disconnected or gone dead, these codes may be erased. It can take several days of driving under various conditions to set the codes again.

To check if they are set, turn the ignition switch to the ON (II) position, without starting the engine. The malfunction indicator lamp will come on for 20 seconds. If it then goes off, the readiness codes are set. If it blinks five times, the readiness codes are not set. If possible, do not take your vehicle for an emissions test until the readiness codes are set. Refer to **Emissions Testing** for more information (see page 490).

Brake System Indicator (Red)

U.S.

Canada

BRAKE



The brake system indicator (red) normally comes on when you turn the ignition switch to the ON (II) position, and as a reminder to check the parking brake. It will stay on if you do not fully release the parking brake.

If the brake system indicator (red) comes on while driving, the brake fluid level is probably low. Press lightly on the brake pedal to see if it feels normal. If it does, check the brake fluid level the next time you stop at a service station (see page [429](#)).

You will also see a “BRAKE FLUID LOW” message on the multi-information display (see page [79](#)).

If the fluid level is low, take your vehicle to a dealer, and have the brake system inspected for leaks or worn brake pads.

However, if the brake pedal does not feel normal, you should take immediate action. A problem in one part of the system's dual circuit design will still give you braking at two wheels. You will feel the brake pedal go down much farther before the vehicle begins to slow down, and you will have to press harder on the pedal.

You will also see a “CHECK BRAKE SYSTEM” message on the multi-information display (see page [79](#)).

Slow down by shifting to a lower gear, and pull to the side of the road when it is safe. Because of the long distance needed to stop, it is hazardous to drive the vehicle. You should have it towed, and repaired as soon as possible (see **Emergency Towing** on page [475](#)).

If you must drive the vehicle a short distance in this condition, drive slowly and carefully.

If the ABS indicator and the VSA system indicator come on with the brake system indicator, have your vehicle inspected by your dealer immediately.

Brake System Indicator

Brake System Indicator (Amber)

U.S.

Canada



Your vehicle has an electric vacuum pump located in the engine compartment. It enhances the effectiveness of your vehicle's brake system more frequently when you drive in cold weather or thinner air at high altitude after the engine is started.

When the electric vacuum pump is in operation, it makes some mechanical noises come from the engine compartment. This is normal.

The brake system indicator (amber) on the instrument panel normally comes on when you turn the ignition switch to the ON (II) position and goes off after the engine starts. If it comes on at any other time, press on the brake pedal with your foot several times until the indicator turns off. If the indicator is still on or comes on again after this procedure, there is a problem in the brake system including the electric vacuum pump. If this happens, the brake pedal might feel heavy when you press it. Have your vehicle checked by your dealer.

You will also see a “CHECK BRAKE SYSTEM” message on the multi-information display (see page 79).

INTERIOR

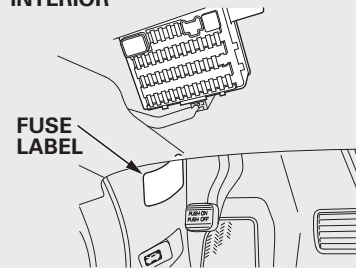

The vehicle's fuses are contained in three fuse boxes.

The interior fuse box is on the driver's lower left side.

UNDER-HOOD (PRIMARY)

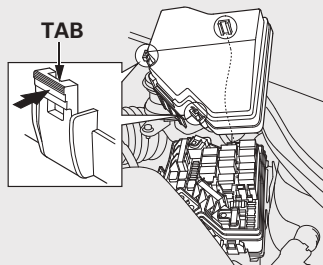

The primary under-hood fuse box is in the engine compartment on the driver's side. To open it, push the tabs as shown.

UNDER-HOOD (SECONDARY)

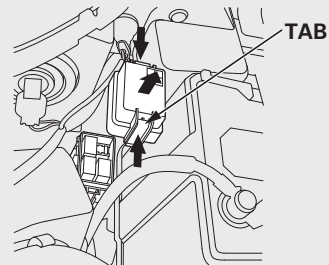

The secondary under-hood fuse box is next to the battery. To open it, push the tabs as shown.

CONTINUED

Fuses

Checking and Replacing Fuses

If something electrical in your vehicle stops working, the first thing you should check for is a blown fuse. Determine from the chart on pages 473 and 474, or the diagram on the fuse box lid, which fuse or fuses control that device. Check those fuses first, but check all the fuses before deciding that a blown fuse is the cause. Replace any blown fuses, and check if the device works.

1. Turn the ignition switch to the LOCK (0) position. Make sure the headlights and all other accessories are off.
2. (Under-hood fuse boxes)
Remove the cover from the fuse box.

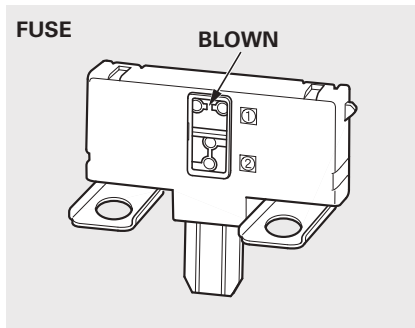

3. Check each of the large fuses in the under-hood fuse box by looking through the side window at the wire inside. Remove the screws with a Phillips-head screwdriver.

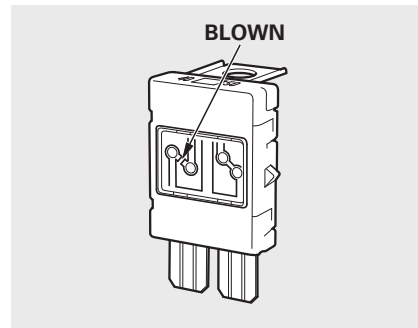

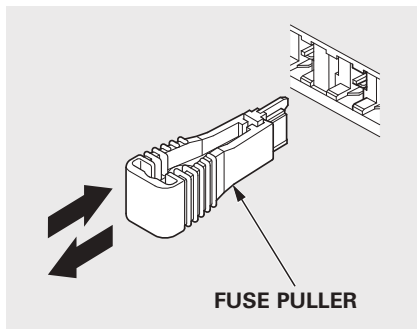

4. Check the smaller fuses in the under-hood fuse box and all the fuses in the interior fuse box by pulling out each one with the fuse puller provided on the back of the primary under-hood fuse box cover.

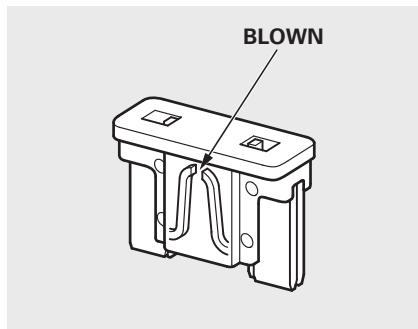

5. Look for a blown wire inside the fuse. If it is blown, replace it with one of the spare fuses of the same rating or lower. The spare fuses are provided on the back of the under-hood fuse cover.

If you cannot drive the vehicle without fixing the problem, and you do not have a spare fuse, take a fuse of the same rating or a lower rating from one of the other circuits. Make sure you can do without that circuit temporarily (such as the accessory power socket or radio).

If you replace the blown fuse with a spare fuse that has a lower rating, it might blow out again. This does not indicate that anything is wrong. Replace the fuse with one of the correct rating as soon as you can.

CONTINUED

Fuses

NOTICE

Replacing a fuse with one that has a higher rating greatly increases the chances of damaging the electrical system. If you do not have a replacement fuse with the proper rating for the circuit, install one with a lower rating.

6. If the replacement fuse of the same rating blows in a short time, there is probably a serious electrical problem in your vehicle. Leave the blown fuse in that circuit and have your vehicle checked by a qualified technician.

On models without navigation system
When the audio system is disabled, the clock setting in the audio system will be canceled. You will need to reset the clock (see page [293](#)).

On models with navigation system
If the navigation system fuse is removed, the navigation system will disable itself. The next time you turn on the ignition switch, the system will require you to enter a PIN before it can be used. Refer to the navigation system manual.

INTERIOR FUSE BOX

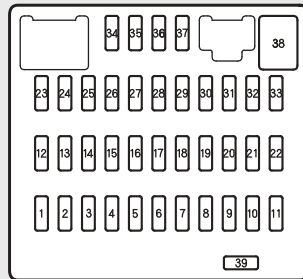

| No. | Amps. | Circuits Protected |
|-----|-------|------------------------------------|
| 1 | 7.5 A | Power Window / SH-AWD * |
| 2 | 20 A | Fuel Pump |
| 3 | 15 A | ACG |
| 4 | 7.5 A | ABS/VSA |
| 5 | 15 A | Heated Seat |
| 6 | 20 A | FR Fog Lights |
| 7 | 7.5 A | Driver's Power Seat Lumbar Support |
| 8 | 10A | RR Wiper |

| No. | Amps. | Circuits Protected |
|-----|-------|-------------------------|
| 9 | 7.5 A | OPDS |
| 10 | 7.5 A | Meter |
| 11 | 10 A | SRS |
| 12 | 10 A | Right Headlight High |
| 13 | 10 A | Left Headlight High |
| 14 | 7.5 A | Small Lights (Interior) |
| 15 | 15 A | Small Lights (Exterior) |
| 16 | 15 A | Right Headlight Low |
| 17 | 15 A | Left Headlight Low |

| No. | Amps. | Circuits Protected |
|-----|-------|--|
| 18 | 20 A | Headlight High Main |
| 19 | 20 A | Small Lights Main |
| 20 | 7.5 A | TPMS |
| 21 | 30 A | Headlight Low Main |
| 22 | - | Not Used |
| 23 | 7.5 A | Starter Diagnosis |
| 24 | 20 A | Moonroof |
| 25 | 20 A | Door Lock |
| 26 | 20 A | Driver's Power Window |
| 27 | - | Not Used |
| 28 | 15 A | Accessory Socket (Console Compartment) |
| 29 | 15 A | Accessory Socket (Front) |
| 30 | 20 A | Passenger's Power Window |
| 31 | 20 A | Radio Amplifier |
| 32 | 20 A | Right Rear Power Window |
| 33 | 20 A | Left Rear Power Window |
| 34 | - | Not Used |
| 35 | 7.5 A | Radio |
| 36 | 10 A | HAC |
| 37 | 7.5 A | Daytime Running Light |
| 38 | 30 A | FR Wiper |
| 39 | 7.5 A | STS |

*: SH-AWD models only

CONTINUED

Fuse Locations

UNDER-HOOD FUSE BOXES PRIMARY

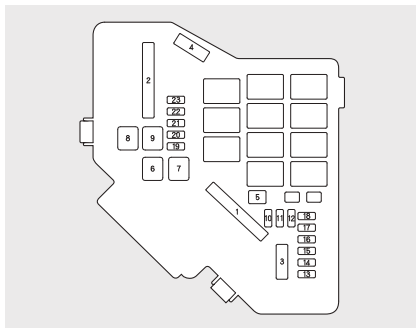

SECONDARY

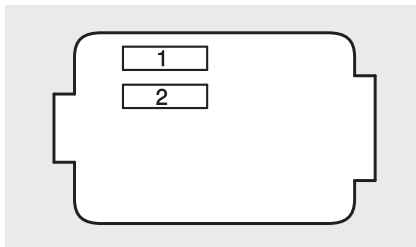

Primary Fuse Box

| No. | Amps. | Circuits Protected |
|-----|-------|----------------------------------|
| 1 | 100 A | Main Fuse |
| | 30 A | SH-AWD * |
| 2 | 80 A | Option Main |
| | 50 A | Ignition Switch Main |
| 3 | 40 A | ABS/VSA Motor |
| | 20 A | ABS/VSA Fail Safe |
| 4 | 50 A | Headlight Main |
| | 40 A | Power Window Main |
| 5 | 30 A | Passenger's Power Seat Reclining |
| 6 | 30 A | Main Fan Motor |
| 7 | 30A | Sub Fan Motor |
| 8 | 30A | Rear Defogger |
| 9 | 40A | Blower |
| 10 | 15A | Hazard |

Secondary Fuse Box

| No. | Amps. | Circuits Protected |
|-----|-------|----------------------------------|
| 1 | 7.5 A | Electric Vacuum Pump |
| 2 | 20A | Passenger's Power seat Reclining |

| No. | Amps. | Circuits Protected |
|-----|-------|--------------------------------|
| 11 | 15 A | LAF |
| 12 | 15 A | Stop & Horn |
| 13 | 20 A | Driver's Power Seat Reclining |
| 14 | 20 A | Driver's Power Seat Sliding |
| 15 | 7.5 A | IGPS Oil Level |
| 16 | 20 A | Passenger's Power Seat Sliding |
| 17 | 15 A | Electric Vacuum Pump |
| 18 | 15 A | IG Coil |
| 19 | 15 A | FI Main |
| 20 | 7.5 A | MG Clutch |
| 21 | 15 A | DBW |
| 22 | 7.5 A | Interior Light |
| 23 | 10 A | Back Up |

*: On SH-AWD models only

If your vehicle needs to be towed, call a professional towing service or organization. Never tow your vehicle with just a rope or chain. It is very dangerous.

(On SH-AWD models)

The only way you can safely tow your vehicle is with flat-bed equipment. The operator will load your vehicle on the back of a truck. Any other method of towing will damage the drive system. When you contact the towing agency, inform them a flat-bed is required.

NOTICE

Towing with only two tires on the ground will damage parts of the all-wheel-drive system. Your vehicle should be transported on a flat-bed truck or trailer.

(Except SH-AWD models)

There are two ways to tow your vehicle:

Flat-bed Equipment – The operator loads your vehicle on the back of a truck. **This is the best way to transport your vehicle.**

Wheel-lift Equipment – The tow truck uses two pivoting arms that go under the front tires and lift them off the ground. The rear tires remain on the ground. **This is an acceptable way to tow your vehicle.**

If, due to damage, your vehicle must be towed with the front wheels on the ground, do this:

- Start the engine.
- Press on the brake pedal. Move the shift lever through all its positions.
- Shift to D position for 5 seconds, then to N.
- Turn off the engine.
- Release the parking brake.
- Leave the ignition switch in the ACCESSORY (I) position so the steering wheel does not lock.

CONTINUED

Emergency Towing

NOTICE

Improper towing preparation will damage the transmission. Follow the above procedure exactly. If you cannot shift the transmission or start the engine, your vehicle must be transported with the front wheels off the ground.

With the front wheels on the ground, do not tow the vehicle more than 50 miles (80 km), and keep the speed below 35 mph (55 km/h).

NOTICE

Trying to lift or tow your vehicle by the bumpers will cause serious damage. The bumpers are not designed to support the vehicle's weight.

NOTICE

The steering system can be damaged if the steering wheel is locked. Leave the ignition switch in the ACCESSORY (I) position, and make sure the steering wheel turns freely before you begin towing.

The diagrams in this section give you the dimensions and capacities of your vehicle and the locations of the identification numbers. It also includes information you should know about your vehicle's tires and emissions control systems.

| | |
|---|-----|
| Identification Numbers | 478 |
| Specifications | 480 |
| DOT Tire Quality Grading (U.S. Vehicles) | 482 |
| Uniform Tire Quality Grading | 482 |
| Treadwear | 482 |
| Traction | 482 |
| Temperature | 483 |
| Tire Labeling | 484 |
| Tire Pressure Monitoring System (TPMS) – Required Federal Explanation | 485 |
| Emissions Controls | 487 |
| The Clean Air Act | 487 |
| Crankcase Emissions Control System | 487 |
| Evaporative Emissions Control System | 487 |
| Onboard Refueling Vapor Recovery | 488 |
| Exhaust Emissions Controls | 488 |
| Replacement Parts | 488 |

| | |
|-------------------------------------|-----|
| Three Way Catalytic Converter | 489 |
| Emissions Testing | 490 |

Identification Numbers

Your vehicle has several identifying numbers located in various places.

The vehicle identification number (VIN) is the 17-digit number your dealer uses to register your vehicle for warranty purposes. It is also necessary for licensing and insuring your vehicle. The easiest place to find the VIN is on a plate fastened to the top of the dashboard. You can see it by looking through the windshield on the driver's side. It is also on the certification label attached to the driver's doorjamb, and is stamped on the engine compartment bulkhead. The VIN is also provided in bar code on the certification label.

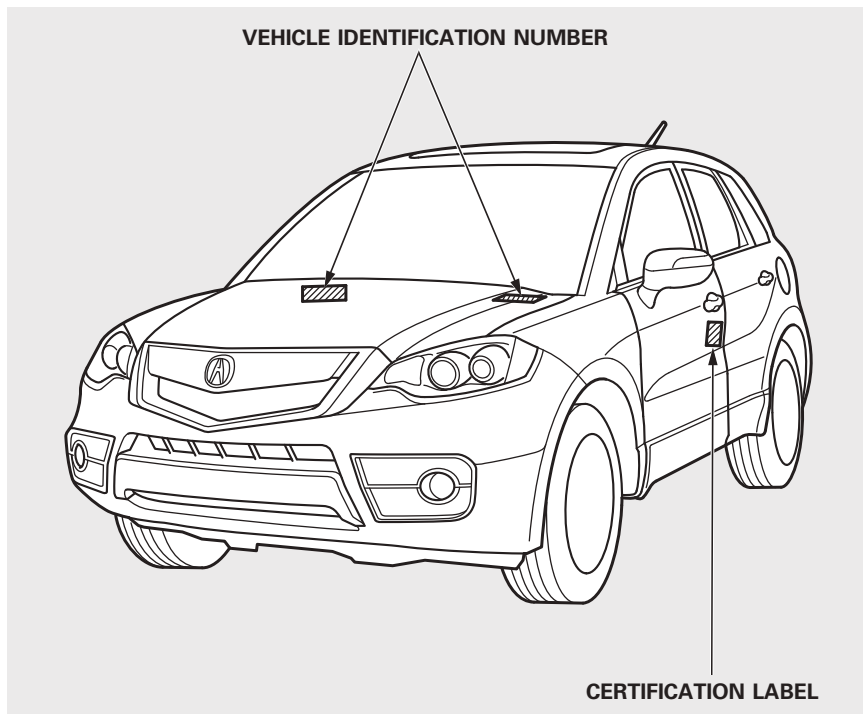

The engine number is stamped into the front of the engine block.

The transmission number is on a label on top of the transmission.

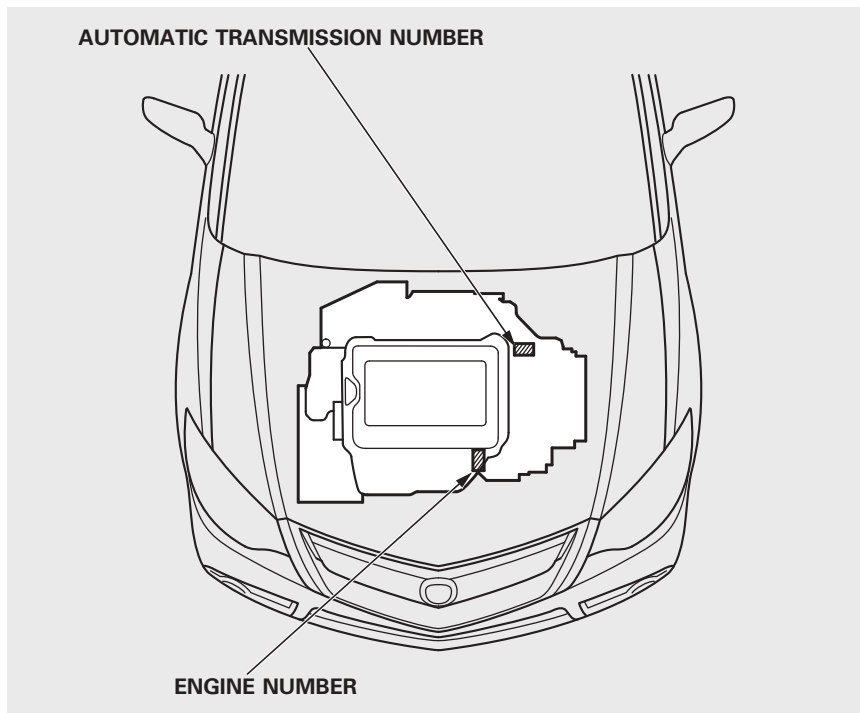

Specifications

Dimensions

| | |
|-----------|---------------------|
| Length | 182.5 in (4,635 mm) |
| Width | 73.6 in (1,870 mm) |
| Height | 65.2 in (1,655 mm) |
| Wheelbase | 104.3 in (2,650 mm) |
| Track | 61.9 in (1,572 mm) |
| | Front |
| | Rear |
| | 62.6 in (1,590 mm) |

Weights

| | |
|-----------------------------|--|
| Gross vehicle weight rating | See the certification label attached to the driver's doorjamb. |
|-----------------------------|--|

Engine

| | |
|-------------------|--|
| Type | Water cooled 4-stroke DOHC i-VTEC 4 cylinder gasoline engine with turbo charger, intercooler |
| Bore x Stroke | 3.39 x 3.90 in (86.0 x 99.0 mm) |
| Displacement | 140.3 cu-in (2,300 cm ³) |
| Compression ratio | 8.8 |
| Spark plugs | SILKR8A-S (NGK) |

Seating Capacities

| | |
|-------|---|
| Total | 5 |
| Front | 2 |
| Rear | 3 |

Capacities

| | | |
|-------------------------------|----------------------|-------------------------------|
| Fuel tank | | Approx. 18.0 US gal (68 L) |
| Engine oil | Change* ¹ | |
| | Including filter | 5.0 US qt (4.7 L) |
| | Without filter | 4.8 US qt (4.5 L) |
| | Total | 6.1 US qt (5.8 L) |
| Engine coolant | Change* ² | 1.85 US gal (7.0 L) |
| | Total | 2.22 US gal (8.4 L) |
| Automatic transmission fluid | Change | |
| | 2WD | 3.0 US qt (2.8 L) |
| | 4WD | 3.1 US qt (2.9 L) |
| | Total | |
| | 2WD | 8.8 US qt (8.3 L) |
| | 4WD | 8.2 US qt (7.8 L) |
| Rear differential fluid (4WD) | Change | 2.67 US qt (2.53 L) |
| | Total | 2.93 US qt (2.77 L) |
| Transfer assembly fluid (4WD) | Change | 0.45 US qt (0.43 L) |
| | Total | 0.48 US qt (0.45 L) |
| Windshield washer reservoir | U.S. Vehicles | 2.6 US qt (2.5 L) |
| | Canada Vehicles | 4.8 US qt (4.5 L) |
| | | |

*1: Excluding the oil remaining in the engine

*2: Including the coolant in the reserve tank and that remaining in the engine
Reserve tank capacity:
0.18 US gal (0.7 L)

Lights

| | | |
|----------------------------------|------|--------------------------|
| Headlights | High | 12 V – 60 W (HB3) |
| | Low* | 12 V – 35 W (D2S) |
| Front turn signal/parking lights | | 12 V – 24/2.2 CP (Amber) |
| Front fog lights | | 12 V – 55 W (H11) |
| Front side marker lights | | 12 V – 3 CP |
| Rear turn signal lights | | 12 V – 21 W |
| Brake/Taillights (in fenders) | | 12 V – 21/5 W |
| Taillights (in tailgate) | | 12 V – 3 CP |
| Back-up lights | | 12 V – 21 W |
| Rear side marker lights | | 12 V – 2 CP |
| License plate lights | | 12 V – 3 CP |
| High-mount brake light | | 12 V – 16 W |
| Front ceiling lights/Spotlights | | 12 V – 4 CP |
| Rear ceiling light | | 12 V – 8 W |
| Glove box light | | 14 V – 1.4 W |
| Console compartment light | | 14 V – 1.4 W |
| Vanity mirror lights | | 12 V – 2 W |
| Door courtesy lights | | 12 V – 2 CP |
| Cargo area light | | 12 V – 5 W |

*: The low beam headlights are high voltage discharged type. Replacement of a low beam headlight bulb should be performed by your dealer.

Air Conditioning

| | |
|------------------|--------------------------|
| Refrigerant type | HFC-134a (R-134a) |
| Charge quantity | 15.9–17.6 oz (450–500 g) |
| Lubricant type | SP-10 |

Battery

| | |
|----------|--------------------|
| Capacity | 12 V – 52 AH/5 HR |
| | 12 V – 65 AH/20 HR |

Fuses

| | |
|------------|---|
| Interior | See page 473 or the fuse label attached to the dashboard. |
| Under-hood | See page 474 or the fuse box covers. |

Alignment

| | | |
|--------|-------|------------------|
| Toe-in | Front | 0.0 in (0 mm) |
| | Rear | 0.10 in (2.5 mm) |
| Camber | Front | 0° 10' |
| | Rear | –1° |
| Caster | Front | 2° 57' |

Tires

| | | |
|----------|------------|--|
| Size | Front/Rear | P235/55R18 99V |
| | Spare | T165/80D17 104M |
| Pressure | Front/Rear | 32 psi (220 kPa, 2.2 kgf/cm ²) |
| | Spare | 60 psi (420 kPa, 4.2 kgf/cm ²) |

DOT Tire Quality Grading (U.S. Vehicles)

The tires on your vehicle meet all U. S. Federal Safety Requirements. All tires are also graded for treadwear, traction, and temperature performance according to Department of Transportation (DOT) standards. The following explains these gradings.

Uniform Tire Quality Grading

Quality grades can be found where applicable on the tire sidewall between tread shoulder and maximum section width. For example:

Treadwear 200

Traction AA

Temperature A

All passenger car tires must conform to Federal Safety Requirements in addition to these grades.

Treadwear

The treadwear grade is a comparative rating based on the wear rate of the tire when tested under controlled conditions on a specified government test course. For example, a tire graded 150 would wear one and one-half (1 1/2) times as well on the government course as a tire graded 100. The relative performance of tires depends upon the actual conditions of their use, however, and may depart significantly from the norm due to variations in driving habits, service practices and differences in road characteristics and climate.

Traction

The traction grades, from highest to lowest, are AA, A, B, and C. Those grades represent the tire's ability to stop on wet pavement as measured under controlled conditions on specified government test surfaces of asphalt and concrete. A tire marked C may have poor traction performance.

Warning: The traction grade assigned to this tire is based on straight-ahead braking traction tests, and does not include acceleration, cornering, hydroplaning, or peak traction characteristics.

Temperature

The temperature grades are A (the highest), B, and C, representing the tire's resistance to the generation of heat and its ability to dissipate heat when tested under controlled conditions on a specified indoor laboratory test wheel. Sustained high temperature can cause the material of the tire to degenerate and reduce tire life, and excessive temperature can lead to sudden tire failure. The grade C corresponds to a level of performance which all passenger car tires must meet under the Federal Motor Vehicle Safety Standard No. 109. Grades B and A represent higher levels of performance on the laboratory test wheel than the minimum required by law.

Warning: The temperature grade for this tire is established for a tire that is properly inflated and not overloaded. Excessive speed, underinflation, or excessive loading, either separately or in combination, can cause heat buildup and possible tire failure.

Tire Labeling

The tires that came on your vehicle have a number of markings. Those you should be aware of are described below.

TIRE LABELING EXAMPLE

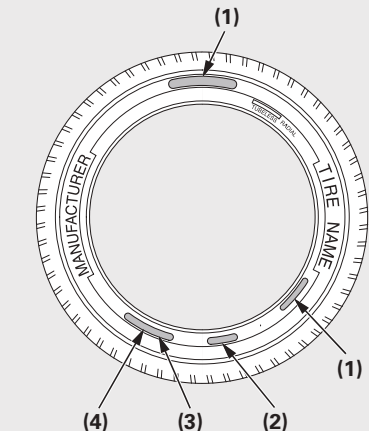

- (1) Tire Size
 (2) Tire Identification Number (TIN)
 (3) Maximum Tire Pressure
 (4) Maximum Tire Load

Tire Size

Whenever tires are replaced, they should be replaced with tires of the same size. Below is an example of tire size with an explanation of what each component means.

P235/55R18 99V

- P – Vehicle type (P indicates passenger vehicle).
 235 – Tire width in millimeters.
 55 – Aspect ratio (the tire's section height as a percentage of its width).
 R – Tire construction code (R indicates radial).
 18 – Rim diameter in inches.
 99 – Load index (a numerical code associated with the maximum load the tire can carry).
 V – Speed symbol (an alphabetical code indicating the maximum speed rating).

Tire Identification Number (TIN)

The tire identification number (TIN) is a group of numbers and letters that look like the following example. TIN is located on the sidewall of the tire.

DOT B97R FW6X 2202

- DOT – This indicates that the tire meets all requirements of the U.S. Department of Transportation.
 B97R – Manufacturer's identification mark.
 FW6X – Tire type code.
 2202 – Date of manufacture.
 └─ year
 └─ week

Tire Labeling, Tire Pressure Monitoring System (TPMS) – Required Federal Explanation

Glossary of Tire Terminology

Cold Tire Pressure – The tire air pressure when the vehicle has been parked for at least three hours or driven less than 1 mile (1.6 km).

Load Rating – Means the maximum load that a tire is rated to carry for a given inflation pressure.

Maximum Inflation Pressure – The maximum tire air pressure that the tire can hold.

Maximum Load Rating – Means the load rating for a tire at the maximum permissible inflation pressure for that tire.

Recommended Inflation Pressure – The cold tire inflation pressure recommended by the manufacturer.

Treadwear Indicators (TWI) – Means the projections within the principal grooves designed to give a visual indication of the degrees of wear of the tread.

Tire Pressure Monitoring System (TPMS) – Required Federal Explanation

Each tire, including the spare (if provided), should be checked monthly when cold and inflated to the inflation pressure recommended by the vehicle manufacturer on the vehicle placard or tire inflation pressure label.

(If your vehicle has tires of a different size than the size indicated on the vehicle placard or tire inflation pressure label, you should determine the proper tire inflation pressure for those tires.)

As an added safety feature, your vehicle has been equipped with a tire pressure monitoring system (TPMS) that illuminates a low tire pressure telltale



when one or more of your tires is significantly under-inflated

Accordingly, when the low tire pressure telltale illuminates, you should stop and check your tires as soon as possible, and inflate them to the proper pressure.

CONTINUED

Tire Pressure Monitoring System (TPMS) – Required Federal Explanation

Driving on a significantly under inflated tire causes the tire to overheat and can lead to tire failure. Underinflation also reduces fuel efficiency and tire tread life, and may affect the vehicle's handling and stopping ability.

Please note that the TPMS is not a substitute for proper tire maintenance, and it is the driver's responsibility to maintain correct tire pressure, even if under-inflation has not reached the level to trigger illumination of the TPMS low tire pressure telltale.

Your vehicle has also been equipped with a TPMS malfunction indicator to indicate when the system is not operating properly. The TPMS malfunction indicator is combined with the low tire pressure telltale. When the system detects a malfunction, the telltale will flash for approximately one minute and then remain continuously illuminated. This sequence will continue upon subsequent vehicle start-ups as long as the malfunction exists.

When the malfunction indicator is illuminated, the system may not be able to detect or signal low tire pressure as intended.

TPMS malfunctions may occur for a variety of reasons, including the installation of replacement or alternate tires or wheels on the vehicle that prevent the TPMS from functioning properly.

Always check the TPMS malfunction telltale after replacing one or more tires or wheels on your vehicle to ensure that the replacement or alternate tires and wheels allow the TPMS to continue to function properly.

The burning of gasoline in your vehicle's engine produces several by-products. Some of these are carbon monoxide (CO), oxides of nitrogen (NOx), and hydrocarbons (HC). Gasoline evaporating from the tank also produces hydrocarbons. Controlling the production of NOx, CO, and HC is important to the environment. Under certain conditions of sunlight and climate, NOx and HC react to form photochemical "smog." Carbon monoxide does not contribute to smog creation, but it is a poisonous gas.

The Clean Air Act

The United States Clean Air Act* sets standards for automobile emissions. It also requires that automobile manufacturers explain to owners how their emissions controls work and what to do to maintain them. This section summarizes how the emissions controls work. Scheduled maintenance is on page [418](#).

* In Canada, Acura vehicles comply with the Canadian emission requirements, as specified in an agreement with Environment Canada, at the time they are manufactured.

Crankcase Emissions Control System

Your vehicle has a positive crankcase ventilation system. This keeps gasses that build up in the engine's crankcase from going into the atmosphere. The positive crankcase ventilation valve routes them from the crankcase back to the intake manifold. They are then drawn into the engine and burned.

Evaporative Emissions Control System

As gasoline evaporates in the fuel tank, an evaporative emissions control canister filled with charcoal adsorbs the vapor. It is stored in this canister while the engine is off. After the engine is started and warmed up, the vapor is drawn into the engine and burned during driving.

Emissions Controls

Onboard Refueling Vapor Recovery

The onboard refueling vapor recovery (ORVR) system captures the fuel vapors during refueling. The vapors are adsorbed in a canister filled with activated carbon. While driving, the fuel vapors are drawn into the engine and burned off.

Exhaust Emissions Controls

The exhaust emissions controls include three systems: PGM-FI, ignition timing control, and three way catalytic converter. These three systems work together to control the engine's combustion and minimize the amount of HC, CO, and NOx that come out the tailpipe. The exhaust emissions control systems are separate from the crankcase and evaporative emissions control systems.

PGM-FI System

The PGM-FI system uses sequential multiport fuel injection. It has three subsystems: air intake, engine control, and fuel control. The powertrain control module (PCM) uses various sensors to determine how much air is going into the engine. It then controls how much fuel to inject under all operating conditions.

Ignition Timing Control System

This system constantly adjusts the ignition timing, reducing the amount of HC, CO, and NOx produced.

Three Way Catalytic Converter

The three way catalytic converter is in the exhaust system. Through chemical reactions, it converts HC, CO, and NOx in the engine's exhaust to carbon dioxide (CO₂), nitrogen (N₂), and water vapor.

Replacement Parts

The emissions control systems are designed and certified to work together in reducing emissions to levels that comply with the Clean Air Act. To make sure the emissions remain low, you should use only new Acura replacement parts or their equivalent for repairs. Using lower quality parts may increase the emissions from your vehicle.

The emissions control systems are covered by warranties separate from the rest of your vehicle. Read your warranty manual for more information.

Three Way Catalytic Converter

The three way catalytic converters contain precious metals that serve as catalysts, promoting chemical reactions to convert the exhaust gasses without affecting the metals. The catalytic converters are referred to as three-way catalysts, since they act on HC, CO, and NOx. Replacement units must be original Acura parts or their equivalent.

The three way catalytic converter must operate at a high temperature for the chemical reactions to take place. It can set on fire any combustible materials that come near it. Park your vehicle away from high grass, dry leaves, or other flammables.

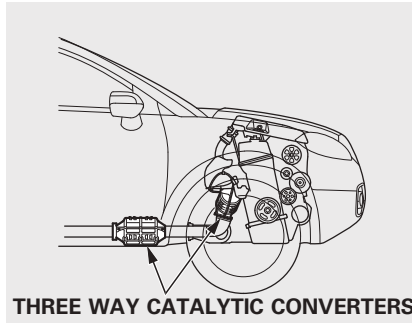

A defective three way catalytic converter contributes to air pollution, and can impair your engine's performance. Follow these guidelines to protect your vehicle's three way catalytic converter.

- Keep the engine well maintained.
 - Have your vehicle diagnosed and repaired if it is misfiring, backfiring, stalling, or otherwise not running properly.
- Always use unleaded gasoline. Even a small amount of leaded gasoline can contaminate the catalyst metals, making the three way catalytic converter ineffective.

Emissions Testing

Testing of Readiness Codes

If you take your vehicle for an emissions test shortly after the battery has been disconnected or gone dead, it may not pass the test. This is because of certain “readiness codes” that must be set in the on-board diagnostics for the emissions systems. These codes are erased when the battery is disconnected, and set again only after several days of driving under a variety of conditions.

If the testing facility determines that the readiness codes are not set, you will be requested to return at a later date to complete the test. If you must get the vehicle retested within the next two or three days, you can condition the vehicle for retesting by doing the following.

1. Make sure the gas tank is nearly, but not completely, full (around 3/4).
2. Make sure the vehicle has been parked with the engine off for 6 hours or more.
3. Make sure the ambient temperature is between 40° and 95°F (4° and 35°C).
4. Without touching the accelerator pedal, start the engine, and let it idle for 20 seconds.
5. Keep the vehicle in Park. Increase the engine speed to 2,000 rpm, and hold it there until the temperature gauge rises to at least 1/4 of the scale (about 3 minutes).
6. Without touching the accelerator pedal, let the engine idle for 20 seconds.
7. Drive your vehicle for 30 seconds while accelerating.

8. Select a nearby lightly traveled major highway where you can maintain a speed of 50 to 60 mph (80 to 100 km/h) for at least 20 minutes. Drive on the highway in D. Do not use the cruise control. When traffic allows, drive for 90 seconds without moving the accelerator pedal. (Vehicle speed may vary slightly; this is okay.) If you cannot do this for a continuous 90 seconds because of traffic conditions, drive for at least 30 seconds, then repeat it two more times (for a total of 90 seconds).

9. Then drive in city/suburban traffic for at least 10 minutes. When traffic conditions allow, let the vehicle coast for several seconds without using the accelerator pedal or the brake pedal.
10. Make sure the vehicle has been parked with the engine off for 30 minutes.

If the testing facility determines the readiness codes are still not set, see your dealer.

[Main Menu](#)

[Table of Contents](#)

Warranty and Client Relations

| | |
|---|-----|
| Client Service Information..... | 494 |
| Warranty Coverages | 495 |
| Reporting Safety Defects (U.S. Vehicles) | 496 |
| Authorized Manuals..... | 497 |

Client Service Information

Acura dealership personnel are trained professionals. They should be able to answer all your questions. If you encounter a problem that your dealership does not solve to your satisfaction, please discuss it with the dealership's management. The service manager or general manager can help. Almost all problems are solved in this way.

If you are dissatisfied with the decision made by the dealership's management, contact Acura Client Services.

U.S. Owners:

American Honda Motor Co., Inc.
Acura Client Services
Mail Stop 500-2N-7E
1919 Torrance Blvd.
Torrance, CA 90501-2746

Tel: (800) 382-2238

Canadian Owners:
Acura Client Services
Honda Canada Inc.

Visit www.acura.ca for contact information

Tel: 1-888-9-ACURA-9

Fax: 1-877-939-0909

In Puerto Rico and the U.S. Virgin Islands:

Vortex Motor Corp.
Bella International
P.O. Box 190816
San Juan, PR 00919-0816

Tel: (787) 620-7546

When you call or write, please give us this information:

- Vehicle Identification Number (see page 478)
- Name and address of the dealer who services your vehicle
- Date of purchase
- Odometer reading of your vehicle
- Your name, address, and telephone number
- A detailed description of the problem
- Name of the dealer who sold the vehicle to you

U.S. Owners

Your new vehicle is covered by these warranties:

New Vehicle Limited Warranty – covers your new vehicle, except for the battery, emissions control systems, and accessories against defects in materials and workmanship.

Emissions Control Systems Defects Warranty and Emissions Performance Warranty

– these two warranties cover your vehicle's emissions control systems. Time, mileage, and coverage are conditional. Please read your warranty booklet for exact information.

Original Equipment Battery Limited Warranty – this warranty gives up to 100% credit toward a replacement battery.

Seat Belt Limited Warranty – a seat belt that fails to function properly is covered by a limited warranty. Please read your warranty booklet for details.

Rust Perforation Limited Warranty – all exterior body panels are covered for rust-through from the inside for the specified time period with no mileage limit.

Accessory Limited Warranty – Acura accessories are covered under this warranty. Time and mileage limits depend on the type of accessory and other factors. Please read your warranty manual for details.

Replacement Parts Limited Warranty – covers all Acura replacement parts against defects in materials and workmanship.

Replacement Battery Limited Warranty – provides prorated coverage for a replacement battery purchased from your dealer.

Replacement Muffler Lifetime Limited Warranty – provides coverage for as long as the purchaser of the muffler owns the vehicle.

Restrictions and exclusions apply to all these warranties. Please read the 2010 Acura warranty information booklet that came with your vehicle for precise information on warranty coverages. Your vehicle's original tires are covered by their manufacturer. Tire warranty information is in a separate booklet.

Canadian Owners

Please refer to the 2010 warranty manual that came with your vehicle.

Reporting Safety Defects (U.S. Vehicles)

If you believe that your vehicle has a defect which could cause a crash or could cause injury or death, you should immediately inform the National Highway Traffic Safety Administration (NHTSA) in addition to notifying American Honda Motor Co., Inc.

If NHTSA receives similar complaints, it may open an investigation, and if it finds that a safety defect exists in a group of vehicles, it may order a recall and remedy campaign. However, NHTSA cannot become involved in individual problems between you, your dealer, or American Honda Motor Co., Inc.

To contact NHTSA, you may call the Vehicle Safety Hotline toll-free at 1-888-327-4236 (TTY: 1-800-424-9153); go to <http://www.safercar.gov>; or write to: Administrator, NHTSA, 1200 New Jersey Avenue, SE., Washington, DC 20590. You can also obtain other information about motor vehicle safety from <http://www.safercar.gov>.

Purchasing Factory Authorized Manuals (U.S. only)

The publications shown below can be purchased from Helm Incorporated. You can order by phone or online:

- Call Helm Inc. at 1-800-782-4356 (credit card orders only)
- Go online at www.helminc.com

If you are interested in other years or models, contact Helm Inc. at 1-800-782-4356.

| Publication Form Number | Form Description |
|-------------------------|---|
| 61STK03 | 2007-2010 Acura RDX Service Manual |
| 61STK03EL | 2010 Acura RDX Electrical Troubleshooting Manual |
| 61STK30 | 2007 Model series Acura RDX Body Repair Manual |
| 31STK630 | 2010 Acura RDX Owner's Manual |
| 31STK830 | 2010 Acura RDX Navigation System Manual |
| 31STKM30 | 2010 Acura RDX Maintenance Journal |
| 31STKQ30 | 2010 Acura RDX Advanced Technology Guide |
| ACU-R | Order Form for Previous Years- Indicate Year and Model Desired |

Service Manual:

Covers maintenance and recommended procedures for repair to engine and chassis components. It is written for the journeyman mechanic, but it is simple enough for most mechanically inclined owners to understand.

Electrical Troubleshooting Manual:

Complements the Service Manual by providing in-depth troubleshooting information for each electrical circuit in your vehicle.

Body Repair Manual:

Describes the procedures involved in the replacement of damaged body parts.

A

| | |
|---|----------|
| Accessories and Modifications | 362 |
| ACCESSORY (Ignition Key Position) | 125 |
| Accessory Power Sockets | 157 |
| AcuraLink® (U.S. models only) | 332 |
| Additives, Engine Oil | 421 |
| Adjusting the Sound | 177, 224 |
| Adjusting the Steering Wheel | 122 |
| Advanced Airbags | 28 |
| Air Conditioning System | 164 |
| Usage | 165 |
| Air Pressure, Tires | 444, 445 |
| Airbag (SRS) | 10, 24 |
| Alcohol in Gasoline | 352 |
| Anti-lock Brakes (ABS) Indicator Light | 66, 388 |
| Operation | 388 |
| Anti-theft Steering Column Lock | 125 |
| Anti-theft, Audio System | 292 |
| Antifreeze | 424 |

| | |
|---|----------|
| Armrests | 138 |
| Audio Antenna | 439 |
| Audio System | 172, 216 |
| Automatic Lighting Off Feature | 118 |
| Automatic Seat Belt Tensioners ... | 22 |
| Automatic Speed Control | 300 |
| Automatic Transmission | 376 |
| Capacity, Fluid | 480 |
| Checking Fluid Level | 427 |
| Driving with the Paddle Shifters | 380 |
| Shift Lever Position Indicators | 376 |
| Shift Lever Positions | 377 |
| Shift Lock Release | 379 |
| Shifting | 376 |
| Auxiliary Input Jack | 291 |

B

| | |
|---|---------|
| Battery Charging System Indicator | 65, 465 |
| Jump Starting | 461 |

| | |
|--|----------|
| Maintenance | 450 |
| Specifications | 481 |
| Before Driving | 351 |
| Belts, Seat | 9, 20 |
| Beverage Holders | 156 |
| <i>Bluetooth</i> ® Audio | 212, 280 |
| <i>Bluetooth</i> ® HandsFreeLink® | 306 |
| Booster Seats | 54 |
| Brakes Anti-lock Brakes (ABS) | 388 |
| Break-in, New Linings | 352 |
| Bulb Replacement | 433 |
| Fluid | 429 |
| Parking | 150 |
| System Design | 387 |
| System Indicator (Amber) | 468 |
| System Indicator (Red) | 467 |
| Wear Indicators | 387 |
| Braking System | 387 |
| Break-in, New Vehicle | 352 |
| Brightness Control, Instruments | 120 |

CONTINUED

D

| | |
|----------------------------------|----------|
| DANGER, Explanation of | iii |
| Dashboard | 3, 62 |
| Daytime Running Lights | 119 |
| Dead Battery | 461 |
| Defects, Reporting Safety | 496 |
| Defogger, Rear Window | 121 |
| Defrosting the Windows | 167 |
| Dimensions | 480 |
| Dimming the Headlights | 116 |
| Dipstick | |
| Automatic Transmission | 427 |
| Engine Oil | 356 |
| Directional Signals | 69, 116 |
| Disc Brake Wear Indicators | 387 |
| Disc Care | 257 |
| Disc Changer | 185, 239 |
| Disc Changer Error | |
| Messages | 195, 255 |
| Disc Player | 185, 239 |
| Disposal of Used Oil | 423 |
| Doors | |
| Childproof Door Locks | 127 |
| Locking and Unlocking | 126 |

| | |
|--|-----|
| Power Door Locks | 126 |
| DOT Tire Quality Grading (U.S. Vehicles) | 482 |
| Driver and Passenger Safety | 5 |
| Driving | 371 |
| Economy | 358 |
| Driving Guidelines | 372 |
| Driving Position Memory | |
| System | 148 |
| Driving with the Paddle Shifters | 380 |
| Dust and Pollen Filter | 439 |

E

| | |
|--------------------------------|----------|
| Economy, Fuel | 358 |
| Emergencies on the Road | 453 |
| Battery, Jump Starting | 461 |
| Brake System Indicator ... | 467, 468 |
| Changing a Flat Tire | 455 |
| Charging System | |
| Indicator | 65, 465 |
| Checking the Fuses | 470 |
| Driving with a Flat Tire | 454 |
| Hazard Warning Flashers | 121 |

| | |
|------------------------------|---------|
| Jump Starting | 461 |
| Low Oil Pressure | |
| Indicator | 65, 465 |
| Malfunction Indicator | |
| Lamp | 65, 466 |
| Overheated Engine | 463 |
| Towing | 475 |
| Emergency Brake | 150 |
| Emergency Flashers | 121 |
| Emergency Towing | 475 |
| Emissions Controls | 487 |
| Emissions Testing | 490 |
| Engine | |
| Adding Engine Coolant | 424 |
| If it Won't Start | 459 |
| Malfunction Indicator | |
| Lamp | 65, 466 |
| Oil Life Indicator | 411 |
| Oil Pressure Indicator | 65, 465 |
| Overheating | 463 |
| Specifications | 480 |
| Speed Limiter | 378 |
| Starting | 374 |
| Engine Coolant | 424 |
| Engine Number | 479 |

CONTINUED

Index

| | |
|---|-----|
| Ethanol in Gasoline | 352 |
| Evaporative Emissions | |
| Controls | 487 |
| Exhaust Emissions Controls | 488 |
| Exhaust Fumes | 57 |
| Expectant Mothers, Use of Seat Belts by | 18 |

F

| | |
|--------------------------------|-----|
| Fan, Interior | 166 |
| Features | 163 |
| Filters | |
| Dust and Pollen | 439 |
| Oil | 422 |
| Flashers, Hazard Warning | 121 |
| Flat Tire, Changing a | 455 |
| Floor Mats | 438 |
| Fluids | |
| Automatic Transmission | 427 |
| Brake | 429 |
| Location | 419 |
| Power Steering | 430 |
| Windshield Washer | 426 |
| FM/AM Radio Reception | 287 |

| | |
|-----------------------------------|--------|
| Fog Lights | 119 |
| Folding the Rear Seats Down | 138 |
| Four-way Flashers | 121 |
| Front Airbags | 10, 26 |
| Front Door Pockets | 155 |
| Front Seat | |
| Heaters | 141 |
| Front Seat Power | |
| Adjustments | 134 |
| Fuel | 352 |
| Economy | 358 |
| Fill Door and Cap | 353 |
| Gauge | 73 |
| Low Fuel Indicator | 68 |
| Octane Requirement | 352 |
| Reserve Indicator | 68 |
| Tank, Filling the | 353 |
| Tighten Fuel Cap | 354 |
| Fuel Economy | 358 |
| Fuses, Checking the | 470 |

G

| | |
|------------------------------|-----|
| Gas Mileage, Improving | 359 |
| Gas Station Procedures | 353 |

| | |
|--|----------|
| Gasoline | 352 |
| Low Fuel Indicator | 68 |
| Octane Requirement | 352 |
| Tank, Refueling | 353 |
| Gauges | |
| Fuel | 73 |
| Speedometer | 73 |
| Tachometer | 73 |
| Turbo Boost Meter | 73 |
| Gearshift Lever Positions | |
| Automatic | |
| Transmission | 376, 377 |
| Glove Box | 155 |
| Gross Axle Weight Rating (GAWR) | 397 |
| Gross Vehicle Weight Rating (GVWR) | 397 |

H

| | |
|-------------------------------|-----|
| HandsFreeLink® | 306 |
| Hazard Warning Flashers | 121 |
| Head Restraints | 135 |
| Headlights | |
| Aiming | 431 |

Index

Introduction i
 iPod Error Messages 203, 269
 iPod® 197, 260

J

Jack, Tire 455
 Jacking up the Vehicle 455
 Jump Starting 461

K

Keyless Memory Settings 133
 Keys 122

L

Label, Certification 478
 Lane Change, Signaling 116
 Lap/Shoulder Belt 15, 21
 LATCH Anchorage System 46
 Lights
 Bulb Replacement 431
 Indicator 63

Interior 151
 Parking 116
 Turn Signal 116
 Load Limit 365, 397
 LOCK (Ignition Key Position) 125
 Locks
 Anti-theft Steering Column 125
 Childproof Door 127
 Fuel Fill Door 353
 Glove Box 155
 Lockout Prevention 127
 Power Door 126
 Tailgate 128
 Low Coolant Level 357
 Low Fuel Indicator 68
 Low Oil Pressure
 Indicator 65, 465
 Low Tire Pressure/TPMS
 Indicator 71, 390
 Lower Anchors 46
 Lubricant Specifications Chart ... 480
 Luggage, Storing (cargo) 364

M

Maintenance 409
 Main Items and Sub Items 415
 Minder 411
 Owner's Maintenance
 Checks 417
 Safety 410
 Schedule 418
 Malfunction Indicator
 Lamp 65, 466
 Memory, Driving Position 148
 Meters, Gauges 73
 Methanol in Gasoline 352
 Mirrors, Adjusting 146
 Modifications 363
 Modifying Your Vehicle 363
 Moonroof 144
 Multi-Information Display 74

N

Neutral Gear Position 377
 New Vehicle Break-in 352
 NOTICE, Explanation of i

Numbers, Identification 478

O

Octane Requirement,
 Gasoline 352
 Odometer 76
 Odometer, Trip 76
 Off-Highway Driving
 Guidelines 405
 Off-Road Precautions 405
 Oil
 Change, How to 422
 Change, When to 411
 Checking Engine 356
 Life, Engine 411
 Pressure Indicator 65, 465
 Selecting Proper Viscosity
 Chart 420
 ON (Ignition Key Position) 125
 Onboard Refueling Vapor
 Recovery 488
 Outside Mirrors 146
 Outside Temperature 76
 Overheating, Engine 463

Owner's Maintenance Checks 417
 Oxygenated Fuels 352

P

Panel Brightness Control 120
 Park Gear Position 377
 Parking 386
 Parking Brake 150
 Parking Brake and Brake System
 Indicator 467
 Parking Lights 116
 Parking Over Things that
 Burn 386, 489
 Passenger Airbag Off Indicator 33
 PGM-FI System 488
 Playing a USB Flash Memory
 Device 204, 270
 Playing an iPod 197, 260
 Playing the FM/AM
 Radio 174, 217
 Playing the XM® Radio 179, 228
 Pollen Filter 439
 Power Door Locks 126
 Power Seat Adjustments 134

Power Socket Locations 157
 Power Steering Fluid 430
 Power Windows 142
 Pregnancy, Using Seat Belts 18
 Preparing to Drive 373
 Proper Seat Belt Usage 15
 Protecting Adults and Teens 12
 Additional Safety Precautions ... 19
 Advice for Pregnant Women 18
 Protecting Children 36
 General Guidelines 36
 Protecting Infants 41
 Protecting Larger Children 53
 Protecting Small Children 42
 Using Child Seats with
 Tethers 51
 Using LATCH 46

R

Radiator Overheating 463
 Radio Theft Protection 292
 Radio/CD Sound System 172
 Readiness Codes 490

CONTINUED

USB Flash Memory Device Error
 Messages 211, 279
 Used Oil, How to Dispose of 423

V

Vanity Mirror 158
 Vehicle Capacity Load 365
 Vehicle Dimensions 480
 Vehicle Identification Number ... 478
 Vehicle Stability Assist (VSA)
 System 395
 VSA Activation Indicator 69
 VSA System Indicator 68
 Vehicle Storage 452
 VIN 478
 Viscosity, Oil 420

W

Warning Labels, Location of 58
 WARNING, Explanation of iii
 Warranty Coverages (U.S.
 only) 495

Washer, Windshield
 Checking the Fluid Level 426
 Operation 114
 Wheels 443
 Adjusting the Steering 122
 Alignment and Balance 447
 Compact Spare 454
 Wrench, Nut 455
 Windows
 Auto Reverse 143
 Operating the Power 142
 Rear, Defogger 121
 Windshield
 Cleaning 114
 Defroster 167
 Washers 114, 426
 Wipers, Windshield
 Changing Blades 440
 Operation 114
 Rear Windshield Wiper and
 Washer 115
 Worn Tires 445
 Wrecker, Emergency Towing 475

X

XM® Radio 179, 228

Service Information Summary

Gasoline:

Premium unleaded gasoline, pump octane number of 91 or higher.

NOTICE

Avoid driving with an extremely low fuel level. Running out of fuel could cause the engine to misfire, damaging the catalytic converter.

Fuel Tank Capacity:

18.0 US gal (68 L)

Required Engine Oil:

Always use Mobil 1[®] 5W-30 or an equivalent oil that meets the Acura HTO-06 standard.

Oil change capacity (including filter):

5.0 US qt (4.7 L)

Automatic Transmission Fluid:

Acura ATF-Z1
(automatic transmission fluid)
(see page [427](#)).

On models with SH-AWD

Rear Differential Fluid:

Use Acura ATF-Z1
(automatic transmission fluid)
only.

Capacity:

SH-AWD differential case
2.67 US qt (2.53 L)

On models with SH-AWD

Transfer Assembly Fluid:

SAE 90 or SAE 80W-90 viscosity
hypoid gear oil, API service
classified GL4 or GL5 only.

Power Steering Fluid:

Acura Power Steering Fluid preferred, or another brand of power steering fluid as a temporary replacement. Do not use ATF (see page [430](#)).

Brake Fluid:

Honda Heavy Duty Brake Fluid DOT 3 preferred, or a DOT 3 or DOT 4 brake fluid as a temporary replacement (see page [429](#)).

Tire Pressure (measured cold):

Front/Rear:

32 psi (220 kPa , 2.2 kgf/cm²)

Spare Tire Pressure:

60 psi (420 kPa , 4.2 kgf/cm²)

Owner's Identification

OWNER _____

ADDRESS _____

STREET

_____ CITY

STATE/PROVINCE/TERRITORY

ZIP CODE/
POSTAL CODE

V. I. N. _____

DELIVERY DATE _____

(Date sold to original retail purchaser)

DEALER NAME _____ DEALER NO. _____

ADDRESS _____

STREET

_____ CITY

STATE/PROVINCE/TERRITORY

ZIP CODE/
POSTAL CODE

OWNER'S SIGNATURE _____

DEALER'S SIGNATURE _____

This owner's manual should be considered a permanent part of the vehicle and should remain with the vehicle when it is sold.

This owner's manual covers all models of the Acura RDX. You may find descriptions of equipment and features that are not on your particular vehicle.

The information and specifications included in this publication were in effect at the time of approval for printing. Honda Motor Co., Ltd. reserves the right, however, to discontinue or change specifications or design at any time without notice and without incurring any obligation whatsoever.

**POUR CLIENTS CANADIEN
AVIS IMPORTANT: Si vous avez
besoin d'un Manuel du Conducteur
en français, veuillez demander à
votre concessionnaire de
commander le numéro de pièce
33STKC30**