



Lubricant		Capacity		Classification	
Engine oil	Diesel	D29ST	7.5 ~ 9.5 L	Quality class**	MB sheet : 229.1/3 (preferable) (API : CG grade or above ACEA : B2, B3 or B4)
				Viscosity	MB sheet No. 224.1
	Gasoline	G23D	6.0 ~ 7.5 L	Quality class**	MB sheet : 229.1/3 (API : SJ grade or above ACEA : A2 or A3)
		G32D	6.7 ~ 8.2 L	Viscosity	MB sheet No. 224.1
Engine coolant (Coolant/Distilled water Mixture)		D29ST	10.5 L	MB sheet 325.0, BASF GLYSANTIN G05-11, HOECHST GENANTIN SUPER 8023/14	
		G23D	10.5 L		
		G32D	11.3 L		
Manual transmission oil		4WD :3.6 L, 2WD : 3.4 L		ATF DEXRON® II	
Brake/Clutch fluid (Level must be maintained between MAX & MIN level)		Brake fluid : approx. 0.7 L		SAE J 1703, DOT 3 or DOT 4	
		Clutch fluid : approx. 0.3 L			
Power steering fluid		1.0 L		ATF DEXRON® II, III / Total fluid ATX	
Automatic transmission fluid (BTRA M74LE)*		9.5 L		CASTROL TQ 95	
Transfer case fluid		Part time: 1.2 L / TOD: 1.4 L		ATF DEXRON® III	
Front & Rear axle fluid	Front	Tong-IL: 1.0 L / Dymos: 1.2 L		SAE 80W/90, API GL-5	
	Rear	1.9 L			



FOREWORD

This manual has been prepared to acquaint you with the operation and maintenance of your new **KORANDO** and to provide important safety information. We urge you to read it carefully and follow the recommendations to help assure the most enjoyable, safe, and trouble-free operation of your vehicle.

When it comes to service, remember that your **SSANGYONG** dealer knows your vehicle best and is interested in your complete satisfaction.

We would like to take this opportunity to thank you for choosing **KORANDO** and assure you of our continuing interest in your motoring pleasure and satisfaction.

This manual should be considered as a permanent part of your vehicle, and must remain with the vehicle at the time of resale.

 **SsangYong Motor CO., LTD.**
PYUNGTAEK, KOREA



IMPORTANT NOTICE

Please read this manual and follow the instructions carefully.

 : This is the safety alert symbol used to alert you to potential hazards including injuries or damage to your vehicle or other property. Obey all safety messages that follow this symbol.

Throughout this manual, you will find special notations:

- Warning
- Caution
- Note

WARNING

WARNING indicates a potentially hazardous situation which, if not avoided, could result in serious injury or death.

CAUTION

CAUTION indicates a potentially hazardous situation which, if not avoided, may result in minor or moderate injuries, or damage to your vehicle or other property.

NOTE

NOTE indicates information which will assist you with maintenance or other instructions concerning your vehicle.

*** : The asterisk in this manual signifies an item of equipment that is not included on all vehicles. Such items include engine options, model variations specific to one country, and optional equipment.**

All information, illustrations, and specifications in this manual are based on the latest product information available at the time of publication.

Ssangyong reserves the right to change specifications or designs at any time without notice and without incurring obligation.

This vehicle may not comply with the standards or regulations of other countries. Before attempting to register this vehicle in any other country, check all applicable regulations and make any necessary modifications.

This manual describes options and trim available at the time of publication. Some of the items covered may not apply to your vehicle. Contact your Ssangyong dealer for information on option and trim availability.

Non-Ssangyong Genuine parts and accessories have not been examined or approved by Ssangyong. We can not certify the suitability or safety of non-Ssangyong Genuine parts and accessories and are not liable for damage caused by their use.





TABLE OF CONTENTS

1. BEFORE DRIVING YOUR CAR	1-1
2. STARTING AND OPERATING	2-1
3. INSTRUMENTS AND CONTROLS	3-1
4. VENTILATION, HEATING AND AIR CONDITIONING	4-1
5. TURBO CHARGER SYSTEM	5-1
6. IN CASE OF EMERGENCY	6-1
7. SERVICE AND MAINTENANCE	7-1
8. VEHICLE CARE	8-1
9. SPECIFICATION AND SERVICE DATA.....	9-1
10. INDEX	10-1





1

BEFORE DRIVING YOUR CAR



1-2 BEFORE DRIVING YOUR CAR

RUNNING-IN PERIOD

There are no particular run-in rules for your new Korando. However, following a few simple precautions for the first few hundred kilometers can add to the good future performance, economy and long life of your Korando.

- Do not race the engine.
- While driving, keep your engine speed (RPM) below the red zone.
- Avoid full-throttle starts.
- Avoid high-speed stops, except in emergencies. This will allow the brakes to bed in properly.
- Drive at varying speeds, trying not to "strain" the engine.
- Refrain from towing a trailer or another vehicle.
- Avoid harsh operations such as abrupt start, sudden acceleration and prolonged high speed driving.

These operations not only have a detrimental effect on the engine but also cause excessive fuel and oil consumption, which could result in the malfunction of the engine components. Especially, avoid full-throttle acceleration in low gear.

BEFORE ENTERING THE CAR

- Ensure that windows, outside rear view mirrors and lights are clean, undamaged and unobstructed.
- Visually note inflation condition of tyres.
- Check that all lights, switches and controls work properly.
- Check the area behind the vehicle if you are about to reverse.
- Check under the vehicle for leaks.
- Check the engine oil level and other fluid/oil levels in engine compartment.

BEFORE DRIVING OFF

- Be sure you understand your car and its equipment and how to operate it safely.
- Adjust your seating position.
- Adjust inside and outside mirrors.
- Ensure that all occupants of the car have fastened their seat belts.
- Check the operation of the warning lights when the ignition key is turned to "ON" position.
- Check all gauges.
- Release the parking brake and ensure that the brake warning light goes out.

WARNING

Check to ensure that all light, signaling systems and warning indicators are in working order.

KEY

Two keys are provided which fit all key cylinders. Keep one of the two keys as a spare. The key number is stamped on the key number plate. For vehicle security keep the key number plate in a safe place, not in the vehicle. You should also record the key number in a safe place, not in the vehicle. This deters unauthorized persons from obtaining a duplicate key.

WARNING

- Do not leave the key with the vehicle.**
- Lock the vehicle.
 - Take the key with you.

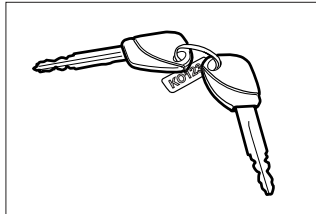
**KEY WITH INTEGRATED TRANSPONDER AND ILLUMINATION***

On vehicles equipped with an Immobilizer System, two keys with illumination and integrated transponder are provided. Keep one of the two keys as a spare.

The keys with illumination help you to insert the ignition key at night. To use it, press the light switch of key knob.

The key number is stamped on the key number plate. For vehicle security, keep the key number plate in a safe place, not in the vehicle. You should also record the key number in a safe place, not in the vehicle.

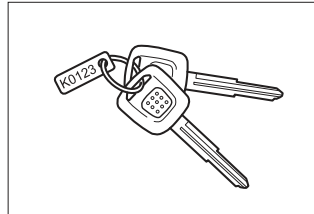

If you need additional keys, contact your Ssangyong Dealer.
See page 2-5 under Immobilizer System for further details.

WARNING

- Do not leave the key with the vehicle.**
- Lock the vehicle.
 - Take the key with you.

NOTE

In case of loss, replacement keys are available from Ssangyong Dealers by quoting the key number.
To protect your car from theft, an electronic immobilization system has been installed in your Korando. Only keys with correct electronic code can be used to start the car. Even if a key has the same profile, it will not start the engine if the electronic code is incorrect.
Always obtain replacement of additional keys from your Ssangyong Dealer.

1-4 BEFORE DRIVING YOUR CAR

KEYLESS ENTRY SYSTEM WITH ANTI-THEFT FUNCTION*

The keyless entry system lets you lock and unlock the doors from up to 15m away using the transmitter.

The LED on the transmitter flashes to show that it is operational.

A sophisticated electroic anti-theft alarm system is equipped to ensure maximum vehicle security. You are advised to gain a full understanding of the system by thoroughly reading this section of the manual.

NOTE

The operating range of the transmitter will vary due to environmental conditions.

- LOCK button : Locks all doors. Hazard lamps will flash twice, single beep will sound and the anti-theft system will be activated.
- UNLOCK button : Unlocks all doors. Hazard lamps will flash once and the anti-theft system will be deactivated.

Door Lock and Anti-Theft Mode

Activation

1. Close all windows.
2. Turn the ignition key to LOCK and remove the key.
3. Have all passengers exit the vehicle.
4. Close all doors, hood and tailgate.
5. Press and release the door lock button on the transmitter.
 - The LED on the transmitter will flash once.
 - All doors lock.
 - Single beep will sound.
 - Hazard warning lamps flash twice.
 - Anti-theft mode is activated.

If the ignition switch is in the ON position, the transmitter will not operate and the anti-theft system cannot be armed.

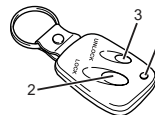

1. LED
2. Door lock button
3. Door unlock button

NOTE

The system can be activated even if the windows are open. Close all the windows and doors before leaving the vehicle.

NOTE

You must use the transmitter to activate the anti-theft mode.

When Arming the System

The system provides a visual and an audio alarm, if any of the doors, the tailgate or the hood are unlocked without using the key or pressing the unlock button on the transmitter after closing the door for more than 2 seconds.

After 27 seconds, the alarm will automatically stop.

Stopping the Alarm

the alarm stops only by unlocking a door or the tailgate with the key or by pressing the lock/unlock button on the transmitter.

If the system does not operate as described above, have it checked by your Ssangyong dealer.

Door Unlock and Anti-theft Mode**Deactivation**

1. Unlock the driver's door with a key, and anti-theft mode is deactivated.
2. Press and release the door unlock button on the transmitter.
 - The LED on the transmitter will flash once.
 - All doors unlock.
 - Hazard warning lamps flash once.
 - Anti-theft mode is deactivated.
3. Turn on the ignition switch with a key, and anti-theft mode is deactivated.

Auto Door Lock

If the door is not opened or the engine is not started within 30 seconds after disarming the system with the transmitter, all the doors are automatically locked and the theft deterrent mode is switched on.

NOTE

Theft deterrent system readiness will be released by positioning the tailgate to UNLOCK with the key when the alarm is activated.

However, under this conditions, theft deterrent system will be the secondary readiness and it will alarm again when the alarming conditions are established.

When you closed the tailgate completely again and after 2 seconds, theft deterrent system will be ready until you release it.

KEYLESS ENTRY TRANSMITTER**Matching Transmitter(s) to Your Vehicle**

Every transmitter is electronically coded to prevent another transmitter from unlocking your vehicle.

If a transmitter is lost or stolen, a replacement can be purchased through your Ssangyong dealer.

If you need a new transmitter, bring the remaining transmitter with you when you go to your Ssangyong dealer. When the dealer matches the replacement transmitter to your vehicle, the remaining transmitter must also be matched to the new code.

Once the new transmitter is electronically coded, the lost transmitter will not unlock your vehicle.

Up to 2 transmitters can be matched to your vehicle.

Battery Replacement

If the LED fails to illuminate, the transmitter can still be used for a while. However, it is an indication that a new battery is needed.

Use CR2032 (or equivalent) replacement battery

1. Open the screw from the rear cover.
2. Remove the battery, taking care to avoid touching the circuit board or other components.
3. Install the new battery.
Be sure the positive side (+) faces down toward the base.

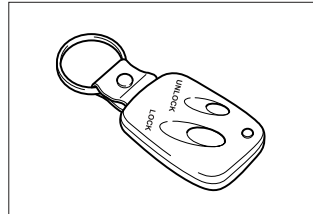



BEFORE DRIVING YOUR CAR 1-7

4. Reassemble the cover of the transmitter.
5. Check the transmitter operation.

CAUTION

Avoid touching the flat surfaces of the battery with your bare fingers. Handling will shorten battery life.

CAUTION

Transmitter can be damaged.

- Do not reverse the polarity.
- Avoid dropping.
- Do not place heavy objects on it.
- Keep transmitter away from water and direct sun light.

NOTE

- If transmitter gets wet, wipe it with soft cloth.
- When pressing the "Unlock" button while the room lamp switch is at "Door" position, the front room lamp comes on and goes out after 30 seconds.

DOOR LOCKS

Front doors can be locked or unlocked from outside by using the key. To lock, turn the key towards the front of the vehicle. To unlock, turn the key towards the rear of the vehicle.

CAUTION

Lock all doors and tailgate when leaving the vehicle unattended.

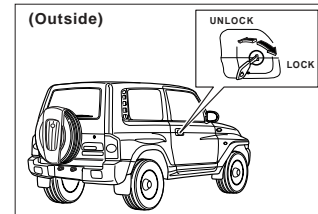
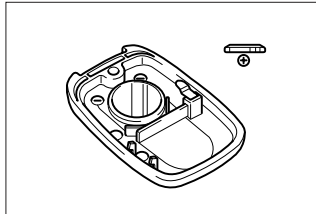

1-8 BEFORE DRIVING YOUR CAR

Each doors can be locked or unlocked from the inside by pushing or pulling the door lock button located in the inside door catch.

Each doors can be locked from the outside by pushing the door lock button then closing the door.

To open the door from the outside, turn the key and pull the door handle upward.

To open the door from the inside, pull the door lock button and pull the inside door handle.

⚠ WARNING

Never leave children or animals unattended in the vehicle.

- *They can move the vehicle unexpectedly.*
- *They can be suffocated in especially hot weather.*

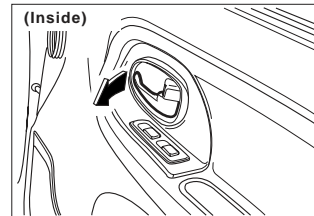
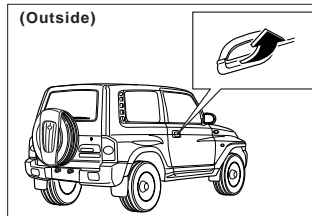
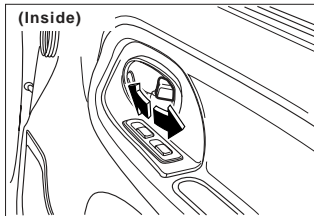

CENTRAL DOOR LOCKING SYSTEM

You can activate the central door locking system from driver's or passenger's door.

This system allows you to lock and unlock all the doors from the driver's or passenger's door, using either the key or keyless remote (from outside) or the door lock button (from inside).

AUTOMATIC DOOR LOCKING SYSTEM

Automatic door locking
All the doors will be automatically locked when you drive over 50km/h.

Automatic door unlocking
If you turn the ignition switch to 'OFF' all the doors will be unlocked automatically.

AUTOMATIC DOOR LOCKING RELEASE

If the vehicle velocity is above 15km/h at the event of collision, all doors and tailgate are unlocked automatically.

CAUTION

Lock driver's or passenger's door when leaving the vehicle unattended.

CAUTION

Automatic door locking system may not functional when the door or/and body is deformed by collision.

TAILGATE LOCKS

Tailgate can be locked or unlocked from outside by using the key.
To open the tailgate, turn the key counter-clockwise and then pull the door lever upward.
To close the tailgate, close it and then turn the key clockwise.

WARNING

An open tailgate while vehicle is in motion could obscure rearward vision, resulting in an accident. Do not travel with the tailgate open.

WARNING

Exhaust gases are poisonous. Do not drive with the tailgate open to avoid exhaust gas in passenger compartment.

POWER WINDOWS

You may operate the power windows when the ignition switch is ON by using the power window switches on each door panel.

NOTE

Operating time lag

- The operation of power window can be continued for 30 seconds even after turning the ignition switch off.*
- If you open the door within this period of time, the power window is not operated at once.*

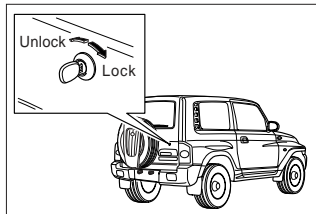

Operation Of Windows From The Driver's Seat

Driver's window

The driver's window has AUTO down.

- To lower the window, press down firmly, then release the switch. The window will open automatically until it is fully open. To stop the window while it is opening, press the switch again.
- To raise the window, pull up and hold the switch. To stop the window release the switch.

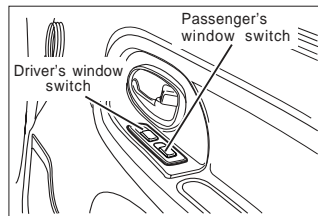

Passenger's window

To lower the window press down on the switch.

To raise the window lift up the switch. Release the switch when the window reaches the desired position.

NOTE

The operation of power window can be continued for 30 seconds even after turning the ignition switch off.

⚠ WARNING

Parts of the body can be trapped in power window and struck by passing objects.

- Keep a close watch on the windows when closing them.
- Do not stick hands, head or anything else out of the opening.

⚠ WARNING

Always remove the ignition key when leaving the car to avert the risk of injury arising from unattended children operating the windows.

Operation Of Windows From The Passenger's Seat

Passenger's switch is located on door to operate the corresponding door window.

To lower the window press down on the switch.

To raise the window lift up on the switch. Release the switch when the window reaches the desired position.

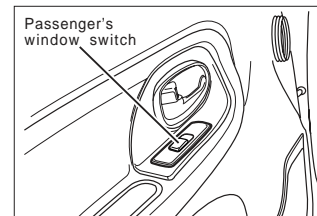

TILTABLE STEERING WHEEL

The steering wheel can be adjusted up or down to the desired position. To adjust the steering wheel, pull up the control lever, adjust the wheel up or down to the proper position, release the control lever to lock the wheel in place.

⚠ WARNING

**Control of vehicle can be lost.
Do not adjust steering wheel position
while vehicle is moving.**

POWER OUTSIDE REARVIEW MIRRORS

Adjust the outside rearview mirrors with the adjusting switches so that you can see not only each side of the road behind you but also each side of your vehicle. This helps you determine the location of objects seen in the mirror.

You may adjust the outside rearview mirrors up or down and left or right using the mirror switch located on the driver's door panel. The ignition switch must be ON to adjust the mirrors.

1. Select the mirror you want to adjust by using the left/right switch, located just below the mirror adjustment pad, to the left for left mirror or to the right for right mirror.
2. Adjust the selected mirror up, down, left, or right using the corresponding edges of the mirror adjustment pad.

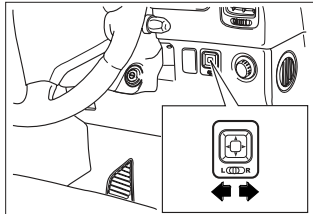
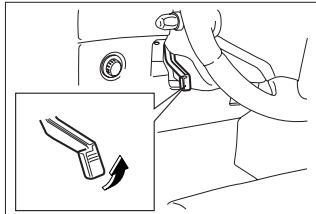



OUTSIDE REARVIEW MIRRORS

The outside rearview mirror on the passenger's side is convex if it says "OBJECTS IN MIRROR ARE CLOSER THAN THEY APPEAR". Use this mirror to get a wider view of the road behind.

⚠ WARNING

Side convex mirrors make objects appear smaller and farther away than when viewed in a flat mirror.

- Use the inside mirror to determine the size and distance of objects seen in the side mirror.
- Maintain rearward vision from driver's seating position.

⚠ CAUTION

Glass surface may be damaged. Do not scrape ice from mirror face.

⚠ CAUTION

Do not force mirror to adjust if ice should restrict movement of mirror. Use deicer, spray, or blower to remove ice.

⚠ CAUTION

Adjust mirror angles before driving.

Foldable Outside Rearview Mirrors

If necessary, the outside rearview mirror can be folded flat to the rear by pushing them rearward when driving on narrow roads or washing the vehicle, etc..

⚠ CAUTION

All round vision can be impaired, increasing potential for accidents.

- Adjust mirror angles before driving.
- Check glass surface for damage.
- Use deicer, spray or blower to remove ice.

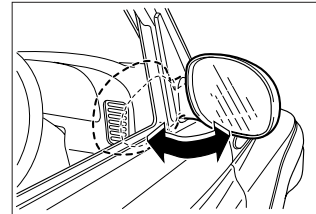

INSIDE REARVIEW MIRROR

The inside rearview mirror can be adjusted up, down or side ways to obtain the best view. The inside mirror has day and night positions.

Make adjustment while the adjusting lever is in the daytime position.

Move the adjusting lever to the night position to reduce glare from the headlights of vehicles behind you.

CAUTION

Maintain rearward vision from driver's seating position.

- **Select day position and adjust to obtain best view.**
- **Select night position to reduce night glare.**
- **Selecting night position may reduce rearward clarity.**

NOTE

Remember that you lose some rear-view clarity in the night position.

AUTOMATIC DIMMING INSIDE REARVIEW MIRROR*

At night, when the glare is too high, the mirror automatically responds to variations in light, changing from no antiglare to antiglare as required. The sensor under the mirror automatically detect the glare from headlights behind you and reduce the glare.

1. OFF : OFF (Ordinary usage)
2. AUTO : Automatic dimming operation at night

NOTE

Automatic dimming function will be operated when the ignition switch is turned "ON" or the engine is running.

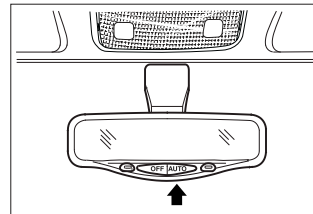
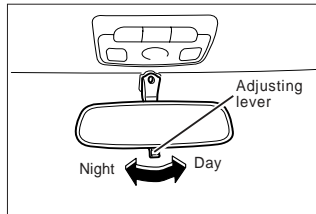



FRONT SEAT SLIDE ADJUSTMENT

To move the seat forward or backward, pull and hold the seat slide lever up and move the seat as required. Then, release the lever in desired position.

⚠ WARNING

*Control of vehicle can be lost.
Do not adjust driver's seat while vehicle is moving.*

⚠ WARNING

*Excessive seat belt slack could reduce effectiveness of seat belts.
Adjust front seat before fastening seat belt.*

⚠ WARNING

*Lose objects can interfere with seat-slide mechanism.
Do not place objects under seat.*

FRONT SEAT RECLINING ADJUSTMENT

To change the seat back angle, lean forward slightly and raise the lever. Then lean back to the desired angle and release the lever. After adjusting, make sure the lever is returned to its original position; otherwise, the seat back could unlatch while the vehicle is in motion, causing the driver to lose control of the vehicle.

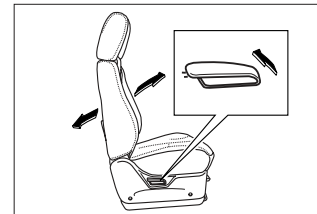
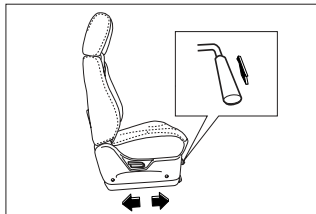

⚠ WARNING
*Control of vehicle can be lost.
Do not adjust seat back when vehicle
is moving.*

⚠ WARNING
Occupants can slide under seat belts.

- *Do not recline seat back too much.*
- *To get maximum protection, adjust seat back as upright as you can.*

DRIVER'S SEAT HEIGHT ADJUSTMENT*

To adjust the height of front seat, rotate the handle.
Release the handle to lock the seat in desired position.

DRIVER'S SEAT WARMER*

Warm the driver's seat in the cold weather for your comfortable driving.
Press the button to warm the seat, and press it again to stop the operation.

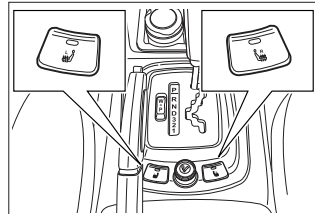
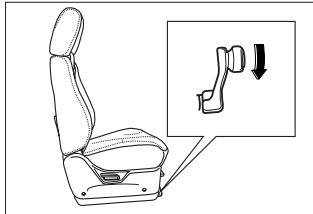



FRONT SEAT BACK STORAGE POCKET

The front seat back storage pocket is provided to store small items.

HEAD RESTRAINTS

Head restraints are designed to help reduce the risk of neck injuries. For maximum protection, slide the head restraint up or down so the top of the restraint is level with the top of your ears. To lower the front head restraint, press the release button on top of seatback and push it down. To raise the front head restraint, pull it up without pressing the release button.

To remove the head restraint

1. Pull it up to the stop position.
2. While pushing the release button
3. Lift the head restraint from the guide sleeve.

⚠ WARNING

Make sure that the head restraint are in place and adjusted before driving.

⚠ WARNING

Removed or improperly adjusted head restraints can result in serious head and neck injuries in case of a collision.

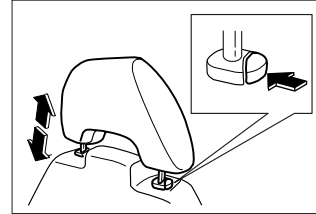
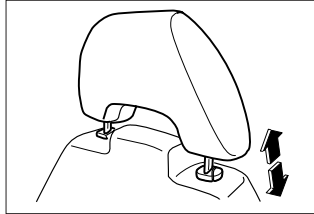
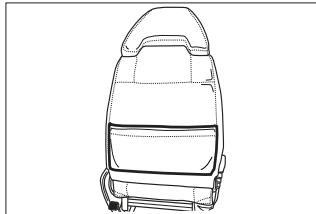

REAR SEAT ENTRY

The "only passenger's seat" has a lower lever to tilt the seat forward. To get into the rear seats, push the foot lever under the right bottom corner of the passenger's seat and tilt the seat forward. Then pull the seat back and check that it locks into proper position by sliding the seat. To get out of the rear seats, push the foot lever and tilt the seat forward.

RECLINING REAR SEAT BACK

The rear seat backs can be reclined separately for the comfortable driving of passengers.

Pull up the adjustment levers and recline the seat back to the desired position.

Then, release the adjustment lever to lock the seat back into position.

SIDE ARMREST

Pull or push the armrest to raise or lower it. To remove the armrest, lower the armrest and recline the rear seats rearward as the below figure. Then, pull armrest out while pushing the side button on the armrest.

To install the armrest, insert the bar on the armrest into the trim hole while pushing the side button.

⚠ WARNING

Occupants can slide under seat belts.

- **Do not recline seat back too much.**
- **To get maximum protection, adjust seat back as upright as you can.**

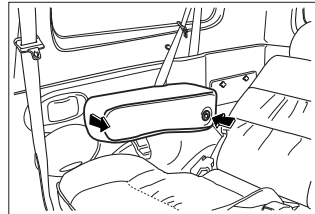
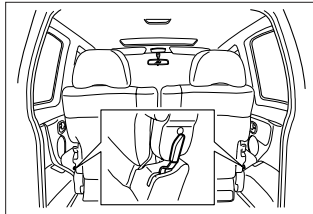
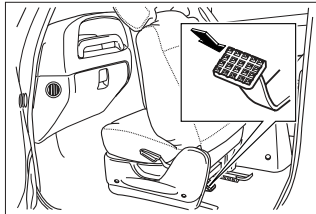



FOLDING REAR SEAT

To fold the rear seat to increase luggage space:

WARNING

To help avoid injuries, make sure your hand and any other body parts, as well as those of other persons, are completely away from the rear seat compartment when folding the rear seat.

1. Remove the side armrests.
2. Make sure seatback erect with pulling the lever ① forward.
3. Fold the seatback forward with pushing the lever ② forward.
4. Make sure the seat erect with pushing the lever ③ from the right to the left.
5. Pull the strap located at the bottom of the seat cushion across the seat.
6. Fit the attachment crook to the hook on the floor, rear of the console.

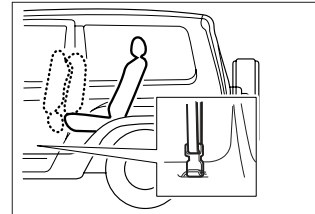
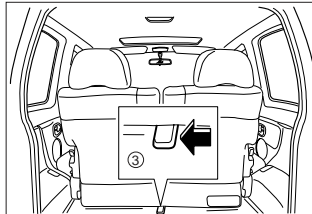
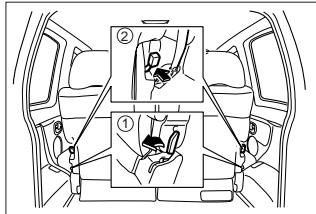

UNFOLDING REAR SEAT

To return the rear seat to its original position:

1. Unhook the crook of the strap from the hook at the rear of the console.
2. Secure the strap in its proper location.
3. Lower seat, allowing it to drop from height of about 8 inches (20cm).
4. Pull the seat upward to make sure the seat is securely latched.
5. Lift rear seatback and push to original position.
6. Latch the seatback into place by pushing on the top of the seatback.
7. Pull the seatback forward again to make sure the seatback is securely latched.

8. Make sure the seat belts are not twisted or caught in the seatback and are arranged in there proper position.

WARNING

To help avoid injuries, make sure your hand and any other body parts, as well as those of other persons, are completely away from the rear seat compartment when unfolding the rear seat.

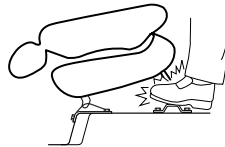

WARNING

Ensure that the rear seatbacks and rear seat cushion are locked in position before operating the vehicle with passengers in the back seat. Do not press the release buttons on the seatback while the vehicle is moving. Pressing the release buttons while the vehicle is moving can cause injuries or damage to the occupants.

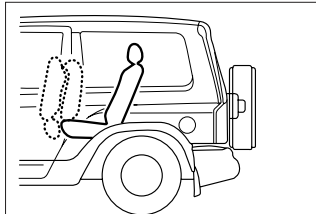

SEAT BELT PRECAUTIONS

To protect you and your passengers in the event of an accident, it is compulsory that the seat belts are worn by all occupants while the vehicle is in driving. Seat belts should be worn correctly.

Each seat belt is designed to be used by only one person at a time : they are not suitable for use by children below 6 years of age. Suitable child seats/booster cushions should be fitted.

WARNING

- *Do not stack luggage or other cargo higher than the front seats.*
- *Do not allow passengers to sit on the folded seatbacks while the vehicle is in motion.*
- *Unrestrained luggage or passengers on a folded seatback can be thrown about within or ejected from the vehicle in a sudden stop or accident.*
- *Serious injuries or death can result.*

WARNING

Occupants could be injured seriously in collisions or sudden maneuvers.

- *Wear seat belts at all times when driving or riding.*
- *Never use a belt for more than one person at a time.*
- *Do not wear seat belt over hard or breakable objects in pockets or on clothing.*

WARNING

- *Seatbelts are designed to bear upon the bony structure of the body, and should be worn low across the front of the pelvis or the pelvis, chest and shoulders, as applicable; wearing the lap section of the belt across the abdominal area must be avoided.*
- *Seatbelt should be adjusted as firmly as possible, consistent with comfort, to provide the protection for which they have been designed. A slack belt will greatly reduce the protection afforded to the wearer.*
- *Care should be taken to avoid contamination of the webbing with polishes, oils and chemicals, and particularly battery acid. Cleaning may safely be carried out using mild soap and water. The belt should be replaced if webbing becomes frayed, contaminated or damaged.*

⚠ WARNING

- *It is essential to replace the entire assembly after it has been worn in a severe impact even if damage to the assembly is not obvious.*
- *Belts should not be worn with straps twisted.*
- **EACH BELT ASSEMBLY MUST ONLY BE USED BY ONE OCCUPANT; it is dangerous to put a belt around a child being carried on the occupant's lap.**
- *No modifications or additions should be made by the user which will either prevent the seat belt adjusting devices from operating to remove slack, or prevent the seat belt assembly from being adjusted to remove slack.*

⚠ CAUTION

Improper use of seat belt can cause more serious injury.

- *Do not modify the seat belt.*
- *Do not add adjusting device which restrict removing slack.*

⚠ CAUTION

Damaged seat belt can cause more serious injury.

- *Repair or replace damaged seat belt immediately.*
- *Never let the seat belt system become damaged by a door or seat.*

When Using the Seat Belts

To help reduce the risk of personal injury in collisions or sudden maneuvers, use the seat belts following these instructions on their proper use maintenance, and use with child restraint systems.

⚠ WARNING

- Improperly worn seat belts could cause serious injury or death.*
- *Adjust the seat belt as firmly as possible.*
 - *Place the seat back upright position as you can.*
 - *Do not recline the seat back when vehicle is moving.*
 - *Never wear the seat belt with straps twisted.*
 - *Never wear the shoulder belt under your arm.*
 - *Shoulder belt should be positioned midway over the shoulder (never across neck).*
 - *Lap belt should be fitted snugly around the hips, not the waist.*

⚠ WARNING

High-positioned lap belts and loose fitting shoulder belts both could increase the chance of injury or death due to sliding under the lap belt during an accident.

⚠ CAUTION

Improper use of seat belt causes more serious injury.

- *Buckle release button should face outward.*
- *Insert seat belt buckle into proper buckle catch.*
- *Do not put anything into the opening where seat belt passes through the trim panel.*

NOTE

If the belt locks when being pulled out, rewind it completely in the retractor, then pull it out to the desired length.

Care of Seat Belts

Always keep the seat belts clean and dry. Care should be taken to avoid contamination of the webbing with polishes, oils and chemicals, and particularly battery acid.

Cleaning may safely be carried out using mild soap and water.

Do not bleach or dye belts since this may severely weaken them. Make sure that the belt is not damaged or trapped by sharp edged objects.

Periodically inspect all parts of the belts and have damaged parts replaced. A belt which has been overstretched in an accident must be replaced by a new one.

Ssangyong recommends replacing all component parts of the seat belts in use during a collision. No replacement is required after a minor collision if a Ssangyong Dealer or Ssangyong Authorized Service Operation finds that no damage has occurred and judges everything to be in proper working order.

Seat belts and components that were not in use during the collision must also be inspected and replaced if they show signs of damage or faulty operation.

⚠ CAUTION

Damaged seat belt can cause more serious injury.

- *Inspect seat belt assemblies periodically.*
- *Inspect seat belts and other constituent part after every collision.*
- *Replace seat belts if webbing become frayed, contaminated or damaged in any way.*
- *Replace the entire seat belt assembly after severe impact even if the damage is not obvious.*

⚠ CAUTION

*Improper seat belt could cause more serious injuries.
Do not modify seat belt.*

Pregnant Women

It is recommended that pregnant women use seat belts. Contact your doctor for specific recommendations.

⚠ WARNING

Pregnant women and unborn child could be injured.

- *Use a lap-shoulder seat belt if possible (Consult your doctor).*
- *Lap belt should be worn as low as possible throughout the pregnancy.*

CHILD RESTRAINT

When transporting infants or small children, an appropriate child restraint system should always be used.

The child restraint system should be appropriate for your child's weight and height and properly fit the car's seat.

Accident statistics indicate that children are safer when properly restrained in the rear seat rather than in the front seat.

⚠ WARNING

- ***Infants and small children should always be restrained in a infant or child restraint.***
- ***NEVER INSTALL A REAR-FACING CHILD RESTRAINT IN FRONT SEAT WITH FRONT PASSENGER AIR BAG.***
- ***A child in a rear-facing child restraint installed in the front seat can be seriously injured if the front passenger air bag inflates. Secure a rear-facing child restraint in the rear seat.***
- ***A front-facing child restraint should be secured in the rear seat whenever possible. If installed in the front passenger seat, adjust the seat as far back as it will go.***

⚠ WARNING

- ***When installing a child restraint system, follow the instructions provided by the manufacturer.***
 - ***When not in use, keep your child restraint system secured with a seat belt or remove it from the vehicle.***
 - ***Do not hold a child while riding in a vehicle.***
 - ***Never let a child stand or kneel on any seat.***
 - ***Do not allow a child in the cargo areas while the vehicle is moving.***
 - ***Children who have outgrown child restraint systems should sit in the rear seat and be restrained with the seat belt.***
- If child's seating position has a shoulder belt which is on or very close to the face or neck, move the child close to the center of the vehicle, slightly inboard of the shoulder belt, or move the child to a position without a shoulder belt if possible.***

WARNING

- *Child restraint anchorages are designed to withstand only those loads imposed by correctly fitted child restraints. Under no circumstances are they to be used for adult seatbelts, harnesses or for attaching other items or equipment to the vehicle.*

Australia Only**How to use child anchor**

1. Fold down the seatback.
2. Engage the attaching clip of child seat with child anchors on the wall.
3. Fold back the seatback to its original position, then tie-up the child seat with strap.

WARNING

- Unrestrained infants and small children could be injured.**
- *Never transport them unless they are properly restrained.*
 - *Use restraint system which meet safety standard.*
 - *Follow directions provided by the manufacturer.*

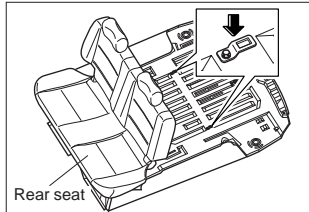
**Anchorage Locations**

Child restraint anchor fittings have been installed to coincide with the rear seating positions as follows.

NOTE

Use the child restraint anchorage for designed purpose only.

NOTE

- *Front seat (with Passenger Air Bag)*
"It is possible to the forward facing universal category child seat."
- *Front seat (with Passenger Air Bag)*
"It is possible install the forward and rearward facing univesal category child seat."
- *Rear seat (3 points s/belt)*
"It is possible to install the forward and rearward facing univesal category child seat."
- *Rear seat (2 points s/belt)*
"It is possible to install the forward facing universal category child seat."

Child Restraint Installation

Your vehicle has been designed to accommodate a child restraint on the rear seat. When using a child restraint, read the installation instructions supplied with the child restraint and follow the directions for fitment carefully.

When installing the child restraint, use the correct anchor bolt (5/16" bolt). The anchor bolt must be engaged at least 5 full threads in the anchorage.

The child restraint system should be secured in conjunction with the vehicle's seat belt. After installation, push and pull the child restraint to be sure it is secure.

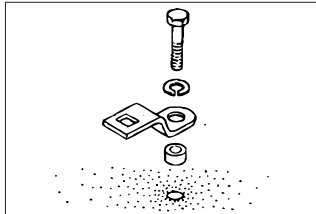

Secure the child in the restraint in accordance with the manufacturer's instructions. If you have any queries regarding the installation of a child restraint, consult a Ssangyong Dealer.

⚠ WARNING

Child restraint system placed in the front seat could cause more serious injury or death

- **NEVER INSTALL A REAR-FACING CHILD RESTRAINT IN FRONT SEAT WITH FRONT PASSENGER AIR BAG.** A child in a rear-facing child restraint installed in the front seat can be seriously injured if the front passenger air bag inflates. Secure a rear-facing child restraint in the rear seat.

A front-facing child restraint should be secured in the rear seat whenever possible. If installed in the front passenger seat, adjust the seat as far back as it will go.

⚠ WARNING

Loosely secured child restraint system can cause serious injury.

- *Tighten anchor bolt firmly.*
- *Anchor bolt must be engaged at least 5 full threads in the anchorage.*
- *Adjust restraint system as firmly as possible.*
- *Never use infant carrier or child safety seat that hooks over a seat back.*

⚠ CAUTION

Unused child restraint system could move forward. Remove child restraint system if not in use, or secure it with safety belt.

⚠ CAUTION

Exhaust gases could enter the vehicle interior. Cover the unused anchor holes with the supplied plug or suitable bolts.

NOTE

Since a safety belt or child restraint system can become very hot if it is left in a closed vehicle, be sure and check the seat cover and buckles before placing a child there.

Installation of the attaching clip

Positive engagement of the child restraint attaching clip is achieved by depressing the retainer spring and then opening of the anchor fitting as shown in the illustration.

Method of installation of anchor engagement

1. Child restraint anchor fitting
2. Attachment bolt
3. Lock washer

A 5/16"-UNC-2B-bolt with a thread length of 30 mm is used to attach the anchor fittings to the vehicle anchorage.

For fitting advice, please contact your authorized Ssangyong dealer.

WARNING

Child restraint anchorages are designed to withstand only those loads imposed by correctly fitted child restraints.

Under no circumstances are they to be used for adult seat belts or harnesses or for attaching other items or equipment to the vehicle.

Child restraint attaching clip

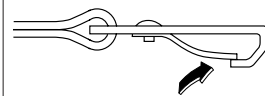

Example (in driving position)

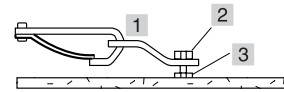

THREE POINT SEAT BELT

⚠ WARNING

- *When installing a child restraint system, follow the instructions provided by the manufacturer.*
 - *When not in use, keep your child restraint system secured with a seat belt or remove it from the vehicle.*
 - *Do not hold a child while riding in a vehicle.*
 - *Never let a child stand or kneel on any seat.*
 - *Do not allow a child in the cargo areas while the vehicle is moving.*
 - *Children who have outgrown child restraint systems should sit in the rear seat and be restrained with the seat belt.*
- If child's seating position has a shoulder belt which is on or very close to the face or neck, move the child close to the center of the vehicle, slightly inboard of the shoulder belt, or move the child to a position without a shoulder belt if possible.*

Each Ssangyong vehicle is equipped with three point seat belts with automatic retractors, allowing freedom of body movement when driving at even, constant speeds, although the spring-tensional belts are always fitted snugly.

The belt has a "vehicle sensitive retractor" which is designed to lock during heavy acceleration or deceleration.

Do not attempt to test the locking device by intentionally "shooting" your upper torso in the forward direction.

This type of belt requires no length adjustment. Once worn, the belt adjusts itself to the movement of wearer, but in the event of a sudden or strong shock, the belt automatically locks to restrain the wearer's body.

⚠ WARNING

"No modifications or additions should be made by the user which will either prevent the seat belt adjusting devices from operating to remove slack, or prevent the seat belt assembly from being adjusted to remove slack."

⚠ WARNING

- *Seatbelts are designed to bear upon the bony structure of the body, and should be worn low across the front of the pelvis or the pelvis, chest and shoulders, as applicable; wearing the lap section of the belt across the abdominal area must be avoided.*
- *Seatbelts should be adjusted as firmly as possible, consistent with comfort, to provide the protection for which they have been designed. A slack belt will greatly reduce the protection afforded to the wearer.*
- *Care should be taken to avoid contamination of the webbing with polishes, oils and chemicals, and particularly battery acid. Cleaning may safely be carried out using mild soap and water. The belt should be replaced if webbing becomes frayed, contaminated or damaged.*



WARNING

- *It is essential to replace the entire assembly after it has been worn in a severe impact even if damage to the assembly is not obvious.*
- *Belts should not be worn with straps twisted.*
- *Each belt assembly must only be used by one occupant; it is dangerous to put a belt around a child being carried on the occupant's lap.*

Using the Belt

Pull the belt evenly out of the retractor and guide it across the body, making certain that it is not twisted. Insert the metal latch plate into the buckle.

NOTE

If the belt locks when being pulled out, rewind it completely in the retractor, then pull it out to the desired length.

To remove the belt, depress the red push-button on the buckle. The belt will retract automatically.

WARNING

Improper use of seat belts could cause injuries.

- *Do not wear the shoulder portion of seat belt under the arm.*
- *Shoulder belt should be positioned midway over the shoulder, never across the neck.*
- *Lap belt should be fitted snugly around the hips, not the waist.*

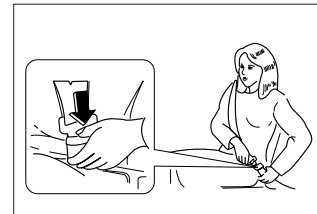
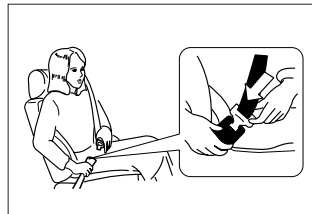

LAP BELT

A lap belt is installed in the center of the rear seat. Insert the metal latch plate into the buckle until it locks. To lengthen, hold the metal latch plate at right angles to the belt and pull on the belt. To shorten, pull the free end of the belt away from the metal latch plate, then pull the belt clip to take up the slack.

Position the lap belt low on the hips. To remove the belt, depress the red button on the buckle.

The buckle and metal latch plate of the center rear lap belt are identified by the "CENTRE" mark. Be sure to check the marking before wearing the center rear lap belt. The metal latch plate of the center rear lap belt can be fastened only into the buckle of center rear lap belt buckle.

CAUTION
 Damaged or incorrectly fastened seat belt could cause serious injury. Do not fasten the metal latch into incorrect buckle by force.

WARNING
 Improper use of seat belts could cause serious injury.

- Never wear the lap belt across your abdomen.
- Lap belt should be fitted snugly around the hips, not the waist.

NOTE
 When fastening the rear seat shoulder belt or the center rear lap belt, make sure the metal latch plate is inserted into the correct buckle to obtain maximum protection from the seat belt.

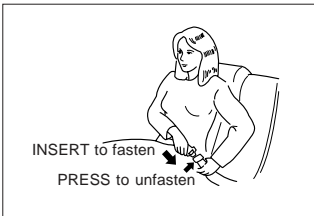
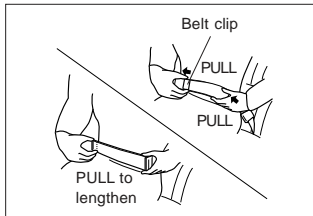
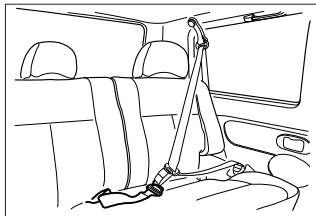

REAR THREE POINT SEAT BELT (CENTER)* - Mandatory where required by regulation.

1. Pull the Mini-latch plate (A) out of the seat belt console installed at the ceiling.
2. Pull the Mini-latch plate (A) across the shoulder and insert it into the buckle (3) until it clicks.
3. Pull the latch plate (B) out of the seat belt console installed at the ceiling.
4. Pull the latch plate (B) across the hips and insert it into the buckle (2) until it clicks.
5. To unfasten the seat belt, press the red (black) button on the buckle.

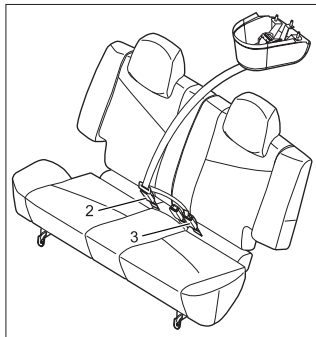

WARNING

- Make sure to fasten the seat belt according to the order as described so that it functions properly.
- To prevent the seat belt bumping against the rear glass, unfasten the seat belt while holding it.
- This seat belt is designed only for a passenger who sits on the center seat in the second row seat.

WARNING

- Tug on the seat belt to make sure the latch plate is securely locked.
- Make sure that the seat belt is not twisted.
- Improper wearing of seat belts increases the chance of injury or death in a crash.
 - Do not position the seat belt to pass across your neck and abdomen.

CAUTION

Stow the seat belt into the console when it is not in use.

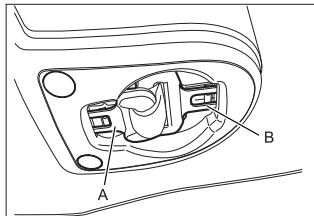

SEAT BELT PRETENSIONER*

The seat belts for the front seats are equipped with an automatic belt pretensioner.

The restraint system with belt pretensioner reduces the risk of injury in the event of a head on collision.

These seat belt pretensioners are always activated in a severe head on collision so that the driver and front passenger are pressed firmly back into their seats.

The belt pretensioner is not triggered in the event of a rear, side, rollover or a minor frontal collision.

**CAUTION**

Damaged seat belts can cause serious injury.

- *Inspect seat belts, pretensioners and other constituent parts after collision.*

CAUTION

Pretensioner will not function after activation.

- *In the event of a collision, ensure that pretensioners and all seatbelt components are checked by a Ssangyong Distributor or Ssangyong Authorized Service Operation, and replaced as necessary.*

SEAT BELT HEIGHT ADJUSTOR

The seat belt height adjustor is provided for the front seat.

Pull belt out, depress the side of the adjustor and adjust the height.

This is particularly important if a smaller person has previously selected a lower position. Too low or high a position can impair comfort.

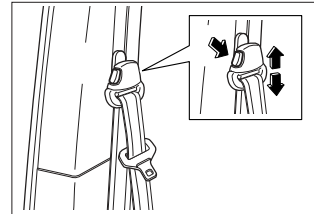



WARNING

Improperly worn seat belt could cause severe injury.

- *Adjust seat belt height before driving.*
- *Make sure the anchorage is locked in position.*
- *Shoulder belts should be positioned midway over the shoulder, never across the neck.*

CAUTION

Control of vehicle can be lost. Do not adjust the height of the driver's seat belt while driving.

AIR BAG*

The air bag Supplemental Restraint System (SRS) can provide additional protection for the driver against head and chest injuries in the event of a collision.

The air bag system activates during a severe collision which is either frontal or when the impact angle is up to 30° from straight ahead.

When the air bag inflates, an operating noise may be heard and a small amount of smoke like gas will be released. The gas is harmless and does not indicate that there is a fire.

Injuries, including fatal injuries, can occur in a severe collision, even if seat belts are worn properly and the air bags inflate.

No safety system can provide complete protection in a severe crash.

Just from viewing the vehicle damage after a crash, it is very difficult to accurately determine if the air bags should or should not have inflated. In some cases, where the air bag did not inflate, extensive visible damage indicate that the car absorbed much of the crash energy, and the air bags were not needed. In other cases, a severe jolt, such as an impact to the under carriage, may not cause extensive body damage but cause the air bags to inflate.

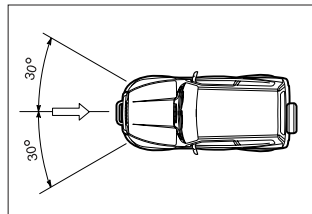

⚠ WARNING
Occupant could be injured.

- *Wear seat belt at all time.*
- *Air bag system serves as supplement to the seat belt.*

⚠ WARNING
Alternation of component could injure someone.

- *Do not modify original components.*

⚠ CAUTION
Treatment by unauthorized persons could be dangerous and cause injuries.

- *The air bag system must only be disposed by Ssangyong Dealer.*
- *The air bag system must only be replaced by a Ssangyong Dealer.*

⚠ CAUTION
Protection of occupants could be limited.

- *Do not stick anything on steering wheel and instrument panel.*
- *Do not cover steering wheel and instrument panel with other materials.*

⚠ CAUTION
Under the following conditions the air bag system will not be triggered.

- *Rear impacts*
- *Side impacts*
- *Rollovers*
- *Minor frontal collisions*

Driver's Air Bag*

The driver's air bag is stored in the center pad of the steering wheel. The air bag inflates within milliseconds during a crash and forms a safety cushion for the driver. After the air bag completely inflates, it immediately deflates so that it does not interfere with the driver's visibility or ability to steer and operate other controls. The air bag inflates with considerable force and speed. It is therefore important that the driver's seat and seat back should be correctly adjusted, for the air bag to be fully effective. The driver's seat should be adjusted so that the steering wheel can be reached with the arms slightly angled.

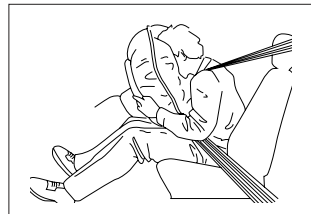

CAUTION

Treatment by unauthorized persons could cause injury. Repairs to steering wheel, steering column and air bag should only be done by a Ssangyong Dealer.

WARNING

The air bag is designed only for factory equipped vehicles. Modification will adversely affect system operation and performance and may cause personal injury.

Front Passenger's Air Bag*

On some models, an air bag is fitted on the front passenger's side.

The front passenger's air bag is stored above the glove box.

The system is of the same type as fitted for the driver.

This air bag is quite large and inflates with considerable force. It can seriously hurt a front seat passenger who is not in the proper position and not wearing the seat belt properly.

Front seat passenger should move the seat as far back as practical and sit well back in the seat.

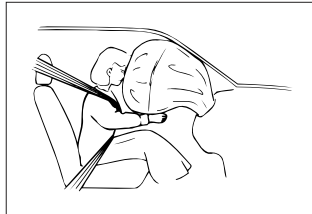
**WARNING**

Children could be injured seriously by air bag in collision.

- **NEVER INSTALL A REAR-FACING CHILD RESTRAINT IN THE FRONT SEAT.**

A rear-facing child restraint could be struck by the inflating front passenger air bag. Always secure a rear-facing child restraint in the rear seat.

- *A front-facing child restraint should be secured in the rear seat whenever possible. If installed in the front seat, adjust the seat as far back as it will go.*
- *Children who have outgrown child restraint systems should sit in rear seat and be restrained with seat belt.*

CAUTION

Treatment by unauthorized persons could cause injury. Repairs to instrument panel should be done by only Ssangyong Dealer.

FUEL FILLER DOOR RELEASE LEVER

The fuel filler is located in the rear quarter panel on the right-hand side of the vehicle. The fuel filler door release lever is located under the left side of driver's seat.

Filling Fuel Tank

1. Stop the engine.
2. Open the fuel filler door by pulling up the fuel filler door release lever.

3. Open the fuel filler cap by turning it counterclockwise.
4. After refueling, tighten the fuel filler cap by turning it clockwise and push the fuel filler door properly until it latches.

⚠ WARNING

Gasoline vapor is highly flammable. It burns violently and that can cause very bad injuries.
When refueling,

- Switch off engine.
- No smoking.
- No naked flame.
- No sparking material.

⚠ WARNING

Fuel may be under pressure.

- Unscrew fuel filler cap slowly.
- Wait for "hiss" noise to stop.
- Unscrew cap completely.

⚠ CAUTION

Engine and exhaust system will be damaged.
Make sure to use designated fuel to the vehicle.

⚠ CAUTION

Gasoline damages paintwork.
If gasoline spills onto paintwork wash with cold water immediately.

NOTE

The fuel filler door may not open in cold weather.
Push or tap fuel filler door lightly to open.

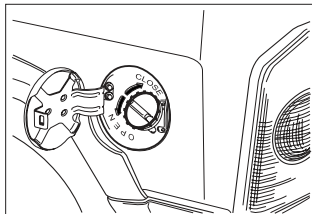
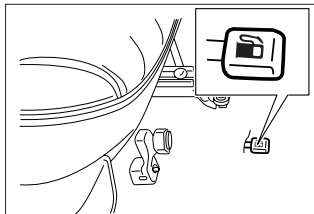

ENGINE HOOD

1. To open the engine hood, pull the release knob located on left lower side of instrument panel to unlatch the engine hood. The engine hood will then be unlocked and partially open.
2. Press the safety catch lever up located under the front edge of the hood and lift the hood fully. Two air-pressurized support rods will hold hood open.
3. To close the hood, lower the hood and push it down firmly until the lock is securely engaged.

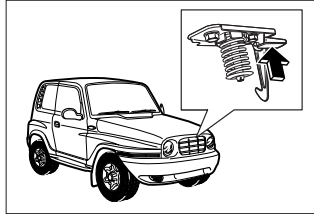
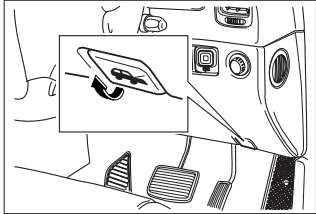

⚠ CAUTION
Be careful for popping the hood up by gas lifter for the reason of safety.

⚠ WARNING
An open engine hood with running engine exposes moving parts which car crush, cut or entangle.

- Do not wear loose clothing.
- Keep hands and hair away from moving parts.

⚠ WARNING
An open engine hood while the vehicle is in motion obscures forward vision, resulting in an accident.

- Check that the engine hood is fully latched in position by pulling at it's front edge before driving.
- Do not operate the engine hood release handle while vehicle is in motion.
- Do not move the vehicle with engine hood in raised position.

⚠ WARNING
The vehicle can still move from an stationary position while the engine hood is open.
Before releasing the engine hood latch;

- Remove ignition key.
- For manual transmission place gearshift in 1st or reverse.
- For automatic transmission place gearshift in P (Park).
- Apply parking brake fully.

⚠ WARNING
If it is necessary to check beneath the engine hood with engine running;

- For manual transmission place gearshift in neutral.
- For automatic transmission place gearshift in P (park).
- Set parking brake fully.
- Do not wear any clothing such as ties and handkerchiefs.
- Do not wear loose clothing.
- Keep hands and hair away from moving parts.



OPENING/CLOSING METHOD OF CANVAS ASSEMBLY

To open/close the canvas assembly, please keep the following procedure.

Opening Procedure

- To release the canvas assembly from the vehicle, push the both red buttons of latch lock.
- Zip the rear light open and then allow the rear light to hang down by pushing it inside the vehicle.
- Zip the left side light open.
- Remove the left side light by pulling it forward the vehicle.
- Zip the right side light open.
- Remove the right side light by pulling it forward the vehicle.

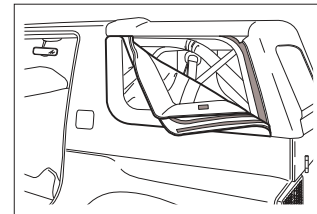
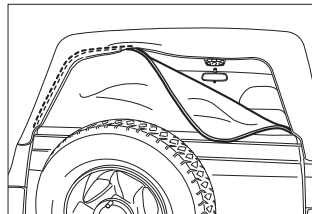
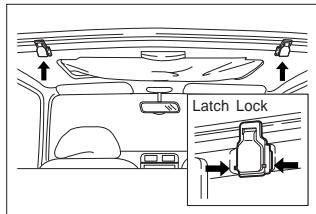



1-40 BEFORE DRIVING YOUR CAR

- Extract the fixing parts of the canvas assembly from the C-pillar molding hook.
- Hang down them inside the vehicle.
- To fold the canvas assembly, pull it backward the vehicle completely.
- Open the tailgate.
- Take the boot out of the boot-bag.

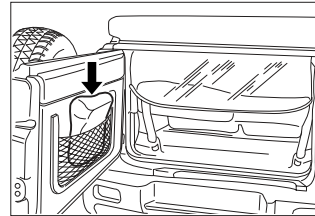
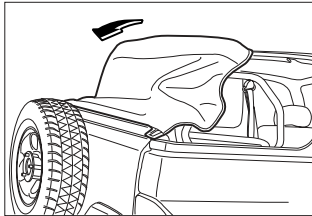
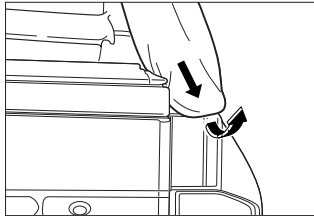



BEFORE DRIVING YOUR CAR 1-41

- After covering the canvas assembly with boot, latch the fixing device of the boot securely to the rounding parts of the C-pillar molding hook.
- Fix the both end parts of the boot by sticking the fasteners (Velcro patch).
- After making boot's straps go around the rear light, fix the boot's straps by adhered fasteners (Velcro patch).

NOTE

When install the boot, allow the straps of boot to be located inside the vehicle.

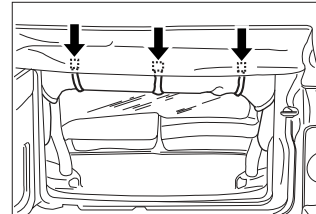
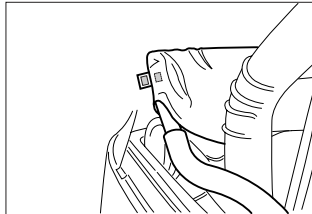
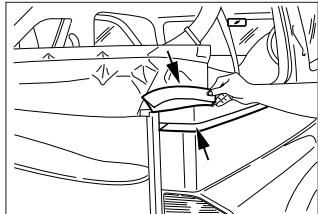

- After closing the tailgate, check the installation of boot.

WARNING

- **Never drive with an improperly installed boot.**
- **Injury and property damage could result.**

Closing (Covering) Procedure

Closing procedure is the reverse order of opening procedure.

However, to protect the leakage of water always observe the following precautions:

- When closing the canvas assembly, after securely latching the fixing parts of the canvas assembly to the C-pillar molding hook, latch the canvas assembly to the vehicle.

- When install the side lights, after securely latching the fixing device of the lower parts of the side lights, zip the side lights close, and then stick the fasteners (Velcro patch) of the side lights to the canvas assembly.

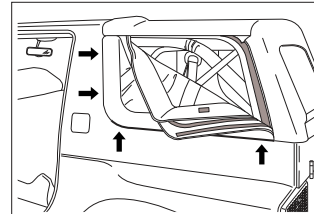
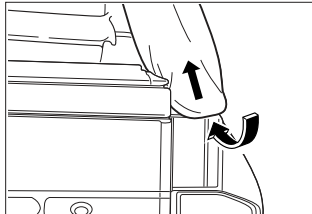
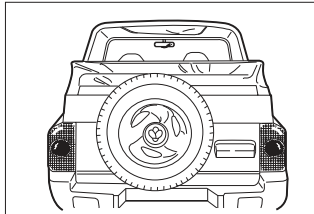



- And then stick the inside fasteners (Vetro patch) securely.

WARNING

**Never drive with an improperly installed canvas assembly.
Injury and property damage could result.**

NOTE

Precautions for vehicles with canvas assembly.

- **Do not leave valuables in vehicle. The canvas assembly does not have a locking device.**
- **In case of rain, do not park the vehicle outside for a long time. Avoid high-pressure car washes. These can cause water to enter your vehicle, damaging the interior.**
- **Opening and closing the canvas assembly are important for driving safety. Practise until to be good at the opening and closing of the canvas assembly with reference to this owner's manual.**

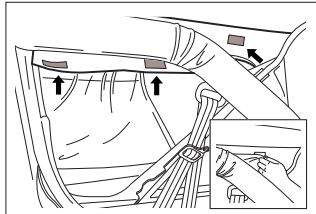

OPEN/CLOSE SUN ROOF

- To cancel the fixing condition of sun roof, pull downward the handle (1) of roof lock.
- Also, sun roof is opened when pushing upward sun roof.

WARNING

When tilting the sunroof, make sure to lock the sun roof securely by pushing the handle.

- To close the sun roof, pull downward the handle (2) by hand carefully.

CAUTION

Do not stick hands, head or anything else out of the opening sun roof.

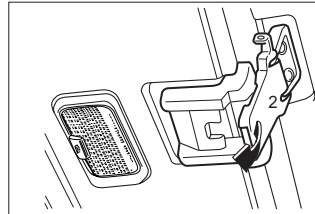
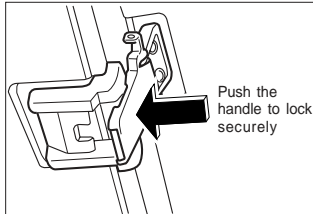
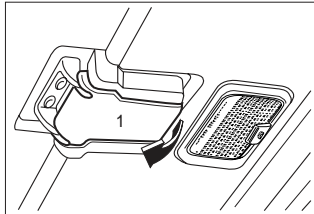

FIXING SUN ROOF

In case detach the sunroof from the vehicle by releasing the roof lock, make sure that sun roof is fixed securely by fixing device.

⚠ WARNING

*Do not store sun roof in passenger compartment.
In sudden stop or collision, loose equipment can be thrown around vehicle and personal injuries.*

Releasing the roof lock

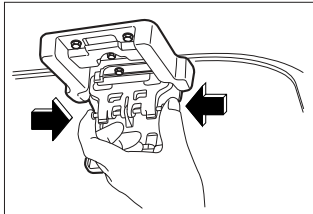

Placing sunroof on the support

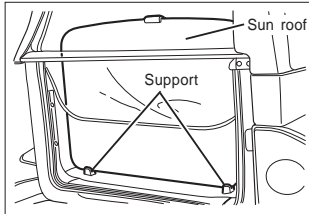

Fixing sun roof

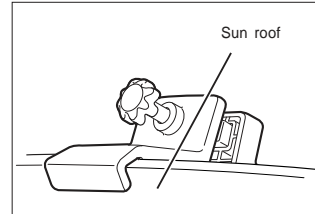



MEMO

Lined area for writing notes, consisting of 15 horizontal lines.





2

STARTING AND OPERATING



K140_RHD_EN_02.p65

1



2004-11-11, 4:08



FUEL RECOMMENDATION

Commercially available high-quality fuels are suitable. Fuel quality has a decisive influence on the power output, driveability and life of the engine. The additives contained in the fuel play an important role in this connection. You should therefore use only high-quality fuels.

Diesel Engine

Use diesel fuel at 50 cetane rating or higher.

Gasoline Engine

Fuel with too low an octane number can cause pre-ignition (detonation). Ssangyong can not be held liable for resultant damage.

CAUTION

For correct octane rating setting and other use of gasoline (ex. Leaded), consult your Ssangyong Dealer.

CAUTION

Engine and exhaust system will be damaged.

- *Do not use leaded fuel to the vehicle for unleaded fuel.*
 - *Use the fuel with specified or higher Research Octane Number recommended for your country by Ssangyong.*
- It is not covered by warranty.*

Do not Use Methanol

Fuels containing methanol (wood alcohol) should not be used in your Korando. This type of fuel can reduce vehicle performance and damage components of the fuel system.

NOTE

The warranty policy will not cover damage of the fuel system and any performance problems that are caused by the use of methanol or fuel containing methanol.

Operation in Foreign Countries

If you are going to drive your Korando in another country, be sure to :

- Observe all regulations regarding registration and insurance.
- Check that a suitable fuel is available.

Vehicle Fueling from Drums or Storage Containers

For safety reasons (particularly when using noncommercial fueling systems) fuel containers, pumps and hoses must be properly earthed.

Static electricity build up can occur under certain atmospheric and fuel flow conditions if unearthed hoses, particularly plastic, are fitted to the fuel dispensing pump.

It is therefore recommended that earthed pumps with integrally earthed hoses be used, and that storage containers be properly earthed during all noncommercial fueling operations.

IGNITION SWITCH

The ignition switch on the right side of the steering column has the following four positions, LOCK, ACC, ON, and START.

LOCK POSITION

The steering is locked by removing the key. Rotate the steering wheel until lock is engaged.

For easier key operation when unlocking, move the steering gently from right to left and turn the key to the "ACC" position.

NOTE

To turn the key from "ACC" to "LOCK" position, you must push it in.

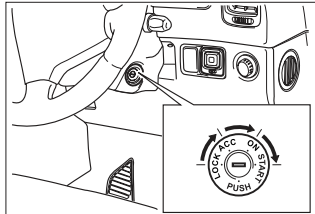

ACC POSITION

The engine can be turned off without locking the steering wheel.

Some electrical accessories such as the radio and cigarette lighter can be operated in this position.

CAUTION

Battery can discharge.
Do not leave key at "ACC" position for long.

ON POSITION

This position turns on the ignition system and the electrical accessories.

CAUTION

Battery will discharge.
Do not leave key at "ON" position without running the engine for long.

START POSITION

This position activates the starter motor, starting the engine.

Release the key when the engine starts, and it will be returned to the "ON" position automatically.

WARNING

Never remove or turn the key off while driving.

- **This can cause the driver to lose control of vehicle.**
- **This can result in serious vehicle damage or personal injury.**

WARNING

Steering wheel can suddenly turn.
Never reach for the ignition switch key through the steering wheel.

KEY REMINDER WARNING CHIME

The chime sounds to remind you to remove the key if the driver's door is opened with the key in the LOCK or ON position.

2-4 STARTING AND OPERATING

BEFORE STARTING THE ENGINE

- Make sure the area around the vehicle is clear.
- The maintenance items in this manual should be checked periodically, e.g., each time you check the engine oil.
- Check that all the windows and lights are clean.
- Visually inspect the tyres for their appearance and condition. Also check the tyre pressures for proper inflation.
- Position seat and adjust head restraints.
- Adjust inside and outside mirrors.
- Fasten your seat belts and ask all passengers to do likewise.
- Check the operation of the warning lights when the key is turned to the "ON" position.

STARTING THE ENGINE

1. Apply the parking brake.
2. **Manual Transmission :**
Move the gearshift lever to Neutral position and depress the clutch pedal to the floor while cranking the engine.

Automatic Transmission* :

Move the selector lever to "P" (Park) or "N" (Neutral), although "P" is preferred. The starter is designed not to operate if the selector lever is in one of the driving positions.

Diesel Engine Model :

The glow indicator light will come on and go out when the glow plugs are sufficiently heated for cold engine starting. As soon as the glow indicator light goes out, start the engine.

3. Crank the engine without touching the accelerator pedal by turning the igniting key to the "START" position. Release the key when the engine starts. If the engine starts, but fails to run, repeat the above procedure.

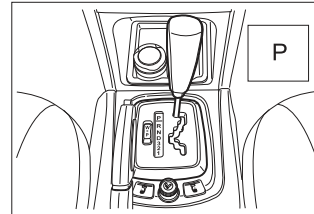
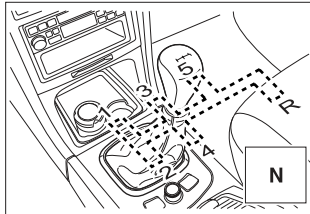

CAUTION

To prevent starter motor damage;

- **Do not operate the starter for more than 15 seconds at a time.**
- **If the engine does not start, wait 10 seconds before trying again.**

4. Warm-up
Allow the engine to idle for at least 30seconds after starting. Drive at moderate speed for a short distance first, especially in cold weather.

CAUTION

Excessive temperature can damage the exhaust system.
Do not idle at high speed for more than 5 minutes.

NOTE

On vehicles equipped with an automatic transmission, fuel is automatically cut off when the engine is "racing" (running at high speed) with selector lever position "P" or "N".

IMMOBILIZER SYSTEM*

The Immobilizer System provides an additional theft deterrence to the vehicle in which it is installed and prevents it from being started by unauthorized persons.

When the ignition key with integrated transponder is turned to the ON position, ECU (Engine Control Unit) checks the crypto code of key and, if correct, allows your Korando to start the engine.
If you can not start the engine, have the system check by Ssangyong Dealer.

The valid key for a vehicle equipped with a Immobilizer System is a mechanical ignition key with integrated transponder, which is electronically coded. The transponder is placed invisibly in the ignition key.

Only valid ignition keys can be used to start the engine.

The immobilizer system isolates fuel injection control system in ECU (electric control unit) when invalid keys are used.

DRIVING WITH A MANUAL TRANSMISSION

To change gears, fully depress the clutch pedal. Then move the gearshift lever. After shifting, release the clutch smoothly.

CAUTION

Shifting to reverse gear while vehicle is moving forward could damage the transmission.
Stop your vehicle completely before shifting into reverse.

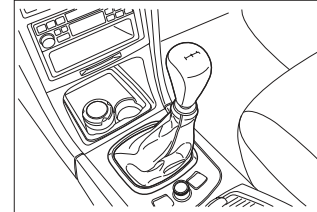

CAUTION
To prevent clutch damage, do not rest your foot on the clutch pedal while driving.

CAUTION
Never take the vehicle out of gear and coast down a hill.

DRIVING WITH AN AUTOMATIC TRANSMISSION*

The automatic transmission in your Korando has 4 forward speeds and 1 reverse speed. The position of the selector lever is indicated on the left side of the selector lever and instrument cluster.

WARNING
The vehicle could move unexpectedly when shifting. You could lose control and hit people or objects. Always depress brake pedal firmly while shifting from "P" (Park) or "N" (Neutral) to a forward or reverse gear.

CAUTION
Always use the parking brake. Do not depend on "P" position to keep the vehicle from moving.

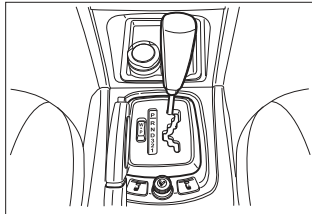

⚠ WARNING

To prevent transmission damage;

- Do not depress the accelerator pedal while shifting from "P" or "N" to "R", "D", "3", "2", or "1". Always depress the brake pedal until shifting is completed.
- Never shift to "P (Park)" or "R (Reverse)" while the vehicle is in motion. Shift to "P" or "R" only after vehicle is stopped completely.
- When stopping the vehicle on an uphill gradient, do not hold the vehicle by depressing the accelerator pedal. The foot brake should be used for this purpose.
- To drive on a slope, set the lever to "3", "2" or "1" position according to road condition.

Starting the Car

- After starting the engine, fully depress the foot brake pedal before shifting the selector lever to the "R", "D", "3", "2" or "1" position. Be sure the vehicle has completely stopped before attempting to shift the selector lever into "R" or "P".
1. Keep the foot brake pedal depressed and shift into a driving gear.
 2. Release the parking brake and foot brake. Depressing the accelerator pedal slowly will gradually set the vehicle in motion.

Selector Lever Positions P, R and N

P = Park, with the rear wheels locked. To be selected only with the stationary vehicle and the parking brake on.
 R = Reverse. To be engaged only with the stationary vehicle.
 N = Neutral.

⚠ WARNING

The vehicle can move suddenly when unattended.

- Turn off the engine, apply the parking brake fully and remove the ignition key when leaving the vehicle.
- Do not use "P" (Park) position in place of the parking brake.
- Never leave the vehicle unattended while the engine is running.

NOTE

Fuel is automatically cut off when the engine is "racing" (running at high speed) with selector lever position "P" or "N".



2-8 STARTING AND OPERATING

Drive Range "D"

D = The drive position for normal driving conditions in first to fourth gear.

Fourth gear (the overdrive gear) reduces engine speed, fuel consumption and the engine noise level.

After the engine has been started and "D" selected, the economy driving program is always operative.

Drive Range 3

3 = The drive position for driving conditions in first, second and third gear.

You might choose 3 instead of D under the following conditions:

- When driving on long hilly roads
- When driving in heavy city traffic
- When going down a steep hill

Drive Range 2

2 = The drive position prevents the transmission from shifting into third or fourth gear.

Select drive range 2 for more power when climbing hills, for engine braking effects when driving down steep hills.

Drive Range 1

1 = The drive position for maximum braking effect, e.g. when driving down severe gradients; the transmission does not shift beyond first gear.

MODE SWITCH**[W] - WINTER MODE**

Press the "W" portion of the mode switch to select "WINTER" driving mode and "WINTER" indicator lamp will be displayed on the instrument panel.

Use this mode in the event of starting-off or driving difficulties on slippery roads.

[P] - POWER MODE

For increased power, improved acceleration or driving up long slopes, press the "P" portion of the mode switch.

The "POWER" indicator lamp will be displayed on the instrument panel.

The transmission will shift into the power driving pattern. The transmission will shift at higher engine revolutions, allowing more powerful acceleration.

[N] - NORMAL

Use this mode for your normal driving. This driving mode can be selected when both "W" and "P" portions are not pressed.

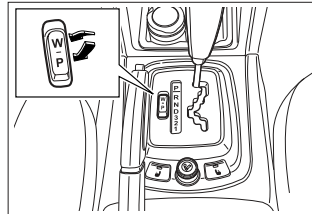

AUTOMATIC TRANSMISSION EMERGENCY SHIFTING PROCEDURE

Your vehicle has a shift lever lock control system. Before you can shift from park (P), the ignition must be ON and you must depress the brake pedal.

If you cannot shift out of P with the ignition ON and the brake pedal depressed:

1. Turn ignition off.
2. Pry off the cover.
3. Push the shift lock release lever by inserting a proper stick. Then, with the brake pedal depressed, move the selector lever to N (neutral).
4. Start engine and shift into the gear you want.

5. Have your vehicle repaired by Ssangyong dealer or authorized service operation as soon as possible.

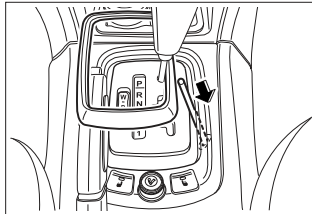

DRIVING TIPS FOR AUTOMATIC TRANSMISSION*

Starting the Car

After starting the engine and before shifting into a drive range, depress the brake pedal since the vehicle will otherwise start to "creep". Never use accelerator and brake pedals simultaneously.

For normal driving conditions the "D" should be selected.

If the accelerator pedal is depressed gently and evenly the transmission will shift into the fuel-saving higher gears at an early stage. The drive range needs to be changed manually only in exceptional cases. Select "3", "2" and "1" only when automatic shifting up is to be avoided or if additional use is to be made of the engine braking effect.

Return to "D" as soon as conditions permit.

Kickdown

If you need to accelerate rapidly, depress the accelerator pedal completely to the floor to push the kickdown switch on the floor. Then, the kickdown will be operated and the transmission shift to a lower gear automatically.

Engine Braking

In order to utilize the engine braking effect when driving downhill, select drive range "3", "2" or, if necessary, "1".

The braking action is most effective in drive range "1". If drive range "1" is selected at too high a speed, the transmission remains in second gear until the shift point for first gear is reached, e.g. as a result of deceleration.

Stopping the Car

The selector lever can be left in the chosen drive range with the engine running. When stopping on gradients engage the parking brake or depress the brake pedal. Do not increase the engine revolutions to ensure smooth idling while standing if a drive range has been selected.

Switch off engine if stopping for a lengthy period, e.g. in traffic jams or at level crossings.

Before leaving the vehicle, apply parking brake, then place selector lever in position "P" and remove ignition key.

Maneuvering the Car

To maneuver the car back and forth during attempts to park or in garage entrances utilize the creeping effect.

Regulate your speed by lightly releasing the brake pedal.

Never press the accelerator and brake pedals simultaneously.

NOTE

- **CREEP effect**

The vehicle will move slowly without acceleration when the engine is running if you select "R", "D", "3", "2", "1" positions and it is called "CREEP" effect. It is very unique characteristics in which weak power will be continuously delivered to the transmission in order to rotate torque converter in the automatic transmission system.

4-WHEEL DRIVE OPERATION

Driving Position

The 4WD indicator light illuminates when the 4WD switch is in '4H or 4L (Part-time)' or '4L (TOD)' position.

Part-time	2H	4H	4L
TOD	-	4H	4L

- **'2H' (2-Wheel drive)**
(Part-time only)
Use this for normal driving. This position gives greater economy, quieter ride and least drive train wear.

- **'4H' (4-Wheel drive, high)**
- 1. **Part-time** : Use this for driving on wet or slippery roads such as roads with snow, mud or sand. This position provides greater traction than 2-wheel drive. The front hubs will be locked automatically.
- 2. **TOD** : Use this for normal driving.

- **'4L' (4-Wheel drive, low)**
Use this for maximum power and traction. Use '4L' for climbing or descending steep hills, hard pulling in sand, mud or deep snow.

4-Wheel Drive Operation

- **'2H' ↔ '4H' (Part-time only)**
Depending on the road conditions, rotate the transfer switch to '4H' before driving off or during driving. Shifting is possible while driving at the speed of 70km/h or less. The 4WD high ('4H') indicator light may come on. When 4WD is no longer needed, rotate the 4WD switch from '4H' to '2H'. This will avoid unnecessary heavy steering, tyre wear and fuel consumption.

NOTE
Perform this operation when driving straight.

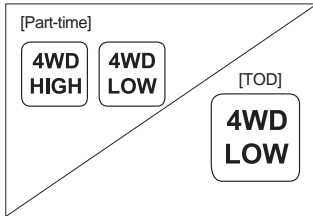
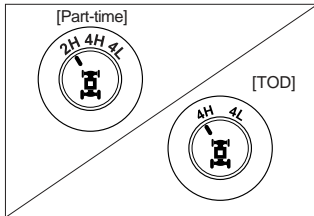

- **'4H' ↔ '4L' (common)**

To shift from '4H' to '4L', the vehicle should be stopped.

Depressing the clutch pedal (with manual transmission) or moving the selector lever to 'N' position (with automatic transmission), rotate the 4WD switch to '4L'. The 4WD low ('4L') indicator light may come on.

When '4L' operation is no longer needed, rotate the transfer switch from '4L' to '4H'. To shift from '4L' to '4H', stop the vehicle and depress the clutch pedal (on manual transmission) or move the selector lever to 'N' position (on automatic transmission) and rotate the 4WD switch to '4H'.

- **'2H' ↔ '4L'**

Follow the '2H' ↔ '4H' ↔ '4L' operation.

⚠ WARNING

In case of part-time 4WD, do not use 4WD for normal driving on dry pavement. It will cause unnecessary noise, wear and fuel economy.

⚠ WARNING

To shift '4L' or '4H' position, completely stop the vehicle and always depress the clutch pedal, for manual transmission, or position the selector lever to "N", for automatic transmission, and turn the 4WD switch to '4L' or '4H'.

NOTE

When shifting '4L' → '4H' in automatic transmission, foot brake and shift the selector lever to "N → R → N" after 4WD LOW indicator OFF for smooth shifting.

T.O.D (TORQUE ON DEMAND)*

Full time vehicle is equipped with T.O.D system.

T.O.D provides the suitable power to front & rear axle based on sensing data by transfer case control unit, e.g. propeller shaft speed, operating range of 4H & 4L and operating of brake/ABS.

T.O.D will help your vehicle to remain steerable, stable around the corner especially.

2-14 STARTING AND OPERATING

OPERATION TIP

Vehicle	D29ST, G23D				G32D	
Model	Part-time				TOD	
T/M	Manual T/M		Automatic T/M		Manual T/M	Automatic T/M
4WD	2H ↔ 4H	2H,4H ↔ 4L	2H ↔ 4H	2H,4H ↔ 4L	4H ↔ 4L	
Shifting condition	Below 70km/h	Stop	Below 70km/h	Stop	Stop	
Clutch	-	Depressed	-	-	Depressed	-
Shifting mode	-	-	-	Neutral "N"	-	Neutral "N"

BRAKE

Your vehicle is equipped with disc brakes at all 4 wheels.

- If one brake circuit should fail, the vehicle can still be stopped with the second remaining circuit. If this happens, the brake pedal must be fully depressed with greater pedal pressure. The braking distance is increased. Have the braking system checked and repaired by a Ssangyong Dealer or Ssangyong Authorized Service Operation before continuing your journey.
- After being parked, check to be sure the parking brake is not engaged and that the parking brake indicator light is out before driving away.
- Do not coast down hills with the vehicle out of gear. This may be extremely hazardous. Keep the vehicle in gear at all times, use the brakes to slow down.
- If a tyre goes flat while driving, apply the brakes gently and keep the vehicle pointed straight ahead while you slow down. When you are moving slowly enough for it to be safe to do so, pull off the road and stop in a safe place.

⚠ WARNING

Brakes can have temporary loss of performance due to overheating.

- *On descents shift to a low gear.*
- *Do not continually apply brakes.*

⚠ WARNING

Do not drive with your foot resting on the brake pedal. This could result in the brakes overheating and losing their effectiveness, wear out the brake pads.

⚠ WARNING

Brakes can have temporary loss of performance due to wet brake components.

- *After checking the rear for other vehicles, lightly apply brakes for performance loss.*
- *Keep safe forward speed.*
- *Keep plenty of space ahead, to the rear and to the sides.*
- *Lightly apply brakes until performance is normal.*
- *Always apply this procedure after driving through water deep enough to wet brake components or having the vehicle washed, to help reduce the risk of personal injury.*

ANTI-LOCK BRAKE SYSTEM* (ABS)

Anti-lock brake system is an advanced electronic braking system that will help prevent a braking skid.

The anti-lock brake system prevents the wheels from locking up during sudden braking or braking on a slippery road to help the vehicle remain steerable and stable.

This system becomes operative only when it senses differences in rotational speed of the wheels, and that they are about to lock up. The system detects the wheel speed and electronically controls the pressure applied to the brake.

When the ignition is switched on, the ABS warning light comes on. It goes out after about 2 seconds. If it does not go out, or if it comes on during driving, there is a defect in the ABS. In this case the brake system performs its regular function but without the anti-locking capability.

In the event of a defect in ABS, the traction control system (TCS) is shut off as well. Have the ABS checked by Ssangyong Dealer or Ssangyong Authorized Service Operation as soon as possible.

CAUTION

Driving too fast, particularly in corners, aquaplaning and driving too close to the vehicle in front increases the risk of an accident. This risk can not be reduced by the ABS system.

Braking with ABS

Don't pump the brakes. Press the brake pedal hard down regardless of the road surface (dry, wet, slippery, etc.), hold it down and let ABS work for you.

The ABS modulates the braking pressure to the respective wheels to maintain the maximum braking effect on the vehicle, reducing the loss of directional stability or steering control.

Slight vibration accompanied by noise usually occurs while ABS is operating. Such vibration and noise simply indicates that the ABS is functioning normally.

In an emergency, apply full force on the brake and clutch pedal simultaneously.

The anti-lock brake system will be activated immediately, thus allowing you to retain full steering control of your vehicle.

We recommend that you familiarize yourself with this braking technique. However, avoid taking unnecessary risks.

WARNING

Stopping distances can vary greatly depending on the road surface and conditions.

- *Maintain safe distance to the vehicle in front.*
- *Drive slowly on wet or slippery road.*

WARNING

ABS cannot prevent accidents resulting from careless or dangerous driving techniques.

- *Drive carefully.*
- *Slow down when cornering.*
- *Press brake pedal hard and hold.*

WARNING

Brake system and ABS warning light illuminating at the same time indicates a failure in the base brake system due to malfunction of ABS.

- *Stop the vehicle and consult your Ssangyong Dealer.*
- *Have the system checked and repaired before continuing your journey.*

TRACTION CONTROL SYSTEM* (WITH ANTI-LOCK BRAKE SYSTEM)

The traction control system (TCS) is an advanced system that will help you to move off on slippery surfaces.

If one of the wheels is on firm ground and the other is on slippery ground such as snow or mud.

If you then start to drive off, the wheel on the slippery surface will spin and the car will not move.

TCS can help you to prevent this by locking and releasing the wheel on the slippery surface.

When the ignition is switched on the TCS warning light comes on with the ABS warning light.

It goes out after around 2 seconds. The TCS warning light flashes when traction control function is operating.

A fault with the TCS system will illuminate the TCS warning light while the engine is running.

If this condition occurs, consult your Ssangyong Dealer as soon as possible.

WARNING

Excessive speeds increase the risk of accidents. The TCS system can neither eliminate nor reduce any such risk.

NOTE

During driving, the TCS indicator light flashes on only when the TCS is operating.

NOTE

In the event of a defect of the anti-lock braking system (ABS), the TCS is shut off as well.

PARKING BRAKE

The parking brake acts on the rear wheels. It engages automatically when applied. The parking brake lever is located between the front seats.

To apply the parking brake, depress the brake pedal and pull the lever up fully.

To release, depress the brake pedal, pull the lever up slightly and push the button in the tip of the lever. Then lower the lever while holding the button in.

Ensure the parking brake is fully released before driving off.

See your Ssangyong Dealer if adjustment of the parking brake is required.

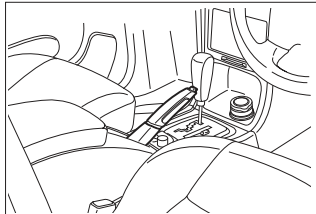

When Parking Your Vehicle

1. Hold the brake pedal down and firmly apply the parking brake.

2. **Manual transmission models :**

When parking on level ground, place the gearshift lever in the "NEUTRAL" position.

When parking on a downhill gradient, place the gearshift lever in the "REVERSE" position.

When parking on an uphill gradient, place the gearshift lever in the "1st" position.

Automatic transmission models :

Move the selector lever to the "P" (PARK) position.

3. Close all windows and sun roof*.
4. Turn the ignition key to the "LOCK" position and remove the key.
5. Lock all doors and tailgate.
6. Be sure the vehicle is not moving.

CAUTION

Things that can burn could touch hot exhaust parts under your vehicle and ignite.

Do not park or operate vehicle over combustible materials.

CAUTION

The vehicle can move when parked.

- *Always apply parking brake fully.*
- *Park on firm, level ground.*
- *When hill parking, do not leave front wheels in straight ahead position.*

CAUTION

Driving with parking brake applied could damage rear brake system.

- *Before driving, fully release parking brake.*
- *Check brake system warning light off.*

CAUTION

Under cold weather conditions, the parking brake can freeze in the engaged position.

This is most likely to happen if the brakes are wet.

If there is a risk that parking brake may freeze after driving through water deep enough to wet brake components or having the vehicle washed;

- *Apply the parking brake only temporarily while you put the gear selector lever in "P" (automatic transmission) or in first or reverse gear (manual transmission).*
- *Block the rear wheels so that the vehicle cannot move.*
- *Then release the parking brake.*

Parking brake warning light and buzzer

If the vehicle is driven for over 2 seconds (over 10 km/h) while the parking brake is applied, the parking brake warning light in meter cluster comes on and warning buzzer sounds. If it occurs, immediately stop the vehicle and release the parking brake.

SUGGESTIONS FOR MORE ECONOMICAL OPERATION

Your car's fuel economy is mainly dependent on your style of driving.

How you drive, where you drive, and when you drive has an effect on how many kilometers you can get from a litre of fuel.

To obtain maximum fuel economy from your car:

- Start gradually and accelerate gently.
- Avoid excessive and unnecessary idling.
- Keep your engine properly tuned.
- Do not race the engine.
- Use the air conditioning (if equipped) only when necessary.
- Slow down when driving on rough roads.
- Always keep your tyres inflated to the recommended pressure for longer tyre life and optimum fuel economy.

ENGINE EXHAUST GAS**CAUTION (CARBON MONOXIDE)**

- Keep your distance from other vehicles to avoid sudden stops. This will reduce wear on brake linings and improve economy as extra fuel is required to accelerate back up to driving speed.
- Do not carry unnecessary weight in the vehicle.
- Do not rest your foot on the brake pedal while driving. This can cause needless wear, possible damage to the brakes and poor fuel economy.
- Always ensure your vehicle is maintained to the manufacturer's specification.
- Avoid inhaling engine exhaust gases. Engine exhaust gases contains carbon monoxide, which has no colour or odor. Carbon monoxide is a dangerous gas.
- It can cause unconsciousness and can be lethal if inhaled.
- If at any time you suspect that exhaust gases are entering the vehicle, have the vehicle inspected and repaired immediately by a Ssangyong Dealer or Ssangyong Authorized Service Operation. If it is necessary to drive under such conditions, do so only with all windows fully open.
- To protect against exhaust gases entering the vehicle, the exhaust system and body should be inspected:
 - each time the vehicle is raised for an oil change.
 - whenever a change is noticed in the sound of the exhaust system.
 - whenever the exhaust system, under body or rear of the vehicle is damaged or becomes corroded.
- Do not operate the engine in confined areas such as garages or other closed areas any more than needed to move the vehicle in or out of the area.
- When the vehicle is stopped in an unconfined area for more than a short time with the engine running, place the air intake lever to the fresh air mode to draw the outside air into the vehicle and set the fan switch to high speed.
- Never sit (or leave the children) in a parked or stopped vehicle for any extended period of time with the engine running.
- Avoid driving with tailgate open, as exhaust gases could enter the vehicle. If you must drive with the tailgate open, close all windows, place the air intake lever to the fresh air mode to draw the outside air into the vehicle, and set the fan switch to high speed.

HAZARDOUS DRIVING

When hazardous driving is encountered because of water, snow, ice, mud, sand or similar hazard, follow these suggestions.

- Drive cautiously and allow extra distance for braking.
- Avoid sudden movements in braking or steering.
- When braking depress the brake pedal with a light up-and-down motion until the vehicle is stopped.
- If stalled in snow, mud or sand, use 2 (second) gear (for manual transmission) or "WINTER" mode (for automatic transmission) and accelerate slowly. Accelerate slowly to avoid spinning.
- Use sand, rock salt, tyre chains, or other nonslip material under the rear wheels to provide traction when stalled in ice snow or mud.



3

INSTRUMENTS AND CONTROLS



K140_RHD_EN_03.p65

1



2004-11-11, 14:08





3-2 INSTRUMENTS AND CONTROLS

INSTRUMENTS AND CONTROLS WITH MANUAL TRANSMISSION

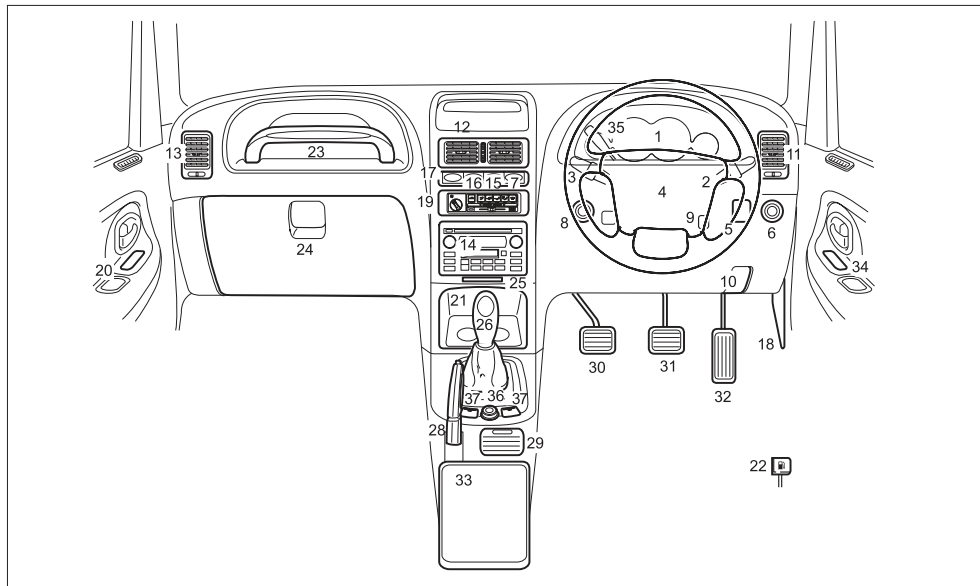



INSTRUMENTS AND CONTROLS WITH AUTOMATIC TRANSMISSION

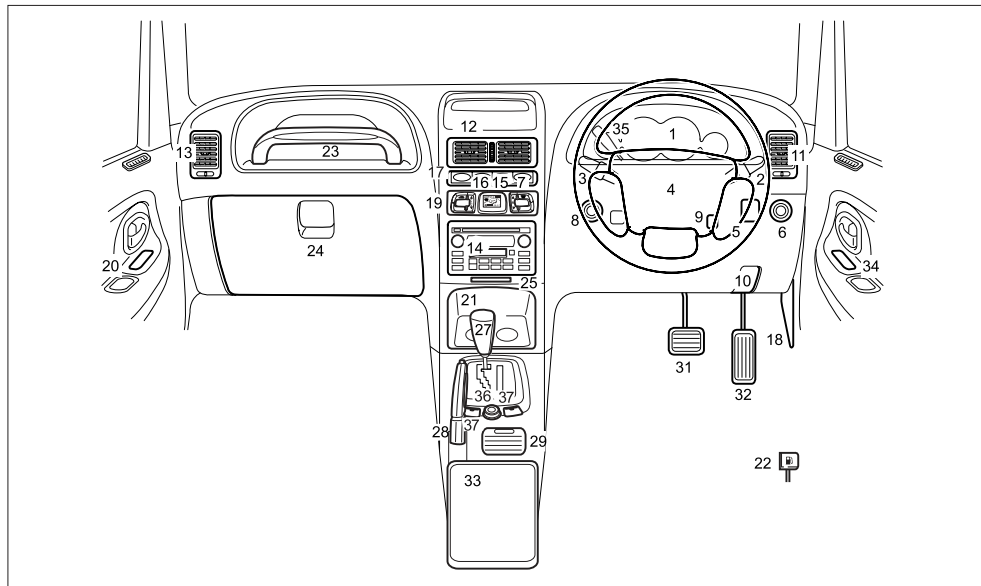



3-4 INSTRUMENTS AND CONTROLS

- | | | |
|---|--|------------------------------------|
| 1. Instrument cluster | 14. Audio | 30. Clutch pedal (M/T) |
| 2. Light switch, Turn signal switch, Front fog lamp switch* | 15. Defogger switch | 31. Brake pedal |
| 3. Windshield wiper and washer switch | 16. Rear fog lamp switch* | 32. Accelerator pedal |
| 4. Steering wheel | 17. - | 33. Armrest console box |
| 5. Outside rearview mirror adjusting switch | 18. Fuse box (In car) | 34. Power window switch (driver's) |
| 6. Tailgate window wiper and washer switch | 19. Heater/Air conditioner control panel | 35. Cruise control lever* |
| 7. Hazard warning flasher switch | 20. Power window switch (passenger's) | 36. Cigarette lighter |
| 8. 4-wheel drive switch | 21. Ashtray & Cup holder (front) | 37. Seat warmer switch* |
| 9. Steering wheel adjuster | 22. Fuel filler door release lever | |
| 10. Engine hood release handle | 23. Assist grip* | |
| 11. Side ventilation vents (left) | 24. Glove box | |
| 12. Side ventilation vents (center) | 25. Ticket holder | |
| 13. Side ventilation vents (right) | 26. Shift lever (M/T) | |
| | 27. Shift lever (A/T)* | |
| | 28. Ashtray & Cup holder (center) | |
| | 29. Parking brake lever | |

INSTRUMENTS

Diesel engine

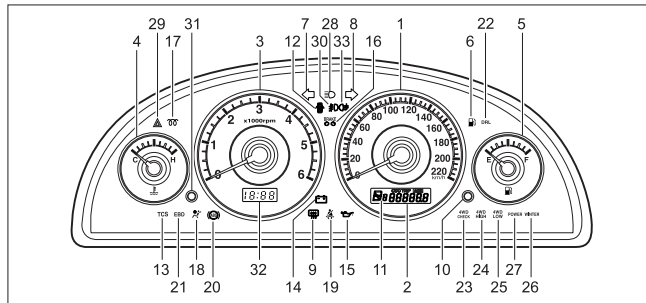

- | | | |
|--------------------------------------|--|-------------------------------|
| 1. Speedometer | 12. Door open warning light | 23. 4WD warning light* |
| 2. Odometer & Trip odometer | 13. TCS indicator* | 24. 4WD high indicator* |
| 3. Tachometer | 14. Alternator warning light | 25. 4WD low indicator |
| 4. Temperature gauge | 15. Engine oil pressure warning light | 26. WINTER mode indicator |
| 5. Fuel gauge | 16. Brake system warning light | 27. POWER mode indicator |
| 6. Low fuel level warning light | 17. Glow indicator (For Diesel engine) | 28. High beam indicator |
| 7. Turn signal indicator (left) | 18. Airbag warning light* | 29. Hazard indicator* |
| 8. Turn signal indicator (right) | 19. Seat belt reminder | 30. Front fog lamp indicator* |
| 9. Tailgate glass defogger indicator | 20. ABS warning light* | 31. Time setting knob |
| 10. Reset button | 21. EBD warning light* | 32. Digital clock |
| 11. Auto shift indicator* | 22. Day time running light indicator* | 33. Rear fog lamp indicator* |

3-6 INSTRUMENTS AND CONTROLS

Gasoline engine

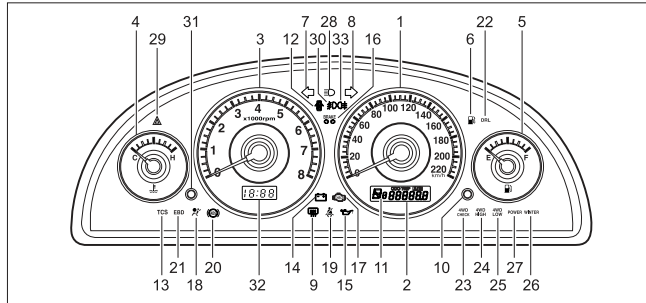

- | | | |
|--------------------------------------|---|-------------------------------|
| 1. Speedometer | 13. TCS indicator* | 23. 4WD warning light* |
| 2. Odometer & Trip odometer | 14. Alternator warning light | 24. 4WD high indicator* |
| 3. Tachometer | 15. Engine oil pressure warning light | 25. 4WD low indicator |
| 4. Temperature gauge | 16. Brake system warning light | 26. WINTER mode indicator |
| 5. Fuel gauge | 17. Malfunction indicator lamp
(For Gasoline engine) | 27. POWER mode indicator |
| 6. Low fuel level warning light | 18. Airbag warning light* | 28. High beam indicator |
| 7. Turn signal indicator (left) | 19. Seat belt reminder | 29. Hazard indicator* |
| 8. Turn signal indicator (right) | 20. ABS warning light* | 30. Front fog lamp indicator* |
| 9. Tailgate glass defogger indicator | 21. EBD warning light* | 31. Time setting knob |
| 10. Reset button | 22. Day time running light indicator* | 32. Digital clock |
| 11. Auto shift indicator* | | 33. Rear fog lamp indicator* |
| 12. Door open warning light | | |

SPEEDOMETER

The speedometer indicates the vehicle speed in kilometers per hour (km/h) or mile per hour (m/h).

TACHOMETER

The tachometer indicates engine speed in revolutions per minute.

CAUTION

*Excessive speed can damage engine.
Do not let engine reach excessive speed, indicated by pointer being in red zone.*

Diesel Engine & Gasoline

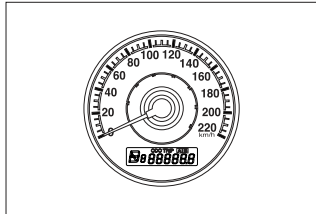

Gasoline Engine

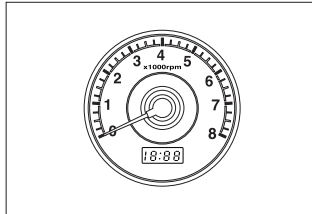

Diesel Engine

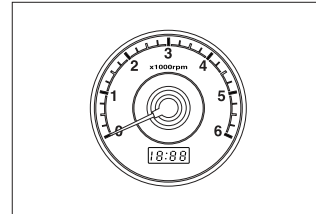

ODOMETER AND TRIP ODOMETER

By pressing the reset button (arrow), the display mode changes as shown in order.



Mode Changes

When pressing the reset button located in the right and lower area of odometer once, the first driving distance (TRIP A) will be indicated. If pressing it again, the second driving distance (TRIP B) will be indicated. When pressing it once more, total distance (ODO) will be indicated.

- Trip Odometer



Driving distance in a specific range
(unit: 0.1 km, 0 – 999.9 km)

- Odometer



Total driving distance
(unit: 1 km, 0 – 999999 km)

Trip Odometer Reset

To reset, press the reset button for 3 or 4 seconds.

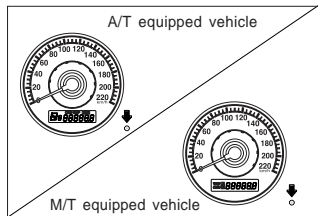

TEMPERATURE GAUGE

The temperature gauge indicates the temperature of engine coolant when the ignition switch is in the "ON" position.

- H : hot
- C : cool

CAUTION

The engine can overheat.

- *If the pointer reaches the red zone, stop the vehicle.*
- *Allow engine to cool.*

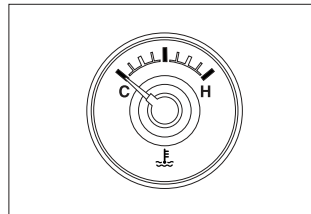

FUEL GAUGE

This gauge indicates the level of fuel remaining in the fuel tank.

The gauge continues to indicate the fuel level even after the ignition is turned off. When the fuel is added, the gauge slowly changes to the new fuel level after the ignition is turned on.

The needle moves when braking, accelerating or making turns. This is caused by the movement of the fuel in the tank.

- F : full (Fuel tank capacity : 70 liters)
- E : empty

LOW FUEL LEVEL WARNING LIGHT

This warning light indicates that the fuel will soon be exhausted.

Fill up the fuel tank as soon as possible if this warning light comes on.

CAUTION

Running out of fuel could cause damage to the catalytic converter. Fill up fuel tank as soon as possible when warning light comes on.

ENGINE OIL PRESSURE WARNING LIGHT

This warning light comes on when the ignition is switched on (as a check of bulb operation) and should go out after the engine is started. If the light comes on while driving, it indicates that the oil pressure is dangerously low. Stop the engine immediately and check the engine oil level. If the oil level is low, add the specified engine oil to the proper level.

If the oil level is normal, have the lubricating system checked at the nearest Ssangyong Dealer.

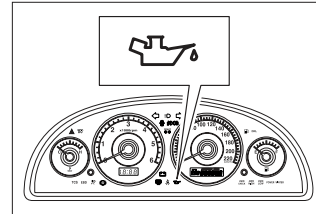
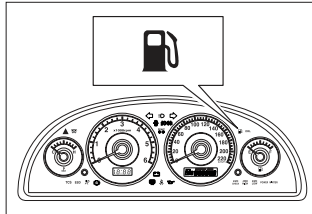
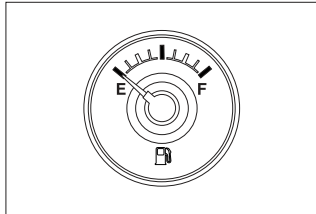

MALFUNCTION INDICATOR LAMP

CAUTION

Severe engine damage could result.

- *Do not run the engine with the engine oil pressure warning light illuminated.*
- *If driving stop the vehicle.*
- *Check oil level, if necessary add oil.*
- *If oil level is normal, take vehicle to Ssangyong Dealer or Ssangyong Authorized Service Operation.*

Illuminates briefly as you turn the ignition ON, before you start the engine. This means that the indicator bulb is operating, properly. The lamp should go out after the engine is started.

CAUTION

Do not drive with the malfunction indicator lamp on.

The indicator lamp signals that your vehicle has a problem that requires attention.

Driving with the malfunction indicator lamp on can damage the emissions control system and can affect the fuel economy and drivability of your vehicle.

Consult a Ssangyong distributor or a Ssangyong Authorized Service Operation to repair the problem as soon as possible.

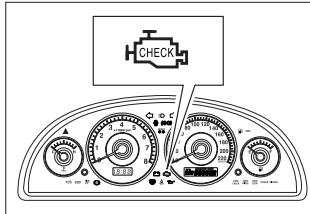

Your vehicle was designed in compliance with European On Board Diagnostic (EOBD) requirements which were specified by European Economic Community Directive.

The Malfunction Indicator Lamp (MIL) will illuminate if a fault exists in the emission related components or related sub systems. It will stay on as long as the Engine Control Unit (ECU) detects the fault.

If a severe misfire level is detected, fuel is cut automatically to avoid catalytic converter damage.

Your vehicle's electronic system will switch to an emergency running program so you may continue to drive.

However, you should consult a Ssangyong Distributor or Ssangyong Authorized Service Operation to repair the problem as soon as possible.

If your vehicle is equipped with an automatic transmission, see "Emergency Shifting Procedure" on page 2-10.

BRAKE SYSTEM WARNING LIGHT

This warning light comes on when the parking brake is applied with the ignition on and goes out when the parking brake is released. On vehicle with the ABS, this warning light comes on when the ignition is switches on, and goes out after about 3 seconds. (But, if the parking brake is applied, this warning light still remains on until the parking brake released.)

Make sure the parking brake is fully released before driving.

If this warning light comes on even when the parking brake is completely released, it may indicate that the brake fluid in the reservoir is low. Then ;

1. Pull off the road and stop carefully.
2. Check the brake fluid and add the recommended brake fluid up to the MAX mark.
3. If the brake operates normally and you judge it to be safe, drive carefully at a safe speed to the nearest Ssangyong Dealer for inspection immediately.
4. If leaks are found, if the warning remains on, or if the brakes do not operate properly, have the vehicle towed to nearest Ssangyong Dealer for inspection and repairs.

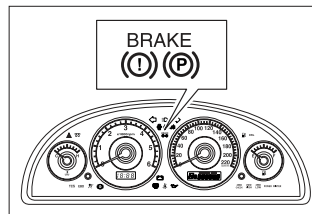

WARNING

Driving the vehicle with the brake fluid warning light on is dangerous. Have the brake system checked and repaired immediately by nearest Ssangyong Dealer.

CAUTION

The brake system warning light may not come on with parking brake applied and ignition on, indicating brake system fault.

- *Check for bulb failure.*
- *If bulb is working properly, have brake system checked.*

NOTE

Low brake fluid level may increase the stopping distance and require greater pedal effort as well as greater pedal travel.

ABS WARNING LIGHT*

This warning light illuminates when the ignition is switched on and should go out after about 2 seconds.

If this light doesn't come on when the ignition is switched on or if this light doesn't go out, contact your nearest Ssangyong Dealer or Ssangyong Authorized Service Operation.

If this light illuminates while driving, a malfunction of ABS is indicated. In this case the brake system performs its regular function but without the anti-locking capability. Have the system checked by Ssangyong Dealer as soon as possible if this condition occurs.

WARNING

If the brake system warning light and ABS warning light illuminate at the same time while driving, it may indicate a failure in the base brake system due to the malfunction of ABS.

- *Stop the vehicle and consult your Ssangyong Dealer.*
- *Have the system checked and repaired immediately before continuing your journey.*

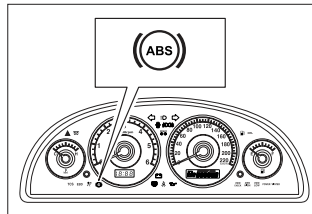

EBD WARNING LIGHT*

When the ignition is switched on, this warning light comes on and should go out after about 2 seconds.

If the EBD warning light fail to go out, this indicates that the ABS is switched off because of a fault.

Have the system check and repair immediately by your nearest Ssangyong Dealer.

DOOR OPEN WARNING LIGHT

This light comes on when a door is either opened or not closed completely.

CAUTION

Driving with door open can cause injury to people inside and outside the vehicle.

- *Before driving off, close all doors.*
- *Check warning light is off.*

BATTERY CHARGE WARNING LIGHT

This warning light indicates that the battery is being discharged.

When the ignition is switched on, this warning light comes on and should go out when the engine is started.

If the light illuminates while driving,

- Pull off the road and stop your car.
- Check the alternator drive belt for looseness or breakage.
- If the belt is OK, there is a problem somewhere in the charging system. The problem should be located and corrected as soon as possible. Have the system checked and repaired immediately by your nearest Ssangyong Dealer.

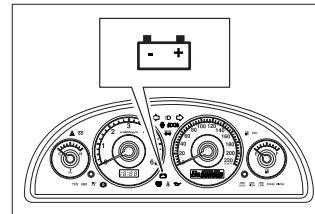
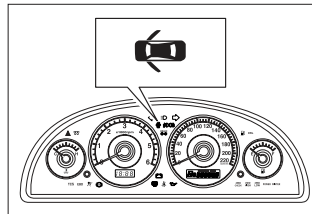
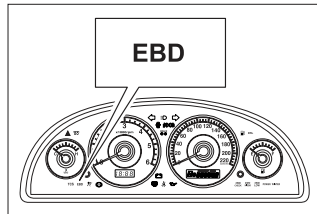

CAUTION
Do not continue driving if the belt is loose or broken. Engine can overheat, damaging engine.

SEAT BELT REMINDER

The seat belt warning light comes on whenever the ignition switch is placed in the "ON" position unless the driver's seat belt is securely fastened. Also the seat belt warning chime will sound for about 6 seconds when the ignition switch is in the "ON" position unless the driver's seat belt is secured fastened. Attention should be paid to ensure that the seat belts are fastened before driving off.

AIR BAG WARNING LIGHT*

When the ignition is switched on, this warning light illuminates for approximately 6 seconds and should go out, to confirm that the air bag is operational. If it does not come on, or if it does not go out after 6 seconds, or if it flashes or illuminates continuously while driving, it means that there is malfunction in the system. The air bag system would therefore not be triggered in the event of an accident. Have the air bag system checked without delay by a Ssangyong Dealer or Ssangyong Authorized Service Operation. See page 1-34 for details on the air bag.

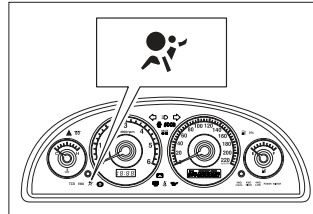
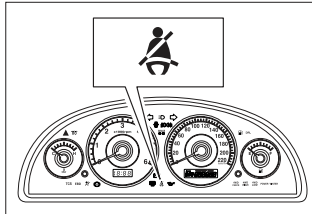

TURN SIGNAL/HAZARD WARNING FLASHER INDICATOR

When the turn signal switch is turned on, this indicator flashes to indicate operation of the external turn signal.

Shorter flashes indicate the failure of a turn signal lamp bulb.

Both right and left lights flash when the hazard warning switch is turned on.

NOTE

If a bulb is burned out, replace it immediately to help avoid an accident. If the indicating arrows don't go on at all when you signal a turn, check the fuse and for burned-out bulbs.

HIGH BEAM INDICATOR

This indicator illuminates when the headlight high beam is switched on.

FOG LAMP INDICATOR (FRONT & REAR*)

The indicator comes on when the front fog lamps are switched on.

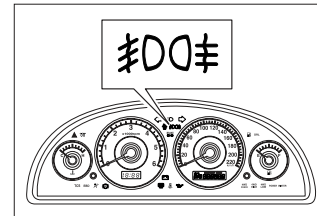
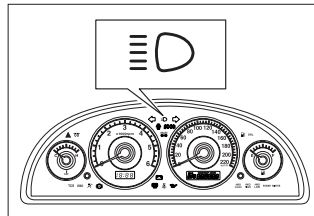
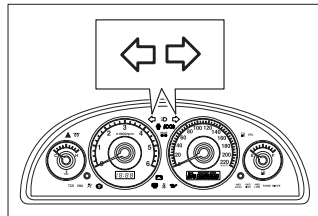

TAILGATE GLASS DEFOGGER INDICATOR

The indicator comes on when the tailgate glass defogger is switched on.

TCS (TRACTION CONTROL SYSTEM) INDICATOR*

The TCS indicator comes on briefly as you turn the ignition ON. This means the indicator bulb is operating properly. The indicator should go out after about 2 seconds. If the indicator stays on, the system should be checked as soon as possible by Ssangyong Dealer.

NOTE

During driving, the light flashes only when the TCS is operating. The TCS will be operated up to 60km/h because of safety driveability. Drive your vehicle slowly when the TCS is operating.

GLOW INDICATOR (For Diesel Engine)

This indicator comes on when the ignition switch is turned on and stays on for a short time or may go off right away. The waiting time will vary according to the engine coolant temperature. When the glow plugs are sufficiently heated for cold starting, the indicator will go out. Then, the engine should be started.

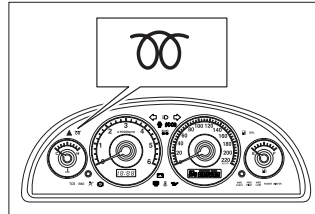
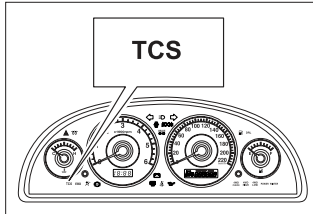
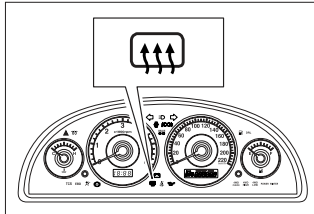



WINTER MODE INDICATOR

The indicator will come on when the winter mode ("WINTER") switch is selected. Use this mode to drive off smoothly under icy and slippery road.

POWER MODE INDICATOR

The indicator will come on when the power mode ("POWER") switch is selected. Use this mode if you need more power during abrupt acceleration, driving on the steep hill.

AUTO SHIFT INDICATOR*

The indicator comes on when the ignition switch is ON and the indicator shows the automatic transmission selector lever position.

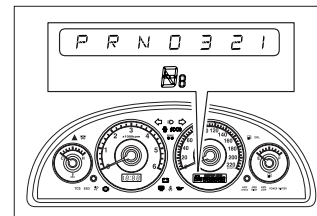
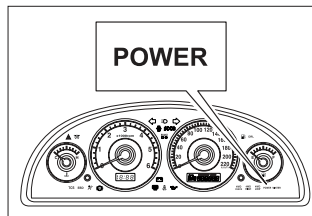
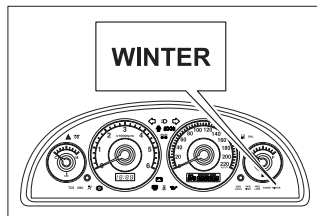

4WD INDICATOR

4WD - Part time

The "4WD HIGH" or "4WD LOW" indicator comes on when the 4WD switch is in "4H" or "4L" position.

CAUTION

Both "4WD HIGH" and "4WD LOW" come on simultaneously when there is malfunction in part time 4WD System.

4WD - TOD*

The "4WD LOW" indicator comes on when the 4WD switch is in "4L" position.

CAUTION

To shift into '4L' or '4H', completely stop the vehicle and always press the clutch pedal, for manual transmission, or position the selector lever to "N", for automatic transmission, and turn the 4WD switch to '4L' or '4H'.

DIGITAL CLOCK

When the ignition switch is turned on, the time will be digitally displayed on the clock face below the tachometer. To set time, press the knob for the following functions.

To advance the hour indicated, rotate the adjusting knob counterclockwise while pushing the knob.

To advance the minute indicated, rotate the adjusting knob clockwise while pushing the knob.

NOTE

When disconnecting the battery or replacing the fuse, the clock should be adjusted again.

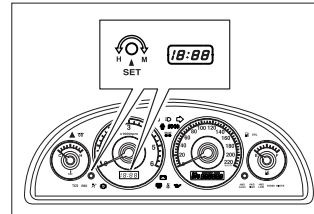
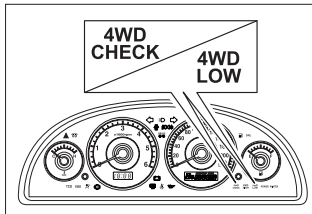
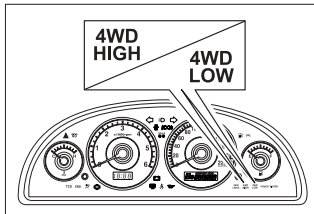

LIGHT SWITCH

To turn the light on or off, rotate the knob on the end of the combination switch lever.

There are three position;

“OFF” Position

All lights are off.

**Position**

Position, tail, license plate and instrument panel lights are illuminated.

**Position**

Headlight (low beam) and all the above lights are illuminated.

NOTE

The asymmetrical low beam increases the field of vision on the right-hand side of the lane. When driving in countries which drive on the left, the 15° section of the headlamp lenses must have a black cover strip applied.

Battery Saver (Automatically turns off the lights)

To prevent the battery from discharging, the tail lamp will be go out automatically when a driver gets off (remove key, open and close the driver's door) with the tail lamp ON. When inserting the key into key switch, the tail lamp comes again.

LIGHT SWITCH WARNING CHIME

The chime sounds to remind you to turn off the lights if the driver's door is opened with them switched on when the ignition key is removed.

CAUTION

*Battery will discharge.
Do not leave the lights on while engine is off.*

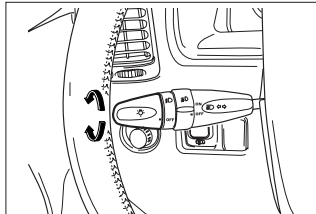

DAYTIME RUNNING LIGHTS INDICATOR*

Indicates the daytime running lights are on.

If so equipped, the daytime running lights illuminate automatically when the ignition is ON and the parking brake is released.

The daytime running lights will turn off under the following conditions:

- Ignition is turned off.
- Parking brake is engaged.
- High-beam lamps on.
- Low-beam lamps on.

TURN SIGNAL SWITCH

Move this lever up to the stop position to signal a right turn.

Move this lever down to the stop position to signal a left turn.

When the turn is completed, the signal will be cancelled and the lever will be returned to the normal position.

When changing lanes, move the switch part way and hold it there. When released, the switch will spring back to the normal position.

CAUTION

*Battery will discharge.
Do not leave the lights on while engine is off.*

HIGH BEAM SWITCH

To turn on the high beam headlights push the lever towards the instrument panel with the low beam headlights on.

The headlight high beam indicator light in the instrument panel comes on when the headlights are on high beam.

For low beam headlights, pull the lever back towards the steering wheel to the normal position.

NOTE

The light switch must already be in the  position.

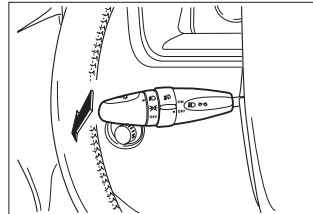
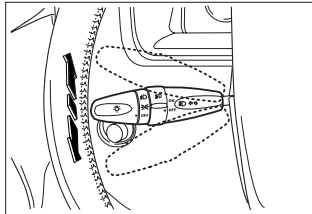
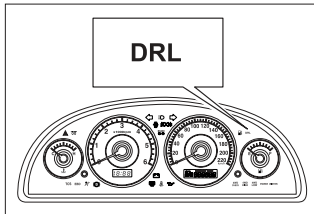





INSTRUMENTS AND CONTROLS 3-21

PASSING LIGHT SWITCH

To flash the high beam, pull the lever towards the steering wheel and release it. The lever will be returned to the normal position when released. The high beam headlights stay on as long as you hold the lever.

FRONT FOG LAMP SWITCH*

Fog lamps provide auxiliary illumination and improve vision in fog or snow. To turn on the front fog lamps, rotate the fog lamp knob on the combination switch lever to the  or  position.

To turn off the front fog lamps, rotate the fog lamp knob to "OFF" position.

WINDSHIELD WIPER SWITCH

To operate the windshield wipers, move the wiper lever in 3 downwards steps with the ignition on.

OFF = off
AUTO = Automatic wipe
LO = Continuous wipe, slow speed
HI = Continuous wipe, fast speed

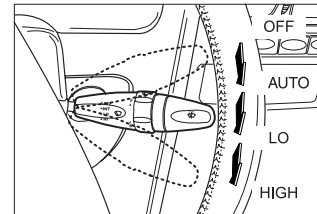
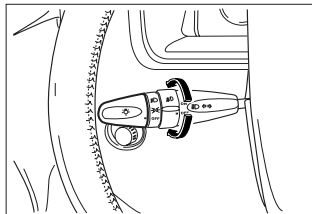
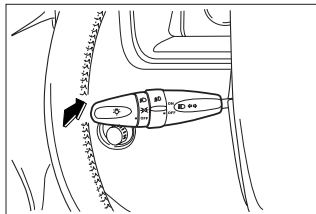

Intermittent Wiper Control

The interval of wiper swings can be adjusted by twisting the control knob upward or downward when the windshield wiper switch is in "INT" position.

- F : Fast interval
- S : Slow interval

The intermittent wiper operates automatically according to the vehicle speed when the wiper switch is in the "INT" position.

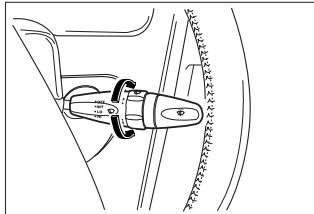
**CAUTION**

Wiper operation on dry windshield can scratch glass and wear the blades prematurely. Do not operate wipers when windshield is dry.

CAUTION

Wiper operation with obstructions, such as snow, can damage wiper motor. Clear obstruction before operating.

CAUTION

Wiper blades can freeze to windshield in cold weather. Wiper operation while blade is frozen can damage wiper motor. Check blades not frozen to windshield before operating.

WINDSHIELD WASHER SWITCH

To spray washer fluid on the windshield, pull the lever towards the steering wheel with the ignition on.

When you pull the lever for less than about 0.6 seconds, the washer fluid is sprayed onto the windshield, but the windows wipers are not operated.

When you pull the lever for more than about 0.6 second, the washer fluid is sprayed onto the windshield while you pull the lever and then the windshield wipers are operated for several cycles. When you release the lever, the wipers automatically returns to the rest position.

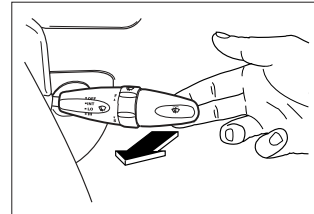

TAILGATE WINDOW WIPER AND WASHER SWITCH

CAUTION

In freezing weather, washer fluid can form ice on windshield, blocking forward vision. Warm windshield before operating washer.

CAUTION

The washer motor can be overheated and damaged.

- *Do not operate the washer when washer fluid tank is empty.*
- *Do not operate the washer continuously for more than 10 seconds.*

The tailgate window wiper and washer switch has two position.

1. **O** : OFF
2. **ON** : ON

To operate the tailgate window wiper, rotate the switch to "ON" position.

To spray the washer fluid, push the switch fully.

CAUTION

Replace the blade when it is worn or when it no longer wipers properly, to avoid loss of vision when in use.

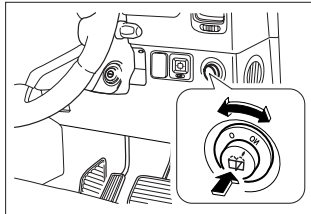

CAUTION

Tailgate window can be scratched or wiper blade can be worn prematurely. Do not operate the wiper when the window is dry.

CAUTION

In cold weather, washer fluid can form ice on rear window, blocking your vision. Warm rear window before operating washer.

CAUTION

Wiper blades can freeze to rear window in cold weather. Wiper operation while blade is frozen can damage wiper motor. Check that blade is not frozen before operating.

CAUTION

Washer motor will be overheated and damaged. Do not operate the washer when washer fluid tank is empty or continuously for more than 10 seconds.

CRUISE CONTROL* (FOR GASOLINE ENGINE)

Cruise control is an automatic speed control system that maintains a desired driving speed without using the accelerator pedal. The vehicle speed must be greater than 36km/h to engage cruise control. This feature is especially useful for freeway driving.

CAUTION

Improper use of cruise control could be dangerous.

- **Do not use on winding roads.**
 - **Do not use in heavy traffic.**
 - **Do not use on slippery, wet roads.**
- This could result in a loss of control, collision, and/or personal injuries.**

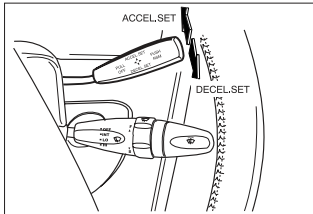

Setting a Desired Speed

1. To operate the cruise control, accelerate to your desired speed using the acceleration pedal more over 36km/h.
2. When the desired speed is reached, push up the ACCEL.SET. switch of a cruise control lever or push down the DECEL.SET. switch for 1 second per one switching and then release the acceleration pedal, slowly.
3. Now, the vehicle is cruised by this system with set speed.
4. And you can set to other vehicle speed again with above steps after acceleration pedal intervention during cruise control running.

Accelerating With Cruise Control System

- While cruise control system is running
 1. Push up the ACCEL.SET. switch of a cruise control lever and hold it until the desired speed is reached without an acceleration pedal intervention.
 2. When the desired speed is reached, release the lever.
- While cruise control system is not running
 1. Accelerate using the acceleration pedal more over 36km/h.
 2. Push up the ACCEL.SET switch of a cruise control lever and hold it.
 3. And then release the acceleration pedal, slowly.
 4. When the desired speed is reached, release the lever.



- Tap up while cruise control system is running
 1. Push up the ACCEL.SET. switch of a cruise control lever less than 0.5 second per one switching while the cruise control system is running. This is a tap up switching.
 2. When you operate a tap-up switching, the vehicle is accelerated for 1.3km/h over the previous set speed.
 3. If you want to accelerate for 13km/h, operate the tap-up switching ten times without accelerating with cruise control system.
- **Decelerating with cruise control system**
 - While Cruise control system is running
 1. Push down the DECEL.SET. Switch of a cruise control lever and hold it until the desired speed is reached without a brake pedal intervention. But the cruise control system cannot maintain the cruise function at less than 34km/h.
 2. When the desired speed is reached, release the lever.
 - When Cruise control system is not running
 1. Push down the DECEL.SET. Switch of a cruise control lever and hold it.
 2. And then release the acceleration pedal, slowly.
 3. When the desired speed is reached, release the lever. But the cruise control system cannot maintain the cruise function at less than 34km/h.
- Tap down while cruise control system is running
 1. Push down the DECEL.SET. Switch of a cruise control lever less than 0.5 second per one switching while the cruise control system is running. This is a tap down switching.
 2. When you operate a tap-down switching, the vehicle is decelerated for 1km/h below the previous set speed.
 3. If you want to decelerate for 10km/h, operate the tap-down switching ten times without brake pedal intervention.

Recovery of set speed

Even if the cruise control is canceled, the previous set cruise speed can be recovered by pushing toward the RSM (resume) switch of a cruise control lever when the current vehicle speed is higher than 36km/h without acceleration intervention. But if you turn off the ignition switch, the memorized set speed is cleared and you cannot recover the previous set speed.

CAUTION

The resume position should only be used if the driver is fully aware of this speed and wishes to resume this particular speed.

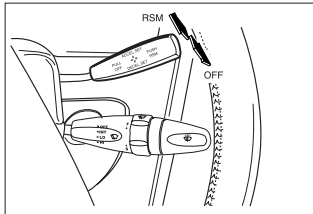
**Normal Cancellation of cruise control**

The cruise control system will be canceled when one or more items of the following conditions is applied;

1. When the brake pedal is depressed.
2. When the cruising speed is downed less than 34km/h.
3. When the off switch is operated by pulling rearward the cruise control lever.
4. When ABD is activated.

And the cruise control system can be operated again in driving state.

CAUTION

Keep the main cruise control switch as neutral position when not using the cruise control.

Abnormal Cancellation of cruise control

1. When the rapid deceleration is applied without braking.
2. When the rapid acceleration is applied without acceleration pedal intervention.
3. When the cruise control lever is failed.
4. When the brake switch and brake light switch input signal is implausible.

And the cruise control system cannot be operated again in driving state. In this case, you should stop the vehicle, and turn off the ignition switch and then turn it on again. After you do that, you can use the cruise control system again. But if the cruise control system isn't recovered, you should contact Ssangyong Dealer for diagnosis of the cruise control system.

CAUTION

Abnormal changes of the selector lever can damage the engine. Do not move the shift lever to Neutral while driving at the set speed. Automatic transmission damage may result.

CAUTION

- *The speed that has been set may not be maintained on uphill or downhill slopes.*
- *The speed may drop to less than the set speed on a steep uphill grade. The accelerator must be used if you want to maintain that speed.*
- *The speed may increase to more than the set speed on a steep downhill grade. When the speed increases too much, turn off the cruise control.*

Using Cruise Control on Hills

How well cruise control works on hills depends on the speed, load, and the steepness of the hill.

When going up steep hills, you may have to press the accelerator pedal to maintain your speed. When going downhill, you may have to brake or shift to a lower gear to keep your speed down.

Applying the brake takes you out of cruise control.

HAZARD WARNING FLASHER SWITCH *

To turn on the hazard warning flashers, push the hazard warning flasher switch. All turn signal lamps will flash simultaneously with the hazard warning indicators.

Push this switch again to turn them off. The switch can be operated with the ignition on or off.

Use the hazard warning flasher to warn other drivers when you stop or park under emergency conditions, or when your vehicle becomes a traffic hazard. Avoid stopping on the road if possible.

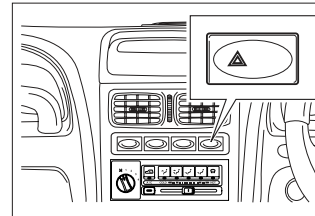

DEFOGGER SWITCH

To turn the defogger on, turn the ignition to ON and push the defogger switch. The indicator light in the switch will illuminate.

The defogger will automatically turn off after about 12 minutes.

To turn off the defogger, push the switch again.

If you turn on the switch again within 10 minutes after defogging for 12 minutes, the system will be operated for 6 minutes.

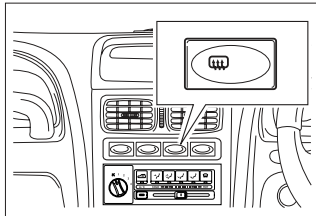

CAUTION

When cleaning the inside of tailgate window, be careful not to scratch or damage the defogger wires. Do not clean inside of tailgate window with sharp instruments or window cleaners containing abrasives.

NOTE

In snowy condition, use this defogger switch only after removing any snow from the tailgate window.

NOTE

The defogger uses a lot of power and can discharge the battery.

- *Do not use the defogger when starting the vehicle or the engine is not running.*
- *Switch off defogger when tailgate window is clear.*

REAR FOG LAMP SWITCH*

To turn on the rear fog lamp, push this switch while the front fog lamps are turned on, or while the light switch is placed in  position.

When the lamps are switched on, the indicator light in the switch will come on.

The indicator light will remain on as long as the rear fog lamps are turned on.

Pushing this switch again will turn off the rear fog lamps.

Rear fog lamps can dazzle people behind. Use rear fog lamps in severe weather conditions.

* **REAR FOG LAMP** : Mandatory where required by regulation.

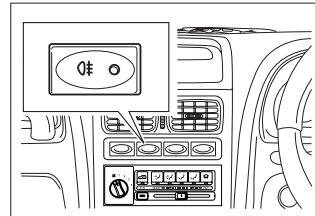

4 WHEEL DRIVE SWITCH

The indicator light will come on according to the 4WD operation.

Part Time 4WD System

To operate the 4WD, rotate the switch to '4H' or '4L'.

- 2H : 2-wheel drive, normal drive mode.
- 4H : 4-wheel drive high speed.
- 4L : 4-wheel drive low speed.

TOD 4WD System

Rotate the switch according to road condition.

- 4H : 4-wheel drive high speed, normal drive mode
- 4L : 4-wheel drive low speed

HEADLAMP LEVELING SWITCH*

With the low beam switched on, adjust the aiming angle of headlights to suit the vehicle load.

- To lower the aiming angle, push the switch downward.
- To raise the aiming angle, push the switch upward.

NOTE

According to load condition, adjust the aiming angle of headlights.

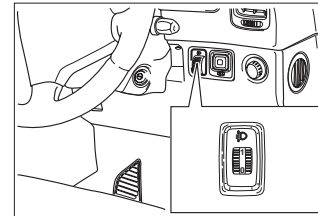
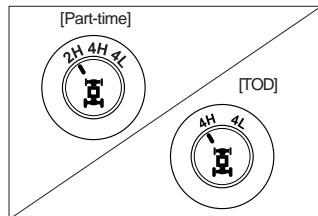

HORN SWITCH

To sound the horn, press the center of the steering wheel.
The horn sounds with the ignition switch in any position.
Keep use of the horn to a minimum.

CIGARETTE LIGHTER

To operate the cigarette lighter, open the ashtray and press it in all the way when the ignition switch is in the "ACC" or "ON" position.
When it becomes heated, it automatically pops out ready for use.

CAUTION

The barrel of the lighter becomes hot during use and can cause burns.

- Do not touch barrel of lighter.
- Do not allow children to operate or play with cigarette lighter.

CAUTION

The lighter can be overheated and this can cause a fire hazard.

- Do not hold the lighter pressed in by hand while heating.
- If the lighter does not pop out within 30 seconds, pull it out and have the problem corrected by Ssangyong Dealer.

NOTE

Use of the lighter socket for plug-in accessories can cause damage or electrical damage.

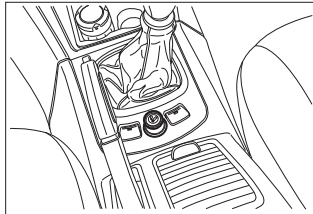
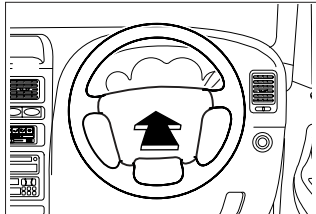



ASHTRAY

Front Ashtray

The area beside the cigar lighter is magnet for safe attachment of separate ashtray.

⚠ WARNING

Putting lit cigarettes or matches in ashtray with other combustible materials can cause a fire hazard. Do not use ashtray as a waste receptacle.

Rear Ashtray

To open the rear ashtray, pull at the edge of ashtray.

After using the ashtray, close it completely. To empty the rear ashtray, withdraw it with depressing the spring.

To install, attach at the bottom and push the ashtray back into place.

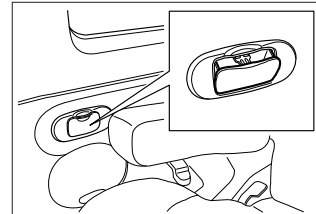
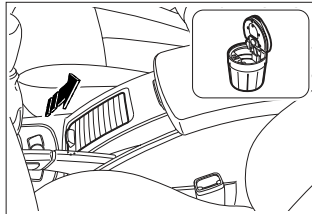
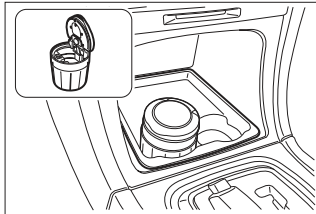

CUP HOLDER

Cup holder is in the center instrument panel console. To use the cup holder, push the surface of it slightly. It will automatically come out smoothly ready to use.

CAUTION

When vehicle is in motion, the liquid may spill out. Spilled liquid can damage the vehicle and cause burns if it is hot. Do not use cup holder while vehicle is in motion.

CENTER ARMREST CONSOLE

You can use it as an armrest or a console box to store some goods. Pull the lever to open the console box.

ASSIST GRIP

The assist grips are located above passenger's windows and rear window. Also, the assist grips of rear window include a coat hook. Another assist grip for passenger is located on instrument pannel.

WARNING

Hanging items at coat hook can obstruct rear vision.

- Do not hang any items if possible.
- Drive with care when some items are on coat hook.

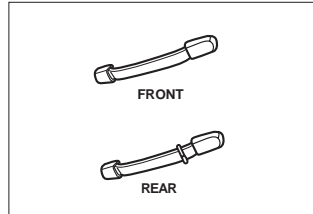
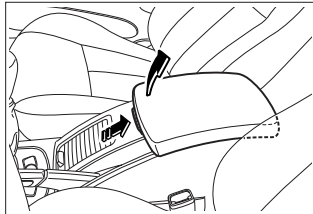
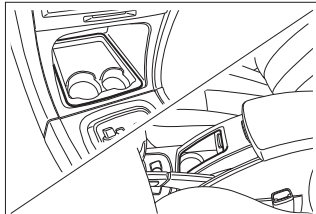



SUN VISORS

Your vehicle has padded sun visors to protect the driver and passengers from glare.

You can swing the sun visors up and down, and to the side.

The ticket holder is provided to the front face of the sunvisor on the driver side.

The vanity mirror is provided to the rear face of the sunvisor on the driver and the passenger side.

MAP POCKET

The map pocket is located on each front doors. Store map, magazine, newspaper and others in.



Driver side

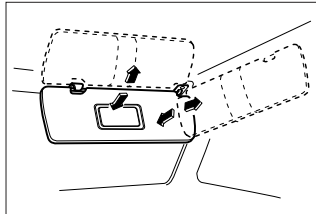

Passenger side

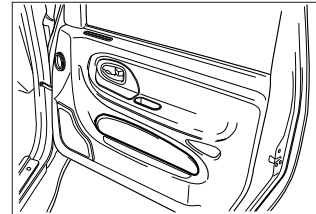
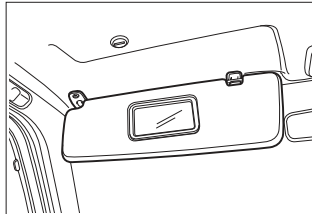

GLOVE BOX

Open the glove box by pulling the release lever.
Close it with a firm push.

WARNING

*Driving with glove box lid open can cause injury in case of an accident or a sudden stop.
Keep glove box lid closed when driving.*

LUGGAGE HOOKS

Your vehicle has luggage hooks on the luggage room floor.

WARNING

The luggage hooks should be used to secure all loads in the luggage room by using the proper straps.

ROOM LAMP

Front Room Lamp

The room lamp switch has two positions.

“DOOR” Position

The light comes on when either of the doors is opened regardless of the ignition switch position.

“SPOT” Position

The light comes on and stays on regardless of the ignition switch position.

NOTE

When the ‘DOOR’ switch is on, it begins to dim for several seconds after closing the door.

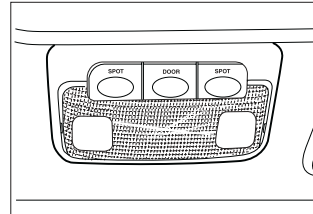
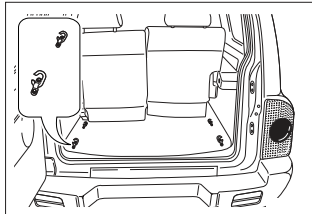
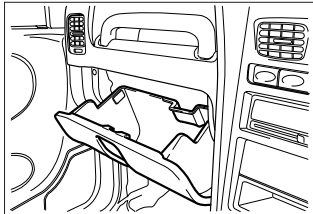



Rear Room Lamp

To turn on the light, push the switch.
To turn off the light, push the switch again.

COURTESY LIGHT

The courtesy light is located on the driver's and passenger's door to illuminate the space around the feet.

The courtesy light turns on when the door is opened regardless of the ignition switch position.

LUGGAGE ROOM LAMP

The luggage room lamp is located on lower part of leftside when you open the tailgate.

The luggage room lamp is illuminated by opening the tailgate.

To turn on the lamp, push the right part of the lamp.

To turn off the lamp, push the left part of the lamp.

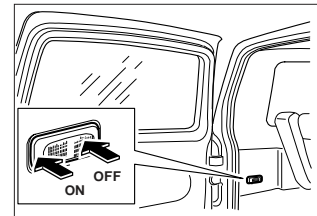
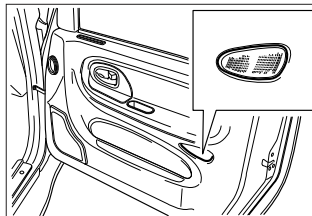
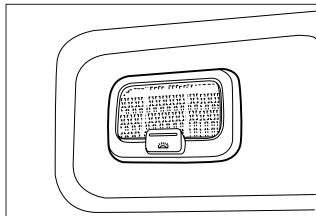



MEMO

Lined area for writing notes, consisting of 15 horizontal lines.





4

VENTILATION, HEATING AND AIR CONDITIONING*



K140_RHD_EN_04.p65

1



2004-11-11, çÄÄ 4:08



4-2 VENTILATION, HEATING AND AIR CONDITIONING*

VENTILATION AND HEATING

This system allows you to control the heating and ventilation inside your vehicle. If your vehicle is equipped with air conditioning (A/C), you also use this system to control passenger compartment cooling.

AIR VENTS

Side Vents

You can direct air through both adjustable side vents toward either side of the front passenger area, or toward the side windows.

Windshield Defroster Vents

The windshield defroster vents direct air onto the windshield.

Center Vents

You can control the direction of airflow through both adjustable center vents.

Front Foot Vents

The front foot vents direct air into the front foot area.

Rear Foot Vents

Cooled or heated air travels to the rear foot area through ducts underneath the front seats.

Front Door Window Defroster Vents

The front door window defroster vents direct air onto the side windows, mainly in the area near the outside mirror.

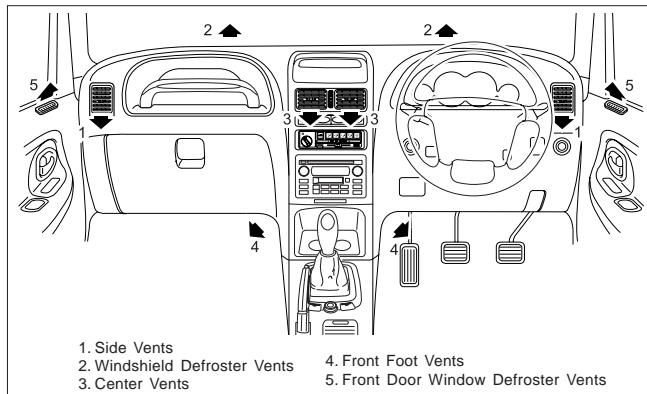

**MANUAL AIR CONDITIONING
CONTROL PANEL**

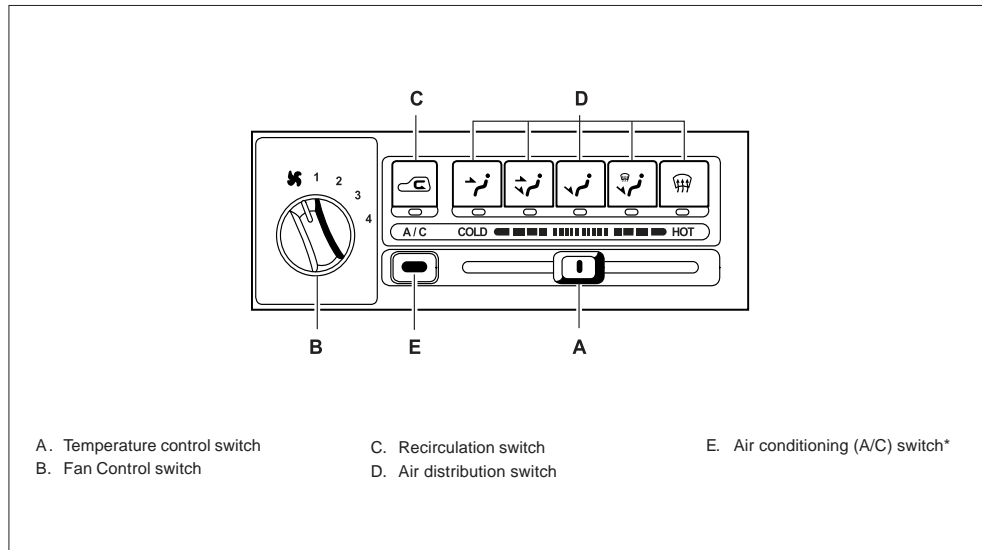

4-4 VENTILATION, HEATING AND AIR CONDITIONING*

Temperature Control Switch

The temperature control switch controls the temperature of the air that comes through the air vents.

Slide the switch to the blue area to get cool air and to the red area to get warm air.

Fan Control Switch

You may control the rate of airflow through your vehicle by using the fan speed control switch to vary the fan speed. There are four fan speeds with 1, the lowest speed, and 4, the highest speed.

For the greatest comfort, you should keep the fan on while driving.

Recirculation Switch

Press this switch when driving in dusty conditions or to avoid traffic or outside fumes, and when quick cooling or heating of the passenger area is required.

The indicator light will illuminate and interior air is recirculated.

Pressing the recirculation switch again will draw outside air into the passenger compartment. The indicator will go out.

CAUTION

Continued operation in the recirculation mode could cause interior to become stuffy and windows to fog up. Use recirculation mode in short periods of time.

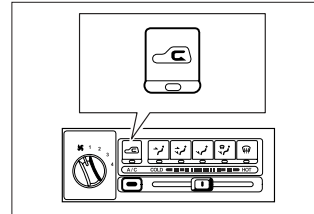
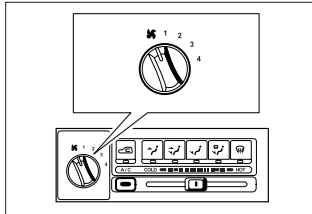
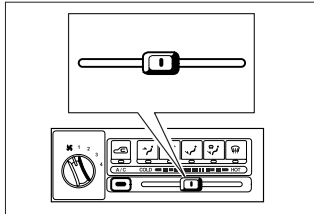

Air Distribution Switch

This switch allows you to select the outlet air flow.
This switch has the following five positions;

1. Face position
2. Bi-Level position
3. Foot position
4. Foot / Defrosting position
5. Defrosting position

1. Face Position ()

This setting directs air through the center and side vents.

2. Bi-Level Position ()

Air flows from the center, side vents and the front, rear foot vents.

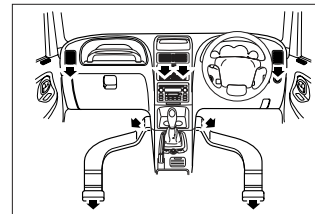
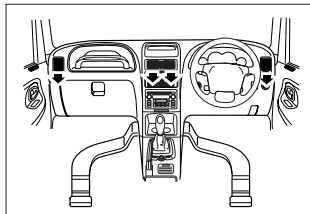
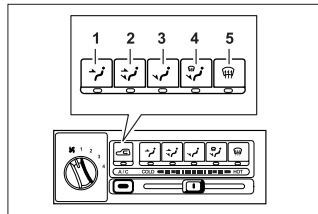

4-6 VENTILATION, HEATING AND AIR CONDITIONING*

3. Foot Position ()

Sends the majority of the air through the front, rear foot vents. The rest of the air flows from the defroster and the front door window defroster vents.

4. Foot/Defrosting Position ()

Allows half of the air to flow from the front, rear foot vents. It allows the rest of the air to flow from the defroster and the front door window defroster vents.

5. Defrosting Position ()

Directs the air to flow from the defroster and the front door window defroster vents.

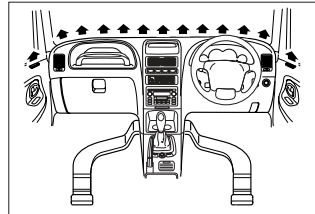
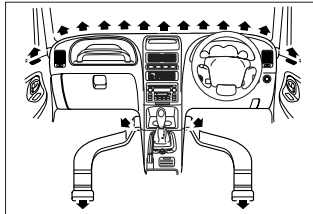
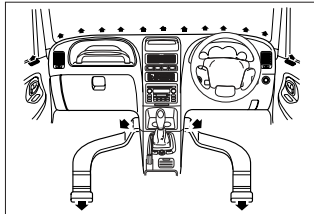

AIR CONDITIONING SYSTEM*

The refrigeration unit of the air conditioning (A/C) system cools and removes moisture from the air inside your vehicle.

Even with the A/C on, your vehicle will produce warm air if you set the temperature control switch to warm.

Air Conditioning Switch*

CAUTION

- *Using your air conditioning (A/C) system while driving up long hills or in heavy traffic can cause the engine to overheat.*
- *Vehicle can be damaged.*
- *Watch temperature gauge. Turn OFF A/C if gauge indicates engine overheating.*

To turn on the air conditioning (A/C) :

1. Start the engine.
2. Press A/C switch.
(Indicator light will come on to confirm the A/C is running.)
3. Adjust fan speed.

NOTE

The air conditioning will not operate when the fan control switch is in the off position.

To turn OFF the A/C :

1. Press A/C switch again.
(Indicator light will go off to confirm the A/C is not running.)

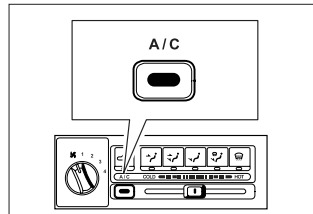



4-8 VENTILATION, HEATING AND AIR CONDITIONING*

Maximum Cooling*

To achieve maximum cooling during hot weather and when your vehicle has been exposed to the sun for a long time:

1. Open windows slightly to let warm air escape.
2. Air conditioning switch : ON
3. Recirculation switch : ON
4. Air distribution switch : 
5. Temperature switch : Slide fully left (Blue colored)
6. Fan switch : speed 4 (Maximum speed)

Normal Cooling*

1. Air conditioning switch : ON
2. Recirculation switch : OFF
3. Air distribution switch :  or 
4. Temperature switch : Blue colored
5. Fan switch : As required

Bi-Level

Use this setting on cool, but sunny days. Warmer air will flow into the floor area and cool, outside air will flow toward your upper body.

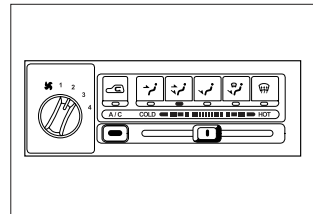
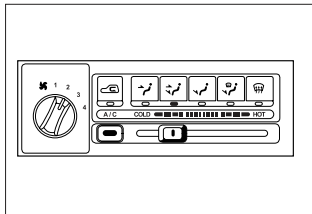
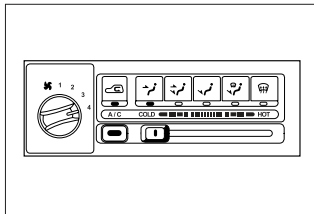

To use bi-level setting :

1. Recirculation switch : OFF
2. Air distribution switch : 
3. Temperature switch : Between cold (Blue) and hot (Red)
4. Fan switch : As required



Ventilation



To direct outside air through the center and side vents :

1. Air conditioning switch : OFF
2. Recirculation switch : OFF
3. Air distribution switch :  or 
4. Temperature switch : Blue colored
5. Fan switch : As required



Maximum Heating

Use the maximum heating mode for quick heating of the passenger area. Do not use it for lengthy periods because the interior air may become stale and the windows may fog. To clear the windows, turn off the recirculation button to allow fresh air into the vehicle.

For maximum heating :

1. Air conditioning switch : OFF
2. Recirculation switch : ON
3. Air distribution switch :  or 
4. Temperature switch : Slide fully right (Red colored)
5. Fan switch : speed 4

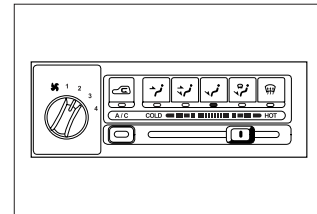
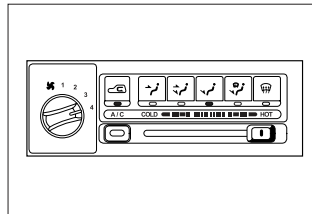
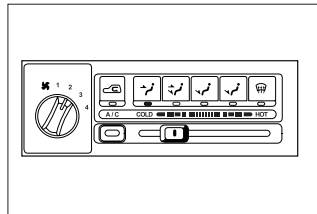

Normal Heating

1. Air conditioning switch : OFF
2. Recirculation switch : OFF
3. Air distribution switch :  or 
4. Temperature switch : Red colored
5. Fan switch : As required



Defrosting

You can operate the defroster mode with the air conditioning (A/C) system on or off.



1. Recirculation switch : OFF
2. Air distribution switch :  or 
3. Temperature switch : Red colored
4. Fan switch : As required

NOTE

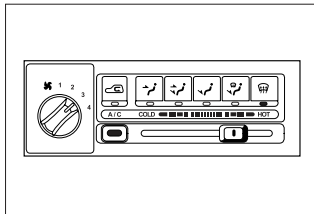
Turn on the A/C to improve the efficiency of the defroster.



CAUTION

Do not use  or  in extremely humid weather when the temperature control switch is set to the blue area for cooling.

The difference between the outside air and the temperature of the windshield can cause the windows to fog, thereby restricting your view. This can lead to an accident which can damage your vehicle and cause personal injuries.

Operating Tips for Ventilation System

If your vehicle has been parked in direct sunlight, open the windows before turning on the air conditioning (A/C).

To clear foggy windows on rainy days or in high humidity, decrease the humidity by using the A/C.

Turn on the A/C system for a few minutes at least once each week, even in winter months or when the A/C system is not being used regularly.

This maintains proper lubrication of the compressor and the seals and will prolong the service life of the system.

Driving in stop-and-go traffic may reduce the effectiveness of the A/C system.

The A/C compressor does not operate when the fan control knob is turned OFF.

Obstructions (snow, ice, leaves, etc.) on the air inlet grilles in front of the windshield can reduce the effectiveness of the ventilation, heating and air conditioning.

**AUTOMATIC AIR CONDITIONER
CONTROL PANEL**

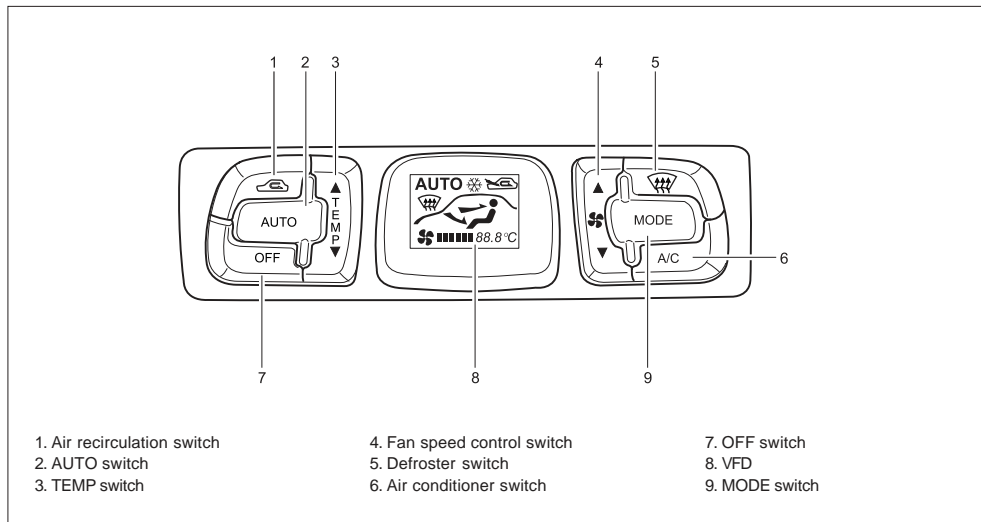

AUTO switch

Press the switch to turn on the system. On the VFD, the AUTO indicator will be comes on.

In 'AUTO' mode, the fan speed, air flow and air vent will be automatically controlled according to the adjusted temperature.

TEMP switch

You can adjust the temperature between 17°C ~ 32°C.

- Press the (▲) section of the switch to raise the temperature by 0.5°C degree.
- Press the (▼) section of the switch to lower the temperature by 0.5°C degree.

OFF switch

Press the switch to turn off the air conditioning system. The VFD also goes out.

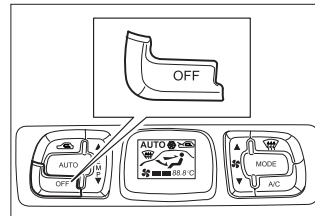
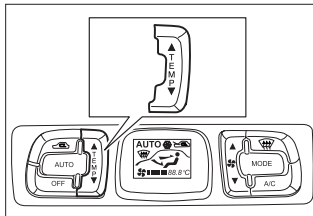
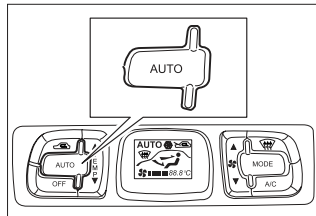

Fan speed control switch

The fan speed can be adjusted in 6 stages.

- Press (▼) on the switch to reduce the fan speed.
- Press (▲) on the switch to increase the fan speed.

When the switch is operated, the fan speed show up as bar and "AUTO" goes out.

Air conditioner switch

When you press the switch, the indicator light (☼) comes on and the air conditioner starts to operate.

When you press the switch again, the air conditioner stops operation and indicator goes out.

AUTO indicator doesn't come on during the switch operation.

Defroster switch

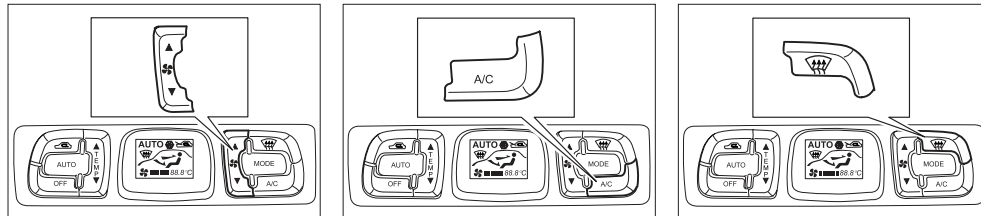

When you press the switch, the airflow direction will be changed to windshield and door glasses, the air conditioner operates automatically and outside air comes in. At this moment, the indicator (☼) comes on.

When the defrosting is completed, press the switch to return to normal operations. When the switch is operated, the air conditioner indicator (☼) and fresh air intake mode indicator (☼) comes on. At this moment, AUTO indicator goes out.



Air recirculation switch

By pressing the switch, outside air intake mode and recirculation mode changes alternatively.

When the fresh air intake mode is selected, indicator () comes on. Recirculation mode is selected () indicator comes on. When the switch is operated, the AUTO indicator goes out.

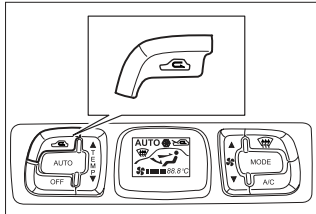

⚠ WARNING

- *Continued operation in the recirculation mode could cause interior to become stuffy and windows to fog up. Use recirculation mode in short period of time. And, it may cause a deadly intoxication if carbon monoxide has already flown into the passenger compartment. After passed through the contaminated area, press the recirculation switch again to draw outside air into the passenger compartment.*
- *In rainy or high humid condition, the difference between the outside air and the temperature of the windshield may cause the windows to fog, thereby restricting your view. This can lead to an accident which can damage your vehicle and cause personal injuries. In this case, select the fresh air intake mode with the recirculation switch and press the defroster () switch to remove the fog on the windshield.*

NOTE

When pressing the defroster () switch in air recirculation mode, the air flow direction is automatically changed to the fresh air intake mode.



MODE SWITCH

By pressing the switch, the air flow mode changes as shown in order.



When the switch is operated, the AUTO indicator goes out.

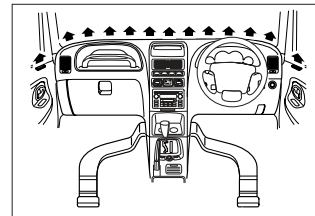
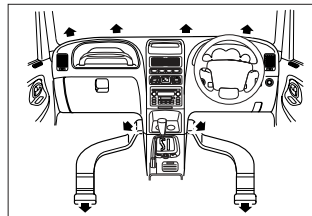
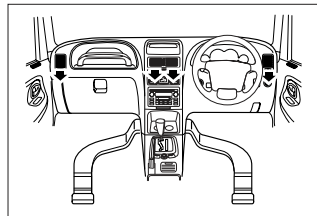
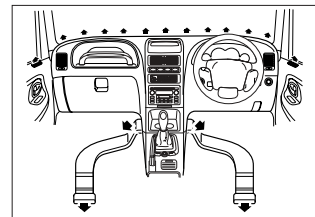
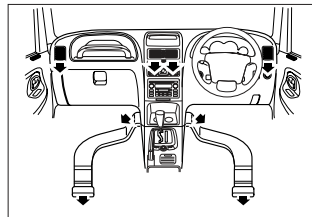

Automatic Operation

1. Set the desired temperature with TEMP switch.
2. Press the AUTO switch.
The temperature of the passenger compartment will be maintained automatically. Air flow distribution and fan speed are also controlled automatically.

Manual Operation

- Under the automatic cooling and heating, you can control the air conditioner functions manually by operating the air conditioner switch, fan speed control switch, MODE switch or air recirculation switch.
- At this moment, the AUTO indicator goes out. If you want to use full automatic functions again after manual adjustment, press the AUTO switch. At this moment, the AUTO indicator comes on.



DEFROSTING**Inside**

1. Press the defroster () switch.
 2. Turn on the fan speed switch and set it to the desired speed.
- If you want to remove the frost promptly, select the higher speed.

Outside

1. Set the TEMP switch to the higher temperature.
 2. Press the defroster () switch.
 3. Turn on the fan speed switch and set it to the desired speed.
- If you want to remove the frost promptly, select the higher speed.

CAUTION

- *When you press the switch, the airflow direction will be changed to windshield and door glasses, the air conditioner operates automatically and outside air comes in.*
- *To prevent the windows fogging, set the air recirculation switch to the fresh air intake mode.*
- *If you use the air conditioner excessively when the air flow mode is () or () , the difference between the outside air and the temperature of the windshield may cause the windows to fog. When this happens, set the air flow direction to () mode and set the fan speed switch to lower speed.*
- *Obstructions (snow, ice, leaves etc.) on the air inlet grille can reduce the effectiveness of the ventilation, heating and cooling. Thus, it may cause the windows to fog up. Please keep the area clean.*



5

TURBO CHARGER SYSTEM



K140_RHD_EN_05.p65

1



2004-11-11, 14:08



5-2 TURBO CHARGER SYSTEM

ENGINE COMPARTMENT

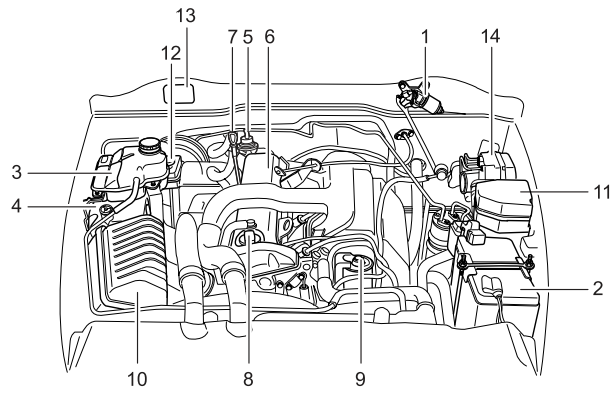

- | | | |
|---------------------------|------------------------------|--------------------|
| 1. Windshield wiper motor | 7. Engine oil level dipstick | 13. VIN plate |
| 2. Battery | 8. Engine oil filler cap | 14. ABS/ABD (TCS)* |
| 3. Coolant surge tank | 9. Fuel filter | |
| 4. Washer fluid tank | 10. Air cleaner | |
| 5. Turbo kit | 11. Fuse box | |
| 6. Engine | 12. Brake fluid tank | |

INTRODUCTION

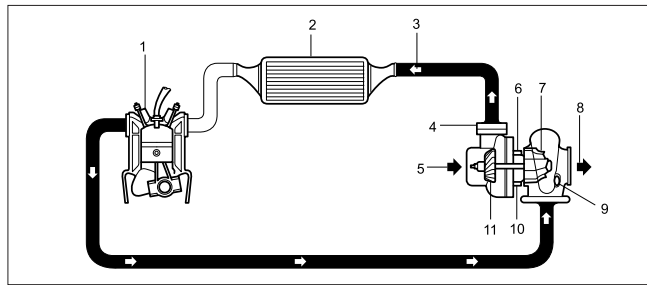

- | | |
|---------------------------|-----------------------------|
| 1. Cylinder | 7. Turbine wheel |
| 2. Intercooler | 8. Exhaust gas outlet |
| 3. Compressed air flow | 9. Bypass valve |
| 4. Compressor | 10. Turbocharger oil outlet |
| 5. Air inlet | 11. Compressor wheel |
| 6. Turbocharger oil inlet | |

Specification

Model	D29ST (Diesel)
Max. torque (N-m/rpm)	256 / 2100
Max. output (ps/rpm)	120 / 4000

What is the Turbocharger?

Turbochargers are based on gas turbine engine technology, but operate under considerably greater pressure. The turbocharger consists of two turbo elements, a turbine and a compressor, both of which are driven from the main center shaft. The turbine rotates between 50,000-160,000 spins per minute and uses the energy of the exhaust gas to drive the compressor. The compressor, in turn, draws in fresh air which it supplies to the cylinders in compressed form. As more fuel is drawn into the engine, output performance is boosted between 15-30% in comparison to a non-turbocharged engine.

Advantages of a Turbocharger

- Turbocharger helps the engine operate more smoothly and with greater efficiency.
- Increase specific power
 - Compensate for power loss at altitude
 - Reduce emissions and noise

PREVENTIVE MAINTENANCE

The vehicle owner should be encouraged to observe the following precautions to ensure maximum turbocharger service life.

CAUTION

- *Operate the engine above idle only after normal engine oil pressure has been established. Revolving up the engine, immediately after start-up, could result in damage to the turbocharger unit. Forcing the turbocharger to operate before the bearings are adequately lubricated creates unnecessary friction.*
- *Take steps to reduce temperature and speeds from their maximum before shutting down the engine.*
- *The turbocharger may need to be pre-oiled after and oil change or any service that involves oil draining. Crank the engine a few times before allowing start, then start the engine and allow it to idle for a period to establish full oil circulation and pressure before operating at higher rpm.*

CAUTION

- *At low ambient temperature, or when ever the vehicle has not been used for a long period, normal engine oil pressure and flow is affected. Under these conditions the engine should be started and allowed to idle for a few minutes before operating at a higher rpm.*
- *Avoid long periods of engine idling. The combination of low-pressures in the turbine and compressor may allow oil to seep past the seal into the turbine or the compressor.*

TURBOCHARGER INSPECTION

Good maintenance practices should be observed, particularly regarding air filtration and oil quality and filtration.

These areas are important because of a turbocharger's speed of operation.

Proper operating procedures and preventive maintenance practices enhance good turbo-service life and performance.

CAUTION

Operating the turbocharger system without the intake and exhaust manifold mounting can result in severe engine damage.

1. Turbo charger
2. Oil inlet line
3. Intercooler inlet line
4. Intake line

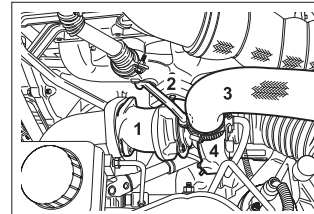



6

IN CASE OF EMERGENCY



6-2 IN CASE OF EMERGENCY

SPARE WHEEL, JACK AND VEHICLE TOOLS

The spare wheel is located on the tailgate.
Your jack and tools are located at the right side of luggage room.

- Tools
- | | |
|-----------------|--------------------|
| 1. Jack | 5. Driver (-, +) |
| 2. Wheel wrench | 6. Tools bag |
| 3. Pliers | 7. Open end wrench |
| 4. Rubber ring | |

WARNING

- Do not store jack, spare tyre, or other equipment in passenger compartment.
- In sudden stop or collision, loose equipment can be thrown around inside your vehicle and cause personal injuries.
- Always store jack, spare tyre, other tools and equipment securely in their proper location.

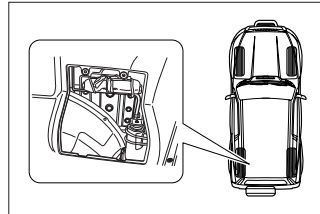
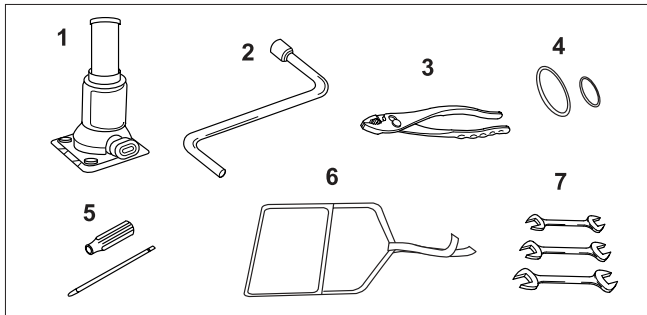

JACK SPECIFICATIONS

Safe Working Load	1300kg
-------------------	--------

⚠ WARNING

Do not use jack provided with your vehicle on other vehicles.

Ssangyong designed the jack for use on your vehicle only.

Use of this jack on other vehicles may damage the other vehicles or your jack and lead to personal injury.

The jack is intended exclusively for jacking up the vehicle when changing a wheel.

Never exceed the jack's safe working load.

Vehicle support stands must be used when working, under the vehicle.

HOW TO CHANGE A FLAT TYRE

If a tyre goes flat, follow these safety instructions before you change the tyre:

Tyre Change Safety Precautions

1. Turn on hazard flashers.
2. Move off the road to a safe place away from traffic.
3. Park on a firm and level surface.
4. Turn off engine and remove key.
5. Set parking brake.
6. If vehicle has an automatic transmission, shift to P. If your vehicle has a manual transmission, shift to first or reverse.
7. Have all passengers get out of vehicle and stand in safe a place.

8. Use a wedge, block of wood, or rocks in front of and behind the tyre that is diagonal from the tyre you plan to change.

Failure to follow these safety precautions can cause your vehicle to slip off the jack possibly causing serious injury.

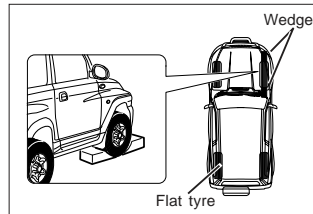

6-4 IN CASE OF EMERGENCY

Getting the Jack Connection Rod

Jack connection rod is located under the rear seats and covered by carpet.

Removing the Spare Wheel

The spare wheel is located on the tailgate.

1. Remove the key cylinder while inserting the key into the key cylinder.
2. Unscrew the nut by rotating the wheel wrench counterclockwise.
3. Remove the spare wheel carefully.

Changing a Wheel

1. Remove the spare wheel from tailgate with jacking tools.
2. Use the wheel wrench to loosen the wheel nuts one turn each.

CAUTION

Do not remove any of the nuts until you have raised that wheel off the ground.

3. Insert the jack connection rod and the wheel wrench into the jack.
4. Rotate the jack connection rod clockwise to raise the lift head slightly.
5. Locate the jack according to the fig. below.

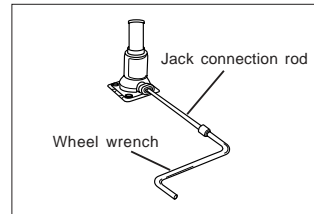
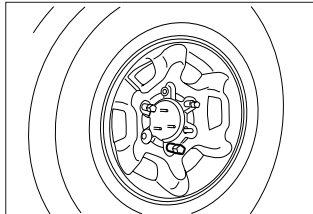
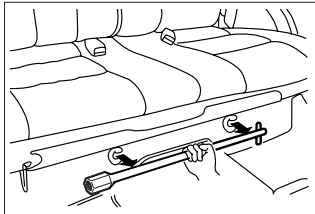

6. Place the jack vertically at the front or rear jacking location closest to the wheel you plan to change.

CAUTION
Do not attempt to raise vehicle until the jack is in the proper position, and secure both to the vehicle and the ground.

7. Jack up the vehicle by rotating the jack connection rod clockwise until the tyre is off ground about 1 inch (3cm).

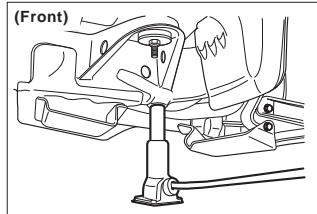

8. As the jack begins to raise the vehicle, make sure jack is properly placed so it will not slip.

NOTE
Do not raise vehicle more than is necessary to change wheel.

WARNING
Never get under car or start or run the engine while car is supported by a jack. Vehicle may slip off the jack resulting in serious injury or death.

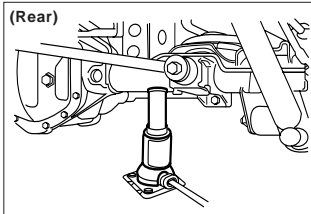

9. Remove wheel nuts completely by turning counterclockwise.
 10. Remove tyre and wheel.
 11. Mount spare tyre on the wheel hub.

CAUTION

- Never use oil or grease on wheel nuts.
- Always use the correct wheel nuts.
- Using the wheel nut wrench in the vehicle tool kit, tighten the nut down firmly.
- As soon as possible, take your car to a Ssangyong dealer or Ssangyong Authorized Service Operation and have the wheel nuts tightened according to Ssangyong specifications.
- If tighten inconnectly, the nuts could come loose.

12. Replace and lightly seat the wheel nuts by turning clockwise.
13. Turn jack connection rod counter-clockwise and lower vehicle to the ground.
14. Tighten the wheel nuts firmly to 74 ± 14 lb-ft (100 ± 20 N·m); for steel wheel, 89 ± 7 lb-ft (120 ± 10 N·m); for aluminum wheel according to sequence No. of below figure.
15. Check and adjust tyre pressure.
16. Secure the jack and tools in their proper locations.
17. Secure the flat tyre in the spare tyre well on the tailgate.

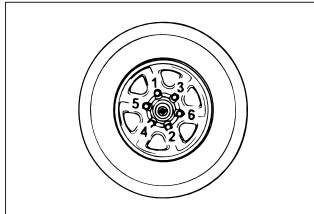

WARNING

When using the jack the vehicle could become unstable and move, damaging the vehicle or badly injuring.

- Use jack supplied at correct jacking position.
- When installing the jack for lifting the vehicle, it should be perpendicular to the ground.
- Do not go under a jacked-up vehicle.
- Do not start engine while jacked up.
- Before jacking, get all passengers out of the vehicle and clear of vehicle and other traffic.
- Use jack only for changing wheels.
- Do not jack vehicle on an inclined or slippery surface.
- Use jacking position nearest to required wheel change.
- Block wheel diagonally opposite the wheel to be changed.
- Before jacking ensure parking brake is on and the transmission is set in 1st or reverse gear (manual transmission) or P (automatic transmission).
- Do not jack the vehicle and change the wheel where traffic is close.

STARTING THE ENGINE WITH JUMPER CABLES

CAUTION

- Do not try to start vehicle by pushing or pulling it.
- This can damage catalytic converter and automatic transaxle, and may cause personal injury.

You can start a vehicle that has a discharged battery by transferring electrical power to it from a battery in another vehicle.



⚠ WARNING

*Batteries can explode.
You could be burned by battery acid.
Electrical short could injure you or
damage the vehicles.*

- *Do not expose battery to flames or sparks.*
- *Do not lean over battery while jump starting vehicle.*
- *Do not allow cable terminals to touch each other.*
- *Wear eye protection when working near any battery.*
- *Do not allow battery fluid to contact eyes, skin, fabric, or painted surfaces.*
- *Make sure battery providing jump start has the same voltage as the battery receiving the jump.*
- *Do not disconnect discharged battery from vehicle.*

(Continued)

⚠ WARNING

(Continued)

Failure to follow these precautions or the following instructions for starting an engine with jumper cables can cause battery to explode, resulting in burns from battery acid, or electrical short circuit.

This can create damage to electrical systems in both vehicles, and cause serious personal injury.

Before jump starting a battery:

1. Apply parking brake.
2. In a vehicle with automatic transmission, shift to PARK; with manual 5 speed transmission, shift to NEUTRAL.
3. Switch off all electrical accessories.

⚠ CAUTION

Turn audio system off before jump starting your vehicle. Otherwise you may damage audio system

⚠ WARNING

Always route jumper cables so they cannot catch on rotating parts in the engine compartment. Otherwise you may damage vehicle and cause serious personal injury.

6-8 IN CASE OF EMERGENCY

Attaching Jumper Cables

To jump start your battery, connect the jumper cables in the following order:

1. Connect one clamp of the first lead of the jumper cable to the positive terminal of the charged battery. (identified by a "+" sign on the battery case or terminal.)
2. Connect other end of this same jumper cable lead to the positive terminal of the discharged battery. (the "+" terminal.)
3. Connect one end of the second lead on jumper cable to the negative terminal of the charged battery. (identified by a "-" sign on the battery case or terminal.)

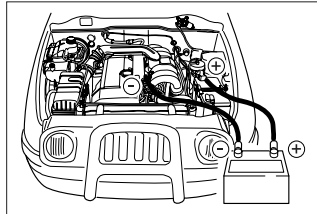

⚠ WARNING

- **Last connection to the vehicle to be charged should NOT be made to the negative ("-") battery terminal.**
- **Attach the clamp for this last connection to a steel bracket bolted to the engine block.**
- **This last connection should be as far away from the battery as possible.**
- **Connecting the jumper cable to the negative terminal of the discharged battery could result in arcing and possibly a battery explosion. Serious personal injury or vehicle damage can result.**

4. Make the last connection to a suitable ground, such as a steel bracket bolted to the engine block.
5. The engine of the vehicle providing the jump start can be allowed to run during the jump start.

Attempts to start the engine of the vehicle with the discharged battery should be made at intervals of about one minute and should not last longer than 15 seconds each.

Once the previously discharged vehicle is running:

6. Carefully disconnect the ground connection("-"). Begin with the vehicle with the discharged battery.
Leave the discharged vehicle running.
7. Disconnect the negative lead from vehicle providing the jump.
8. Disconnect the "+" lead from both batteries.
9. Operate the discharged vehicle for approximately 20 minutes. This will allow the charging system to recharge your battery.
10. If this discharge condition recurs, consult your Ssangyong dealer or an authorized Ssangyong Service Operation.

TOWING A DISABLED VEHICLE

If it is necessary to tow your vehicle, contact a Ssangyong dealer or a professional tow truck service.

Your vehicle (4 Wheel Drive Vehicles) should be towed with towing dolly under the wheels or on a flat bed.

⚠ WARNING

- Never let passengers ride in a vehicle that is being towed.
- Never tow a vehicle faster than safe or posted speeds.
- Never tow a vehicle with damaged parts that are not fully secured on the vehicle.

Failure to observe these precautions can result in personal injury.

⚠ CAUTION

To tow the vehicle with the front/rear wheels on the ground, never forget to disconnect the front/rear propeller shaft from the transfer case and axle assembly. Secure them in safe position.

⚠ CAUTION

- Never tow your vehicle from the front/rear with the rear/front wheels on the road.
- If your vehicle must be towed from the front/rear, use a towing dolly under the front wheels.

Towing your vehicle with the rear/front wheels on the road can cause severe damage to your vehicle transmission.

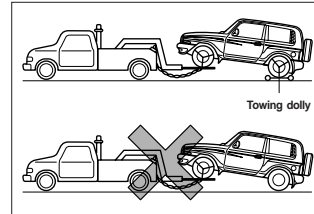
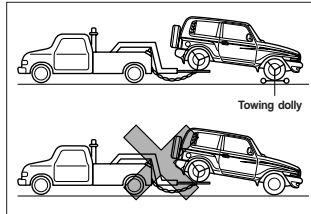
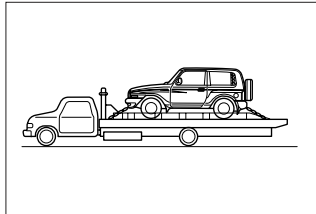

EMERGENCY TOWING

For emergency towing when a towing service is not available, your vehicle is equipped with the towing hooks under the front and rear of the vehicle for use with a tow rope.

When towing your vehicle with the tow rope:

- Secure the rope to both of the towing hooks under the front of the vehicle as tight as possible.
- Switch on the hazard warning flasher of both vehicles.
- Place the gearshift lever in neutral and release the parking brake.

- Set the ignition in the ON position to release the steering column lock and to permit the operation of brake lamps, horn and windshield wipers.
- Only the driver should be in the towed vehicle to steer it and operate the brakes.
- To prevent the entry of exhaust fumes from the towing vehicles, close the windows and place the air intake lever to the recirculation mode.
- Drive off slowly and avoid jerky movements.

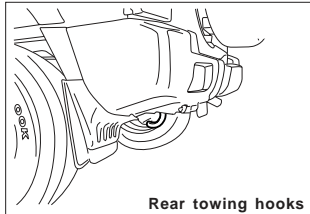
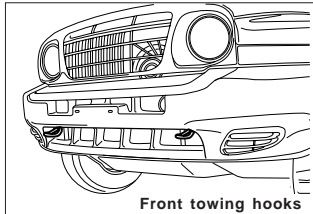
**WARNING**

When towing with a tow rope, control of towed vehicle can be lost.

- *Do not tow if the wheels, transmission, axles, steering or brakes are damaged.*
- *Do not remove key from ignition switch as this will make the vehicle unsteerable.*

CAUTION

When towing the vehicle with a tow rope, the vehicle can be damaged.

- To reduce damage,*
- *Use tow hooks only if no other towing equipment is available.*
 - *Only tow the vehicle from front.*
 - *Keep tow rope clear of bumper.*
 - *Ensure tow rope is securely fixed to tow hook, at both ends. Check by pulling on tow rope.*
 - *Towing with a tow rope could cause severe automatic transmission damage. When towing vehicle with automatic transmission, use flat bed or wheel lift equipment.*
 - *When towing another vehicle use the rear towing hook.*

Towing Tips

When towing a trailer, your vehicle will be handled differently compared with normal driving condition.

For safety, observe the following precautions:

- Practice turning, stopping, and reversing before you begin towing in traffic. Do not tow in traffic until you are confident that you can handle the vehicle and trailer safely.
- Before driving, make sure that the lighting system of the trailer works properly.
- Do not drive faster than 50km/h or legal maximum speeds, whichever is lower.
- Make sure that you have enough room when cornering and avoid sudden maneuvers.
- Avoid abrupt starts, acceleration or stops.
- Avoid sharp turns or lane changes.
- Always drive your vehicle at a moderate speed.
- Always have someone guide you when reversing.

- Allow adequate stopping distance. Stopping distance is increased when you tow a trailer.
- Slow down and shift down into a lower gear before descending steep or long downhill grades. On vehicle equipped automatic transmission, select drive range "2" or, if necessary, "1" for engine braking efforts.
- Avoid holding the brake pedal down too long or too frequently, which will cause the brakes to overheat and result in reduced brake efficiency.
- Always block the wheels on both vehicle and trailer when parking. Apply the parking brake firmly.
- Parking on a steep slope is not recommended. You really should not park your vehicle, with a trailer attached, on a hill. If something goes wrong, such as the trailer/caravan hitch becoming disengaged, people can be injured and both the vehicle and trailer can be damaged.

- If someone removing the blocks stands directly behind the trailer, he could be injured. If your brakes or the hitch slipped, the trailer could roll backward. Make sure anyone removing blocks from your wheels stands to one side.
- Take note of trailer manufacturer's instructions.

Driving on Grades

Reduce speed and shift to a lower gear before you start down a long or steep downgrade. If you don't shift down, you might have to use your brakes so much that they would get hot and no longer work well. On a long uphill grade, shift down and reduce your speed to around 40 km/h to reduce the possibility of engine and other components overheating.

Parking on Hills

You really should not park your vehicle, with a trailer attached, on a hill. If something goes wrong, your rig could start to move. People can be injured, and both your vehicle and the trailer can be damaged.

But if you ever have to park your rig on a hill, here's how to do it:

1. Apply your regular brakes, but don't shift into PARK (P) for automatic transmission yet, or into a gear for a manual transmission.
2. Have someone place chocks under the trailer wheels.
3. When the wheel chocks are in place release the regular brakes until the chocks absorb the load.
4. Reapply the regular brakes. Then apply your parking brake, and then shift to PARK (P) for automatic transmission, or First or Reverse gear for a manual transmission.
5. Release the regular brakes.

When You Are Ready to Leave After Parking on a Hill

1. Apply your regular brakes and hold the pedal down while you:
 - Start your engine
 - Shift into a gear and
 - Release the parking brake.
2. Let up on the brake pedal.
3. Drive slowly until the trailer is clear of the chocks.
4. Stop and have someone pick up and store the chocks.

Maintenance When Trailer Towing

Your vehicle will need service more often when you're pulling a trailer. See the maintenance Schedule for more on this. Things that are especially important in trailer operation are engine oil, brake pads & discs, automatic transmission fluid. Each of these is covered in this manual and the index will help you find them quickly. If you're trailering, it's a good idea to review these sections before you start your trip.

Check periodically to see that all hitch nuts and bolts are tight.



7

SERVICE AND MAINTENANCE



K140_RHD_EN_07.p65

1



2004-11-11, 14:09



ENGINE COMPARTMENT

Diesel Engine

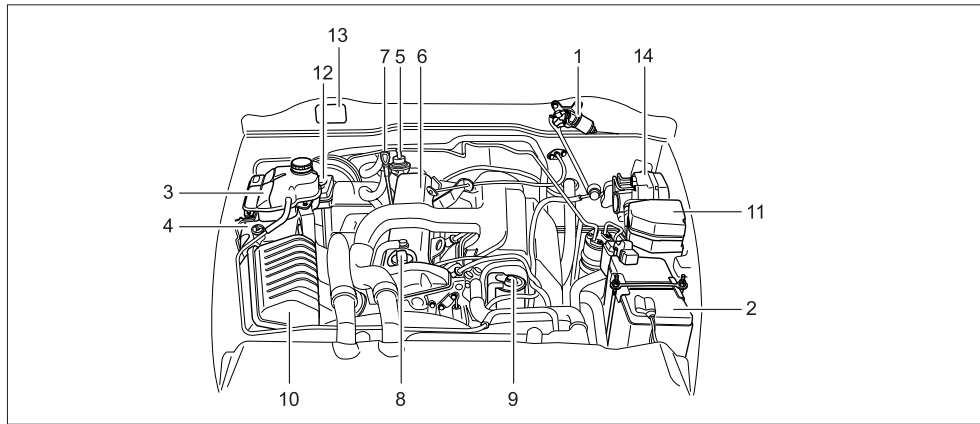

- | | | |
|---------------------------|------------------------------|--------------------|
| 1. Windshield wiper motor | 7. Engine oil level dipstick | 13. VIN plate |
| 2. Battery | 8. Engine oil filler cap | 14. ABS/ABD (TCS)* |
| 3. Coolant surge tank | 9. Fuel filter | |
| 4. Washer fluid tank | 10. Air cleaner | |
| 5. Turbo kit | 11. Fuse box | |
| 6. Engine | 12. Brake fluid tank | |

G32D Engine

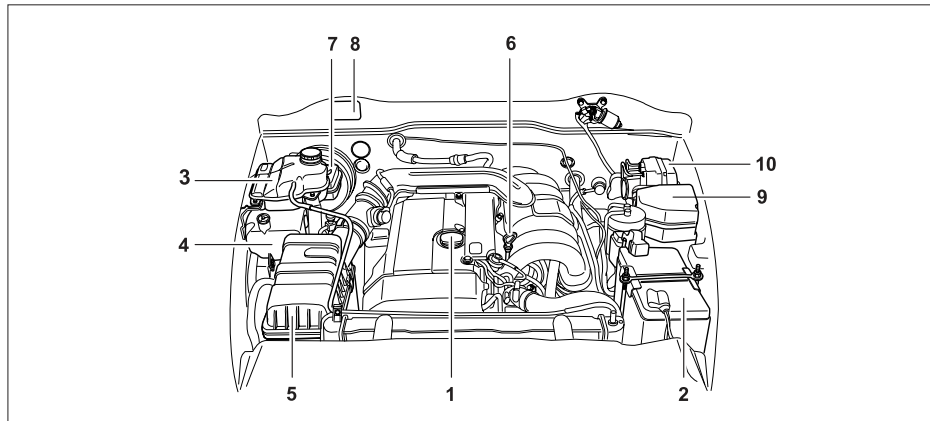

- | | | |
|--------------------------|------------------------------|--------------------|
| 1. Engine oil filler cap | 5. Air cleaner | 9. Fuse box |
| 2. Battery | 6. Engine oil level dipstick | 10. ABS/ABD (TCS)* |
| 3. Coolant surge tank | 7. Brake fluid tank | |
| 4. Washer fluid tank | 8. VIN plate | |

7-4 SERVICE AND MAINTENANCE

G23D Engine

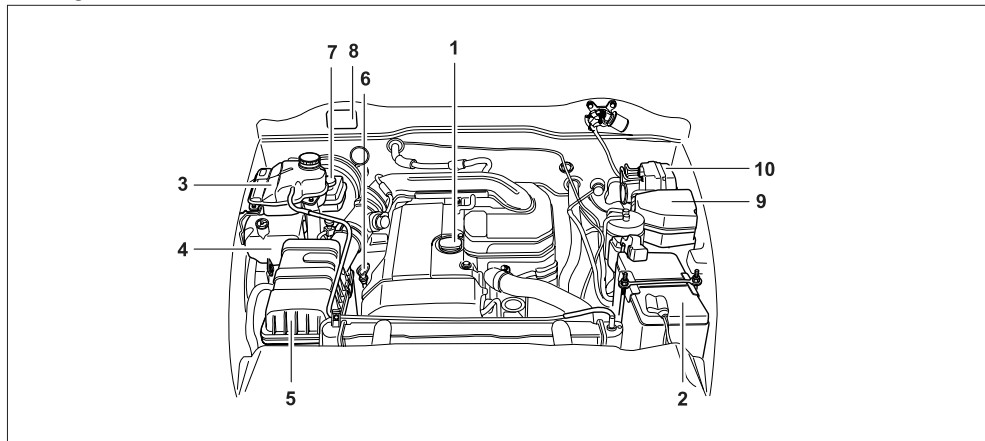

- | | | |
|--------------------------|------------------------------|--------------------|
| 1. Engine oil filler cap | 5. Air cleaner | 9. Fuse box |
| 2. Battery | 6. Engine oil level dipstick | 10. ABS/ABD (TCS)* |
| 3. Coolant surge tank | 7. Brake fluid tank | |
| 4. Washer fluid tank | 8. VIN plate | |



SERVICE PRECAUTIONS

When performing any inspection or maintenance work on your vehicle, always exercise care to reduce the risk of personal injury or damage to the vehicle.

Here are some general precautions that should be closely observed in carrying out any service operation.

- Do not work on the engine while it is hot. Always turn it off and allow it to cool.
- Never get under the vehicle while it is supported by a jack. If it is necessary to work under the vehicle, use safety stands.
- Keep smoking materials, flames, and sparks away from the battery and all fuel and fuel-related parts.
- Never connect or disconnect either the battery or any transistorized component while the ignition switch is ON.
- When connecting the battery cables, pay special attention to their polarities. Never connect a positive cable to a negative terminal or a negative cable to a positive terminal.
- Remember that the battery, ignition cables, and vehicle wiring carry high currents or voltage. Be careful not to cause a short circuit.
- When performing any checks in an enclosed space with the engine running, such as in a garage, be sure there is proper ventilation.
- Keep used oil, coolant and other fluids out of reach of children and pets.
- Empty and used oil/fluid containers must not be disposed of in the household refuse waste. Use your local authorized waste disposal facilities when disposing of them.
- If it is necessary to check beneath the engine hood with the engine running, park the vehicle on level ground, place the shift lever in NEUTRAL (manual transmission) or "P" position (automatic transmission) and apply the parking brake firmly. Unexpected and possibly sudden vehicle movement may occur if these precautions are not taken.
- To avoid the possibility of personal injury, you should always turn off the ignition switch and remove the key before working under the engine hood unless the procedure specifically requires otherwise. If it requires running the engine while working under the engine hood, do not permit any clothing, such as ties or handkerchiefs, near the engine or cooling fan. They can become entangled in moving parts and result in personal injury and damage to the vehicle. Also remove watches, bracelets, and rings for safety.

A NOTE ON SAFETY

To avoid the possibility of injury from the cooling fan, carry out all engine checks with the ignition switched off so that the fan is not operating.

The fan is controlled by ECU (electronic control unit) and consequently may start to operate unexpectedly.

When the ignition is on, it is also highly dangerous to touch live parts as the electronic ignition system has a greater current ignition power than conventional systems.

⚠ WARNING

You can injury, burn or shock.

- *Make sure engine is off.*
- *Do not touch live parts when ignition is on.*

⚠ WARNING

Keep service products away from children. If a service product has been swallowed, consult a doctor without delay.

Dispose of service product in an environmentally responsible way.

DRIVER'S CHECK LIST

The following checks are recommended before driving to maintain safe and dependable vehicle operation.

Exterior

1. Check the tyres for inflation pressure and damage.
2. Check the wheel bolts for looseness.
3. Check the operation of the lights.
4. Check for any oil, water, fuel and fluid leaks.

Within the Engine Compartment

1. Check the engine oil level.
2. Check the engine coolant level in the surge tank.
3. Check the battery condition.
4. Check the level of windshield washer solution.
5. Check the level of the brake and clutch fluid in the reservoir.
6. Check the level of the power steering fluid.

Within the Vehicle

1. Check for steering wheel play and looseness.
2. Check the parking brake lever travel.
3. Check the operation of the horn, windshield wipers and turn signals.
4. Check the operation of instruments and indicator warning lights.
5. Check level of fuel in the fuel tank against fuel gauge.
6. Check the position of the rearview mirrors.
7. Check the operation of the door locking mechanism.
8. Check the clutch pedal free play, height and function.
9. Check the brake pedal free play, height and function.

ENGINE OIL

Checking Procedure

The engine oil must be kept at the right level to help assure proper lubrication of your vehicle's engine. It is normal for an engine to use some oil. It is owner's responsibility to check the oil level at regular intervals (such as every fuel stop).

The engine oil level should be checked with the vehicle standing on level ground.

After stopping the engine, wait a few minutes before checking the level for the oil to drain back to the oil pan. If the engine is cold, the oil may take considerably longer to drain back.

To check the oil level, pull out the dipstick, wipe it clean and reinsert it as far as it will

go. Pull it out again and check that the oil level is between the lower mark (Min) and the upper mark (Max) on the oil dipstick. Also check the oil on the dipstick rod for contamination.

If the level gets to the lower point, add enough oil not to exceed the level of the upper mark.

The oil should not go above the upper mark on the dipstick. This would lead, for example, to increased oil consumption, fouling of the spark plugs and excessive formation of carbon residue.

When replenishing, use the same specification of oil as used at the last oil change.

⚠ WARNING

Prolonged and repeated contact with engine oil may cause skin disorders.

- *Avoid excessive skin contact.*
- *Wash thoroughly after contact.*

⚠ WARNING

Keep used engine oil out of reach of children.

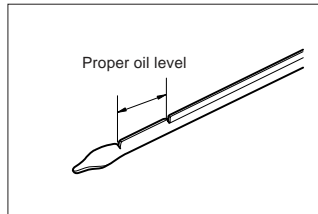

Diesel engine

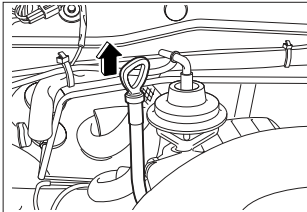

Gasoline engine

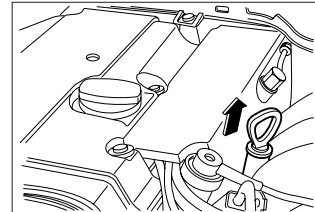

Change of Engine Oil and Oil Filter

⚠ CAUTION
Operating with insufficient or too much amount of oil can damage the engine.

- *Check engine oil regularly.*
- *Top up if required.*
- *Don't add too much oil.*

⚠ CAUTION
In order to ensure sufficient lubrication of the moving parts, select engine oil viscosity (SAE grades) according to ambient temperature.

NOTE
Damage to the engine by operating with insufficient oil invalidates the warranty.

Model	Service interval	Capacity
D29ST	Initial change: 5,000 km, Change every 10,000 km or 12 months (But, shorten the service interval under severe conditions)	7.5 ~ 9.5 L
G23D	Initial change: 10,000 km, Change every 15,000 km or 12 months (But, shorten the service interval under severe conditions)	6.0 ~ 7.5 L
G32D		6.7 ~ 8.2 L

Engine Oil and Oil Filter Change

Engine oil changes are to be carried out depending on time intervals and mileage intervals, since oil loses its lubrication properties not only through engine operation but also through ageing.

Under exceptional conditions e.g. frequent cold starts or extra urban traffic and congestion of traffic, the engine oil and engine oil filter should be changed at shorter intervals rather than the recommended maintenance schedule.

Engine oil filter elements should be replaced at the same time with engine oil.

⚠ WARNING

Used engine oil and their containers can be a hazard to health and the environment.

- *Do not dispose of used engine oil in household refuse waste.*
- *Use your local authorized waste disposal facilities when disposing of used engine oil.*

Severe Conditions

- When most trips are less than 6km.
- Operating when outside temperatures remain below freezing and when most trips are less than 16km.
- When most trips include extended idling and/or frequent low-speed operation as in stop-and-go traffic.
- When operating in dusty areas.
- Towing a trailer.

COOLANT LEVEL

The cooling system is filled with an ethylene glycol base coolant.

In the correct concentration the coolant provides excellent corrosion and freeze protection for the entire cooling and heating system and must therefore not be replaced by plain water even in summer.

The coolant level should be between "LOW" and "FULL" mark on the coolant surge tank when the engine is cool. The level rises at engine operating temperature and drops again when the engine cools down.

If the level falls below the "LOW" mark, refill the radiator with a 50/50 mix of distilled water and antifreeze specified, to provide freezing and corrosion protection.

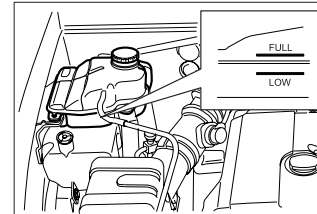

In order to protect your vehicle in extremely cold weather, use a mix 40% distilled water and 60% antifreeze specified.

Coolant Concentration

	Percentage of Antifreeze	Percentage of Water
General area	50%	50%
Extremely cold area	60%	40%

⚠ WARNING

Scalding hot coolant and steam could be blown out under pressure, which could cause serious injury. Never remove the coolant surge tank cap when the engine and radiator are hot.

⚠ WARNING

Take precautions to prevent antifreeze coming in contact with the skin or eyes.

- *If contact happens, rinse affected areas immediately with plenty of water.*
- *If irritation persists, consult doctor.*

⚠ CAUTION

The engine or cooling system could be damaged.

- *The antifreeze content of the coolant should be maintained at a minimum of 50%. The antifreeze content must not be allowed to exceed 60%.*
- *Do not use alcohol or methanol antifreeze or mix them with the specified coolant.*
- *Use only distilled water in the coolant mixture.*
- *Do not overfill the coolant.*
- *If frequent additions are required, contact Ssangyong Dealer for cooling system check.*

Change of Coolant

Model	Service interval	Capacity
D29ST	Change every 60,000 km or 3 years. And, inspect and replenish as necessary.	10.5 ~ 11L
G23D		10.5 L
G32D		11.3 L

⚠ WARNING

Steam from an overheated engine can burn you badly.

- *If steam is seen, don't go to front of vehicle. Get everyone away from the vehicle.*
- *Switch off engine.*
- *Allow engine to cool.*
- *Open engine hood when steam is no longer visible.*
- *Do not remove coolant surge tank cap until the engine and radiator are cool.*

OVERHEATING

If the engine coolant temperature gauge shows an overheating condition or you have another reason to suspect the engine may be overheating, stop and park the vehicle. The air conditioning must be off. Leave the engine idling for a few minutes and check that the cooling fan is operating.

If the fan is not operating, turn the ignition off and consult your Ssangyong Dealer immediately.

If the fan is operating and steam is not coming from the engine compartment, open the engine hood and idle the engine until it cools.

If the fan is operating but the temperature is not lowered, stop the engine and let it cool.

Then, check the coolant level. If it's low, check for leaks in the radiator hoses and connections, heater hoses and connections, radiator, and water pump.

If you find a leak or other damage, or coolant is still leaking, do not run the engine until these problems have been corrected. Consult Ssangyong Dealer immediately.

BRAKE FLUID

The fluid level in the brake fluid tank should be checked according to the "Maintenance Schedule".

Before checking the fluid level, clean the area around the tank cap thoroughly. The fluid level in the brake tank must not be higher than MAX mark or lower than MIN mark.

If the level falls below the MIN mark, add the fluid to MAX mark. Do not overfill.

Low fluid level can indicate a leak in the brake system. Have the system checked at nearest Ssangyong Dealer.

To add the brake fluid, first wipe away dirt and then unscrew the fluid tank cap. After removing the cap, top up the fluid to the MAX mark and tighten the cap securely afterwards.

Service interval	Capacity
Change every 2 years	Approx. 0.7L (Level must be maintained between MAX and MIN level.)

⚠ WARNING

The brake fluid can irritate hands and eyes.

- Do not allow brake fluid to make contact with skin or eyes.
- If contact happens, rinse affected areas immediately with plenty of water.
- If irritation persists, consult a doctor.

⚠ WARNING

Keep the brake fluid out of reach of children.

⚠ WARNING

Used brake fluid and their containers can be a hazard to health and the environment.

- Do not dispose of used brake fluid with household waste.
- Use your local authorized waste disposal facilities.
- Have the brake fluid changed by Ssangyong Dealer or Ssangyong Authorized Service Operation.

⚠ WARNING

Too much brake fluid can spill on the engine. The fluid will burn if the engine is hot enough. You or others could be burned and the vehicle could be damaged.

Do not overfill the fluid.

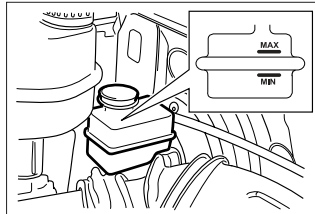

CLUTCH FLUID

CAUTION

The brake fluid systems can get contaminated and cause loss off system performance. Before removing tank cap, clean thoroughly area around cap.

CAUTION

Using of non-recommended brake fluid could cause damage to the brake system. Use only Ssangyong recommended brake fluid.

CAUTION

Brake fluid damages paintwork.
 • *If spillage onto paintwork, wash with cold water immediately.*

The clutch fluid level in the master cylinder should be checked when other underhood services are performed. The system should be checked for leakage at the same time. Before checking the fluid level, clean the area around the cap thoroughly. The level must not be higher than MAX mark or lower than MIN mark. If the level falls below the MIN mark, add the fluid to MAX mark. Do not overfill.

WARNING

If frequent top up is required, have system checked by Ssangyong Dealer or Ssangyong Authorized Service Operation.

Service interval	Capacity
Change every 2 years	Approx. 0.3L (Level must be maintained between MAX and MIN level.)

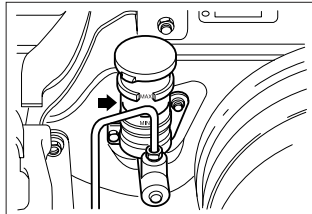

⚠ WARNING

The clutch fluid can irritate hands and eyes.

- Do not allow clutch fluid to make contact with skin or eyes.
- If contact happens, rinse affected areas immediately with plenty of water.
- If irritation persists, consult a doctor.

⚠ WARNING

Too much clutch fluid can spill on the engine. The fluid will burn if the engine is hot enough. You or others could be burned and the vehicle could be damaged.

Do not overfill the fluid.

⚠ WARNING

Keep the clutch fluid out of reach of children.

⚠ WARNING

Used clutch fluid and their containers can be a hazard to health and the environment.

- Do not dispose of used clutch fluid with household waste.
- Use your local authorized waste disposal facilities.
- Have the clutch fluid changed by Ssangyong Dealer or Ssangyong Authorized Service Operation.

⚠ CAUTION

The clutch fluid systems can get contaminated and cause loss of system performance.

Before removing reservoir cap, clean thoroughly area around cap.

⚠ CAUTION

Using of non-recommended clutch fluid could cause damage to the clutch system.

Use only Ssangyong recommended clutch fluid.

⚠ CAUTION

Clutch fluid damages paintwork.

- If spillage onto paintwork, wash with cold water immediately.

AUTOMATIC TRANSMISSION FLUID*

To ensure proper functioning, efficiency and durability of the automatic transmission, it is of the utmost importance that the fluid is always kept at the proper level.

The automatic transmission (M74LE) does not have a dipstick to check the fluid level. You may have the fluid level checked by your Ssangyong Dealer or Ssangyong Authorized Service Operation.

The only way for the fluid level to decrease is that the automatic transmission develops a leak.

If a fluid leak occurs the vehicle should be taken to your Ssangyong Dealer or Ssangyong Authorized Service Operation to be repaired as soon as possible.

Fluid should not be added to the automatic transmission without properly setting the fluid level. Overfilling the automatic transmission fluid will decrease the automatic transmission performance and could damage the unit.

Use only specified fluid as given in the lubricant chart.

The fluid and filter do not require changing. But, if the vehicle is mainly driven under any of below conditions, the fluid and filter should be changed every 60,000km (36,000 miles).

- In heavy city traffic where the outside temperature regularly reaches 32°C (90°F) or higher.
- In hilly or mountains terrain.
- When doing frequent trailer towing.
- Uses such as found in taxi, police or delivery service.

MANUAL TRANSMISSION FLUID

Check the oil level only when the engine is off, the vehicle is level and the transmission is cool enough so that you can rest your fingers on the transmission case.

Remove the filler plug to check the level.

The oil should come to the bottom edge of the filler plug hole. If level is low, add oil until it begins to run out of the filler hole. Reinstall the plug securely.

Use only the specified oil as given in the lubricant chart.

After installing the plug, visually check the transmission case for leaks or damage.

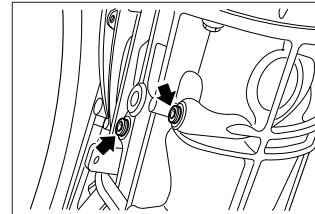

⚠ WARNING
After driving, the transmission oil temperature may be high enough to burn you. Wait until transmission oil and filler plug are cool before checking oil level.

Service interval	Change every 60,000km or 36 months. Check and replenish as necessary.	
Capacity	4WD	3.6 L
	2WD	3.4 L

POWER STEERING FLUID

Check fluid level with engine turned off. The fluid level should lie between the MIN and MAX marks on the reservoir. If it drops to or below the MIN mark, top up with the specified fluid.

Use only specified fluid as given in the lubricant chart.

The level in the reservoir should be checked in accordance with the intervals specified in this manual.

Service interval	Capacity
Check and replenish as necessary.	1.0L

⚠ WARNING
Operating the vehicle with insufficient amount of power steering fluid could cause damage to the power steering unit.

- Check level regularly.
- Top up if required.
- If frequent top up is required, have system checked by Ssangyong Dealer or Ssangyong Authorized Service Operation.



AIR CLEANER

If the vehicle is operated in very dusty or sandy areas, replace more often than at the usual recommended intervals. If it is dirty, shake the element to remove dust. Clean the inside of the air cleaner housing and cover with a damp cloth.

Clean the air cleaner element by blowing compressed air through it in the opposite direction to normal air flow.

⚠ WARNING

**Engine can be damaged.
Do not operate the vehicle without air cleaner element.**

Service Interval

Diesel Engine	For vehicles with TURBO CHARGER SYSTEM	Clear every 10,000km Replace every 30,000km
Gasoline Engine		Clear every 15,000km Replace every 60,000km

* Under severe condition, the service interval should be shorter than the usual recommended.

Diesel engine

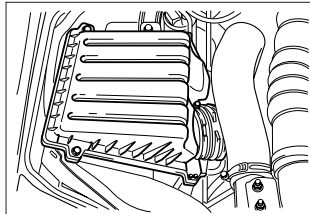

Gasoline engine

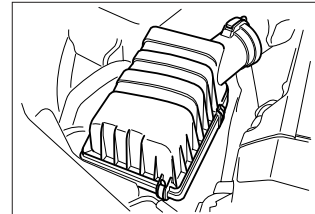

TRANSFER CASE FLUID

To ensure proper functioning, efficiency and durability of the transfer case, it is of importance that fluid is always kept at the proper level.

You may have the fluid level checked by your Ssangyong Dealer or Ssangyong Authorized Service Operation.

If the change of fluid is in need, the vehicle should be taken to your Ssangyong Dealer or Ssangyong Authorized Service Operatin.

Service Interval Specification and Capacity

Transfer case (Part-time)	Service interval	Inspect every 10,000 km Change every 60,000 km
	Specification	ATF DEXRON® III
	Capacity	1.2 L
Transfer case (TOD)	Service interval	Inspect every 10,000 km Change every 60,000 km
	Specification	ATF DEXRON® III
	Capacity	1.4 L

Part-time

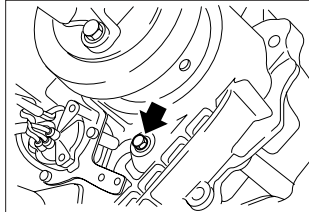

TOD

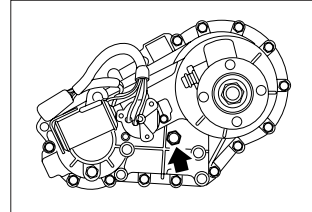

SPARK PLUGS

Spark plugs should be inspected periodically for carbon deposits. When carbon accumulates on a spark plug, a strong spark may not be produced.

If necessary, clean the electrodes with a fine wire brush and carefully scrape the carbon off the insulator with a small file. The spark plugs should be blown clean with compressed air and the upper insulator wiped clean. And adjust the spark plug gap.

Service interval
Change every 30,000 km

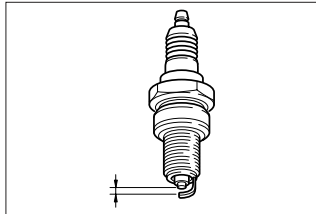

Specification	BOSCH : F8DC4
	BERU : 14F-8DU4
	CHAMPION: C11YCC
Gap	0.8 - 1.2 mm

- ⚠ CAUTION**
- *When replacing the spark plugs, disconnect the negative terminal of the battery and turn off all the switches.*
 - *It is recommended that the engine be cool or cold when changing the spark plugs (you could burn yourself).*
 - *Do not use non-recommended spark plugs.*
 - *Do not allow contaminants to enter spark plug hole.*

⚠ WARNING

Spark plugs may be very hot. Be careful not to burn yourself.

FUEL FILTER

D29ST (Diesel Engine)

If the filter is contaminated, the supplied fuel will be reduced, main components will be damaged due to entering the contaminated materials and the performance of catalytic converter will be deteriorated. Replace the fuel filter according to the specified maintenance schedule.

- Service Interval
Replace every at 40,000 km

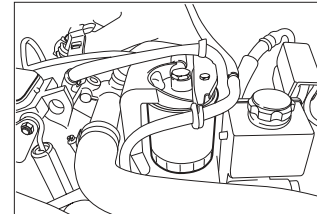

Gasoline Engine

If the filter is contaminated, the supplied fuel will be reduced, main components will be damaged due to entering the contaminated materials and the performance of catalytic converter will be deteriorated. Replace the fuel filter according to the specified maintenance schedule.

- Service Interval
Replace at every 60,000 km

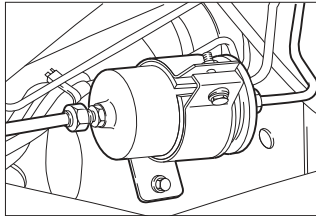

DRIVE BELT

If the belt is worn, cracked or frayed, replace it.

⚠ WARNING

The engine could abruptly start while checking the belt and cause moving parts to crush or cut. Remove key from ignition switch.

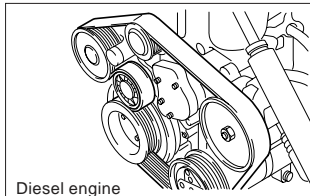

Diesel engine

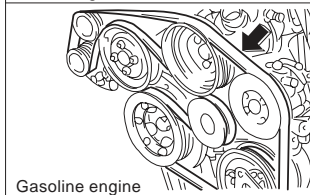

Gasoline engine

WINDSHIELD WASHER FLUID

Use the specified windshield washer solution.

⚠ WARNING

Driving without washer fluid can be dangerous. Check your washer fluid level before starting to drive.

Front

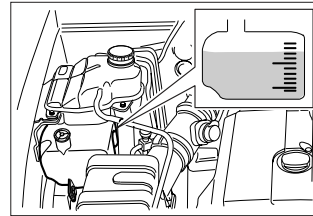

⚠ WARNING

- **Do not use radiator antifreeze in windshield washer. It can damage the washer system and paint.**
- **Do not mix water with washer fluid. Water can cause the solution to freeze and damage washer fluid tank and other parts of washer system.**
- **Fill washer fluid tank only 3/4 full when it is very cold. This allows for expansion, which could damage the tank if it is completely full.**

WINDSHIELD WIPERS

Properly functioning windshield wipers are essential for safe driving and clear vision. Check condition of wiper blades from time to time. Hardened, brittle or smearing blades must be replaced.

Since there is no way to successfully remove traces of silicone from any glass, be certain not to apply any polish containing silicone to the windshield of your vehicle since this will result in streaks which impair vision.

Contamination of either the window or the wiper blades with foreign matter can reduce the effectiveness of the windshield wipers.

If the blades are not wiping properly, clean both the window and the blades with a good cleaner or mild detergent, and rinse thoroughly with clear water. Repeat if necessary.

To replace the wiper blade, press the retaining clip and pull the wiper blade off the arm. Simply push the new wiper blade onto the arm.

⚠ WARNING

Solvents, gasoline, kerosene and paint thinner can damage wiper blades. Keep them away from wiper blades.

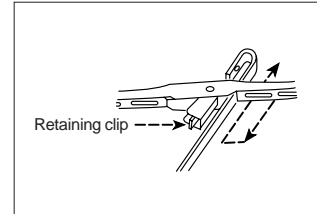
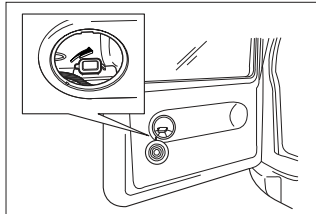

Rear



BATTERY MAINTENANCE

Your vehicle is fitted with a maintenance free (MF) battery without seal plugs. It needs no periodic maintenance.

The hydrometer (test indicator) in the top of the battery provides information for testing purposes only.

GREEN DOT	'BLACK' DARK	TRANSPARENCY
		
Normal	Discharged (→) Charging	If the engine is not started, replace the battery and check the charging system

BUILT-IN HYDROMETER

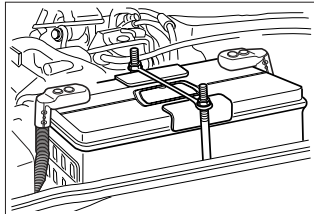

Check the battery terminals for corrosion (a white or bluish powder). To remove it, cover the terminals with a solution of baking soda and water. It will bubble up and turn brown. When this stops, wash it off with plain water. Dry off the battery with a cloth or paper towel.

Coat the terminals with petroleum jelly to help prevent future corrosion. If the terminals are severely corroded, clean them with baking soda and water.

Use a wrench to loosen and remove the cables from the terminals. Always disconnect the negative (-) cable first and reconnect it last. Clean the battery terminals with a terminal cleaning tool or wire brush. Reconnect and tighten the cable, then coat the terminals with petroleum jelly.

For best battery service, do the following.

1. Keep battery securely mounted.
2. Keep battery top clean and dry.
3. Keep terminals and connections clean, tight and coated with petroleum jelly or terminal grease.
4. Rinse off any spilled electrolyte immediately with a solution of water and baking soda.
5. If vehicle is not being used for an extended time, disconnect the cable from the negative (-) terminal of the battery to prevent discharge and charge battery every six weeks.

⚠ WARNING

The battery have acid that can burn you and gas that can explode.

You can badly hurt if you are not careful.

- ***Keep naked flames, sparks and smoking items away from battery.***
- ***Do not let any parts of body, clothes or paintwork contact the sulfuric acid.***

⚠ WARNING
Used batteries can be a hazard to health and the environment.

- *Do not dispose of used batteries with household waste.*
- *Use your local authorized waste disposal facilities.*

⚠ CAUTION
The polarity of battery, i.e. the connections for positive and negative cables, must not be interchanged.

BRAKE PEDAL

Checking Pedal Free Play

Turn off the engine and depress the brake pedal several times to deplete the vacuum in the brake system. Gently depress the brake pedal by hand and measure the distance it moves until slight resistance is felt. If the free play is more or less than specified, have the brakes adjusted by a Ssangyong Dealer or Ssangyong Authorized Service Operation.

Brake pedal free play	1 ~ 4mm
-----------------------	---------

CLUTCH PEDAL

Checking Pedal Free Play

Depress the pedal by hand until clutch resistance is felt; ensure free play is within specification. If the free play is more or less than specified, have the clutch or linkage adjusted by Ssangyong Dealer or Ssangyong Authorized Service Operation.

Clutch pedal free play	5 ~ 15mm
------------------------	----------

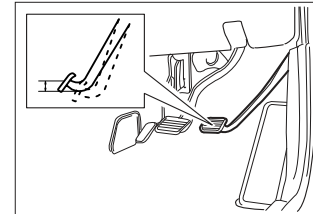
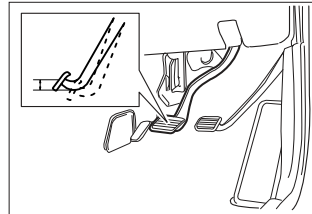
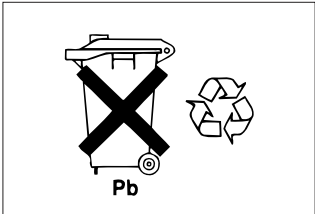

PARKING BRAKE

Check the stroke of the parking brake by counting the number of notch clicks heard while fully applying it from the released position.

Also, the parking brake alone should securely hold the vehicle on a fairly steep grade. If the number of clicks is more or less than specified, have the parking brake adjusted by a Ssangyong Dealer or Ssangyong Authorized Service Operation.

Stroke	4-7 notches at a force of 20kg
--------	--------------------------------

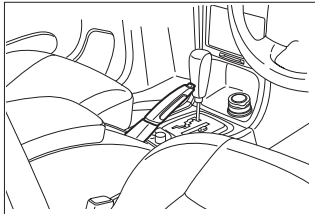
**CATALYTIC CONVERTER***

The catalytic converter is located between exhaust manifold and center muffler. The catalytic converter consists of monoliths with honeycomb shaped structure of ceramic material which are elastically mounted in a mat.

This precious metal coating on the monoliths accelerate the reduction and/or oxidation of toxic components.

On vehicles with a catalytic converter for unleaded fuel, lead fuel will damage the catalytic converter and parts of the electronic system, thereby rendering them inoperative.

Damage to the Catalytic Converter or the Vehicle May Result If the Following Points Are Not Observed :

- Consult a Ssangyong Dealer or Ssangyong Authorized Service Operation as Quickly as possible in the event of misfiring, irregular engine running following a cold start, a significant loss of engine power or other unusual malfunctions which may indicate a fault in the ignition system.
If necessary, driving may be continued for a short time at a low speed and with low engine revolutions.

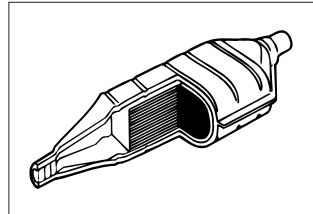

WHEELS AND TYRES

You Should Therefore Avoid :

- Frequent repeated cold starts.
- Actuation of the starter for an unnecessarily long time during starting (fuel is injected during the starting procedure).
- Allowing the tank to become empty (an irregular fuel supply leads to overheating)
- Starting the engine by pushing or towing (unburned fuel may enter the catalytic converter) : use jump leads.

Have all maintenance work carried out by a Ssangyong Dealer or Ssangyong Authorized Service Operation. You can then be certain that all components of the vehicle's electrical, injection and ignition system will be operating correctly, that your vehicle has a low level of pollutant emission and that the catalytic converter system will have a long life.

Factory-fitted tyres are matched to the chassis and offer optimum driving, comfort and safety. Consult your Ssangyong Dealer or Ssangyong Authorized Service Operation before changing over to different tyres or rims and obtain their advice as regards technical possibilities. Use of unsuitable tyres or rims may lead to accidents.

Tyre Inflation Pressure

Maintaining the specified tyre pressure is essential for driver comfort, driving safety and long tyre life. Check the tyre pressure, including the spare wheel, at least every 14 days and prior to any long journey. The tyres should be checked in a cold condition using an accurate tyre pressure gauge.

Increased pressure resulting from tyre warm-up must not be reduced, otherwise the pressure may drop below the permissible minimum.

Securely retighten valve caps after checking pressure.

Incorrect inflation pressures will increase tyre wear and will impair safety, vehicle handling, comfort and fuel economy.

If the pressure is too low, this can result in considerable tyre warm-up and internal damage, leading to tread separation and even to tyre blowout at high speeds.

Hidden tyre damage is not eliminated by subsequently adjusting the inflation pressure.

TYRE	kPa(psi)	
	FRONT	REAR
P235/70R16*	207 (30)	207 (30)
P235/75R15	207 (30)	207 (30)
P255/65R16*	207 (30)	207 (30)

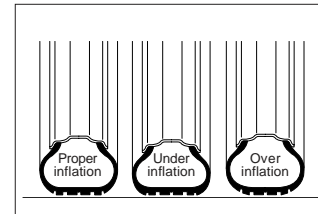

⚠ WARNING

To reduce the risk of loss of vehicle control and personal injury;

- **Property inflate tyres.**
- **Do not overload vehicle.**

Tyre Condition, Rim Condition

Driving over sharp edges can lead to hidden tyre damage and rim damage which is only noticed later on : there is a danger of tyre blowout.

Drive over edges slowly and at right angle if possible. When parking, ensure that the tyres are not pressed against the edge of the curb.

Check tyres regularly for damage (foreign bodies, punctures, cuts, cracks, bulges in side walls). A damaged tyre could burst. Check rims for damage. In the event of damage or abnormal wear, consult a Ssangyong Dealer or Ssangyong Authorized Service Operation.

Abnormal wear is usually caused by incorrect tyre pressure, lack of regular rotation, improper wheel alignment, out-of-balance tyres, severe braking or poor driving habit.

Check tread depth regularly. To help you detect when the tyres should be replaced, the tyres on your vehicle have built-in tread wear indicators that appear between the tread grooves when the tread is 1.6mm or less. The tyres should be replaced when the tread worn down as far as one of the wear indicators. The wear indicator's position is indicated by markings on the tyre side wall. For safety reasons, it is recommended that the tyres be replaced when their tread depth has worn down to 2-3mm.

When replacing the tyres, the radial tyres should be fitted in pairs, or for preference in sets.

tread wear indicator



Make sure that both tyres on an axle are the same size, the same design, and the same make and have the same tread pattern.

⚠ WARNING

Mixing tyres could cause you to lose control while driving.

Using tyres of different sizes may also cause damage to the vehicle.

Be sure to use the same size and type tyres on all wheels.

⚠ WARNING

Driving on worn, old or damaged tyres is very dangerous and can cause accidents.

Replace tyres if ;

- **The tread wear indicator appears, or tyres have been damaged.**

⚠ WARNING

Dispose of worn tyres in accordance with local environmental regulations.



Tyre Rotation

Front and rear tyres perform different jobs and can wear differently depending on the tyres of road driven, driving habit, etc. To avoid uneven wear of tyres and to prolong tyre life, inspect and rotate your tyres every 5,000km. After rotating, adjust the tyre pressure and be sure to check wheel bolts tightness.

Winter Tyres

If winter tyres are used they must be fitted to all 4 wheels. Do not exceed the maximum speed specified by the tyre manufacturer. When using winter tyres, the tyre pressures supplied by the tyre manufacturer must be adhered to.

WARNING

Using of winter tyres could adversely affect safety and handling of the vehicle.

- Use equivalent size and type to vehicle's standard tyres.
- Change over from winter to summer tyres as soon as road condition allow.

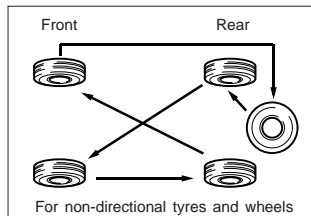
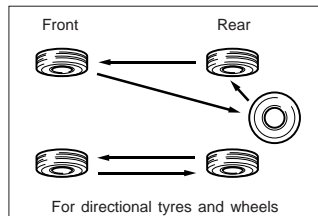

WARNING

Using of tyre chains could adversely affect safety and handling of the vehicle. If necessary, consult your Ssangyong Dealer.



ELECTRICAL SYSTEM**Ignition System**

Electronic ignition systems have a greater ignition power than conventional systems. It is thus highly dangerous to touch live parts.

Fuse

For fuse replacement, withdraw the cover and extract blown fuse.

A defective fuse can be recognized by its melted wire. A new fuse should only be installed after the cause of the trouble has been located and eliminated.

Only fuses of the specified rating should be installed. The rating is given on all fuses.

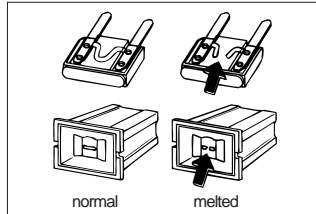

Rating	Color
7.5A	Brown
10A	Red
15A	Blue
20A	Yellow

⚠ WARNING

The use of different types or different rating fuses could cause damage to the electrical system and even start a fire.

- Always replace fuse with one with the same rating.
- Never use anything else but a fuse.
- Do not use anything metal to remove fuse.

NOTE

Five pieces of spare fuse for 7.5A, 10A, 15A, 20A, 25A are located on the inside of fuse & relay box in the engine compartment respectively.

Four pieces of spare fuse for 7.5A, 10A, 15A, 20A are located on the inside of fuse in the interior respectively.

FUSE BOX

- 1. The fuse box is located below the driver's side of dashboard under a cover.
- 2. Another fuse box is next to the brake fluid tank in the engine compartment.

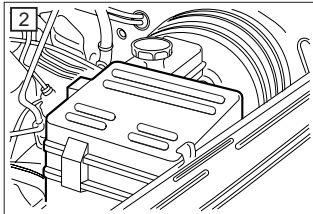
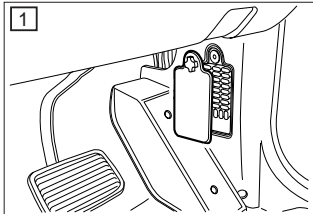

1. FUSE BOX IN THE INTERIOR

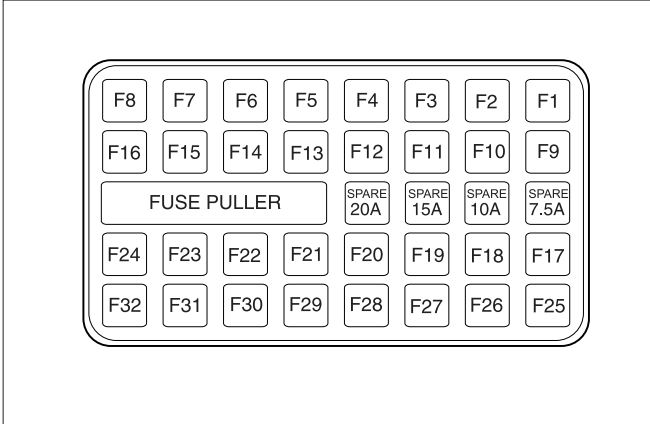

7-30 SERVICE AND MAINTENANCE

F1	Interior Lamp	15A	F12	Head lamps	7.5A	F23	T.O.D (Torque On Demand) TCU (Trasmission Control Unit)	7.5A
F2	Harzard Lamp	15A	F13	-	15A	F24	Over Voltage Protection Relay	10A
F3	Audio system	15A	F14	Audio, Outside mirrors	15A	F25	Cooling Fan, Charging	7.5A
F4	FATC (Full Automatic Temperature Control), STICS (Super Time and alarm Integrated Control System), REKES (Remote Keyless Entry System), CLOCK	10A	F15	Cigar lighter	15A	F26	Turn Signal Lamps	10A
F5	Power Window	30A	F16	Key & Shift Lock Unit	7.5A			
F6	OBD II (On Board Diagnostic Stage II), Seat Belt	7.5A	F17	T.O.D (Torque On Demand)	20A	F27	Shift Lock Control System, Backup Lamps	7.5A
F7	-	-	F18	Stop Lamps	20A	F28	Speed Meter	10A
F8	Starting	15A	F19	A.B.D	10A	F29	A.B.S., A.B.D	15A
F9	Front Wiper & Washer	15A	F20	Seat Warmer	20A	F30	Inside Mirror, Auto Cruise Control System, Cluster	7.5A
F10	Rear Wiper	10A	F21	Door Lock System	10A	F31	Air Bag	10A
F11	Airconditioning system, STICS (Super Time and alarm Integrated Control System) DEFOGGER	7.5A	F22	Fuel Pump	15A	F32	Daytime Running Light, Seat Warmer	7.5A



2. ENGINE COMPARTMENT FUSE AND RELAY BOX

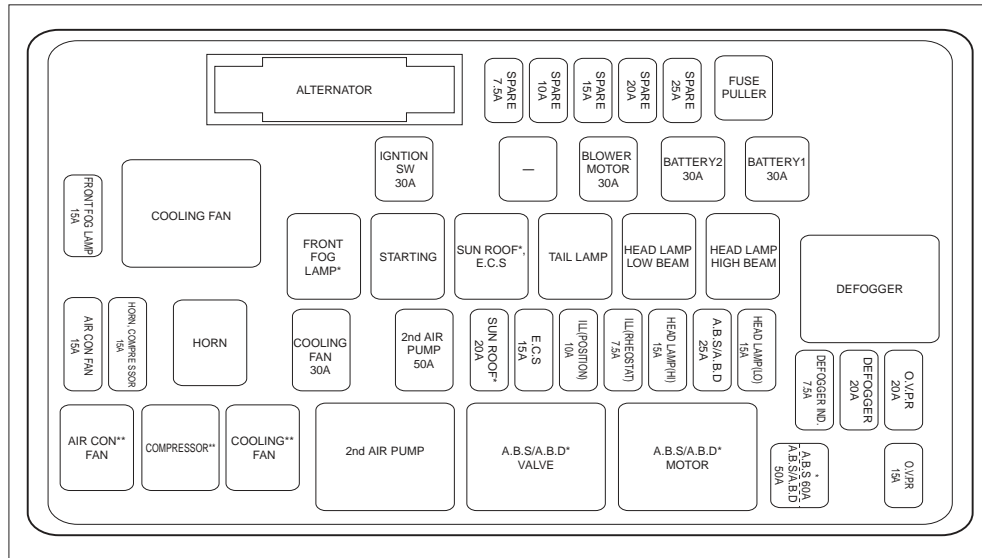

BULB SPECIFICATION

Bulbs		Wattages x Numbers	Remarks
Front	Head Lamp (high/low)		55W/60W x 2 Halogen bulb
	Front Combination Lamp	Turn Signal Lamp	21W x 2 Amber color
		Position Lamp	10W x 2
	Front Fog Lamp*		55W x 2 Halogen bulb
	Side Repeater Lamp		5W x 2
Rear	Rear Combination Lamp	Brake/Tail Lamp	21W /5W x 2
		Turn Signal Lamp	21W x 2 Amber color
		Reverse Lamp	21W x 2
		Rear Fog Lamp*	21W x 2
	License Plate Lamp		5W x 2
	High Mounted Stop Lamp*		21W x 1
Interior	Front Room Lamp		8W x 2
	Rear Room Lamp		10W x 1
	Luggage Room Lamp		8W x 1
	Door Courtesy Lamp		5W x 2

Head lamp aiming is a safety item and should therefore be carried out only by a Ssangyong Authorized Service Station which will have special equipment and the necessary expertise.

⚠ WARNING

Halogen bulbs contain pressurized gas.

Take special care when handling and disposing of halogen bulbs.

- **Wear eye protection when working with bulbs.**
- **Protect the bulb from abrasions and scratches.**
- **When the bulb is illuminated and not in a sealed installation, protect the bulb from contact with liquids.**
- **Only illuminate the bulb when it is installed in a lamp.**
- **Replace a cracked or damaged headlamp.**
- **When replacing halogen bulbs, DO NOT touch the glass part with bare fingers.**
- **Keep the bulbs away from children.**
- **Dispose of used bulbs with care. Otherwise the bulbs can explode.**

HEADLAMPS

Bulb Replacement:

1. Open the hood.
2. Disconnect the wiring harness connector ① from the rear of the bulb by pressing the upper part of the wiring harness connector.
3. Rotate the headlamp cap counterclockwise.
4. Remove the headlamp cap.
5. Remove the bulb ③.
6. Install the proper replacement headlamp bulb.
7. Reinstall the headlamp cap.
8. Reconnect the wiring harness connector.

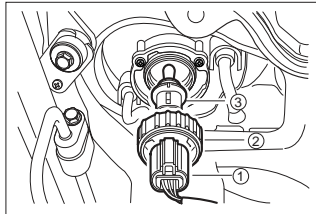
**CAUTION**

Greasy fingers will cause stains, resulting in a dull light.

- **Do not touch halogen bulbs with bare hands.**
- **Clean with a clean non fluffy cloth using alcohol or white spirits.**

FRONT COMBINATION LAMPS (TURN SIGNAL LAMPS AND POSITION LAMPS)

Bulb Replacement:

1. Remove the two screws and the two nuts.
2. Remove the lamp assembly.
3. Rotate the bulb holder counterclockwise.
4. Pull the bulb holder out of the lamp housing.
5. Press the bulb inward and rotate it counterclockwise to remove it from the bulb holder.

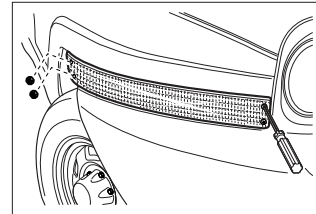

FRONT FOG LAMPS

6. Install a new bulb into the holder by pressing it in and rotating it clockwise.
7. Install the holder into the lamp housing by rotating it clockwise.
8. Reinstall the lamp assembly using the original screw and nut. Tighten securely.

Bulb Replacement:

1. Rotate the plastic cap counterclockwise and remove it.
2. Release the spring that retains the bulb.
3. Remove the bulb unit from the housing.
4. Disconnect the bulb unit from the wiring harness.
5. Replace the bulb unit.
6. Reconnect the new bulb unit to the wiring harness.
7. Make sure the recesses on the bulb holder engage correctly in the lugs of housing.

8. Reinstall the bulb retention spring.
9. Replace the plastic cap.

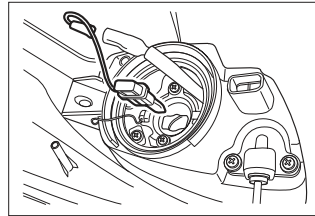
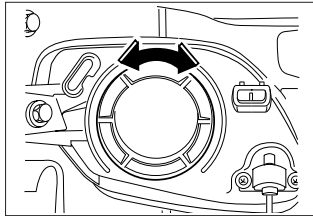
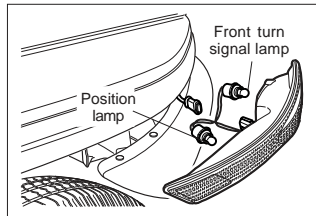

SIDE REPEATER LAMPS**Bulb Replacement:**

1. Remove the lamp assembly with a flat-blade screwdriver by pushing the retainers spring of the lamp assembly.
2. Rotate the bulb holder counterclockwise.
3. Remove the bulb from the lamp housing by pulling the bulb straight out of the holder.
4. Insert the proper replacement bulb in the bulb holder by pushing in.
5. Install the bulb holder by rotating it clockwise.
6. Push the lamp assembly into its original position.

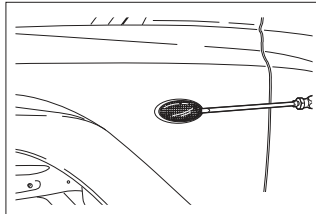
**REAR COMBINATION LAMPS (BRAKE, REAR TURN SIGNAL, REVERSE, AND REAR FOG* LAMPS)****Bulb Replacement:**

1. Open the tailgate.
2. Remove the two screws and the lamp assembly.
3. Disconnect the wiring harness connector from the rear of the lamp assembly.
4. Rotate the bulb holder counterclockwise.
5. Pull the bulb holder out of the lamp housing.
6. Press the bulb inward and rotate it counter clockwise to remove it from the bulb holder.

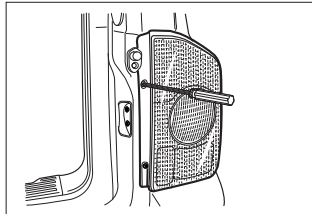

7. Install a new bulb into the holder by pressing it in and rotating it clockwise.
8. Install the bulb holder into the lamp housing by rotating it clockwise.
9. Reconnect the wiring harness connector.
10. Re install the lamp assembly using the original screw and nut, tighten securely.
11. Close the tailgate.

* Rear fog lamp: Mandatory where required by regulation

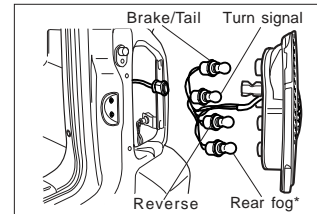

LICENSE PLATE LAMPS

Bulb Replacement:

1. Remove the two screws and the lamp assembly.
2. To remove the bulb holder from the lamp housing, rotate the bulb holder counterclockwise.
3. Pull the bulb holder out of the lamp housing.
4. Press the bulb inward and rotate it counter clockwise to remove it from the bulb holder.
5. Install a new bulb into the holder by pressing it in and rotating it clockwise.
6. Install the bulb holder into the lamp housing by rotating the bulb holder clockwise.
7. Replace the lamp assembly.

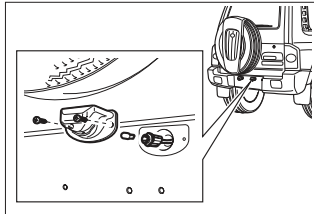
**HIGH-MOUNTED STOP LAMP (FOR VEHICLES WITH METAL ROOF)**

Bulb Replacement:

1. Open the tailgate.
2. Remove the two screws and the lamp cover.
3. Press the bulb inward and rotate it counterclockwise or clockwise to remove it from the bulb holder.
4. Replace the bulb.
5. Replace the lamp cover.
6. Close the tailgate.

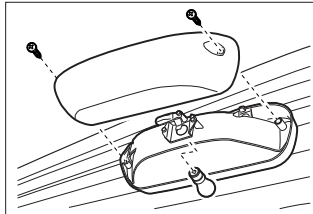
**HIGH-MOUNTED STOP LAMP (FOR VEHICLES WITH CANVAS ROOF)**

Bulb Replacement:

1. Remove the two screws and the lamp assembly.
2. Rotate the bulb holder counterclockwise.
3. Pull the bulb holder out of the lamp housing.
4. Press the bulb inward and rotate it counterclockwise to remove it from the bulb holder.
5. Install a new bulb into the holder by pressing it in and rotating it clockwise.
6. Install the bulb holder into the lamp housing by rotating it clockwise.
7. Replace the lamp assembly.

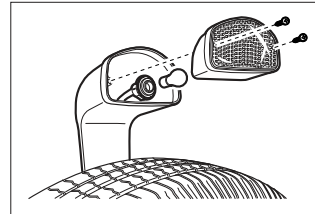

FRONT ROOM LAMP

Bulb Replacement:

⚠ WARNING
Disconnect the negative battery cable before replacing the lamp. The wire may be live.
Touching a live wire can cause an electrical shock, possibly resulting in personal injury.

1. Use a flat-blade screwdriver to pry the lamp lens away from the headliner.
2. Press the bulb toward the spring clip.
3. Remove the bulb.
4. Replace the bulb.
5. Reinstall the lamp lens.

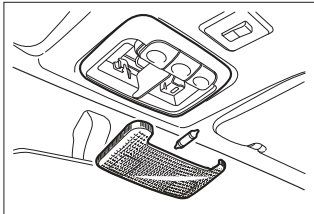

REAR ROOM LAMP

Bulb Replacement:

1. Use a flat-blade screwdriver to pry the lamp lens away from the headliner.
2. Press the bulb toward the spring clip.
3. Remove the bulb.
4. Replace the bulb.
5. Reinstall the lamp lens.

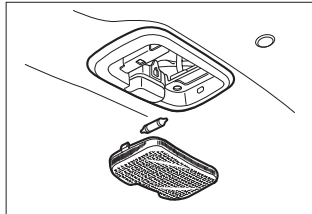

LUGGAGE ROOM LAMP

Bulb Replacement:

1. Use a flat screwdriver to pry the lamp assembly from the interior panel.
2. Press the bulb toward the spring clip.
3. Remove the bulb.
4. Replace the bulb.
5. Reinstall the lamp assembly.

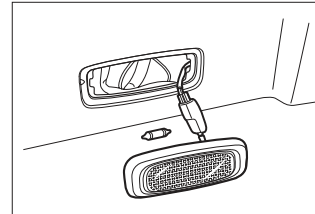

DOOR COURTESY LAMP

Bulb Replacement:

1. Use a flat screwdriver to pry the lamp assembly from the door interior panel.
2. Rotate the bulb holder counter clockwise.
3. Remove the bulb from the lamp housing by pulling the bulb straight out of the holder.
4. Insert the proper replacement bulb in the bulb holder by pushing in.
5. Install the bulb holder by rotating it clockwise.
6. Push the lamp assembly into its original position.

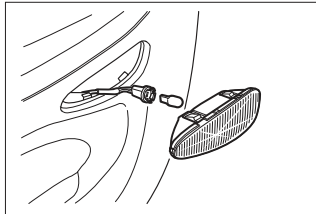

SCHEDULED MAINTENANCE SERVICES (DIESEL ENGINE)

Maintenance service and record retention are the owner's responsibility. You should retain evidence that proper maintenance has been performed on your vehicle in accordance with the scheduled maintenance service chart.

MAINTENANCE INTERVAL MAINTENANCE ITEM	Kilometers (miles) or time in months, whichever comes first											
	x1,000 km	1	10	20	30	40	50	60	70	80	90	100
	x1,000 miles	0.6	6	12	18	24	30	36	42	48	54	60
Months	-	6	12	18	24	30	36	42	48	54	60	60

ENGINE CONTROL SYSTEM

Drive belt	I	I	I	I	I	I	I	I	I	I	I	I	I
* Engine oil & filter (1)* (3)* (4)*	Initial change: 5,000 km, then change every 10,000 km												
Cooling system hose & connections	I	I	I	I	I	I	I	I	I	I	I	I	I
Engine coolant (3)* (4)*	I	I	I	I	I	I	R	I	I	I	I	R ⁽¹²⁰⁾ I ⁽¹⁰⁰⁾	I
Fuel filter	I	I	I	I	R	I	I	I	R	I	I	I	I
Fuel line & connections	I	I	I	I	I	I	I	I	I	I	I	I	I
Air cleaner (2)*	-	I	I	R*	I	I	R*	I	I	R*	I	I	I
Injection timing (See NOTE1)	-	I	I	I	I	I	I	I	I	I	I	I	I

NOTE 1: Adjust as required ; - When excessive smoke is visible (black or white) - Poor performance/economy

Chart Symbols:

I - Inspect these items and their related parts. If necessary, correct, clean, replenish, adjust or replace.

R - Replace or change.

* - mileage (km) intervals only

(1)* If vehicle is operated under severe condition: short distance driving, extensive idling or driving in dusty condition. Shorten the service interval.
Inspect the engine oil at any time, occasionally, if necessary refill the engine oil.

(2)* If vehicle is operated under severe condition, driving in dusty condition or sandy condition, frequently inspect the air cleaner, if necessary, change the air cleaner.

(3)* More frequent maintenance is required if under dusty driving condition.

(4)* Refer to "Recommended fluids, coolant and lubricants".

* Water separator: When replace the engine oil, also drain the water from water separator.

7-40 SERVICE AND MAINTENANCE

MAINTENANCE INTERVAL \ MAINTENANCE ITEM	Kilometers (miles) or time in months, whichever comes first											
	x1,000 km	1	10	20	30	40	50	60	70	80	90	100
	x1,000 miles	0.6	6	12	18	24	30	36	42	48	54	60
	Months	-	6	12	18	24	30	36	42	48	54	60

CHASSIS AND BODY

Exhaust pipes & mountings	-	I	I	I	I	I	I	I	I	I	I	I
Brake / Clutch fluid (3)*	I	I	I	I	I	R*	I	I	I	R*	I	I
Parking brake / Brake pads (Front & Rear) (4)*	-	I	I	I	I	I	I	I	I	I	I	I
Brake line & connections (including booster)	I	I	I	I	I	I	I	I	I	I	I	I
Manual transmission oil (5)*	-	I	I	I	I	I	I	R*	I	I	I	I ⁽¹⁰⁰⁾ R*(120)
Clutch & brake pedal free play	-	I	I	I	I	I	I	I	I	I	I	I
Front & Rear differential fluid (3)*	-	I	I	I	R*	I	I	R*	I	I	R*	I
Transfer case fluid (3)*	-	I	I	I	I	I	I	R*	I	I	I	I ⁽¹⁰⁰⁾ R*(120)
Automatic transmission fluid (6)*	-	I	I	I	I	I	I	R*	I	I	I	I

Chart Symbols:

I - Inspect these items and their related parts. If necessary, correct, clean, replenish, adjust or replace.

R - Replace or change.

* - mileage (km) intervals only

(3)* Refer to "Recommended fluids and lubricants".

(4)* More frequent maintenance is required if the vehicle is operated under any of the following conditions:

- Short distance driving
- Extensive idling
- Extremely dusty conditions

(5)* Inspect manual transmission fluid every 10,000 km (Inspect the leak of fluid at any time, occasionally), then change every 60,000 km

(6)* Change automatic transmission fluid and filter every 60,000 km if the vehicle is mainly driven under severe conditions.

(Inspect the leak of fluid at any time, occasionally)

- In heavy city traffic where the outside temperature regularly reaches 32°C (90°F) or higher, or
- In hilly or mountainous terrain, or
- When doing frequent trailer towing, or
- Uses such as found in taxi, police or delivery service.

SERVICE AND MAINTENANCE 7-41

MAINTENANCE INTERVAL \ MAINTENANCE ITEM	Kilometers (miles) or time in months, whichever comes first											
	x1,000 km	1	10	20	30	40	50	60	70	80	90	100
	x1,000 miles	0.6	6	12	18	24	30	36	42	48	54	60
	Months	-	6	12	18	24	30	36	42	48	54	60

Chassis & underbody bolts & nuts tight / Secure (6)*	I	I	I	I	I	I	I	I	I	I	I	I
Tyre condition & inflation pressure	I	I	I	I	I	I	I	I	I	I	I	I
Wheel alignment (7)*	Inspect when abnormal condition is noted											
Steering wheel & linkage	-	I	I	I	I	I	I	I	I	I	I	I
Power steering fluid & lines (3)*	-	I	I	I	I	I	I	I	I	I	I	I
Drive shaft boots (8)*	I	I	I	I	I	I	I	I	I	I	I	I
Seat belts, buckles & anchors	I	I	I	I	I	I	I	I	I	I	I	I
Lubricate locks, hinges & bonnet latch	I	I	I	I	I	I	I	I	I	I	I	I
Wheel bearing grease	-	-	I	-	I	-	I	-	I	-	I	-
Propeller shaft grease - Front / Rear (9)*	-	I	I	I	I	I	I	I	I	I	I	I

Chart Symbols:

I - Inspect these items and their related parts. If necessary, correct, clean, replenish, adjust or replace.

R - Replace or change.

(3)* Refer to "Recommended fluids and lubricants".

(6)* After completion of off-road operation, the underbody of the vehicle should be thoroughly inspected. Examine threaded fasteners for looseness.

(7)* If necessary, rotate and balance wheels.

(8)* After completion of off-road operation, the drive shaft boots should be inspected.

(9)* Inspect propeller shaft grease every 5,000 km or 3 months if the vehicle is mainly driven under severe condition.

- In off-road or dusty road, or

- In heavy city traffic where the outside temperature regularly reaches 32°C (90°F) or higher, or

- In hilly or mountainous terrain.

SCHEDULED MAINTENANCE SERVICES (GASOLINE ENGINE)

Maintenance service and record retention are the owner's responsibility. You should retain evidence that proper maintenance has been performed on your vehicle in accordance with the scheduled maintenance service chart.

MAINTENANCE ITEM	MAINTENANCE INTERVAL	Kilometers (miles) or time in months, whichever comes first									
		x1,000 km	1	15	30	45	60	75	90	105	120
		x1,000 miles	0.6	10	20	30	40	50	60	70	80
		Months	-	12	24	36	48	60	72	84	96

ENGINE CONTROL SYSTEM

Drive belt		I	I	I	I	I	I	I	I	I
Engine oil & engine oil filter	(1) (3)	R	R	R	R	R	R	R	R	R
Cooling system hose & connections		I	I	I	I	I	I	I	I	I
Engine coolant	(3)	I	I	I	R	I	I	R	I	I
Fuel filter	(2)	-	-	-	-	R	-	-	-	R
Fuel line & connections		I	I	I	I	I	I	I	I	I
Air cleaner	(2)	-	I	I	I	R*	I	I	I	R*
Ignition timing		-	I	I	I	I	I	I	I	I
Spark plugs		-	-	R	-	R	-	R	-	R
Charcoal canister & vapor lines		-	-	-	I	-	-	I	-	-

Chart Symbols:

I - Inspect these items and their related parts. If necessary, correct, clean, replenish, adjust or replace.

R - Replace or change.

* - mileage (km) intervals only

(1) If vehicle is operated under severe condition : short distance driving, extensive idling or driving in dusty condition, change engine oil and filter every 7,500km or 6months, whichever comes first.

(2) More frequent maintenance is required if under dusty driving condition.

(3) Refer to "Recommended fluids and lubricants".

MAINTENANCE INTERVAL MAINTENANCE ITEM	Kilometers (miles) or time in months, whichever comes first									
	x1,000 km	1	15	30	45	60	75	90	105	120
	x1,000 miles	0.6	10	20	30	40	50	60	70	80
Months	-	12	24	36	48	60	72	84	96	

CHASSIS AND BODY

Exhaust pipes & mountings	-	I	I	I	I	I	I	I	I	I
Brake/clutch fluid (3)	I	I	R*	I	R*	I	R*	I	R*	
Parking brake/Brake pads (Front & Rear) (4)	-	I	I	I	I	I	I	I	I	I
Brake line & connections (including booster)	I	I	I	I	I	I	I	I	I	I
Manual transmission fluid (3)	-	R	I	I	I	I	I	I	I	I
Clutch & brake pedal free play	-	I	I	I	I	I	I	I	I	I
Front & Rear Differential fluid (3)	-	I	R*	I	R*	I	R*	I	R*	
Transfer case fluid (3)	-	I	I	R	I	I	R	I	I	
Automatic transmission fluid (BTRA M74LE) (5)	-	I	I	I	R*	I	I	I	I	I

Chart Symbols :

I - Inspect these items and their related parts. If necessary, correct, clean, replenish, adjust or replace.

R - Replace or change.

* - mileage (km) intervals only

(3) Refer to "Recommended fluids and lubricants".

(4) More frequent maintenance is required if under severe condition : short distance driving, extensive idling, frequent low - speed operation in stop-and-go traffic or driving in dusty condition.

(5) Change automatic transmission fluid and filter every 60,000km if the vehicle is mainly driven under severe conditions.

- In heavy city traffic where the outside temperature regularly reaches 32°C (90°F) or higher, or
- In hilly or mountainous terrain, or
- When doing frequent trailer towing, or
- Uses such as found in taxi, police or delivery service.

7-44 SERVICE AND MAINTENANCE

MAINTENANCE INTERVAL \ MAINTENANCE ITEM	Kilometers (miles) or time in months, whichever comes first									
	x1,000 km	1	15	30	45	60	75	90	105	120
x1,000 miles	0.6	10	20	30	40	50	60	70	80	
Months	-	12	24	36	48	60	72	84	96	

Chassis & underbody bolts & nuts tight / Secure (6)*	I	I	I	I	I	I	I	I	I	I
Tyre condition & inflation pressure	I	I	I	I	I	I	I	I	I	I
Wheel alignment (7)*	Inspect when abnormal condition is noted									
Steering wheel & linkage	-	I	I	I	I	I	I	I	I	I
Power steering fluid & lines (3)*	-	I	I	I	I	I	I	I	I	I
Drive shaft boots	I	I	I	I	I	I	I	I	I	I
Seat belts, buckles & anchors	I	I	I	I	I	I	I	I	I	I
Lubricate locks, hinges & bonnet latch	I	I	I	I	I	I	I	I	I	I
Wheel bearing grease	I	I	I	I	I	I	I	I	I	I
Propeller shaft grease - Front / Rear (8)*	I	I	I	I	I	I	I	I	I	I

Chart Symbols:

I - Inspect these items and their related parts. If necessary, correct, clean, replenish, adjust or replace.

R - Replace or change.

(3)* Refer to "Recommended fluids and lubricants".

(6)* After completion of off-road operation, the underbody of the vehicle should be thoroughly inspected. Examine threaded fasteners for looseness.

(7)* If necessary, rotate and balance wheels.

(8)* Inspect propeller shaft grease every 5,000 km or 3 months if the vehicle is mainly driven under severe condition.

- In off-road or dusty road, or

- In heavy city traffic where the outside temperature regularly reaches 32°C (90°F) or higher, or

- In hilly or mountainous terrain.



8

VEHICLE CARE



K140_RHD_EN_08.p65

1



2004-11-11, 14:09



CLEANING AGENTS

Follow the manufacturer's advice whenever cleaning agents or other chemicals are used, inside or outside the vehicle. Some cleaners may be poisonous or flammable, and improper use may cause personal injury or damage. When cleaning the inside or outside of the vehicle, do not use volatile cleaning solvents such as : acetone, lacquer thinners, enamel reducers, nail polish removers: or cleaning materials such as laundry soaps, bleaches or reducing agents, except as noted in the fabric cleaning advice on stain removal. Never use carbon tetrachloride, petrol, benzene, or naphtha for any cleaning purpose. Open all vehicle doors for ventilation when any cleaning agents or other chemical are used in the interior. Overexposure to some vapors may result in a health problem which is more likely to occur in small, unventilated spaces.

To avoid possible permanent discoloration of light colored seats, do not let materials with non-fast colors come in contact with seat trim materials until these materials are totally dry. This includes certain types of casual clothing, such as colored denims, corduroys, leathers and suedes : also decorative paper, etc.

CARE AND CLEANING OF THE INTERIOR

With the use of modern trim materials, it is very important that you use proper cleaning techniques and cleaners. Failing to do this on the first cleaning may result in water spots, spot rings, or setting of stains or soils-all of which are more difficult to remove in a second cleaning.

Dust and loose dirt that collect on interior fabrics should be frequently removed with a vacuum cleaner or soft bristle brush. Wipe vinyl or leather trim regularly with a clean damp cloth. Normal trim soils, spots or stains can be cleaned with cleaners:

Safety Belt Care

- Keep belts clean and dry.
- Clean safety belts only with mild soap and lukewarm water.
- Do not bleach or dye belts since this may severely weaken them.

GLASS SURFACES

Glass surfaces should be cleaned on a regular basis. The use of glass cleaner or a liquid household glass cleaner will remove normal tobacco smoke and dust films sometimes caused by ingredients used in vinyl's and interior plastics.

Never use abrasive cleaners on any vehicle glass, as they may cause scratches. If abrasive cleaners are used on the inside of the rear window, any electric demister element may be damaged. Avoid placing decals on the inside rear window, since they may have to be scraped off later.

Cleaning the Outside of Windshield

If your windshield is not clear after using the windshield washer, or if the wiper blade chatters when running, wax or another material may be on the blade or windshield. Clean the outside of the windshield with cleaning powder or an equivalent non abrasive cleaner. Your windshield is clean if beads do not form when rinsing with water.



CARE AND CLEANING OF THE EXTERIOR

Exterior Finish

The paint finish on your vehicle provides beauty, depth of color, gloss retention and durability.

Washing Your Vehicle

The best way to preserve your vehicle's finish is to keep it clean by frequent washings.

Wash the vehicle in lukewarm or cold water.

Do not use hot water or wash your vehicle in the direct rays of the sun. Do not use strong soap or chemical detergent. All cleaning agents should be flushed promptly from the surface and not allowed to dry on the finish.

Ssangyong vehicles are designed to operate under normal environmental conditions and to withstand the natural elements. However, unusual conditions, such as high pressure car washes, may cause water to enter inside the vehicle.

Polishing and Waxing

Periodic polishing and waxing is recommended to remove surface residue from your paint finish. Approved products are supplied through your Ssangyong Dealer.

Protecting Exterior Bright Metal Parts

Bright metal parts should be cleaned regularly to keep their luster. Washing with water is all that is usually needed.

Use special care with aluminum trim. To avoid damaging protective trim, never use automotive or chrome polish, steam, or caustic soap to clean aluminum. A coating of wax, rubbed to a high polish, is recommended for all bright metal parts.

Cleaning Aluminum Wheels, Rally Wheels, and Wheel Covers

Preserve the original appearance of wheels or wheel covers by keeping them clean and free from build-up of road dirt and/or road salt. Regular cleaning is recommended. Do not use abrasive cleaners or cleaning brushes, as they could damage the finish.

CORROSION PROTECTION

Your car was designed to resist corrosion. Special materials and protective finishes were used on most parts of your car when it was built to help maintain a good appearance, strength and reliable operation. Some parts which normally are not visible (such as certain parts located in the engine compartment and the underbody of the vehicle) are such that surface rust will not affect their reliability. Therefore, corrosion protection is not needed or used on these parts.

Sheet Metal Damage

If your car is damaged and requires body panel repair or replacement, make sure the body repair shop applies proper anticorrosion material to the parts repaired or replaced so that corrosion protection is restored. (Also see "Finish damage" which follows).

Foreign Material Deposits

Calcium chloride and other salts, ice melting agents, road oil and tar, tree sap, bird droppings, chemicals from industrial chimneys and other foreign matter may damage vehicle finishes if left on painted surface. Prompt washing may not completely remove

all of these deposits. Other cleaners may be needed.

When using chemical cleaners, be sure they are safe for use on painted surfaces.

Finish Damage

Any stone chips, fractures or deep scratches in the finish should be repaired promptly. Bare metal will corrode quickly and may develop into a major repair expense. Minor chips and scratches can be repaired with touch-up materials. Larger areas of finish damage can be corrected in your Dealer's body and paint shop.

Underbody Maintenance

Corrosive materials used for ice and snow removal and dust control can collect on the underbody. If these materials are not removed, accelerated corrosion (rust) can occur on underbody parts such as fuel lines, frame, floor pan and the exhaust system even though they have been provided with corrosion protection.

At least every spring, flush these materials from the underbody with plain water.

Take care to clean any areas where mud and other debris can collect. Sediment packed in closed areas of the frame should be loosened before being flushed. If desired, your Ssangyong Dealer can do this service for you.

CAUTION

When an engine is washed, fuel, grease and oil residues are washed off. Therefore you should use only a filling station or a Ssangyong Dealer who has oil separator equipment in the car wash bay.

Used engine oil, brake fluid, transmission fluid, antifreeze, batteries and tyres should be disposed of by using the local authorized waste disposal facilities, or have them disposed of by the vendor who is under a statutory obligation to do so when you replace them.

On no account must any of these items be placed in the household refuse bins or the fluids poured down the drains.

Everyone should be concerned about environmental protection. Help by doing your share.

IMPORTANT SAFETY INSTRUCTIONS**BEFORE DRIVING**

For safe and comfortable driving, check each part of the vehicle before starting off your vehicle.

CAUTION

To inspect your vehicle effectively, park it on level surface and check it in the following order.

Checking Problematic Parts

Check those parts that you felt were problematic to see if they would be a hindrance on the road.

Checking the External Appearance of Your Vehicle

- Check for flat tires and check the air pressure.
- Check side mirror and license plate for dirt or damage.
- Check all lights for damage or dirt.
- Check for oil stains under parked car.

Take Driver's Seat and Check the**Following:**

- Adjustment of the rearview mirror
- Applying the brake and releasing the parking brake
- All warning lights and indicator lights
- All lighting devices
- The adjustment of driver's seat
- Make sure that headlights, tail lights, rear lights, license plate lights, backup lights, directional signals and stop lights work properly.

CAUTION

When checking the lights, look for the reflections on walls and in the mirrors or get someone to help you.

Checking Engine Compartment

Check the following:

- engine oil
- power steering fluid
- brake fluid
- cooling system
- drive belt

Always Using Seatbelt

Driver and all passengers must wear properly fastened seatbelts.

WARNING

- *Children, pregnant or nursing women who fail to fasten their seatbelts properly might suffer an accident. Always use seatbelts as directed.*
- *Familiarize yourself with seats, seatbelts and airbags.*

Taking Care of Children**• Children go to the rear seat**

To prevent children from interfering with your driving by accidental movements or misuse of devices, put children to the rear seat.

• Adults adjust comfort and safety devices

When a child gets in the vehicle, an adult should take care of doors, windows, seatbelts and seats making sure not to hurt the child's hands, feet or neck.

Do Not Leave Children Alone in the Vehicle

When left alone in the car, a child might unintentionally start the engine or start a fire or cause another accident.

⚠ WARNING

- *In summer, the temperature in your vehicle rises due to direct sunlight, and a child who is unable to adjust vehicle devices is in danger of suffocation.*
- *Do not leave a child alone in the car with no open windows.*

ON THE ROAD**If a Problem Occurs on the Road**

- If a warning light goes on, immediately stop the vehicle in a safe place and take emergency measures.
- If your vehicle suffered a serious blow to the bottom, immediately stop the vehicle in a safe place and check for fuel leak or brake fluid spill and for damages to the car underbody.
- If you have a sudden puncture or blow-out on the road, keep your composure, grip the steering wheel firmly, brake gently to reduce your speed and then stop in a safe place.

⚠ WARNING

If the front axle and tire were severely hit on the road and you notice steering problems (steering wheel shakes up and down / right and left / in circular motion), immediately visit to the nearest Ssangyong Dealer or Ssangyong Authorized Service Operation to check and repair steering and suspension parts.

Avoiding Unnecessary Movements While Driving

- While driving, do not turn off the ignition key under no circumstances. Brakes and power steering will not work.
- While driving, do not put hands through the steering wheel to manipulate various switches. It might interfere with operating the steering wheel and cause an accident.

Parking in a Safe Place

Do not park in places where hay, foliage, paper, rags and oil or other easily inflammable materials are kept.

⚠ CAUTION

While driving or after immediately driving, muffler and exhaust pipe are hot; inflammable materials near the vehicle might cause a fire.

Turning the Engine Off when Taking a Nap

You might cause an accident by unconsciously shifting the transaxle or stepping on the accelerator pedal, so turn the engine off.

CAUTION

Repeated application of the accelerator pedal overheats the engine and exhaust pipe and might cause a fire.

Turning the Engine Off when Leaving Your Car

- Turn the engine off and lock the doors.
- Do not leave valuables inside the car; help children out of the car.

Moving Your Vehicle Only After Starting the Engine

Move your vehicle only after having started the engine.

WARNING

Driving the vehicle downhill using the downgrade slope without running the engine might cause an accident.

Parking Downhill

After firmly applying the park brake, set the gearshift lever in Reverse for the vehicle with manual transmission or set the gearshift lever in **P** for vehicle with automatic transmission.

CAUTION

Place wheel chocks under the wheels.

Parking Uphill

After firmly applying the park brake, set the gearshift lever in first gear for vehicle with manual transmission or set the gearshift lever in **P** for vehicle with automatic transmission.

CAUTION

Place wheel chocks under the wheels.

When Parking or Stopping in an Enclosed Place

When parking or stopping in an enclosed place, turn off the engine.

WARNING

Leaving the engine running in an enclosed place, in a garage or indoors or in other areas with no air circulation, might result in death from carbon monoxide poisoning.

Things to Watch for when Backing Up

When backing up your vehicle, always make sure that there are no children or other obstacles behind the car.

Driving in the Rain

When it is raining the road surface becomes slippery and your tire-to-road traction is reduced, so you should drive more carefully than usual.

CAUTION

If you travel at a high speed on a wet road, your tires might not be in constant contact with the road; if your tires float, your vehicle starts hydroplaning. You might lose control of your steering and brakes.

After driving through a puddle of water, or after a car wash, apply your brake pedal lightly several times while moving slowly to confirm that your brakes work normally before getting on the road.

Putting Away Things that Interfere with Driving**WARNING**

- *Do not leave inflammable materials, such as disposable lighters or sprays, inside the vehicle. They might cause a fire or an explosion.*
- *Do not place objects under the driver's feet or cover the car bottom with a very thick carpet as it might interfere with applying your brake, clutch and accelerator pedals.*

Using Engine Brakes on Long Downgrades

If you repeatedly apply the brake pedal, the brakes overheat and the braking effectiveness can deteriorate. When on a long downgrade, shift to low gear and apply your brake pedal together with engine brake.

NOTE

Engine brake allows for slowing of the vehicle while the accelerator pedal is not applied; down-shifting increases the effectiveness of this retarding force.

Always Putting Out Cigarettes

- Make sure you have put out all cigarettes and matches completely before throwing them into your ashtray.
- Do not put many cigarette butts or materials that easily catch fire into your ashtray.

CAUTION

For safer driving, refrain from smoking while on the road.

Being Careful with Accessories

Do not attach accessories or other unnecessary things to your car's window as they might interfere with your driving. Attached accessory can work as a lens and start a fire or cause an accident.

Being Careful while Checking Your Coolant

When engine is hot, never open the cap of the coolant tank. Hot steam or liquid might surge upwards and cause burns to your face or body.

Always Using Ssangyong Genuine Parts

- You can maintain the safety and performance of your car by using only specified parts or Ssangyong genuine parts.
- You can distinguish specified parts by their parts number and seal.

CAUTION

- *Warranty does not cover problems caused by using non-Ssangyong genuine parts.*
- *You can distinguish an authentic Ssangyong genuine part by its hologram.*

Driving on a Snowy or Icy Road

- Shift to the lowest possible gear and drive slowly.
- Since your braking distance is longer than usual, allow greater following distance.
- If you accelerate or brake too fast, your vehicle will slide and you might get in an accident, so drive with caution. When braking, use engine brake; apply your brakes only after you have slowed down considerably.
- When going downhill on a slippery road, use engine brake and drive slowly.

CAUTION

When traveling on snowy or icy road, use snow tires for safer driving.

Driving on Sandy or Muddy Road

- Keep your speed steady and as low as possible.
- While driving, be careful not to accelerate or stop too quickly because you might get stuck in sand or mud.
- If your vehicle gets stuck in sand or mud, insert a rock or a piece of wood under the stuck wheel, lightly apply the accelerator pedal and gently shift back and force between reverse and forward gear to allow inertia get your vehicle out.

CAUTION

- *If your vehicle is stuck in sand or mud and you cannot get out, do not repeatedly step on the accelerator pedal. If possible, get another vehicle to tow you.*

Driving on Unpaved and Mountain Roads

- Before driving, check road conditions such as if the road suddenly ends and if there is enough space for a U-turn in the middle of the road.
- It's easy to slide in a road covered with much sand or with much dry dirt. Keep your speed low and steady.
- There is a danger of driving off the mountain road, so stay alert.
- When coasting downhill, do not change gears; go down slowly applying engine brake.

Going Through Water

- If water gets into the electric system or engine, it might cause irreparable damage to your vehicle. Please refrain from underwater driving.
- If going through water is unavoidable, choose a shallow spot where the exhaust outlet wouldn't get submerged in water and proceed slowly at a steady speed.
- Before going through water, get out of your vehicle and check the bottom of the river. Do not go through water if the bottom is sandy or covered with big rocks.
- If several vehicles are going through water together, the first vehicle might burrow into the bottom, so be careful and cross in a different place if possible.

Important things to remember when going through water

- If the engine stops while you are going through water, do not try to restart. Get your vehicle towed.
- Be particularly careful not to allow water inside your engine through air cleaner.
- Never change speeds while going through water.

WARNING

If water gets into the brake system, the effectiveness of the brakes decreases. After going through water, move slowly and gently apply brakes several times so that frictional heat dries brake pads and disks. Check if the brakes work properly before continuing driving.

- **Checking your vehicle after going through water**
- Check front, rear, right and left sides, transmission, axle hubs, propeller shaft, oil and fluid levels and underbody; if you discover problems, get your vehicle checked immediately.
- Check all lamps and other electrical devices. If necessary, replace damaged components and get your vehicle checked.
- Check for damages to the vehicle body and underbody; if you discover problems, get your vehicle checked immediately.
- If the vehicle body is very dirty, wash your car to protect it.

Driving on Hill Roads

Position the gearshift lever in accordance with the road conditions.

- On a steep downgrade, shift to the lowest gear to get the biggest engine brake effect.

WARNING
If you suddenly use engine brake on an icy or slippery road, the vehicle might slide and get in an accident. Use engine brakes after fully accelerating your vehicle.

WARNING
If you repeatedly apply your brakes on a long downgrade, they may overheat, their effectiveness decreases and an accident might occur. When on a long downgrade, use the engine brake together with your brakes.

CAUTION
If you suddenly apply the engine brake while traveling at a high speed, the engine may get damaged. Slow down the vehicle speed and then downshift the gear.

Freeway Driving

- Before getting on a freeway, listen to the weather forecast, prepare thoroughly and check the fuel level, brake system, cooling system and tires.
- Always respect the speed limit and refrain from speeding.
- Allow for a safe following distance, avoid sudden steering movements.
- When it rains or snows and the weather conditions are bad, allow for the following distance that is twice as great as usual and reduce your speed by half.

CAUTION

Do not idle the engine for a long time; it wastes fuel and causes environmental pollution.

- ***Drive at a slow speed for the first 2 km if possible.***
- ***Do not load your vehicle with unnecessary stuff.***
- ***Refrain from quick accelerating and abrupt braking, travel at a steady speed.***
- ***When you park or stop for a long time, turn the engine off.***
- ***Keep tires at the recommended pressure.***
- ***Keep your vehicle in the best possible condition by periodically checking it and perform maintenance.***

PROHIBITION OF UNAUTHORIZED MODIFICATIONS

This vehicle contains various advanced electric, electronic and control devices. Do not modify them without authorization.

Modification of Fuses and Circuits

Always use the Ssangyong genuine fuses of the specified capacity and do not alter or modify your vehicle's circuits. It might cause a fire.

Prohibition of Window Tinting

Modifications such as coloring windows might cause leaks. Tinting all the windows in a vehicle with a navigation system might weaken the satellite signal and make it impossible to display the vehicle's current location.

Using Non-Specified Tires and Wheels

If using non-specified parts, steering wheel feels heavier, fuel consumption increases, brake performance decreases and steering wheel might shake wearing out tires when you are traveling at a high speed.

Performing Regular Checks

Always check your vehicle following the inspection schedule, replace parts when necessary and record in your vehicle diary which parts were replaced.



9

SPECIFICATION AND SERVICE DATA



K140_RHD_EN_09.p65

1



2004-11-11, 14:09



9-2 SPECIFICATION AND SERVICE DATA

OFFICIAL VEHICLE IDENTIFICATION DATA

The vehicle identification number is stamped on the vehicle identification plate on the left-hand side of the cowl panel.

ENGINE NUMBER

Diesel Engine

The engine number is stamped on the cylinder block in front of injection pump.

G32D Engine

The engine number is stamped on lower front right-hand side of the cylinder block.

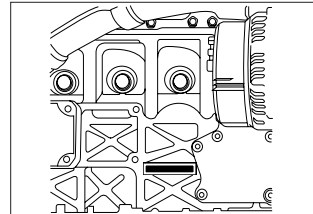
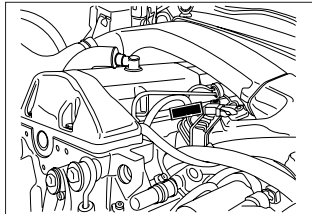
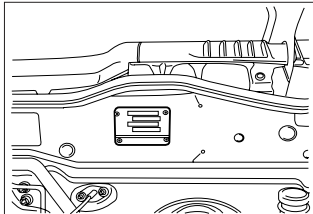



G23D Engine

The engine number is stamped on the upper rear left-hand side of the cylinder block.

CHASSIS NUMBER

Chassis number is stamped on the front right-hand side of the frame member.

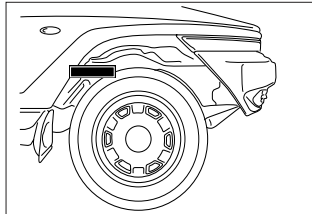
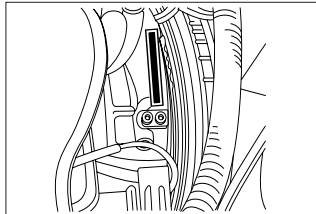

9-4 SPECIFICATION AND SERVICE DATA

LUBRICATION CHART

Lubricant		Capacity		Classification	
Engine oil	Diesel	D29ST	7.5 ~ 9.5 L	Quality class**	MB sheet : 229.1/3 (preferable) (API : CG grade or above ACEA : B2, B3 or B4)
				Viscosity	MB sheet No. 224.1
	Gasoline	G23D	6.0 ~ 7.5 L	Quality class**	MB sheet : 229.1/3 (API : SJ grade or above ACEA : A2 or A3)
		G32D	6.7 ~ 8.2 L	Viscosity	MB sheet No. 224.1
Engine coolant (Coolant/Distilled water Mixture)		D29ST	10.5 L	MB sheet 325.0, BASF GLYSANTIN G05-11, HOECHST GENANTIN SUPER 8023/14	
		G23D	10.5 L		
		G32D	11.3 L		
Manual transmission oil		4WD : 3.6 L / 2WD: 3.4 L		ATF DEXRON® II	
Brake/Clutch fluid (Level must be maintained between MAX & MIN level)		Brake fluid : approx. 0.7 L		SAE J 1703, DOT 3 or DOT 4	
		Clutch fluid : approx. 0.3 L			
Power steering fluid		1.0 L		ATF DEXRON® II, III / Total fluid ATX	
Automatic transmission fluid (BTRA M74LE)*		9.5 L		CASTROL TQ 95	
Transfer case fluid		Part time: 1.2 L / TOD: 1.4 L		ATF DEXRON® III	
Front & Rear axle fluid	Front	Tong-IL: 1.0 L / Dymos: 1.2 L		SAE 80W/90	
	Rear	1.9 L		API GL-5	
Wheel bearing grease		Properly		SHELL Retinax "A" grade	
Propeller shaft grease - Front/Rear		Properly		ALVANIA EP#2	

* Please contact Ssangyong Dealer for approved alternative fluid.

** In only case not available MB sheet specification API and/or ACEA specification oil may be used, however it would rather recommend to shorten change interval around 30%.

ENGINE OIL

SAE viscosity classes

The SAE classes (viscosity) should be selected in accordance with the average seasonal air temperature.

Applying the SAE classes exactly on the basis of the outside air temperatures would necessitate frequently changing the engine oil. The temperature limits for the SAE classes should therefore be regarded as reference temperatures and the actual air temperature may be higher or lower for a short period of time.

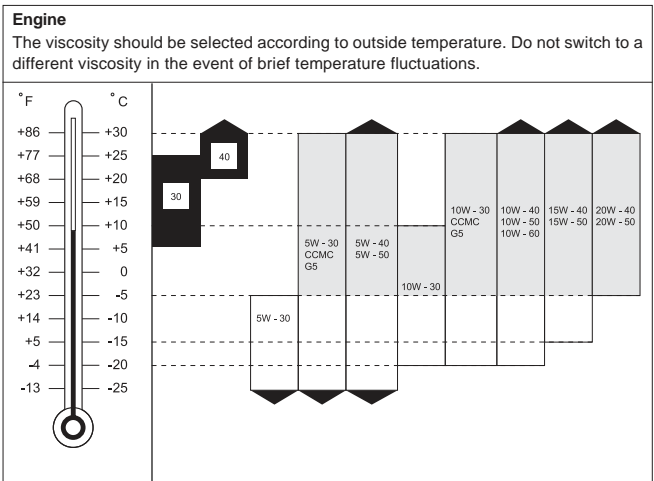

9-6 SPECIFICATION AND SERVICE DATA

SPECIFICATION

All data apply to vehicles with standard equipment. Optional extras may alter some of these data. For more information, please contact any Ssangyong Dealer.

Items		Model	D29ST	G23D	G32D
Vehicle dimensions (mm)	Overall length		4330	←	←
	Overall width		1841	←	←
	Overall height		1840	←	←
	Wheel base		2480	←	←
	Ground clearance		195	←	←
	Tread	Front		1510	←
Rear			1520	←	←
Weight (kg)	Curb weight	Manual	1830	1790	1840
		Automatic	1850	1810	1860
	Gross vehicle weight		2515	←	←
	Persons (s/top)		5 (4)	←	←

Items		Model	D29ST	G23D	G32D
Performance	Maximum speed (km/h)	M/T	150	165	176
		A/T	140	160	170
	Gradeability (tan θ)		0.94	0.765	0.949
	Min. turning radius (m)		5.25	←	←
Transmission (Manual)	Gear ratio	1st	4.007	←	←
		2nd	2.365	←	←
		3rd	1.473	←	←
		4th	1.000	←	←
		5th	0.872	←	←
		Reverse	3.700	←	←
	Final drive ratio		3.91	4.55	3.73

9-8 SPECIFICATION AND SERVICE DATA

Items		Model	D29ST	G23D	G32D
Transmission (Automatic)	Gear ratio	1st	2.742	←	←
		2nd	1.508	←	←
		3rd	1.000	←	←
		4th	0.708	←	←
		Reverse	2.428	←	←
		Final drive ratio	4.89	5.86	4.55
Engine	Type		5 Cylinder Diesel	4 Cylinder Gasoline	6 Cylinder Gasoline
	Total displacement (cc)		2874	2295	3199
	Bore x stroke (mm)		89.0 x 92.4	90.9 x 88.4	89.9 x 84
	Compression ratio		22:1	10.4:1	10.0:1
	Max. power (ps/rpm)		120/4000	150/6200	220/6500
	Max. torque (N•m/rpm)		256/2100	210/2800	307/4700
	BTDC		18°	7.5°	8°

SPECIFICATION AND SERVICE DATA 9-9

Items		Model	D29ST	G23D	G32D
Tyre	Size		P 235/ 75R 15 P 235/ 70R 16* P 255/ 65R 16*	←	←
Fuel system	Fuel tank (L)		70	←	←
Cooling system	Coolant (L)		10.5	10.5	11.3
Lubricating	Engine oil (L)		8.0 - 9.5	6.0 - 7.5	6.7 - 8.2
Electrical system	Battery (V-AH) (MF)		12 - 90	12 - 75	←
	Starter (V-kw)		12 - 2.2	12 - 1.2	12 - 1.8
	Alternator (V-A)		12 - 75	12 - 115	←
Clutch	Size (mm) (Outside diameter x inside diameter x thickness)		240 x 155 x 8.4	225 x 150 x 9.2	240 x 155 x 8.4

9-10 SPECIFICATION AND SERVICE DATA

Items		Model	D29ST	G23D	G32D
Brake	Front wheel		DISC	←	←
	Rear wheel		DISC	←	←
	Booster (inch)		8" ± 9"	←	←
Steering system	Type (Power steering)		RACK & PINION	←	←



10

INDEX



K140_RHD_EN_10.p65

1



2004-11-11, 14:09



10-2 INDEX

4-wheel drive operation 2-12
 4 wheel drive switch 3-29
 4WD indicator 3-18

A

A note on safety 7-6
 ABS warning light* 3-12
 Air bag warning light* 3-14
 Air bag* 1-33
 Air cleaner 7-17
 Air vents 4-2
 Anti-lock brake system* (ABS) 2-16
 Ashtray 3-31
 Assist grip 3-32
 Auto shift indicator* 3-17
 Automatic air conditioner 4-11
 Automatic dimming inside rearview mirror* 1-14
 Automatic door locking release 1-9
 Automatic door locking system 1-9
 Automatic transmission emergency shifting procedure 2-10
 Automatic transmission fluid* 7-15

B

Battery charge warning light 3-13
 Battery maintenance 7-22

Before driving off 1-2
 Before entering the car 1-2
 Before starting the engine 2-4
 Brake fluid 7-12
 Brake pedal 7-23
 Brake system warning light 3-11
 Brake 2-15
 Bulb specification 7-32

C

Care and cleaning of the exterior 8-3
 Care and cleaning of the interior 8-2
 Catalytic converter* 7-24
 Center armrest console 3-32
 Central door locking system 1-9
 Chassis number 9-3
 Child restraint 1-24
 Cigarette lighter 3-30
 Cleaning agents 8-2
 Clutch fluid 7-13
 Clutch pedal 7-23
 Coolant level 7-9
 Corrosion protection 8-4
 Courtesy light 3-35
 Cruise control* (for gasoline engine) .. 3-24
 Cup holder 3-32

D

Daytime running lights indicator* 3-20
 Digital clock 3-18
 Door courtesy lamp 7-38
 Door locks 1-7
 Door open warning light 3-13
 Drive belt 7-20
 Driver's check list 7-6
 Driver's seat height adjustment* 1-16
 Driver's seat warmer* 1-16
 Driving tips for automatic transmission* 2-10
 Driving with a manual transmission 2-5
 Driving with an automatic transmission* 2-6

E

EBD warning light* 3-13
 Electrical system 7-28
 Emergency towing 6-10
 Engine compartment 5-2
 Engine compartment 7-2
 Engine exhaust gas caution (carbon monoxide) 2-20
 Engine hood 1-37
 Engine number 9-2
 Engine oil pressure warning light 3-9

- Engine oil 7-7
 Engine oil 9-5
- F**
- Fixing sun roof 1-45
 Fog lamp indicator (front & rear*) 3-15
 Folding rear seat 1-19
 Front combination lamps (turn signal lamps and position lamps) 7-33
 Front fog lamp switch* 3-21
 Front fog lamps 7-34
 Front room lamp 7-37
 Front seat back storage pocket 1-17
 Front seat reclining adjustment 1-15
 Front seat slide adjustment 1-15
 Fuel filler door release lever 1-36
 Fuel filter 7-19
 Fuel gauge 3-9
 Fuel recommendation 2-2
 Fuse box 7-29
- G**
- Glass surfaces 8-2
 Glove box 3-34
 Glow indicator (for diesel engine) 3-16
- H**
- Hazard warning flasher switch* 3-27
 Hazardous driving 2-21
 Head restraints 1-17
 Headlamp leveling switch* 3-29
 Headlamps 7-33
 High-mounted stop lamp (for vehicles with canvas roof) 7-36
 High-mounted stop lamp (for vehicles with metal roof) 7-36
 High beam indicator 3-15
 High beam switch 3-20
 Horn switch 3-30
 How to change a flat tyre 6-3
- I**
- Ignition switch 2-3
 Immobilizer system* 2-5
 Important safety instructions 8-5
 Inside rearview mirror 1-14
 Instruments and controls with automatic transmission 3-3
 Instruments and controls with manual transmission 3-2
 Instruments 3-5
 Introduction 5-3
- K**
- Key with integrated transponder and illumination* 1-3
 Key 1-3
 Keyless entry system with anti-theft function* 1-4
 Keyless entry transmitter 1-6
- L**
- Lap belt 1-30
 License plate lamps 7-36
 Light switch 3-19
 Low fuel level warning light 3-9
 Lubrication chart 9-4
 Luggage hooks 3-34
 Luggage room lamp 3-35
 Luggage room lamp 7-37
- M**
- Malfunction indicator lamp 3-10
 Manual air conditioning 4-3
 Manual transmission fluid 7-15
 Map pocket 3-33
 Mode switch 2-9
- O**
- ODO meter and trip odometer 3-8
 Official vehicle identification data 9-2

10-4 INDEX

Open / close sun roof 1-44
 Opening / closing method of canvas assembly 1-39
 Operation tip 2-14
 Outside rearview mirrors 1-13

P

Parking brake 2-18
 Parking brake 7-24
 Passing light switch 3-21
 Power mode indicator 3-17
 Power outside rearview mirrors 1-12
 Power steering fluid 7-16
 Power windows 1-10
 Preventive maintenance 5-4

R

Rear combination lamps (brake, rear turn signal, reverse, and rear fog* lamps) .. 7-35
 Rear fog lamp switch* 3-28
 Rear room lamp 7-37
 Rear seat entry 1-18
 Rear three point seat belt (center)* 1-31
 Reclining rear seat back 1-18
 Room lamp 3-34
 Running-in period 1-2

S

Scheduled maintenance services (diesel engine) 7-39
 Scheduled maintenance services (gasoline engine) 7-42
 Seat belt height adjustor 1-32
 Seat belt precautions 1-21
 Seat belt pretensioner* 1-32
 Seat belt reminder 3-14
 Service precautions 7-5
 Side armrest 1-18
 Side repeater lamps 7-35
 Spare wheel, jack and vehicle tools 6-2
 Spark plugs 7-19
 Specification 9-6
 Speedometer 3-7
 Starting the engine with jumper cables 6-6
 Starting the engine 2-4
 Suggestions for more economical operation 2-19
 Sun visors 3-33

T

T.O.D (Torque On Demand)* 2-13
 Tachometer 3-7
 Tailgate glass defogger indicator 3-16

Tailgate locks 1-10
 Tailgate window defogger switch 3-28
 Tailgate window wiper and washer switch 3-23
 TCS (traction control system) indicator* 3-16
 Temperature gauge 3-8
 Three point seat belt 1-28
 Tilttable steering wheel 1-12
 Towing a disabled vehicle 6-9
 Traction control system* (with anti-lock brake system) 2-17
 Transfer case fluid 7-18
 Turbocharger inspection 5-4
 Turn signal switch 3-20
 Turn signal/hazard warning flasher indicator 3-15

U

Unfolding rear seat 1-20

V

Ventilation and heating 4-2



W

Wheels and tyres 7-25
Windshield washer fluid 7-20
Windshield washer switch 3-22
Windshield wiper switch 3-21
Windshield wipers 7-21
Winter mode indicator 3-17







KORANDO (RHD) OWNER'S MANUAL

ISSUED BY
INTERNATIONAL A/S TEAM
SSANGYONG MOTOR CO., LTD.

150-3, CHILGOI-DONG, PYUNGTAEK-SI
GYEONGGI-DO, 459-711 KOREA

TELEPHONE : 82-31-610-2740
FACSIMILE : 82-31-610-3762

*NOTE: All rights reserved. Printed in SSANGYONG Motor Co., Ltd.
No part of this book may be used or reproduced without the
written permission of International A/S Team.*





EDITION HISTORY

No.	CODE NO.	PRINTING DATE	MODEL YEAR	REMARKS
1	RK03-4OM0E-4E-100A	May. 2004	2004	
2	RK03-4OM1E-4I-100A	Sep. 2004	2004	
3	RK03-4OM1E-4J-100B	Oct. 2004	2004	
4	RK03-4OM1E-5E-150C	May. 2005	2005	

