

thesis

Owner Handbook



Dear customer,

Congratulations and thank you for choosing LANCIA.

We wrote this handbook to help you get the most out of your car's outstanding qualities.

We advise to read it right through before taking to the road for the first time.

You will find information, tips and important warnings regarding the driving of your car to help you derive the maximum from your LANCIA's technological features. You will discover unique features and details; you will also find essential information for car care and servicing as well as driving and operating safety not to mention the long-term wellbeing of your LANCIA.

The enclosed Warranty Booklet lists the services you have acquired and contains details relating to the following:

- the Warranty Certificate, with terms and conditions for maintaining it
- the range of services offered to LANCIA owners.

We are sure that these instruments will help you easily attune to and appreciate both your new car and the LANCIA team that will be on hand to provide you with any help you may require.

Best regards and have a great trip!

This Owner Handbook describes all the THESIS versions. You should therefore consider only the information concerning the engine and bodywork version of the car you have bought.

MUST BE READ!

REFUELLING



Petrol engines: only refuel with unleaded petrol with octane rating (RON) no less than 95.

Diesel engines: only refuel with diesel fuel conforming to the European specification EN590.

The use of other products or mixtures may irreparably damage the engine with invalidation of the warranty due to the damage caused.

ENGINE START-UP



Petrol engines with manual gearbox: make sure the parking brake is pulled (instrument panel warning light  on); put the gear lever to neutral; press the clutch pedal down to the floor without touching the accelerator, then turn the ignition key or the Keyless System knob to **AVV** and release it as soon as the engine starts.

Engines with automatic electronic transmission (COMFORTRONIC): make sure the parking brake is pulled (instrument panel warning light  on) and the gear lever is to **P**; hold the clutch pedal pressed down to the floor without touching the accelerator, then turn the ignition key or the Keyless System knob to **AVV** and release it as soon as the engine starts.

Diesel engines: make sure the parking brake is pulled; put the gear lever to neutral; press the clutch pedal down to the floor without touching the accelerator, then turn the ignition key or the Keyless System knob to **MAR**, and wait for the instrument panel warning light  to go out, then turn immediately the ignition key or the Keyless System knob to **AVV** and release it as soon as the engine starts.

PARKING OVER FLAMMABLE MATERIAL



When functioning normally, the catalytic converter reaches high temperatures. For this reason do not park the car over inflammable material, grass, dry leaves, pine needles, etc.: fire hazard.

PROTECTING THE ENVIRONMENT



A system for continuously monitoring emission system components to ensure greater environmental protection is fitted in your car.

ELECTRICAL ACCESSORIES



If, after buying the car, you decide to add electrical accessories (that will gradually drain the battery), visit a **Lancia Dealership**. They can calculate the overall electrical requirement and check that the car's electric system can support the required load.

CODE card



Keep the code card in a safe place, not in the car. You should always keep the electronic code written on the CODE card with you in case you need to carry out an emergency start-up procedure.



SCHEDULED SERVICING



Correct maintenance of the car is essential for ensuring it stays in tip-top condition and safeguards its safety features, its environmental friendliness and low running costs for a long time to come.

THE OWNER HANDBOOK CONTAINS ...



... information, tips and important warnings regarding the safe, correct driving of your car, and its maintenance. Pay particular attention to the symbols  (personal safety)  (environmental protection)  (the car's wellbeing).

TRAVELLING SAFELY AND IN HARMONY WITH NATURE

Safety and respect for the environment are the guidelines that inspired the THESIS design from the drawing board onwards.

This concept has meant that the THESIS has been able to face and pass the strictest safety tests. So much so that, from this point of view, the car is the best in its class and has probably already incorporated features that belong to the future.

In addition, ongoing research into new and effective features to help safeguard the environment makes the THESIS a car to imitate for this reason as well.

All versions are in fact equipped with environmental protection devices that reduce harmful exhaust fumes in compliance with the limits provided for by current legislation.

SAFEGUARDING THE ENVIRONMENT

Safeguarding the environment has directed the design and manufacturing of the THESIS right from the start. The result is the use of materials and the perfection of devices that can reduce or sweepingly reduce harmful influences on the environment.

The THESIS is equipped with environment safeguarding devices which curtail harmful exhaust gas emissions, is ready to travel well ahead of the most stringent international pollution control standards.

USE OF ENVIRONMENT-FRIENDLY MATERIALS

None of the car's components contain asbestos. Padding and the climate control system do not contain CFCs (chlorofluorocarbides) - the gases considered responsible for the destruction of the ozone layer. Other substances that might pollute air and water tables, such as the cadmium in the rust-proof coating of the bolts, have been completely replaced with substances that do not harm the environment.

DEVICES FOR REDUCING PETROL ENGINE EMISSIONS

Three-way catalytic converter (catalytic exhaust pipe)

The exhaust system is equipped with a catalyst made up of noble metal alloys; it is housed in a stainless steel container capable of withstanding the very high operating temperatures.

The catalyst converts the unburnt hydrocarbons, the carbon monoxide and the nitric oxides found in the exhaust gases (though in small amounts, thanks to the electronic-injection ignition systems) into non-polluting substances.

When functioning normally, the catalytic converter reaches high temperatures. For this reason do not park the car over inflammable material (e.g. paper, fuel oil, grass, dead leaves, etc.).

Lambda sensors

The Lambda sensors detect the oxygen content in the exhaust gas. The signal sent by the oxygen sensor is used by the injection system electronic control unit to constantly mix air and fuel in the correct proportion.

Fuel evaporation canister

As it is impossible to stop the build up of petrol fumes, also when the engine is not running, the system traps them in a special container holding active carbon.

The fumes are sucked in from here and burnt while the engine is running.

DEVICES FOR REDUCING DIESEL ENGINE EMISSIONS

Oxidising catalytic converter

This device converts the polluting substances in the exhaust gas (carbon monoxide, unburnt hydrocarbons and particulates) into harmless substances, thus reducing the smokiness and smell associated with diesel engine exhaust fumes.

The catalytic converter consists of a stainless steel case containing a honeycomb ceramic core in which there is the precious metal that carries out the catalysing action.

Exhaust Gas Recirculation (E.G.R.) system

This system recirculates or reuses part of the exhaust gas in a proportion which varies according to engine operating conditions.

When necessary, it is used for the control of nitrogen oxide emissions.

THE SIGNS TO HELP YOU DRIVE CORRECTLY

The signs you see on this page are very important. They highlight those parts of the handbook where, more than elsewhere, you should stop for a minute and read carefully.

As you can see, each sign has a different symbol to make it immediately clear and easy to identify the subjects in the different areas:



Personal safety.

Important. Total or partial failure to follow these instructions can place driver, passengers or others in serious danger.



Environmental protection.

This shows you the correct procedures to follow to ensure that the car does not harm the environment.



Car wellbeing.

Important. Total or partial failure to follow these instructions will result in the risk of serious damage to the car and may invalidate the warranty as well.

The texts, illustrations and technical specifications contained in this handbook refer to the car at the time of going to press.

As part of our ongoing effort to improve our products, LANCIA may introduce technical modifications during production and therefore technical specifications and fittings may be altered without prior notice.

For more detailed information, please apply to LANCIA Dealerships.

SYMBOLS

Special coloured labels have been attached near or actually on some of the components of your THESIS. These labels bear symbols that remind you of the precautions to be taken as regards that particular component.

A list of the symbols to be found on your THESIS is given below with the name of the component to which it relates at the side of it.

These symbols are divided into the following four categories: danger, prohibition, warning and obligation.

DANGER SYMBOLS



Battery
Corrosive fluid.



Coil
High voltage.



Battery
Explosion.



Belts and pulleys
Moving parts; keep parts of the body and clothes away.



Fan
May cut in automatically even when the engine is turned off.



Climate control tubing
Do not open. Gas under high-pressure.



Expansion tank
Do not remove the cap when the coolant is hot.



Front headlights
Danger - Electric shocks.

PROHIBITION SYMBOLS



Battery

Keep away from naked flames.



Battery

Keep away from children.



Heat shields - belts - pulleys - fan

Do not touch.

OBLIGATION SYMBOLS



Battery

Protect your eyes.



Battery

Jack

See the Owner handbook.

WARNING SYMBOLS



Catalytic converter

Do not park over inflammable materials. See chapter: "Protecting the emission control devices".



Power steering

Do not exceed the maximum fluid level in the reservoir. Use only the fluid specified in section "Capacities".



Brake circuit

Do not exceed the maximum fluid level in the reservoir. Use only the fluid specified in section "Capacities".



Windscreen wiper

Only use fluid of the type specified in section "Capacities".



Engine

Use only the oil specified in section "Capacities".



Unleaded petrol vehicle

Use only unleaded petrol with a rated octane number (R.O.N.) of not less than 95.



Diesel engines

Use diesel fuel only.



Expansion tank

Only use fluid of the type specified in section "Capacities".

CONTENTS

GETTING TO KNOW YOUR CAR

DRIVING YOUR CAR

IN AN EMERGENCY

CAR MAINTENANCE

TECHNICAL SPECIFICATIONS

INDEX

- 1) Front door air outlets
- 2) Side window vents
- 3) Side vents
- 4) Instrument panel
- 5) Windscreen vent
- 6) Driver's side vents
- 7) Central vents
- 8) Hazard light switch
- 9) Passenger's side vent
- 10) Front passenger's airbag
- 11) Front passenger's airbag deactivation switch
- 12) Glove compartment/CD CHANGER compartment/power socket
- 13) Glove compartment on/off button
- 14) CONNECT multifunction display (for control description see the following pages)
- 15) Cassette player, CD and SIM telephone card slot flap
- 16) Automatic climate control and heated rear window switch
- 17) Ashtray and cigar lighter
- 18) SOS button (for assistance services and functions)
- 19) Windscreen/headlight wiper/washer stalk
- 20) Trip meter reset button (long pressure)/Button for deleting failure messages on the display (short pressure)
- 21) Ignition switch
- 22) CONNECT controls on the steering wheel (for control description see the following pages)
- 23) Horn
- 24) Driver's airbag
- 25) Steering wheel electric adjustment button
- 26) Radar Cruise Control controls/Cruise Control/direction indicator stalk and main/dipped beam headlight switch
- 27) Glove compartment/fusebox cover
- 28) Bonnet opening lever
- 29) Outside light stalk knob - Front and rear fog light buttons - Instrument panel dimmer and twilight sensor sensitivity ring nuts

CONNECT INFOTELEMATIC SYSTEM



fig. 2

The key for this figure is on pages 16-17.

LOA6001b

THESIS CONNECT infotelematic system, in its most refined version, includes: colour TV set, sound system with cassette player, CD-ROM/Audio CD player, CD-changer, GSM cell phone, navigator, trip computer and voice commands (for certain functions of cell phone, audio system and navigator).

The following pages describe the system controls and main functions. The car is provided with a special supplement dealing with CONNECT infotelematic system to be used as quick reference guide for using the system. Read through this supplement carefully and keep it always within reach (e.g. in the glove compartment).

IMPORTANT For the navigation system of the CONNECT, only use only the original CD provided with the car or, in any case other CDs of the same brand.

IMPORTANT The provided phone is of the Single-Band type and therefore if your network provider is not operating with the 900 Mhz GSM standard, coverage troubles may arise notwithstanding the roaming. Contact your network provider for further information.



The Lancia navigation system helps driver while he drives, by suggesting vocally or graphically, the optimum routing to reach his preset destination. Navigation system suggestions do not excuse driver from his full responsibilities due to his driving behaviour and to his compliance with road and other traffic regulations. The responsibility for road safety always lies with the car driver, and it falls on him in any case.





If you drive with the volume too high you put both your own life and that of others in jeopardy. You should adjust the volume so that you can hear noises from outside the car (e.g. horns, ambulance/police sirens, etc.).

CONNECT CONTROLS (fig. 2)

The CONNECT system functions can be managed by means of 29 buttons and 2 rotating selectors (knobs). Certain controls have multiple functions that are dependent on the system operating conditions active.

The type of function that can be actuated by means of the controls depend, in some cases, on how long the button is pressed down (long or short push), as shown in the following table.

| Legend | Short push (less than 2 seconds) | Long push (more than 2 seconds) |
|-------------------|--|--|
| 1 – SOS | Assistance services and functions | – |
| 2 | Slot for navigator CD-ROM or Audio CD | – |
| 3 | Slot for cassette | – |
| 4 – CD | Eject navigator CD-ROM or Audio CD | – |
| 5 – CC | Eject cassette | – |
| 6 – ◀ | Radio mode: search for the first radio station that can be tuned at a lower frequency CD mode: selection of the previous track Cassette mode: fast tape rewind with return to beginning of listened track or to previous track TV mode: search for the first channel that can be tuned at a lower frequency | Radio mode: actuation of the “Scan” mode with scanning of the stations in the selected radio band starting from the lower frequency ones CD mode: fast backward Cassette mode: fast tape rewinding |
| 7 – ▶ | Radio mode: search for the first radio station that can be tuned at a higher frequency CD mode: selection of the next track Cassette mode: fast tape feed to end of listened track or to next track. TV mode: search for the first channel that can be tuned at a higher frequency | Radio mode: actuation of the “Scan” function with station scanning in the radio band selected starting from the higher frequency ones CD mode: fast forward Cassette mode: fast tape feed |
| 8 | System switching on/off: pressing the knob Volume control: rotating the knob | – |
| 9 – SETUP | System set-up and car functions that can be modified | – |
| 10 – TRIP | Trip computer screen selection | – |
| 11 – AUDIO | Turning on Audio mode and/or selecting specific screen display | Turning off Audio mode (Radio, CC, CD/CDC) |
| 12 – SRC | Audio source selection: FM1, FM2, FM3-AS, MW, LW, CC, CD, CDC, TV | – |
| 13 – MAIN | MAIN screen selection (main screen) | – |

| Legend | Short push (less than 2 seconds) | Long push (more than 2 seconds) |
|--|---|------------------------------------|
| 14 – DARK | DARK mode actuation: the display is completely darkened | – |
| 15 –  | Forwarding the phone call set Accepting the incoming call Ending the ongoing call | Refusing the incoming phone call |
| 16 – TEL | Phone mode actuation and/or specific screen selection | Phone mode off |
| 17 – RPT | Repetition of the last navigator voice instruction | – |
| 18 – NAV | Navigation mode actuation and/or specific screen | – |
| 19 – MAP | Navigator map mode selection | – |
| 20 –  | Access to Targasys services | – |
| 21 | Required function selection by turning the knob. Selected function confirmation by pressing the knob. | – |
| 22 | Remote control receiver | – |
| 23 – ESC | Exit from a selection option or shift from a submenu to a higher menu | – |
| 24 – SIM | Eject SIM telephone card | – |
| 25 –  | Reverse tape side being listened to | – |
| 26 | Slot for SIM telephone card | – |
| 27-28-29-30-31-32 | Double “multifunction” buttons: their functions depend on the system active mode shown on the display. The function associated to the “multifunction” buttons is identified from time to time by a writing on the display, just next to each button In some cases, the writing covers several adjacent buttons: the function associated to all these buttons is the same. Radio/TV mode: select stored stations. CD-changer mode: select CD in the magazine. | Radio/TV mode: station storage |
| 33 | Reset button for system restart | – |

CONTROLS ON THE STEERING WHEEL (fig. 3)

The main CONNECT function controls are duplicated on the steering wheel, thus facilitating its control.

The steering wheel also includes the VOICE button, used to switch the phone/audio system voice controls on/off, and record short voice messages.

The control functions are as follows:

- A** - Voice Recognition:
 - voice recognition on/off: short push
 - voice message memorization: long push
 - voice recorder stop: short push

B - Audio source selection: FM1, FM2, FM3-AS, MW, LW, CC, CD, CDC, TV

C - Turning down the volume

D - Turning up the volume

E - Radio mode: search for the first radio station that can be tuned at a higher frequency

Cassette mode: fast tape feed to end of listened track or to next track

CD/CDC mode: selection of next track

TV mode: channel search in an increasing order

F - Radio mode: search for the first radio station that can be tuned at a lower frequency

Cassette mode: fast tape rewind with return to beginning of listened track or to previous track

CD/CDC mode: selection of previous track

TV mode: search for the first channel that can be tuned at a lower frequency

G - Cyclic selection of main screens
MAIN – AUDIO – TRIP – SETUP – TEL – NAV – CONNECT (access to Targasys services)

H - Phone button:

- accepting the incoming call: short push
- ending the ongoing call: short push
- to display the last dialled number: brief press
- forwarding the call set: short push
- reading the SMS just received: short push
- refusing the incoming call: long push

L - Display function upward selection

M - Selected function confirmation

N - Display function downward selection



fig. 3

REMOTE CONTROL (fig. 4-5)

The infrared-ray remote control controls certain main functions of the TV and audio system.

The remote control can be used only when the CONNECT is switched on.

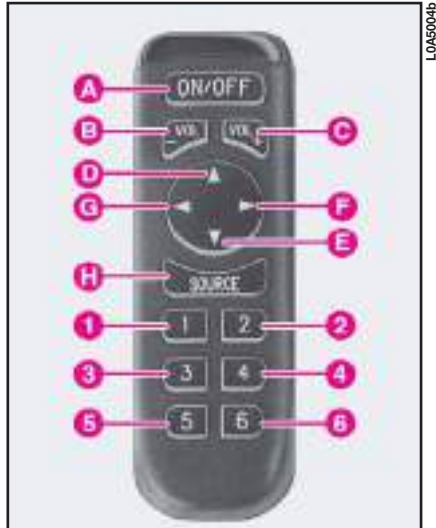

fig. 4

The remote control functions can be switched off and on again by selecting the corresponding item of the SETUP function (set-up).

To use remote control A (fig. 5) take it out from support B.

The remote control buttons perform the following functions (fig. 4):

A - Radio mode: “Audio Mute” function on/off (volume muting) only with TP function active (symbol “√” near TP on the main Radio screen).

CC/CD/CDC mode: play/stop current track.

TV mode: TV off and return to previously active Audio source screen



fig. 5

B - Turning down the volume

C - Turning up the volume

D - Radio mode:

- short push = search for the first radio station that can be tuned at a higher frequency
- long push = actuation of the “Scan” function with scanning of the stations in the selected radio band starting from the higher frequency ones

CD mode:

- short push = selection of next track
- long push = fast forward

Cassette mode:

- short push = fast tape feed to end of listened track or to next track
- long push = fast tape feed

TV mode: search for the first channel that can be tuned at a higher frequency

E - Radio mode:

- short push = search for the first radio station that can be tuned at a lower frequency
- long push = actuation of the "Scan" function with scanning of the stations in the selected radio band starting from the lower frequency ones

CD mode:

- short push = selection of previous track
- long push = fast backward

Cassette mode:

- short push = fast tape rewind with return to beginning of listened track or to previous track
- long push = fast tape rewind

TV mode: search for the first channel that can be tuned at a lower frequency

F - Radio mode:

- short push = search for the first radio station that can be tuned at a higher frequency

- long push = actuation of the "Scan" function with scanning of the stations in the selected radio band starting from the higher frequency ones

CD mode:

- short push = selection of next track
- long push = fast forward

Cassette mode:

- short push = fast tape feed to next track
- long push = fast tape feed

TV mode: search for the first channel that can be tuned at a higher frequency

G - Radio mode:

- short push = search for the first radio station that can be tuned at a lower frequency
- long push = actuation of the "Scan" function with scanning of the stations in the selected radio band starting from the lower frequency ones

CD mode:

- short push = selection of previous track
- long push = fast backward

Cassette mode:

- short push = fast tape rewind to previous track
- long push = fast tape rewind

TV mode: search for the first channel that can be tuned at a lower frequency

H - Audio source selection: FM1, FM2, FM3-AS, MW, LW, CC, CD, CDC, TV

1-2-3-4-5-6 - Radio mode:

- short push = Recall of stored stations no. 1-2-3-4-5-6
- long push = storing the station being listened to

CD-changer mode: CD selection from 1 to 6

TV mode: stored channel selection from 1 to 6

AUDIO AND TV FUNCTION: CONTROL SUMMARIZING TABLE

The TV and audio system (FM/AM radio and Cassette/CD/CDC player) functions can be switched on/off without distinction by means of the controls on the CONNECT, the steering wheel or the remote control. To make it easier getting acquainted with the controls, a table is shown below with the various functions and their respective control buttons.

To use voice commands, refer to the relevant chapter provided in the CONNECT supplement.

| Function | CONNECT buttons | Steering wheel buttons | Remote control buttons |
|--|--|----------------------------|------------------------------|
| Audio module switching on | Short push on AUDIO button | – | – |
| Audio module switching off | Long push on AUDIO button | – | – |
| Audio mute (only with TP active on the main Radio screen) | “Audio Mute” selection and confirmation on Radio menu by the right knob 21 (fig. 2) | – | Press the ON/OFF key |
| Audio source selection | Press the multifunction buttons FM, AM, CC, CD, CDC, TV or the SOURCE button | Press the SOURCE button | Press the SOURCE button |
| Turning the volume up/down | Rotate the left-hand knob | Press VOL+/- buttons | Press VOL+ or VOL- buttons |
| Selection of stored radio stations | Short push on buttons 1 to 6 | – | Short push on buttons 1 to 6 |
| Radio station memorization | Long push on buttons 1 to 6 | – | Long push on buttons 1 to 6 |
| Search for the first radio station that can be tuned at a higher frequency | Short push on button ► | Short push on SCAN+ button | Short push on button ▲ |
| Search for the first radio station that can be tuned at a lower frequency | Short push on button ◀ | Short push on SCAN- button | Short push on button ▼ |

| Function | CONNECT buttons | Steering wheel buttons | Remote control buttons |
|---|---------------------------------------|-------------------------------|-------------------------------|
| Actuation of the “Scan” function with scanning of the stations in the selected radio band starting from the higher frequency ones | Long push on button ► | Long push on SCAN+ button | Long push on button ▲ |
| Actuation of the “Scan” function with scanning of the stations in the selected radio band starting from the lower frequency ones | Long push on button ◀ | Long push on SCAN- button | Long push on button ▼ |
| Reversing cassette tape | Press button ◀► | – | – |
| Fast tape rewind to previous track | Short push on button ◀ | Short push on SCAN- button | Short push on button ▼ or ◀ |
| Fast tape rewinding | Long push on button ◀ | Long push on SCAN- button | Long push on button ▼ |
| Fast tape feed to next track | Short push on button ► | Short push on SCAN+ button | Short push on button ▲ or ► |
| Fast tape feed | Long push on button ► | Long push on SCAN+ button | Long push on button ▲ |
| Play/pause of listened track CC/CD | Push multifunction buttons Play/Pause | – | Push ON/OFF button |
| Search for next track while playing a CD | Short push on button ► | Short push on SCAN+ button | Short push on button ► |

| Function | CONNECT buttons | Steering wheel buttons | Remote control buttons |
|---|-----------------------------|-------------------------------|-------------------------------|
| Search for previous track while playing a CD | Short pressure of button ◀ | Short push on SCAN- button | Short pressure of button ◀ |
| Selection of CD in CDC mode | Press buttons 1 to 6 | – | Press buttons 1 to 6 |
| Play/stop the track being listened to in CDC mode | – | – | Press ON/OFF button |
| Selection of memorized TV channels | Press buttons 1 to 6 | – | Press buttons 1 to 6 |
| Search for next tunable TV channel | Short push on button ▶ | Press SCAN+ button | Short push on button ▲ |
| Search for previous tunable TV channel | Short push on button ◀ | Press SCAN- button | Short push on button ▼ |
| TV module off (return to previously active Audio source screen) | Press OFF multifunction key | – | Press the ON/OFF key |

IGNITION SWITCH

The key can be turned to three different positions (**fig. 6**):

STOP: engine off, key can be removed, steering column locked. Some electrical devices can be operated (e.g. **CONNECT**).

MAR: driving position corresponding to: dashboard on and steering column lock off. All the electrical devices can be operated.

AVV: engine ignition. Release the key as soon as the engine is started.



fig. 6



If the ignition switch has been tampered with (e.g. someone has tried to steal your car), get a Lancia Dealership to make sure it is still functioning properly before you start driving again.



Always remove the ignition key when you get out of the car. This will prevent anyone from accidentally working the controls. Remember to apply the handbrake and, if the car is faced down on a steep slope engage the first gear. If it is facing up, engage the reverse gear.

IMPORTANT For versions equipped with the recognition system, refer to paragraph “Recognition system (Keyless System)” in this chapter.

STEERING COLUMN LOCK

The steering column lock is engaged automatically after removing the ignition key.



It is absolutely forbidden to carry out whatever after-market operation involving steering system or steering column modifications (e.g.: installation of anti-theft Device) that could badly affect performance and safety, cause the lapse of warranty and also result in non-compliance of the car with homologation requirements.

Versions with Keyless System

The steering column lock is engaged when central door locking is actuated by means of the remote control. This condition is indicated on the instrument panel display by message “STEERING LOCKED WHEN DOORS CLOSED”.



The steering column lock is not engaged if central door locking is actuated by means of the emergency key or if central locking is activated automatically (“Autoclose” function).

The steering column lock is disengaged automatically when depressing the clutch pedal (versions with manual gearbox) or brake pedal (versions with automatic transmission).

Steering column lock always off

The user can set the condition “Steering column lock always off” by means of the CONNECT menu. To set this mode, refer to the CONNECT supplement provided with the car.

In an emergency

The steering column lock cannot be disengaged when the battery is run down. In this case, open the bonnet with the emergency key and connect an auxiliary battery to the car battery.



Before opening the luggage compartment bonnet to reload the battery or to connect an auxiliary battery, carefully read and comply with the instructions contained in the paragraph “If battery is to be disconnected” in the chapter “In an emergency”.



Do not carry out this procedure if you lack experience; if it is not done correctly it can cause very intense electrical discharges and the battery might even explode. Contact a Lancia Dealership. In any case, refer to paragraph “Jump starting”.

THE LANCIA CODE SYSTEM

To further protect your car from theft, it has been fitted with an engine immobilising system (Lancia CODE) which is automatically activated when the ignition key is removed. An electronic device, in fact, is fitted in each ignition key grip. The device transmits a radio-frequency signal when the engine is started through a special aerial built into the ignition switch. The modulated signal is a password. Only if the control unit recognises the key can the engine be started.

OPERATION

Each time the ignition key is turned to **STOP** the Lancia CODE system will deactivate the engine electronic control unit functions.

When the key is turned to **MAR** to start the engine, the Lancia CODE system sends a password code to the engine control unit to deactivate the function lock. The encoded and variable code, randomly selected from over four billion possible combinations, is only sent if, in turn, the system has recognised the code transmitted by the electronic device built into the ignition key via an aerial surrounding the ignition switch.

If the code has not been recognised correctly, the symbol  will appear on the instrument panel display, together with the message "VEHICLE PROTECTION SYSTEM FAULT".

In this case, turn the key to **STOP** and then back to **MAR**. If the engine remains immobilised, try with the other keys provided with the car. If you are still unable to start the engine, carry out the emergency procedure described in chapter "In an emergency", and contact your **Lancia Dealership**.

IMPORTANT Each key has its own code that must be stored in the system control unit. For storing new keys, up to a maximum of eight, apply solely to **Lancia Dealership** taking with you all the keys in your possession, the CODE card, a personal identity document and the documents that certify car possession.



The codes of any keys that are not available when the new storage procedure is carried out will be deleted from the memory to prevent any lost or stolen keys being used to start the engine.

IMPORTANT If symbol  lights up when the car is running:

1) If the symbol lights up together with the message “VEHICLE PROTECTION SYSTEM FAULT”, this means that the system is running a self-test (e.g. due to a voltage drop). The first time you stop, you can test the system as follows: switch the engine off by turning the ignition key to **STOP** then turn the key back to **MAR**: the symbol will light up and go out in about 1 second. If the symbol remains on, repeat the above procedure, leaving the key at **STOP** for longer than 30 seconds. If the problem persists, contact your **Lancia Dealership**.

2) If the symbol stays on, this means that the code has not been recognised. In this case, turn the key to **STOP** and then back to **MAR**. If the engine remains immobilised, try with the other keys provided with the car. If you are still unable to start the engine, carry out the emergency procedure (see chapter “In an emergency”), and contact your **Lancia Dealership**.

THE KEY

The car is delivered with two copies of the key **A** (fig. 7) with metal insert and power-assisted opening with built-in remote control for remote door opening/closing, boot/tailgate opening and switching the electronic alarm on/off.



fig. 7

The key operates:

- ignition switch;
- steering column lock disengagement;
- front door lock latches;
- dead lock device;
- remote door opening/closing;
- remote bonnet lock locking/unlocking;
- remote boot lock locking/unlocking;
- remote bonnet opening;
- electronic alarm system;
- passenger side airbag deactivation;
- rear airbag deactivation;
- window and sunroof opening/closing.



The electronic components inside the key may be damaged if the key is exposed to direct sunlight.

By the CONNECT menu, the system can be set in such a way that when the door opening button is pressed, only the driver's door or all the doors are unlocked. To get acquainted with the operation logic of the key with remote control and all the settings that can be modified, refer to the following paragraph "Electronic alarm".

IMPORTANT If the relevant function has been actuated by the CONNECT menu, the boot lock will automatically be released when central door opening is actuated.

Code card

The CODE card (fig. 8) is also supplied with the keys and bears the following:

A - The electronic code, to be used for emergency starting.

B - The mechanical key code to be given to the **Lancia Dealership** when ordering duplicate keys.

C and **D** - The spaces for the electronic alarm remote control stickers.



fig. 8

The code numbers written on the CODE card must be kept in a safe place (not in the car).

You should always have the electronic code number written on the CODE card with you at all times in case you need to perform an emergency start-up.



All the keys and the CODE card must be handed over to the new owner when selling the car.

The key (fig. 9) has:

- metal insert **A** that can be enclosed in the key grip;
- button **B** to open the metal insert;
- button **C** for remote door unlocking and electronic alarm deactivation at the same time;
- button **D** for remote door and boot locking and electronic alarm activation at the same time;
- button **E** for remote bonnet opening;

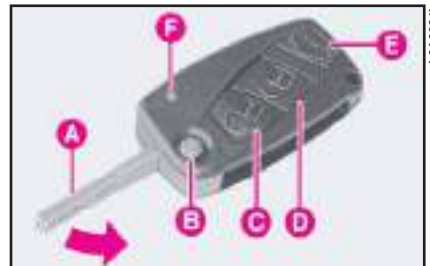

fig. 9

– led **F** (where required) indicating code sending to the electronic alarm system receiver.

Prolonged pressure (more than 2 seconds) of button **C** will actuate the opening of all the door windows and the sunroof, to aerate the passenger compartment: opening is interrupted when the button is released.

Similarly, door windows and sunroof can be closed when closing the doors by pressing down (for more than 2 seconds) the remote locking button **D** until they are completely closed.

Door windows and sunroof closing is interrupted when button **D** is released.

Pressing again the button **D** within 1 second will activate the dead lock device (see paragraph “Doors”).



After activating the dead lock device it will be impossible to get out of the passenger compartment: for this reason this device must be activated only after making sure that the passenger compartment is empty.

The metal insert A (fig. 10) of the key operates:

- ignition switch;
- steering column lock disengagement;
- the front door locks;
- the boot lock;
- the passenger side airbag deactivation switch;
- the rear airbag deactivation switch.

To make the metal insert come out of the key handle, press button B.



Take the greatest care when pressing button B (fig. 10), to avoid that the metal insert A can cause injury or damage when coming out. Button B must be pressed only when the key is far from your body, in particular your eyes, and from objects subject to deterioration (e.g. clothes). Do not leave the key unattended to prevent anyone, especially children, from handling it and pressing button B unintentionally.

To put the metal insert into the key grip, keep button B depressed and rotate the insert in the direction shown by the arrow until hearing the locking click. Then release button B.



fig. 10

Remote control

The remote control is built into the key and has three buttons **C**, **D** and **E** (fig. 9) and a led **F** (where required). The buttons respectively operate the central opening control, the central locking control and the boot lock; the led flashes while the transmitter is sending the code to the receiver. This code (rolling code) changes at each transmission.

To actuate the remote central door opening, press button **C** (fig. 9): the doors will unlock and the indicators will flash twice. To actuate central door locking, press button **D**: the doors will lock and the indicators will flash once.

By pressing button **C**, also the alarm system will be switched off; by pressing button **D**, the alarm system will be switched on and the key led **F** (where required) will flash while the transmitter sends the code to the receiver: this code (rolling code) varies at each transmission.

IMPORTANT When the remote control battery is run down, the dashboard display will show the symbol  accompanied by the message “DISCHARGED REMOTE CONTROL BATTERY”. In this case, it is advisable to replace the battery as soon as possible, by following the instructions given below.

IMPORTANT The remote control operation depends on different factors, such as possible interference with electromagnetic waves emitted by external sources, the battery charge and the presence of metal objects near the key and the car. It is however possible to perform any procedure using the metal insert of the key.

REMOTE CONTROL FUNCTIONS

The remote control allows to control the functions that can be modified directly by the user, through the CONNECT setting menu, or by the **Lancia Dealership**. The following table lists the system options and the settings provided when the car is delivered to the customer.

| Requested function | Action performed on the remote control | Standard settings | Functions that can be modified |
|---|---|---|---|
| Central door opening (double short blink of direction indicators) | Single short pressure of button C (fig. 9) | <ul style="list-style-type: none"> - Electronic alarm switching off - Door and tailgate unlocking - Door deadlock device switching off (if on) - Ceiling light switching in for about 30 seconds or until the key is turned to MAR | <ul style="list-style-type: none"> - Driver's door unlocking - Tailgate always locked |
| | Subsequent double short pressure (within 1 second) of button C | <ul style="list-style-type: none"> - Door unlocking | |
| | Prolonged pressure of button C (more than 2 seconds) | <ul style="list-style-type: none"> - Opening of the windows and sunroof (to complete opening or until the button is released) | |

| Requested function | Action performed on the remote control | Standard settings | Functions that can be modified |
|--|---|--|--------------------------------|
| Central door locking (single prolonged blink of direction indicators) | Single short pressure of button D (fig. 9) | <ul style="list-style-type: none"> – Electronic alarm switching on – Door and boot locking – Ceiling lights switching off | |
| | Subsequent double short pressure (within 1 second) of button D | <ul style="list-style-type: none"> – Door deadlock device switching on | |
| | Prolonged pressure of button D (more than 2 seconds) | <ul style="list-style-type: none"> – Closing of windows and sunroof (to complete closing or until the button is released) – Ceiling lights switching off | |
| Tailgate unlocking and tailgate lifting (double blink of direction indicators) | Single short pressure of button E (fig. 9) | <ul style="list-style-type: none"> – Boot alarm switching off – Tailgate lock unlocking | |
| | Prolonged pressure of button E (more than 1 second) | <ul style="list-style-type: none"> – Boot alarm switching off – Tailgate unlocking and tailgate raising | |

FUNCTIONS THAT CAN BE ACTUATED WITH THE METAL INSERT OF THE KEY

The metal insert of the key allows to control the functions that can be modified directly by the user, by means of the CONNECT setting menu, or by the **Lancia Dealership**. The following table lists the system options and the settings provided when the car is delivered to the customer.

| Requested function | Action performed with the metal insert of the key | Standard settings | Functions that can be modified |
|----------------------|---|---|---|
| Central door opening | Single, clockwise rotation of the key in the lock latch of one of the doors | <ul style="list-style-type: none"> - Door and tailgate unlocking - Door deadlock device switching off (if on) - Ceiling lights switching on for about 30 seconds, or until the key is turned to MAR | <ul style="list-style-type: none"> - Driver's door unlocking - Tailgate always locked |
| Central door locking | Single, anticlockwise rotation of the key in the lock latch of one of the doors | <ul style="list-style-type: none"> - Doors and tailgate locking - Ceiling lights switching off | |

ACTUATION LOGIC OF THE BOOT LOCK BY MEANS OF THE REMOTE CONTROL

| Central door locking system condition | Bound to central door locking | | Not bound to the central door locking | |
|---------------------------------------|---|---|---|---|
| | Off | On | Off | On |
| Operation to open the boot | Press the boot button | Press the remote control button E (fig. 9) then press the boot button or keep the remote control button depressed (more than 1 second) | Press the remote control button E (fig. 9) , then press the boot button or keep the remote control button depressed (more than 1 second) | Press the remote control button E (fig. 9) , then press the boot button or keep the remote control button depressed (more than 1 second) |
| Operation to close the boot | The lock remains unlocked when closing the boot | The lock remains unlocked when closing the boot. For locking the lock, press the remote control button D (fig. 9) | The lock remains unlocked when the boot is closed. The lock is automatically locked when the car speed exceeds 20 km/h approximately | The lock remains unlocked when closing the boot. For locking the lock, press the remote control button D (fig. 9) |

ACTUATION LOGIC OF THE BOOT LOCK BY MEANS OF THE METAL INSERT OF THE KEY

| | Bound to the central door locking | | Not bound to the central door locking | |
|---------------------------------------|---|--|--|--|
| Central door locking system condition | Off | On | Off | On |
| Operation to open the boot | Press the tailgate button | Turn the key clockwise in the lock latch | Turn the key clockwise in the lock latch | Turn the key clockwise in the lock latch |
| Operation to close the boot | The lock remains unlocked when the boot is closed | The lock remains unlocked when closing the boot. For locking the lock, press the remote control button D (fig. 9) | The lock remains unlocked when closing the boot. For locking the lock, press the remote control button D (fig. 9) . In any case, the lock will automatically be locked when the car speed exceeds 20 km/h approximately | The lock remains unlocked when closing the boot. For locking the lock, press the remote control button D (fig. 9) |

OPENING THE TAILGATE

The tailgate can be opened from the outside by pressing the remote control button **E** (fig. 9), even when the electronic alarm is on.

One single short pressure of the button will switch the boot alarm system off and release the lock: the tailgate can therefore be opened from the outside by pressing the boot button. A prolonged pressure (more than 1 second) of the button will switch the boot alarm system off and open the tailgate, which will partially lift.

The opening of the tailgate is accompanied by two direction indicator flashes.

When tailgate opening is actuated, the alarm system disconnects the boot sensor and the direction indicators flash twice (except for the versions of certain markets).

When the tailgate is closed again, press button **D** (fig. 9) to restore locking and control functions; the direction indicators will flash twice (except for the versions of certain markets).

If the tailgate is not open within 30 seconds after actuating the boot unlock control, the tailgate lock will be re-locked and the alarm system will be reactivated.

AUTOMATICALLY ACTUATED FUNCTIONS

The system automatically controls the following functions (settings that cannot be modified):

- boot locking if, within 30 seconds after boot unlocking, it will not be opened;
- possible unlocking of all the door locks, in case of impact with actuation of the inertia switch;
- lock release and tailgate opening (actuated by the button inside the car);
- door opening/closing by the buttons inside the car;
- disconnection of all services when the key is turned to **STOP**, excluding sound system, window regulators, sunroof and internal lighting until doors are opened;
- progressive switching on/off of internal lights;
- light indication of boot open/closed.

KEY BATTERY REPLACEMENT

If the remote control battery is run down, the symbol  will appear on the instrument display, together with the message “DISCHARGED REMOTE CONTROL BATTERY”. In this case, the battery must be replaced with a new one of the same type that can be purchased at common stores.



Used batteries pollute the environment. Dispose of them in the special containers as specified by current legislation. Keep batteries away from open flames and high temperatures. Keep away from children.

To replace the battery:

- press button **B** (fig. 11) and move the metal insert **A** to open position;
- remove the small cover **C** (fig. 12) by levering at point **D**.
- replace battery **E** (fig. 13) by placing it with the pole (+) facing upwards;
- refit the small cover by pressing it.



fig. 11



fig. 12



fig. 13

REQUEST FOR ADDITIONAL KEYS WITH REMOTE CONTROL

The receiver will acknowledge up to eight keys with remote control. If you ever need a new key with remote control, go directly to a **Lancia Dealership**, taking with you the CODE card, personal identification and the car ownership papers.

ELECTRONIC ALARM

The system consists of:

- radio-frequency transmitter (built into the ignition key);
- radio-frequency receiver;
- electronic control unit with built-in siren (the siren can be deactivated);
- volumetric sensors (which can be deactivated);
- anti-lifting sensor (which can be deactivated).

The electronic alarm is controlled by the receiver and is switched on/off by means of the remote control built into the key, which sends the secret and variable code.

The electronic alarm monitors:

- the illicit opening of doors, bonnet and boot (perimetral protection);
- ignition switch operation;
- cutting of battery cables;
- moving bodies inside the passenger compartment (volumetric protection)
- any abnormal raising/sloping of the car.

IMPORTANT The engine immobilising system is governed by the Lancia CODE system and is automatically activated when the ignition key is removed.

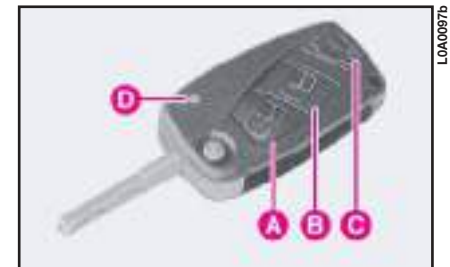



fig. 14

SWITCHING THE ALARM ON

With the doors and boot closed and the key removed from the ignition switch, point the key with the remote control in the direction of the car, then press and release the button **B** (fig. 14).

With the exception of certain markets, a beep will be heard, the direction indicators will light up for about 1 second and the doors will be locked.

The alarm activation is preceded by a self-test: if a fault is found, the system sounds another warning beep and when the key is turned to **MAR**, the symbol  will appear on the instrument panel display, together with the message “ALARM FAULT”.

IMPORTANT When operating the central door locking with the metal insert of the key, the alarm is not activated.

Surveillance

After activating the alarm, the red deterrent leds **A** (fig. 15) on the front door panels will flash to indicate that the surveillance function is on. The leds will stay on flashing until the alarm system surveillance function is on.

IMPORTANT The electronic alarm operation is adapted to the rules in force in the various countries.



fig. 15

Self-test and door/bonnet/boot control functions

If, after switching the alarm system on, a second beep is heard, switch the system off by pressing button **A** (fig. 14), and check that the doors, bonnet and boot are correctly closed. Then switch the system on again by pressing button **B**.

Otherwise the system will cut out the door bonnet and boot from the surveillance if they are not properly closed.

If the doors, the bonnet and the boot are properly closed and a second beep is heard again, it means that the system self-test function has found a fault. Contact a **Lancia Dealership**.

SWITCHING THE ALARM OFF

To switch the alarm off, press the key button **A** (fig. 14).

The following actions will be carried out by the system (with the exception of certain markets):

- the direction indicators will flash twice;
- two beeps will be heard;
- driver's door or doors unlocking, depending on the setting selected on the CONNECT menu.

IMPORTANT When operating the central door unlocking with the metal insert of the key, the alarm is not deactivated.

VOLUMETRIC PROTECTION

Do not leave passengers or pets in the parked car and completely close the windows and the sunroof to ensure the correct operation of the volumetric sensors. Furthermore, make sure that the doors, bonnet and boot/tailgate are properly closed.

To deactivate the volumetric protection, press button **A** (fig. 16) on the front ceiling light: when the function is off, the button warning light will flash for about 3 seconds and then goes out.

Protection cut out stays on until activating the central door opening again.

IMPORTANT Volumetric protection shall be deactivated after about 1 minute from turning the key to **STOP**. To deactivate the volumetric protection after this period, turn the key to **MAR** and then to **STOP** again.



To ensure correct operation of the volumetric protection system, before activating the alarm, check that windows and sunroof (where provided) are perfectly closed.

ANTI-LIFTING SENSOR

The anti-lifting sensor detects variations in slant to signal lifting or partial lifting (e.g. to remove a wheel) of the car.

The sensor can detect minimal variations in cat trim along both the longitudinal axis and the transversal axis. Variations in trim lower than 0.5°/min. (such as, for example, a slow deflating tyre) are not take into account.

To switch the anti-lifting protection off, press button **B** (fig. 16) on the front ceiling light: when the function is off, the button warning light will flash for about 3 seconds and then goes out.

IMPORTANT The anti-lifting sensor shall be deactivated after about 1 minute from turning the key to **STOP**. To deactivate the anti-lifting sensor after this period, turn the key to **MAR** and then to **STOP** again.

Sensor cut out stays on until activating the central door opening again.

WHAT TRIGGERS THE ALARM OFF

The alarm will be triggered off in the following conditions:

- if a door, the bonnet or the boot/tailgate is opened;
- if the battery or electric cables are disconnected or cut;
- if there is an intrusion in the passenger compartment, e.g. a broken window (volumetric protection);
- if an attempt is made to start the engine (key at **MAR**);
- if an attempt has been made to lift the car.

According to the markets, the alarm can operate the siren and the direction indicators (for about 25 seconds). The intervention modality and the number of cycles can vary according to the markets.

A maximum number of acoustic/visual cycles is foreseen in all cases.

After the alarm cycle, the system returns to its normal surveillance function.

INDICATIONS OF ATTEMPTS TO BREAK IN

The alarm system indicates the attempts to break in stored by the control unit, through the lighting up on the instrument panel display of symbol  together with the message “BREAK IN ATTEMPT”.

DEACTIVATING THE ALARM

To completely deactivate the electronic alarm (for example, if the car is to be stored for a long period of time), simply lock the car turning the key in the lock.

FUNCTIONS THAT CAN BE DEACTIVATED OR MODIFIED

The functions that can be directly deactivated:

– volumetric protection, which can be disconnected by means of button **A** (fig. 16) set on the front ceiling light: when the function is off, the button warning light flashes for about 3 seconds and then goes out;

– anti-lifting protection, which can be disconnected by means of button **B** (fig. 16) set on the front ceiling light: when the function is off, the button warning light flashes for about 3 seconds and then goes out.



fig. 16

The functions that can be modified through the CONNECT system menu are:

- boot lock release by actuating central door opening (*);
- central door and tailgate locking when the car speed exceeds 20 km/h, without actuation of the deadlock device.

(*) When this function is disconnected to lock the boot lock when the boot is closed, even if the doors were closed, the remote control or the key must be used, as it is normally the case with the doors; thus, the boot can be opened with the handle in the event that the key is left inside the lock.

MINISTERIAL HOMOLOGATION

In the respect of the legislation in force in each country in the matter of radio-frequency devices, please note that the homologation number is printed on the component for markets where this is required.

IMPORTANT The code marking may also be printed on the transmitter and/or the receiver for versions/markets where this is required.

EASY ENTRY/EXIT SYSTEM

Versions provided with electric steering wheel adjustment may also incorporate the Easy Entry/Exit system, which allows the driver to get into and out of the car with improved ease.

In the cars provided with this system, the steering wheel lifts and the seat goes back before the driver gets out of the car.

The function is actuated when the door is opened but only if the ignition key is at **STOP** or has been removed.

When the driver opens the door to get into the car, both the seat and the steering wheel have already gone back. The seat and the steering wheel will return to their normal driving position after the driver has sat, closed the door and turned the key to **MAR**.

RECOGNITION SYSTEM (KEYLESS SYSTEM)

(where provided)

The Keyless System is a recognition system controlled by device **A** (fig. 17), called CID (Customer Identification Device), which performs the same functions as the key provided with the remote control supplied with the car. It does not require any manual action since it identifies the person that holds the device as the owner of the car.

Therefore, it is enough for the driver to bring the CID device with

himself so that the car can recognize him, allowing him to get into the car and start the engine without having to use the key.

In any case, the CID device is equipped with three buttons performing the same functions as the ordinary radio-frequency remote control that enable the driver to remotely operate on the car. Moreover, it includes the key for the mechanical emergency actuation of the boot and door locks (in case the CID device battery or the car battery are run down).

The buttons perform the following functions (fig. 18):

- button **B** for remote actuation of central door opening and the simul-

taneous switching off of the electronic alarm

- button **C** for remote actuation of central door locking, boot locking and the simultaneous switching on of the electronic alarm

- button **D** for remote tailgate opening

- led **E** (where required) to indicate code sending to the electronic alarm system receiver.

To remove emergency key **F** (fig. 19), take off cover **G** (fig. 20) by levering at point **H**.



fig. 17



fig. 18



fig. 19

The emergency key actuates:

- the front door locks
- the boot lock
- the passenger’s airbag deactivation switch
- the rear side bag deactivation switch.

The CID device check is carried out when the button inside the door handle or on the boot is pressed: if the Keyless System recognizes the CID device, it disconnects the alarm system and actuates the boot or door opening mechanism.

Identification occurs only if the CID owner is standing about 1 metre far from the door that has to be opened or from the boot.

IMPORTANT The CID device operation depends on several factors, such as the possible interference with electromagnetic waves emitted by external sources, the battery charge and the presence of metal objects near the CID device and the car. In any case, operations can be carried out by means of the emergency key included in the CID device.

To switch off the front passenger’s airbag and the rear side bags, use the emergency key included in the CID device.

The CID owner must take the following precautions to be able to have all the system functions available:

- For unlocking doors or boot, the CID device must be outside the car at a maximum distance of approx. one meter from the handle involved.
- To actuate the ignition switch functions, the CID device must be inside the car.
- If the CID device is taken away from the car (e.g. it is kept inside a bag or in a pocket) the doors cannot be locked and the car started any more.
- If central locking has been activated from inside the car by pressing the button on the driver’s door panel, it will only be possible to get into the car by pressing the button on the CID device.



fig. 20



It is advised to always carry about with you the CID device, avoiding to leave it unguarded inside the passenger compartment, because in this case any children remaining unguarded inside the car or unauthorised people could start the engine.



Do not expose the CID device to electromagnetic fields or high-intensity radio frequency sources, to avoid operation anomalies. Heavy shocks or exposure to direct sunlight could damage the electronic components of the device.

IMPORTANT Do not lay the CID device outside the car on the sunroof, to avoid a fake identification of the CID itself as if inside the car. It is recommend to carry about with you the CID device (e.g. into a pocket).

“GARAGE” POSITION (EMERGENCY ACTUATION)

During emergency or servicing operations, the CID device shall be housed in the dashboard central oddment compartment A (fig. 21) in front of the gear lever.

The electronic component in the CID device is of the “passive” type and does not require dedicated power supply; it can therefore operate in “garage” position even if the CID device battery is run down.



fig. 21

IMPORTANT Do not remove the battery from the CID device until when its replacement is possible.

Where system is unable to identify the CID device (e.g. the CID battery is flat) the car can be accessed by using the emergency key existing inside the CID itself.

When switched on, the alarm system will be actuated when the door is opened and the siren will start sounding but will be switched off by turning the starting knob to **MAR**.

Car start-up will moreover be possible by positioning the CID into the special seat A (fig. 21), located in front of the gear lever. Under these conditions, such compartment is the only position capable of acknowledging the presence of a CID device inside the passenger compartment.

For an emergency engine start up proceed as follows:

- Lay the CID device into the emergency seat **A** (**fig. 21**)
- Push on the clutch pedal (manual gearbox versions) or on the brake pedal (automatic gearbox versions)
- To turn on the instrument panel, turn knob **A** (**fig. 22**) to position **MAR**.

To start engine, turn the knob **A** (**fig. 22**) to position **AVV**, and release as soon as the engine is started.

When the car is running, the engine gets going even if the CID device has been removed from the “garage” position. In any case, the CID device will have to be put back to the “garage” position for subsequent start-up.

IMPORTANT Set free from any object compartment **A** (**fig. 21**), before starting the emergency engine start-up procedure.

IMPORTANT Remember to carry about with you the CID device before moving away from the car.

KNOB FOR ACTUATING INSTRUMENT PANEL AND ENGINE START-UP

The car is fitted with a switch controlled by knob **A** (**fig. 22**), enabling to actuate **STOP**, **MAR** and **AVV** starter motor switch functions.

IMPORTANT Knob rotation is enabled by the presence of the CID device in the car and by the pressing of the clutch pedal (or the brake pedal for cars with automatic transmission).

STOP position

This position of the switch knob corresponds to: engine off and steering column lock on. Certain electrical devices (e.g. **CONNECT**) can be operated.



fig. 22

MAR position

This is the running position and corresponds to: instrument panel on and steering column lock off. All the electrical devices can be operated.

AVV position

This is the position for engine start-up: release the knob as soon as the engine has started. The engine can be started only when the CID device is inside the car.

IMPORTANT System checks for the presence of a CID device inside the passenger compartment, whenever a door or the luggage compartment are closed, while the instrument panel is turned on or the engine is running. If the CID device is not identified, e.g. because the CID owner leaves the car, the display on the instrument panel will display the message: “ELECTRONIC KEY NO LONGER PRESENT IN THE CAR – ENGINE CANNOT BE RESTARTED”. The engine will keep on running and instrument panel will remain on, until the suc-

cessive rotation of knob **A** (fig. 22) to the **STOP** position, and it will not be possible to restart the car until a valid CID device is identified inside the passenger compartment.

IMPORTANT Make sure the CID device is not positioned in places difficult to be accessed by the identification system, such as the instrument panel, the car floor or the shelf below the rear window. Some electronic devices (e. g. mobile phones, PDA, etc.) can moreover influence the CID device identification. In the case where, after a start-up operation, the message “ELECTRONIC KEY NOT IDENTIFIED” should be displayed, on the instrument panel, make sure make sure whether the CID is present into the passenger compartment and it is located in places that can be reached by identification system.

IMPORTANT If the CID device is inside the luggage compartment, it is possible that the engine could not be started.

Engine stop

To switch the engine off, turn the knob from **MAR** to **STOP**: the engine will stop and the instrument panel will display the message “STEERING LOCKED WHEN DOORS CLOSED”.

Steering column locking

The steering column lock is automatically switched on by actuating door closing by means of the remote control, if the system has detected the simultaneous presence of the following conditions:

- engine off (knob rotation to **STOP** with the car at a standstill)
- clutch pedal released (brake pedal released on versions with automatic transmission).

IMPORTANT The steering column lock is not switched on when the door locks are actuated by means of the emergency key in the CID device, or automatically when the CID device is taken away from the car.

IMPORTANT User is not authorised to move the car if the start-up knob is not turned to the position **MAR**. Should it be necessary to tow the car, it is advised to turn the knob to the **MAR** position before moving the car.



Before leaving the car in a car-wash tunnel, disengage the parking brake by following the instructions described in the relevant paragraph, and leave the CID device inside the passenger compartment, to avoid automatic steering column lock.

Steering column unlocking

The steering column is automatically switched off, and the instrument panel and electrical services switched on, when the system detects the simultaneous presence of the following conditions:

- CID device inside the car
- clutch pedal depressed (brake pedal on versions with automatic transmission).

IMPORTANT If the car battery is run down, the steering column cannot be unlocked and the car cannot be started. In this case, an auxiliary battery must be connected, in order to unlock the steering column and start the engine (see paragraph “Jump starting”); then, contact a **Lancia Dealership** to have the battery recharged.



fig. 23

DOOR UNLOCKING TO ACCESS CAR

To perform door unlocking, push on button **A** (fig. 23 front doors - fig. 24 rear doors) in the inside part of handles. The Keyless System identifies the CID device, deactivates the electronic alarm system and operates the door/s unlocking mechanism. Leds on door panels will be lit to a green colour to notice unlocking.

It is possible to set unlocking of driver's door only or the contemporary unlocking of all the doors, by the settings on CONNECT (see the following paragraph “System Settings”). If “driver's door unlocking” is set, it will be possible to access the passenger compartment only through this door; to unlock the other doors push on button **B** (fig. 18) on CID device.

IMPORTANT If car or CID device batteries are flat, to unlock the door lock it is necessary to operate on the revolving plug with the emergency key **F** (fig. 19).

IMPORTANT If the door lock has been closed with the emergency key **F** (fig. 19), Keyless System functions will temporarily disabled. These functions will automatically be restored at the next unlocking by pushing button **B** (fig. 18) on the CID device or after the unlocking with the emergency key **F** (fig. 19).



fig. 24

LOCKING THE DOOR AND LEAVING THE CAR (with the identification system disabled)

To lock doors when system functions are disabled, proceed as follows:

- Close all the doors and the luggage compartment bonnet
- Push on button **C (fig. 18)** on CID device to engage central locking of doors, of luggage compartment and of electronic alarm.

Leds on door panels will lit for approx. 3 seconds in red colour and then they will start flashing with deterring function.

If one or more doors are not correctly closed, leds will start flashing for 3 seconds instead of being lit with a fixed light. After flashing for 3 seconds, leds will anyhow be turned out, except for that on the driver's door, which will start flashing with a deterring function.

TAILGATE OPENING

If the boot shall be opened from outside, with the doors locked, it is enough to get near the boot with the CID device and press the boot button: the boot lock will release and the boot will be opened while the doors remain locked. If the alarm system is on, the boot protection, volumetric protection and anti-lifting protection will be temporarily excluded.

When the boot is reclosed, it will have to be locked by pressing the door locking button on the CID device, which will resume the alarm protection, too.

IMPORTANT Before closing the luggage compartment bonnet, make sure you always have with yourself the CID device.

AUTOCLOSE FUNCTION (AUTOMATIC LOCKING OF DOORS, BOOT, AND FUEL FILLER FLAP)

The Keyless System automatically locks the boot and door locks when the owner goes away with the CID device at least 4 metres far from the car. Boot and door locking is confirmed by the flashing of direction indicators.

This function can be switched off by acting on the CONNECT settings.

The Autoclose function is not actuated in the following cases:

- If, when the driver moves away from the car, one or several doors are not closed correctly, automatic locking will not be actuated and the car doors and boot will remain open: the owner is warned of this by the failed blinking of direction indicators.

- If at the time of moving away, other CID devices are identified as existing in the car passenger compartment or in the luggage compartment, or if the knob is not set to the **STOP** position (instrument panel turned on or engine started).

- If there is a fault in the identification system (Keyless System).
- If the CID device battery is flat.
- If the last engine start-up was performed with the CID device in the emergency position.

IMPORTANT

- If, after locking the locks, a door is opened from inside the car, all the locks will be unlocked.
- If central door opening has been activated by pressing the CID button, the Autoclose function (automatic locking) will not be activated. To activate central locking, press the relevant button on the CID device.
- When the Autoclose function on, before leaving the car, make sure you always have with yourself the CID device.

The Autoclose function can be influenced by the presence of electromagnetic noises; in these cases lock the doors with the remote control or use the door locks.



The alarm system, the steering lock and the deadlock device are not actuated by the automatic locking function.

IMPORTANT Purpose of Autoclose function is to lock doors, luggage compartment and fuel filler flap when owner possessing the CID device, moves away from the car. In this case (Autoclose function on), push on button **B** (fig. 18) on CID to unlock fuel filler flap in order to refuel.

CENTRAL LOCKING/OPENING OF WINDOWS AND SUNROOF

When central door locking is switched on/off, also the central locking/opening of the windows and the sunroof can be controlled, provided that all the doors are properly closed.

To actuate central locking of the windows and the sunroof, keep the remote control button **A** (fig. 25) depressed for more than 2 seconds after closing the doors: both the window regulators and the sunroof will be actuated until they are fully closed or until the button is released.



fig. 25

To actuate central opening of the windows and sunroof, keep the remote control button **B** (fig. 25) depressed for more than 2 seconds after opening the doors: both the window regulators and the sunroof will be actuated until they are fully opened or until the button is released.

This function can be used to aerate the passenger's compartment before getting into the car parked in the sun.

IMPORTANT Do not lay the CID device outside the car on the sunroof, to avoid a fake identification of the CID itself as if inside the car. It is recommend to carry about with you the CID device (e.g. into a pocket).



Before and during automatic actuation of the window regulators and sunroof, always make sure that the passengers and the persons standing near the car are not exposed to the risk of injuries that may be caused either by the moving windows and sunroof or by objects dragged or hit by the same.

SYSTEM SETTINGS

The CONNECT enables to customize certain functions of the Keyless System recognition system, through the settings that can be selected on the CONNECT display.

The “central unlock” and “driver's door unlock” functions of the central locking can be set also for the Keyless System and operate as follows:

- central unlock: all the car doors are unlocked simultaneously and access is possible through every door
- driver's door unlock: access is possible through the driver's door whereas the other doors remain locked, thus preventing unauthorized persons from getting into the car. In this case, the led on the driver's door panel lights up (green colour) whereas the leds on the other doors remain off.

When “unlocking driver's door” is set, it is anyhow possible to unlock all the doors, to enable access to passengers, by pushing button **B** (fig. 18) on CID device or, after opening the driver's door, by pushing the central unlock button existing on the door panel.

The other recognition system settings that can be enabled/disabled are:

- automatic locking of doors and boot.

As regards the setting of the recognition system customizations, refer to the CONNECT supplement.

FAILURE INDICATION

The presence of anomalies in the Keyless System is indicated by the lighting of symbol  on the instrument display, together with the message “VEHICLE PROTECTION SYSTEM FAULT”.

IMPORTANT In case of fault, contact your **Lancia Dealership**.

REQUEST FOR ADDITIONAL CID DEVICES

The Keyless System receiver can recognize up to 4 CID devices.

If you have requested additional CID devices, remember that the programming operation must be carried out simultaneously for all the CID devices.

Therefore, should a new CID device be necessary for whatever reason, go to your **Lancia Dealership**, bringing with you all the keys and CID devices in your possession, the CODE card, your ID card and the documents that certify car possession.

MINISTERIAL HOMOLOGATION

In the respect of the legislation in force in each country in the matter of radio-frequency devices, please note that for markets where transmitter marking is requested, the homologation number is printed on the CID device.

The code marking may also be printed on the CID and/ or the receiver for versions/markets where this is required.

CID DEVICE BATTERY REPLACEMENT

If the CID device battery is almost flat, system performance worsens. In this case, the battery must be replaced with a new one of the same type that can be purchased at common stores.



Used batteries pollute the environment. Dispose of them in the special containers as specified by current legislation. Keep batteries away from open flames and high temperatures. Keep away from children.



fig. 26

To replace the battery:

- remove the small cover **A** (fig. 26) by levering at point **B**
- take out the emergency key **C** (fig. 27)
- replace the battery **D** (fig. 28) inserting it with the pole (+) facing upwards
- refit the emergency key
- refit the small cover by pressing it.

IMPORTANT It is advised to avoid touching the electric contacts existing inside the CID and to prevent their contact with liquids or dust.

IMPORTANT Although the presence of electromagnetic waves is not harmful to the CID device, it can nevertheless influence battery life cycle. Avoid therefore to leave the CID for a long time near electronic devices (e.g. PC monitors, TV sets, etc.).

IMPORTANT Electronic devices (e.g. mobile phones, PDA, etc.) can influence the correct identification of the CID device by the Keyless System. It is advised to keep the CID device apart from such devices, e.g. into different pockets.

DOORS



Before opening a door, check whether this operation can be performed under safety conditions.

OPENING/CLOSING FROM THE OUTSIDE

With the doors closed, either press button **A** or **B** (fig. 29) on the key grip or insert and turn the key (fig. 30) in one of the front doors.



fig. 27



fig. 28

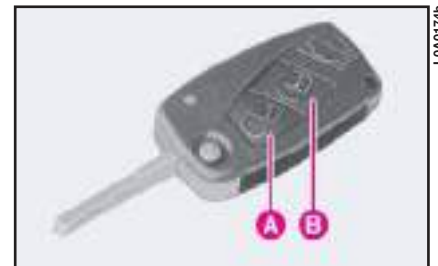

fig. 29

To unlock, turn the key clockwise **1**; to lock, turn the key counter-clockwise **2**.

When the doors are released by means of the remote control, the alarm system and the deadlock device (described below) are also switched off.

IMPORTANT The electronic alarm will not be switched off if the door is unlocked by the key in the lock.

Inside each handle there is a button **A** (fig. 31 front doors - fig. 32 rear doors) which actuates, when the handle is caught, the servo control used to open the door.



fig. 30

The car is fitted with power locks that control the mechanical parts at door opening.



fig. 31



fig. 32

In an emergency (flat battery or electric system failure), doors can be opened, with the locks released, by pressing button **B** (fig. 31 front doors - fig. 32 rear doors).

All door panels incorporate a red/green led **A** (fig. 33 front doors - fig. 34 rear doors), indicating the locking/unlocking condition. The leds come on with red light for about 3 seconds after door locking and with green light after unlocking.

IMPORTANT Door leds stay on for about 3 seconds only; therefore, leds are off under normal conditions.



fig. 33

The front door leds are also used as deterrent leds for the alarm system; as a consequence, they will flash when the alarm system is on or the doors are locked.

The CONNECT enables to set the central locking of all the doors or only the driver's door.

In the former case, all the car doors are unlocked simultaneously and access is possible through any door. In the second case, access is possible only through the driver's door, whereas the other doors are locked, thus preventing un-authorized persons from getting into the car.



fig. 34

In this case, the driver's door led comes on with green light, whereas the leds on the other doors will remain off.

When only the driver's door is unlocked, after opening the driver's door, also the other doors can be unlocked by pressing the central unlocking button **B** (fig. 35) so as to enable passengers getting into the car.

IMPORTANT Buttons **B** and **C** (fig. 35) are disabled when the doors are locked from the outside.

If, when the doors are closed from the outside, one or more doors and/or the boot are not closed correctly, the direction indicators will flash rapidly for a few seconds.



fig. 35

Deadlock device

The deadlock device enables to disconnect mechanically the internal door handles; in this case, doors cannot be opened from the inside by acting on the handles after breaking the glass (improving protection against theft).

The device can be switched on by pressing the remote control button **B** (fig. 29) again within 1 second after closing the doors: active function will be indicated by a beep and 2 further blinks of the direction indicators.

The device activates only if all the doors are properly closed.

When the deadlock device is switched on, the door panel leds will flash twice with red light.



After activating the deadlock device it will be impossible to get out of the passenger compartment: for this reason this device must be activated only after making sure that the passenger compartment is empty.



With the dead lock device on, pressing the external handle button of one of the doors while unlocking the doors by the remote control could cause the disconnection of the internal handle of the involved door thus making impossible to open that door from the inside. To restore regular operation, just press the remote control central door unlocking button or button B (fig. 36) on the door panel.

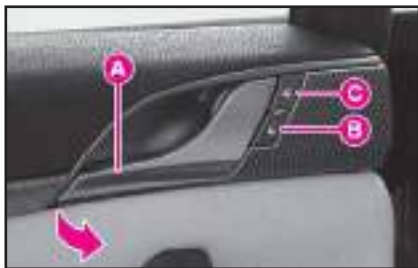

fig. 36

OPENING/CLOSING FROM THE INSIDE

To open the door even when the lock is locked, pull handle A (fig. 35 front doors - fig. 36 rear doors) set in the upper part of the panel.

Next to each door handle are two buttons that actuate lock locking/unlocking:

- B button for unlocking;
- C button for locking.

The red/green leds A (fig. 33 front doors - fig. 34 rear doors) indicate the locking/unlocking condition. The leds come on with red light for about 3 seconds after door locking and with green light after unlocking.

By pulling the internal handle of the driver's door, all the doors or only the driver's door will be simultaneously unlocked, depending on the setting selected on the CONNECT. By pulling the internal handle of any other door, all the doors are simultaneously unlocked.

A led is located near each door handle to make it easy to find the handle in the dark. The leds light up for about 2 minutes after turning the ignition key to **STOP** or until a door is opened.

Door open indication

The driver is informed that one or several doors are not closed correctly by the lighting of the corresponding symbols on the instrument display, together with the messages "DOOR OPEN" or "DOORS OPEN".

Disabling rear door locking/unlocking controls

To disable rear door locking/unlocking controls, press the driver's door button **A** (fig. 37) for more than one second. When controls are off, the button warning light will come on.

To restore controls, press button **A** again. When controls are enabled, the button warning light is off.



fig. 37

CHILD LOCK

To prevent opening the rear doors from the inside.

Engage by inserting the tip of the ignition key in **A** (fig. 38) to turn the lock.

Position **1** - engaged.

Position **2** - disengaged.

The device will be engaged even if the doors are unlocked by means of the centralised system.



fig. 38

IMPORTANT After engaging the lock, check by trying to open a rear door with the internal handle.



Always use the lock when transporting children. This will prevent them opening a door by themselves when travelling.

AUTOMATIC DOOR LOCKING WHEN SPEED EXCEEDS 20 KM/H

The CONNECT enables to set automatic locking of doors, boot and fuel cap when the car speed exceeds 20 km/h.

To actuate these settings, refer to the CONNECT supplement provided with the car.

AUTOCLOSE FUNCTION (AUTOMATIC LOCKING WITH KEYLESS SYSTEM RECOGNITION SYSTEM)

On versions equipped with Keyless System, the “Autoclose” function can be actuated/deactivated through the CONNECT settings. This function makes it possible to automatically lock the boot and doors when the CID device is taken away from the car.

When leaving the car, if one or more doors are not closed correctly, the car will remain open and a further beep will sound to indicate that the locks have not been locked.

The “Autoclose” functions actuates neither the alarm system nor the door deadlock device (refer to the contents of the relevant paragraph). In any case, these functions can be actuated by means of the remote control.

LOCK RELEASE IN CASE OF ACCIDENT

In case of collision with actuation of the inertia switch, the door locks are automatically released to allow rescuers to get access to the passenger compartment.



The external mechanical connections are active only when the doors are unlocked.

In the event that the driver has actuated central locking from the inside and, after a collision, the inertia switch has not actuated the automatic door unlocking function due to the loss of or damage to the battery, access to the passenger compartment will not be possible from the outside.



In any case, door opening from the outside depends on the door conditions after the collision: deformed doors cannot very often be opened even if the lock is released. In such a case, try to open the other doors.

INITIALISING THE DOOR LOCKING CONTROL UNIT

Whenever the battery is electrically connected again or it is reloaded after being completely flat or after replacing one of the protection fuses, to restore the correct operation of the door locking, of air conditioning and of ESP system, it is necessary to perform the initialisation operations contained in the paragraph “If battery is to be disconnected” in the chapter “In an emergency”.

FRONT SEATS



Only adjust the driver's seat when the car is stationary.



Upholstery of your car has been designed to withstand wear deriving from common use of the car. You are however recommended to avoid strong and/or continuous scratching with clothing accessories such as metallic buckles, studs, Velcro fastenings and the like, since these items cause circumscribed stress of the cover fabric that could lead to yarn breaking, and damage the cover as a consequence.



fig. 39

MANUALLY ADJUSTABLE SEATS (Moving the seats backwards or forwards) (fig. 39)

Lift lever A and push the seat forwards or backwards: you are in the correct position for driving when your hands are resting on the steering wheel rim and your arms are slightly bent.



Once you have lever released the lever, check that the seat is firmly locked in the runners by trying to move it back and forth. Failure to lock the seat in place could result in the seat moving suddenly and dangerously.



fig. 40

ELECTRICALLY ADJUSTABLE SEATS

Electric adjustment of seats is possible under one of the following conditions:

- ignition switch to **MAR**
- for approx. 1 minute after removing the ignition key or turning it to **STOP**
- for approx. 3 minutes with key removed or turned to **STOP** and with door open.

The seat adjustment controls are:

fig. 40 - Manually adjustable seats - back and forth adjustment

A - Height adjustment

B - Back rest angle

C - Lumbar adjustment.

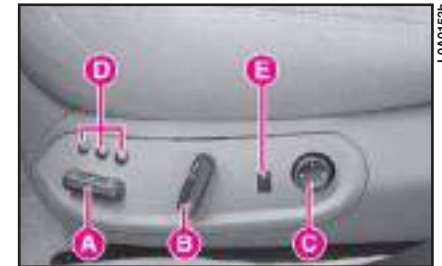

fig. 41

fig. 41 - Electrically adjustable seats, position memorization and heating

A - Height and back and forth adjustment, reclining

B - Back rest angle and head restraint position

C - Lumbar adjustment

D - Seat position memorization buttons

E - Heating.

Seat position adjustment - control A (fig. 40)

- 1 - Seat raising
- 2 - Seat lowering.



fig. 42

Seat position adjustment - control A (fig. 42)

- 1 - Front raising
- 2 - Rear raising
- 3 - Height adjustment
- 4 - Backwards and forwards adjustment.

Seat back position adjustment - control B (fig. 40)

- 3 - Seat back raising
- 4 - Seat back lowering.

Seat back position adjustment - control B (fig. 43)

- 5 - Seat back raising
- 6 - Seat back lowering.



fig. 43

Head restraint position adjustment - control B (fig. 43)

- 7 - Head restraint raising
- 8 - Head restraint lowering.

Lumbar adjustment

This device makes it possible to vary the back support and improve comfort. Press the front part of the button to increase the support and the rear part of the button to decrease it.

Certain seats are also fitted with back height adjustment: press the front part of the button to increase the support and the rear part of the button to decrease it.

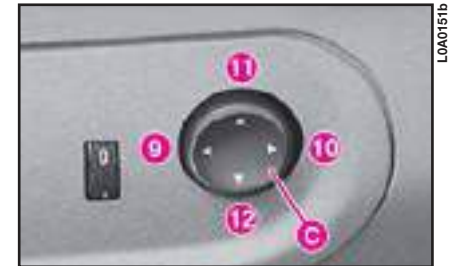

fig. 44

Control C (fig. 40)

- 5 - Lumbar support increase
- 6 - Lumbar support decrease

Control C (fig. 44)

- 9 - Lumbar support increase
- 10 - Lumbar support decrease
- 11 - Vertical support increase
- 12 - Vertical support decrease.

HEATING (fig. 45)

To switch seat heating on, rotate control E to one of positions “1”, “2” or “3” corresponding to the different heating intensity levels. To switch seat heating off, rotate control E to position “0”.



fig. 45

STORING THE DRIVER'S SEAT POSITIONS (fig. 46)

The system allows to store and recall three different driver's seat positions and external rear view mirror positions.

Seat position memorization also includes the head restraint adjustment in height, the position of the external rear view mirrors and of the steering wheel (only versions with electric adjustment).

The seat, external rear view mirror and steering wheel positions can only be stored when the ignition key is at **MAR**.



fig. 46

Adjust the position of the seat, head restraint, external rear view mirrors and steering wheel by means of the relevant controls, then press for about 3 seconds any of buttons “1”, “2” or “3” each corresponding to one stored position, until a confirmation beep is heard.

When memorising the seat positions, also the head restraint, electric rear view mirror and steering wheel positions are memorised.

The previously stored position will automatically be deleted when a new position is stored under the same button.

IMPORTANT Seat position memorization does not include lumbar adjustment and heating actuation.

Recalling stored positions

With the key in position **MAR**, any stored position can be recalled by briefly pressing the respective button “1”, “2” or “3”. The seat will move automatically and stop in the stored position.

Stored position are recalled only if the required position is different from the current one and is not possible when the car speed exceeds 10 km/h.

Seats can be moved only when the ignition key is at **MAR** and, for about 1 minute, also after removing the key or turning it to **STOP**: during this time, the external rear view mirrors will not move, but when the car is started again, they will be automatically realigned together with the seat position (see paragraph “Automatic realignment of external rear view mirrors”).

If stored seat position recalling is still in course after this time has elapsed, recalling will be concluded in any case.

If the engine is started during the recalling stage, seat moving will be stopped; once this stage is over the seat will return automatically to the stored position.

IMPORTANT Pressing any of memorisation or adjustment buttons during the recalling stage, causes the immediate stop of the seat (antipanic mode).

Storing the “parking” position of the external rear view mirror on passenger side

You can achieve better visibility during manoeuvres in reverse gear (for instance, when parking the car) by adjusting the external passenger rear view mirror to a different position from the one normally used. This position can be stored by the driver.

To store the position proceed as follows:

- with the car stopped and the ignition key at **MAR**, engage the reverse gear;
 - adjust the position of the external passenger rear view mirror by means of the respective controls so as to obtain the optimum position for the parking manoeuvre;
 - press down for at least 3 seconds any of buttons “1”, “2” or “3” (**fig. 46**) used to store/recall the seat position;
 - together with the “parking” position of the external passenger side rear view mirror, also the seat position, the driver rear view mirror position and the driving position of the external passenger side rear view mirror are stored.
- A sound signal warns the driver that the mirror position has been stored.

Recalling the “parking” position of the external rear view mirror on passenger side

To automatically recall the “parking” position of the external passenger rear view mirror, proceed as follows:

- with the car stopped and the ignition key at **MAR**, engage the reverse gear; the mirror will be automatically brought back to the previously stored position .

If no “parking” position has been stored, when engaging reverse the passenger mirror slightly lowers than normally to a preset position to facilitate the driver during parking.

The rear view mirror will automatically return to its initial position after about 10 seconds from reverse gear disengagement, or immediately after exceeding a speed of 10 km/h with forward gear.

IMPORTANT The “parking” position memorisation and recall can only be performed with ignition key at **MAR**.

Automatic realignment of external rear view mirrors

Every time the ignition key is turned to **MAR**, the external rear view mirrors automatically return to the latest position reached and/or recalled before removing the key.

This enables rear view mirror alignment if, when the car is parked, one of the rear view mirror has been manually and/or accidentally moved.



fig. 47

COMFORT SEATS (fig. 47)

Button **A** on front Comfort Seats enables to actuate the respective controls separately. When pressing the button of each of the two seats, the respective **CONNECT** menu is actuated; this menu makes it possible, through its various options, to define the heating levels and actuate ventilation, massage and the adaptive function for each of the two seats.

The Comfort controls can also be actuated by pressing the “Setup” key of the **CONNECT** and then selecting the “Seat Comfort” function.

To actuate these settings, refer to the **CONNECT** supplement provided with the car.

IMPORTANT Never turn the passenger massage function on when the seat is not occupied since the occupant sensor could activate (in the event of an accident) the relevant air bag.

HEAD RESTRAINTS (fig. 48)

Where provided, front head restraints can be adjusted electrically, so as to adapt to the driver's height.

To lift the head restraint, move control **B** (fig. 43) to 7; to lower the head restraint, move the aforesaid control to 8.

To remove the head restraints, move them upwards, to refit them, fit the rods back into the housings on the seat top.



fig. 48



Remember that the head restraints should be adjusted to support the back of your head and not your neck. Only if they are in this position will they be able to provide effective protection in the event of a rear-end shunt. Never drive your car without fitting the headrest: this is dangerous and, moreover, is prohibited by the law.

ARMREST (fig. 49)

The armrest **A** can be adjusted up or down to three different positions. To lift the armrest, pull it from handgrip **B**. To lower the armrest, keep knob **C** depressed.

The armrest incorporates a climate-controlled bottle/can holder (refer to the relevant paragraph in this chapter). To gain access to the bottle/can holder, lift armrest **A** by pulling it from handgrip **B**. To close the bottle/can holder, lower the armrest until it is locked; to lower it further, press knob **C**.

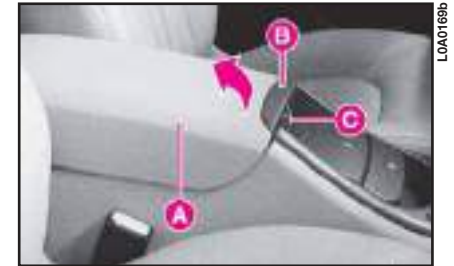

fig. 49

REAR SEATS

HEAD RESTRAINTS

The 3 rear head restraints (fig. 50-51) can be adjusted for height. To adjust, move the head restraint upwards or downwards according to the most suitable position.

Rear head restraints cannot be removed.



Remember that the head restraints should be adjusted to support the back of your head and not your neck. Only if they are in this position will they be able to provide effective protection in the event of a rear-end shunt.

Certain versions (where provided) have a button **A** (fig. 52) on the central console for lowering, with ignition key at **MAR**, the rear side head restraints.



fig. 50

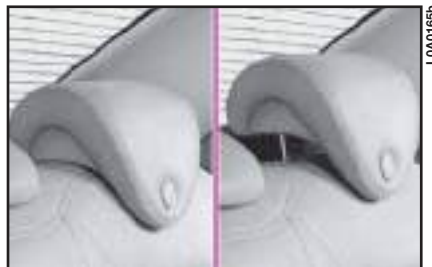

fig. 51



fig. 52

ARMREST

Lower the armrest to the position shown for use by pulling the lever **A** (fig. 53).

To close, lift the armrest into its housing.

An oddment compartment is concealed inside the armrest and according to versions it can contain the following:

- buttons for heating control, massage, lumbar adjustment and rear side seat adaptive function
- button for moving the front passenger seat

- button for opening/closing the electric sunshade
- current socket
- remote control for CONNECT HI-FI and TV functions.

IMPORTANT Read through the instruction given in paragraph “Interior equipment” in this chapter for current socket use.

To open the oddment compartment, lift the armrest cover using grip **A** (fig. 54). To close the oddment compartment lower the cover.

HEATING (fig. 55)

To switch side seat heating on, turn knob **A** (left-hand seat) or **B** (right-hand seat) to “1”, “2” or “3” that correspond to the different warming levels. To switch seat heating off, turn the knob to “0”.

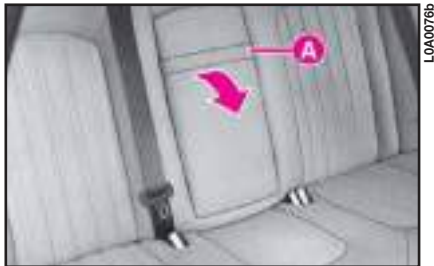

fig. 53



fig. 54



fig. 55

COMFORT SEATS

Side Comfort seats are fitted with independent control buttons for heating, lumbar adjustment, massage and adjusting function; these controls are located inside the armrest.

The armrest compartment houses also the button for moving the front passenger seat and the button controlling the electric sunshade.

Controls are operative in one of the following conditions:

- ignition switch to **MAR**
- for approx. 1 minute after removing the ignition key or turning it to **STOP**



fig. 56

- for approx. 3 minutes with key removed or turned to **STOP** and with door open.

Armrest compartment control button layout is as follows (**fig. 56**):

A – Buttons for lumbar adjustment, massage and right-hand seat adaptive function

B – Button for right-hand seat heating

C – Buttons for lumbar adjustment, massage and left-hand seat adaptive function

D – Button for left-hand seat heating

E – Button for moving front passenger's seat



fig. 57

F – Electric sunshade control button.

IMPORTANT To allow system automatic configuration, press the buttons for about 2 seconds to activate the required function.

Right-hand seat adjustment (fig. 57)

- 1 – Lumbar support increase
- 2 – Lumbar support decrease
- 3 – Massage activation
- 4 – Massage deactivation
- 5 – Adaptive function on
- 6 – Adaptive function off

This device makes it possible to vary back support and improve comfort. Press button **1** to increase the support and button **2** to decrease it.

The massage function reduces the stress specially during long journeys. Press button **3** to start the massage and button **4** to stop it.

The adaptive function makes it possible to adapt the seat back to the passenger thus improving comfort and back support. Press button **5** to activate this function and button **6** to deactivate it.

Right-hand seat heating – Button B (fig. 56)

To switch seat heating on, turn knob to “**1**”, “**2**” or “**3**” that correspond to the different warming levels. To switch seat heating off, turn the knob to “**0**”.

Left-hand seat adjustment (fig. 57)

- 7** – Lumbar support increase
- 8** – Lumbar support decrease
- 9** – Massage activation
- 10** – Massage deactivation
- 11** – Adaptive function on
- 12** – Adaptive function off

This device makes it possible to vary back support and improve comfort. Press button **7** to increase the support and button **8** to decrease it.

The massage function reduces the stress specially during long journeys. Press button **9** to start the massage and button **10** to stop it.

The adaptive function makes it possible to adapt the seat back to the passenger thus improving comfort and back support. Press button **11** to activate this function and button **12** to deactivate it.

Left-hand seat heating Button D (fig. 56)

To switch seat heating on, turn knob to “**1**”, “**2**” or “**3**” that correspond to the different warming levels. To switch seat heating off, turn the knob to “**0**”.

Moving the front passenger’s seat backwards or forwards – Button E (fig. 56)

Press the front part of the button to move the front passenger’s seat forward and increase the space available for the rear passenger. Press the rear part of the button to move the seat backwards.

Electric sunshade - Button F (fig. 56)

Press the front part of the button to open the sunshade and the rear part to close it (see paragraph “Electric sunshade” in this chapter).

STEERING WHEEL



Only make adjustments when the car is stationary.

ELECTRIC ADJUSTMENT

(fig. 58)

The steering wheel height and axial position can be adjusted electronically when the ignition key is at **MAR**.

To make adjustments, move lever **A** in four directions.



fig. 58

Steering wheel position is stored together with external rearview mirror position, when storing the driver's seat position.

MANUAL ADJUSTMENT (fig. 59)

The steering wheel height and axial position can be adjusted:

On certain versions the steering wheel height and axial position can be adjusted; proceed as follows:

- 1) Push lever **B** to **1**.
- 2) Move the steering wheel to the required position by pulling, pushing, lifting or lowering it.
- 3) Pull lever **B** to **2** to lock the steering wheel in place.



fig. 59



It is absolutely forbidden to carry out whatever after-market operation involving steering system or steering column modifications (e.g.: installation of anti-theft Device) that could badly affect performance and safety, cause the lapse of warranty and also result in non-compliance of the car with homologation requirements.

REARVIEW MIRRORS

INTERNAL REARVIEW MIRROR

Manually adjustable (fig. 60)

The mirror can be adjusted in four directions by means of lever A:

- 1) normal position
- 2) anti-dazzle position.

The mirror is also fitted with a safety device that releases the mirror in the event of an impact.



fig. 60

Automatically adjustable (fig. 61)

The mirror is automatically set to day and night position, irrespective of exterior lights.

The mirror sets always in day position when engage the reverse gear.



fig. 61

EXTERNAL REARVIEW MIRRORS

External rearview mirrors have flat surface and can be heated and adjusted automatically when the ignition key is at **MAR**.

Turn switch A (fig. 62) to position **1** (left-hand mirror) or to position **2** (right-hand mirror) to select the mirror to be adjusted.



fig. 62

Press switch **A** (fig. 62) to adjust the mirror in the four directions (fig. 63). After adjusting, turn switch **A** back to position **0** to prevent moving the mirrors accidentally.

The mirrors can be folded electrically to reduce side clearance. Turn switch **A** (fig. 62) to position **3** to fold the mirrors electrically. Turn the switch **A** to position **0** to return the mirrors to their normal position.

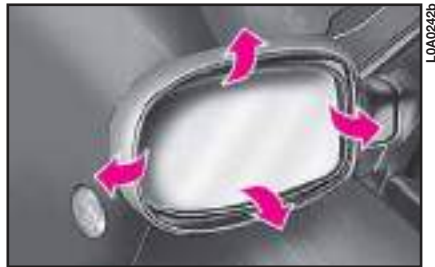

fig. 63



If the mirrors make it difficult to get through narrow gaps and in automatic car washes, fold them from position 1 to position 2 (fig. 64).

The mirrors are automatically demisted/defrosted when the heated rear window is operated.

IMPORTANT Rearview mirror surface is flat to make objects seem at their actual distance.

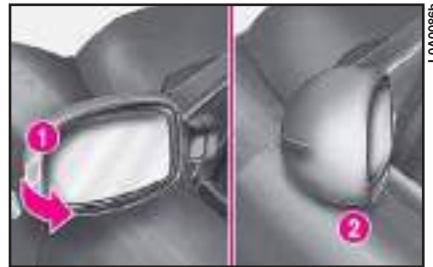

fig. 64

Automatic rearview mirror realignment

Rearview mirror position is stored, together with the steering wheel position, when storing the driver's seat position. Each time the ignition key is turned to **MAR**, rearview mirrors return automatically to the last position reached and/or recalled at the previous ignition key removal. This enables rearview mirror alignment if, when the car is parked, one of the rearview mirror has been manually and/or accidentally moved.

Storing the “parking” position of the right-hand rearview mirror

When storing the driver's seat positions, it is possible to store also the “parking” position of the right-hand rearview mirror. Stored position is recalled automatically when engaging the reverse gear. For further information about rearview mirror “parking” position storing and recalling, see paragraph “Front seats” in this chapter.

ELECTRIC WINDOWS

ANTI-TRAP SAFETY SYSTEM

Front and rear electric windows are provided with anti-trap safety device. When the system control unit detects an obstacle in the window closing travel, it makes the window travel stop and reverse immediately.

This system complies with regulation 2000/4/EC coming soon in force, which is destined to protect passengers leaning out of the windows. Therefore, in case of unlawful intrusions from the outside, the anti-trap safety device could not activate.

IMPORTANT In the event that the anti-trap function is activated 5 times in only 1 minute, the system will automatically enter the “recovery” mode (self-protection). This condition is pointed out by the fact that, in the closing phase, the window goes up in jerks.

It is therefore necessary in this case to carry out the system restore procedure by operating window opening control or turning the ignition key to **STOP** and then to **MAR**.

Regular operation is restored if no malfunction is present: otherwise contact a **Lancia Dealership**.

In the event that the system detects a malfunction, the failure message and symbol  will appear on the instrument panel display (see “Window anti-trap safety system” at paragraph “Warning lights”).



Improper use of the electrical window winders can be dangerous. Before and during their operation ensure that any passengers in the car are not at risk from the moving glass either by personal objects getting caught in the mechanism or by being injured by it directly. Always remove the ignition key when you get out of the car to prevent the electrical window winders being operated accidentally and constituting a danger to the people left in the car.

CONTROLS

Electric windows work with ignition key at **MAR**.

IMPORTANT With ignition key at **STOP** or after removing it, the electric windows can be still operated for about 2 minutes. They will deactivate immediately when opening one of the doors.

Driver's side

On the driver's door panel mask there are 5 buttons (**fig. 65**) for controlling every window.



fig. 65

Front windows

Press buttons **A** or **B** to open/close the required window (driver or passenger side). Pressing briefly the button the window “jerks”, whereas a prolonged pressing makes the window opening or closing in “automatic and continuous” mode. When pressing again the button the window stops in the required position.

A – Front left window opening/ closing, “continuous automatic” operation during window opening/ closing

B – Front right window opening/ closing, “continuous automatic” operation during window opening/ closing.

Rear windows

Press buttons **C** or **D** to open/close the required window (left or right side). Pressing briefly the button the window “jerks”, whereas a prolonged pressing makes the window opening in “automatic and continuous” mode. When pressing again the button the window stops in the required position.

C – Rear left window opening/closing, “continuous automatic” operation just during window opening

D – Rear right window opening/closing, “continuous automatic” operation just during window opening

E – Rear window controls enabling/disabling button; controls are disabled when the button led is on.

Passenger's side

On the passenger's door panel mask there is button **A** (**fig. 66**), for opening/closing the passenger's window.



fig. 66

Pressing briefly the button the window “jerks”, whereas a prolonged pressing makes the window opening or closing in “automatic and continuous” mode. When pressing again the button the window stops in the required position.

Rear controls

On the rear doors panel mask there is button **A** (fig. 67), for opening/closing the corresponding window.

Pressing briefly the button the window “jerks”, whereas a prolonged pressing makes the window opening or closing in “automatic and continuous” mode. When pressing again the button the window stops in the required position.



fig. 67

MANUAL AND AUTOMATIC OPERATION

Front and rear window winders can be operated both automatically (opening and closing) and manually.

Long or short pulse determines the type of operation.

Pull up or press the control button to activate automatic closing or opening; the window will stop when it reaches the end of its travel (or when the button is pressed again).

A short pulse results in a short window movement that stops when releasing the button.

CENTRALISED WINDOW AND SUNROOF OPENING/CLOSING SYSTEM

Centralised window and sunroof opening/closing is activated in the following conditions:

- ignition key removed;
- doors perfectly closed.

To activate centralised window and sunroof closing, keep the remote control button **B** (fig. 68) pressed for over 2 seconds after closing the doors: window and sunroof will move until complete closing or until releasing the button.

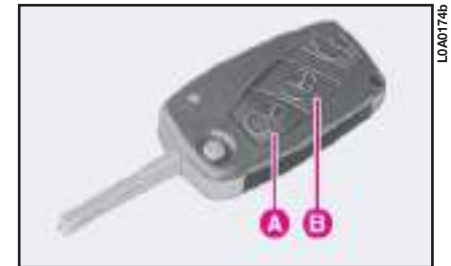

fig. 68

To activate centralised window and sunroof opening, keep button **A** (fig. 68) pressed for over 2 seconds after opening the doors: window and sunroof will move until complete opening or until releasing the button.

This function can be used to aerate the passenger's compartment before getting into the car parked in the sun.

SEAT BELTS

HOW TO USE THE SEAT BELTS

The belt should be worn keeping the chest straight and rested against the seat back.

Instrument panel warning light  will come on if the ignition key is turned to **MAR** and the driver's seat belt is not fastened.

To fasten the seat belt, take the fastening tongue **A** (fig. 69) and push it into buckle **B**, until you hear it click.

Pull the seat belt gently. If it jams, let it rewind a little and pull it out again without jerking.

To release the seat belts, press button **C**. Guide the seat belt with your hand while it is rewinding to prevent it from twisting.



Never press button C (fig. 69) while travelling.

Through the reel, the belt automatically adapts to the body of the passenger wearing it, allowing freedom of movement.



fig. 69

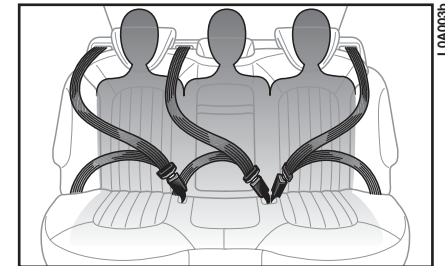

fig. 70

When the car is parked on a steep slope the reel mechanism may block; this is normal. The reel mechanism prevents the webbing coming out when it is jerked or if the car brakes sharply, in a collision or when cornering at high speed.

The rear seat is fitted with inertial seat belts with three anchor points and reel for the side and centre seats.

Rear seat belts shall be worn as shown in **fig. 70**.

To prevent incorrect fastening, the tongues of the side seats and the buckle of the centre lap belt are incompatible.



fig. 71

When the rear seats are not occupied, use the spaces provided in the cushion to stow the belt buckles (**fig. 71**).



Remember that in the event of a violent collision, back seat passengers not wearing seat belts also represent a serious danger for the front seat passengers.

ADJUSTING THE HEIGHT OF THE FRONT SEAT BELTS



Only adjust seat belt height when the car is stationary.

Always adjust the height of the seat belt to fit the person wearing it. This precaution could greatly reduce the risk of injury in case of collision.

Correct adjustment is obtained when the belt passes half way between the end of the shoulder and the neck.

To adjust, lower or raise the grip **A** (**fig. 72**). To lower the device keep button **B** pressed.



After adjustment, always check that the device is anchored in one of the positions provided. To do this, with the grip released, exert a further pressure to allow the anchor device to catch if release did not take place at one of the preset positions.



fig. 72

PRETENSIONERS

Your car is fitted with pretensioners on the front and rear side seats to improve protection.

These devices “feel”, through a sensor, that a violent crash is in progress and rewind the seat belts a few centimetres. In this way they ensure that the seat belt adheres perfectly to the wearer before the restraining action begins.

The seat belt locks to indicate that the device has intervened; the seat belt cannot be drawn back up even when guiding it manually.

IMPORTANT To obtain the highest degree of protection from the action of the pretensioning device, wear the seat belt keeping it firmly close to the chest and pelvis.

Front seat pretensioners activate only if front seat belts are properly fitted into buckles.

A small amount of smoke may be produced. This smoke is in no way toxic and presents no fire hazard.

The pretensioner does not require any maintenance or greasing. Anything that modifies its original conditions invalidates its efficiency. If due to unusual natural events (floods, sea storm, etc.) the device has been affected by water and mud, it must necessarily be replaced.



The pretensioner can only be used once. After a collision that has triggered it, have it replaced at a Lancia Dealership Pretensioner validity is written on the plate located on the front left door post near door hinges. The pretensioners should be replaced at a Lancia Dealership as this date approaches.



Operations which lead to knocks, vibrations or localised heating (over 100°C for a maximum of 6 hours) in the area around the pretensioners may cause damage or trigger them. These devices are not affected by vibrations caused by irregularities of the road surface or low obstacles such as kerbs, etc. Contact a Lancia Dealership for any assistance.

LOAD LIMITING DEVICES

In order to increase passive safety, the front and rear seat belt reels have a built-in load limiting device which collapse in a controlled fashion so to dose the force on the passenger's shoulder and chest during the retaining operation.

GENERAL INSTRUCTIONS FOR THE USE OF THE SEAT BELTS

The driver must comply with (and have the vehicle occupants follow) all the local legal regulations concerning the use of seat belts.

Always fasten the seat belts before starting.



For maximum safety, keep the back of your seat upright, lean back into it and make sure the seat belt fits closely across your chest and hips.

Make sure that the seat belts of the front and rear passengers are fastened at all times! You increase the risk of serious injury or death in a collision if you travel with the belts unfastened.



The belt should not be twisted, make sure that it is taut and adheres to the passenger's body. The upper part should pass over the shoulder and cross the chest diagonally. The lower part should adhere to the pelvis and to the abdomen of the passenger (fig. 73). Do not use any objects (pegs, stoppers, etc.) to keep the belts away from the body.

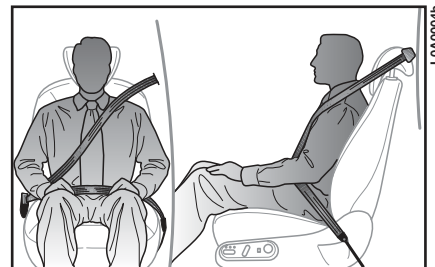

fig. 73



Under no circumstances should the components of the seat belts and pretensioner be tampered with or removed. Any operation should be carried out by qualified and authorised personnel. Always contact a Lancia Dealership.

If the belt has been subjected to heavy stress, for example after an accident, it should be changed completely together with the anchors, anchor fastening screws and the pretensioners. In fact, even if the belt has no visible defects, it could have lost its resilience.

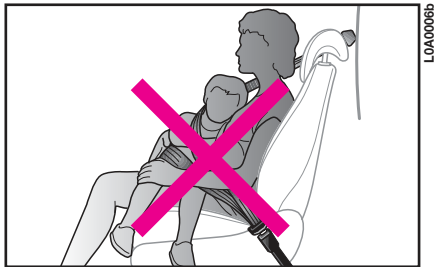

fig. 74



Never travel with a child sitting on the passenger's lap with a single belt to protect them both (fig. 74). Do not fasten other objects to the body.

Seat belts are also to be worn by expectant mothers: the risk of injury in the case of accident is greatly reduced for them and the unborn child if they are wearing a seat belt.

Of course they must position the lower part of the belt very low down so that it passes under the abdomen (fig. 75).

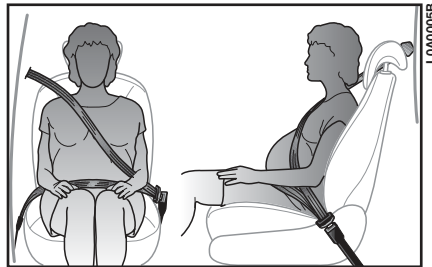

fig. 75

HOW TO KEEP THE SEAT BELTS IN PROPER WORKING ORDER AT ALL TIMES

1) Always use the belt with the tape taut and never twisted; make sure that it is free to run without impediments.

2) After a serious accident, replace the belt being worn at that time, even if it does not appear damaged. Always replace the seat belts if pretensioners have been activated.

3) To clean the belts, wash by hand with neutral soap, rinse and leave to dry in the shade. Never use strong detergents, bleach or dyes or other chemical substance that might weaken the fibres.

4) Prevent the reels from getting wet: their correct operation is only guaranteed if water does not get inside.

5) Replace the seat belt when showing significant wear or cut signs.

CARRYING CHILDREN SAFELY



With passenger's air bag active, never place child's seats with the cradle facing backwards since the air bag activation could cause to the child serious injuries, even mortal, regardless of the seriousness of the crash that triggered it. You are advised to carry children always with proper restraint systems on the rear seats, as this is the most protected position in the case of a crash.



SERIOUS DANGER
Should it be absolutely necessary to carry a baby on the front passenger seat with a child's seat with the cradle facing backwards, deactivate the passenger's air bags using the key switch and then check warning light F on the cluster to make sure that deactivation has actually taken place (see paragraph "Manual deactivation of passenger's air bag").

For optimal protection in the event of a crash, all passengers must be seated and wearing adequate restraint systems.

This is especially relevant for children.

According to 2003/20/EC Directive, this prescription is compulsory for all European Community countries.

A child's head is larger and heavier than an adult's head with respect to their body weight. Moreover, a child's muscular and bone structure is not fully developed. For these reasons, children require specific restraint systems, different from those required by adult passengers.

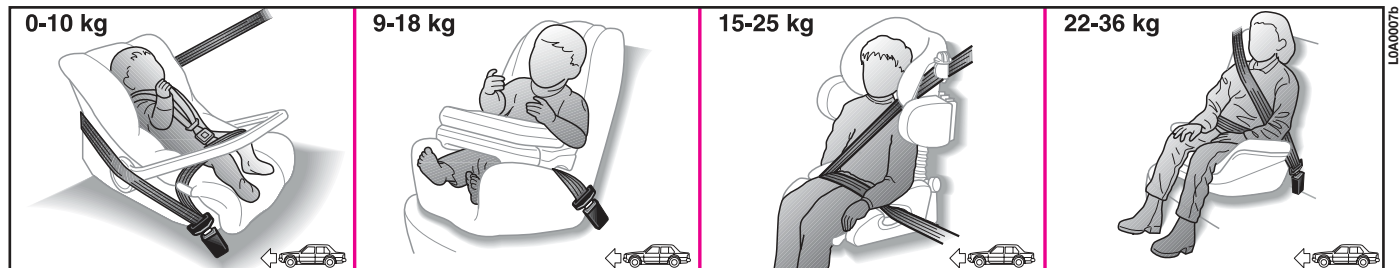

fig. 76

LOA00076

The results of research on the best child restraint systems are contained in the European Standard ECE-R44. This Standard enforces the use of restraint systems classified in five groups:

- Group 0 - weight 0-10 kg
- Group 0+ - weight 0-13 kg
- Group 1 weight 9-18 kg
- Group 2 weight 15-25 kg
- Group 3 weight 22-36 kg

The groups partially overlap. This is because there are systems which cover more than one weight group (fig. 76).

All restraint systems must show homologation data and control markings on a tag which is solidly fastened to the system and cannot be removed.

Children weighing more than 1.5 m are, with reference to restraint systems, considered adults and can wear normal seat belts.

We recommend using Lineaccessori Lancia child restraint systems for each weight group. These systems were specifically designed and tested for Lancia cars.

GROUP 0 and 0+

Babies up to 13 kg are to be seated in a cot type seat supporting the child's head facing backwards. This ensures there is no stress on the child's neck in sudden decelerations.

The cot is secured with the seat belts. Furthermore, the child must be strapped to the cot (fig. 77).



The figure is only an example. Follow the instructions for fastening the specific child restraint system you are using.

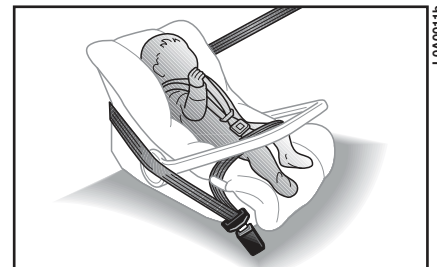

fig. 77

GROUP 1

Children from 9 to 18 kg are to be seated facing forward in child seats with front cushion. The car seat belt secures both seat and child (fig. 78).



The figure is only an example. Follow the instructions for fastening the specific child restraint system you are using.

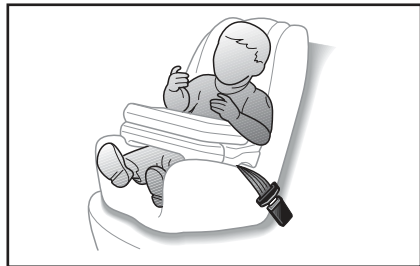

fig. 78



There are child restraint for groups 0 and 1 which are fastened with the car seat belts by means of an attachment on the seat back. The child is then secured to the seat with specific straps. Due to their weight, child seats can be dangerous if they are fitted incorrectly (e.g. with a cushion placed therebetween). Always follow carefully the specific installation instructions for the child restraint system you are using.

GROUP 2

Children from 15 to 25 kg can be secured directly with the car seat belts. The seat has the purpose of positioning the child correctly with respect to the seat belt so that the diagonal section crosses the child's chest (never the child's throat) and the horizontal section fits snugly on the child's hips (and not the child's abdomen) (fig. 79).



The figure is only an example. Follow the instructions for fastening the specific child restraint system you are using.

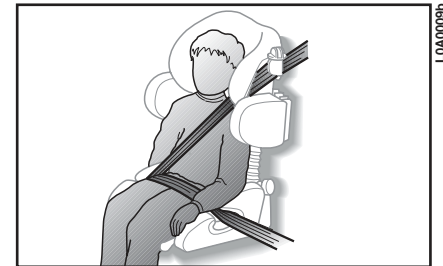

fig. 79

GROUP 3

Children from 22 to 36 kg the size of the child's chest no longer requires a support to space the child's back from the seat back.

Fig. 80 shows proper child seat positioning on the rear seat.

Children taller than 1.5 m can wear seat belts like adults.



fig. 80

PASSENGER SEAT COMPLIANCE WITH REGULATIONS ON CHILD'S SEAT USE

THESIS complies with the new EC Directive 2000/3/CE regulating child's seat assembling on the different car seats according to the following tables:

| Group | Range of weight | SEAT | | |
|-------------|-----------------|-----------------|----------------------|------------------------|
| | | Front passenger | Side rear passengers | Central rear passenger |
| Group 0, 0+ | 0 -13 kg | U | L-U | U |
| Group 1 | 9 -18 kg | U | L-U | U |
| Group 2 | 15 -25 kg | U | L-U | U |
| Group 3 | 22 -36 kg | U | L-U | U |

Key:

U = Suitable for child restraint systems of the "Universal" category, according to European Standard ECE-R44 for the specified "Groups"

B = Built-in restraint system approved for this range of weight (integral child's seat opt.)

L = Suitable for certain child's restraint systems available at Lineaccessori Lancia for the specified group

Below is a summary of the rules of safety to be followed for carrying children:

1) Child restraint system should be fitted on the rear seat as this is the most protected area in the car in the event of a crash.



Children must never be seated in the front passenger seat in cars with passenger's front airbag.

2) In case of passenger airbag deactivation check that instrument panel warning light  is on to make sure that deactivation has actually taken place .

3) Follow the instructions for fastening the specific child restraint system you are using which must be provided by the manufacturer. Keep the child restraint system installation instructions with the car papers and with this handbook. Never use a child restraint system without the installation instructions.

4) Always check the seat belt is well fastened by pulling the webbing.

5) Only one child is to be strapped to each retaining system.

6) Always check the seat belts do not fit around the child's throat.

7) While travelling do not let the child sit incorrectly or release the belts.

8) Passengers should never carry children on their laps. No-one, however strong they are, can hold a child in the event of a crash.

9) In case of an accident, replace the seat with a new one.

PRESETTING FOR MOUNTING THE "ISOFIX TYPE" CHILD RESTRAINT SYSTEM

THESIS is preset for mounting the Isofix type child restraint system, a new European standardised system for transporting children. Isofix type child restraint system is an additional option that does not prevent from using traditional child restraint systems. Isofix type child's seat covers three weight groups: **0, 0+** and **1**.

Due to its different anchoring system, the Isofix type child's seat shall be anchored using the proper metal brackets set between rear seat back and cushion, shown in **figures 81** and **82**.

It is possible to mount both the traditional child restraint system and the Isofix type one. Max. two Isofix type child's seats can be mounted on the rear seat using the proper couplings.

On the front passenger seat it is possible to mount only traditional child's seats.

Only use Isofix type child restraint systems specifically designed, tested and approved for this car.



Mount the child restraint system only with the car stationary. The Isofix child restraint system is properly anchored to the mounting brackets when clicks are heard. In any case, keep to the installation instructions that must be provided by the child restraint system's Manufacturer.

Mounting the ISOFIX TYPE child restraint system

Groups 0 and 0+

For children included in this weight group (up to 13 kg) the restraint system faces back and the child is held by the restraint system belts D (fig. 83).



fig. 81



fig. 82

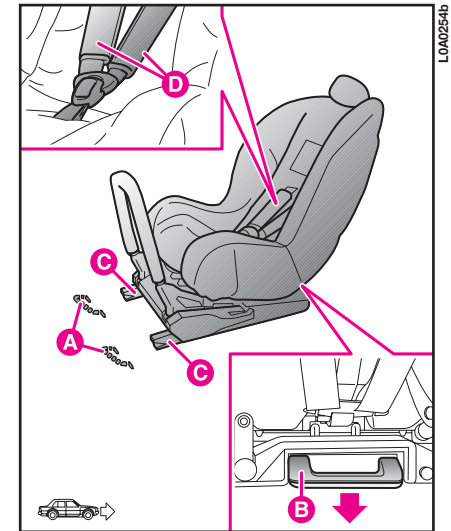

fig. 83

For proper mounting, proceed as follows:

- remove the upper tether on the back of the child's restraint system;
- check whether the release lever **B** (fig. 83) is at rest position (inward);

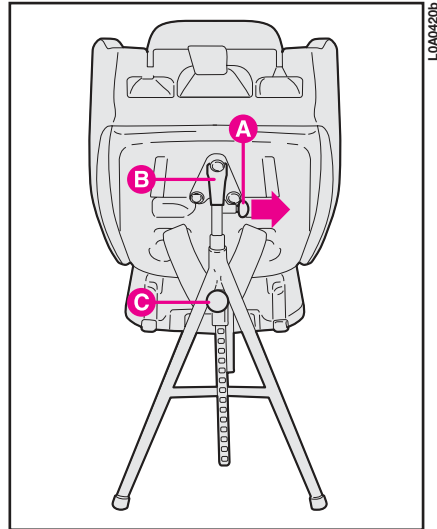

fig. 84

– identify the brackets **A** (fig. 83) and mount the child restraint system with the retainers **C** (fig. 83) aligned to the brackets;

– push the child restraint system until hearing the locking clicks;

– check for proper locking by moving the child's seat with force: the built-in safety mechanism actually inhibit improper coupling with just one coupling locked;

– fit the supporting foot into support **B** (fig. 84), secured on the child's seat back; to do this, pull knob **A** (fig. 84) outwards, fit the foot into the support, release knob **A** and push the foot upwards until the locking pin clicks;

– fully loosen knob **C** (fig. 84) and extend both support legs until they rest on the car floor; tighten knob **C** in one of the preset holes.

Group 1

When the child grows up and reaches the next weight group (group 1, 9 to 18 kg), the child restraint system should be reinstalled facing forward; keep to the instructions provided by the child restraint system manufacturer.

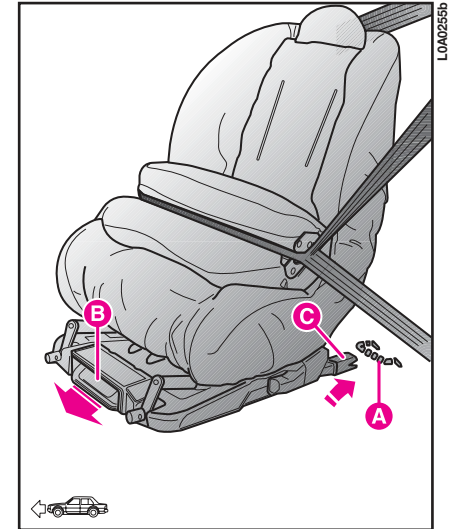

fig. 85

For proper mounting, proceed as follows:

- remove the upper tether on the back of the child's restraint system;
- remove the black plate on the child's seat back and loosen the three knob screws completely;
- check whether the release lever **B** (fig. 85) is at rest position (inward);
- identify the brackets **A** (fig. 85) and mount the child restraint system with the retainers **C** (fig. 85) aligned to the brackets;
- push the child restraint system until hearing the locking clicks;
- check for proper locking by moving the child's seat with force: the built-in safety mechanism actually inhibit improper coupling with just one coupling locked.

With this configuration, the child is secured also by the car seat belts (fig. 85).

To apply car seat belts to child's seat, refer to the child's seat handbook.

FRONT AND SIDE AIRBAGS

The car is equipped with front (Multistage) airbags for the driver (fig. 86) and passenger **B** (fig. 87), front side bags **C** (fig. 88), window bags **D** (fig. 89) and (where provided) rear side bags **E** (fig. 90).

“SMART BAG” SYSTEM (FRONT MULTISTAGE AIRBAGS)

Description and operation

The front air bag (driver and passenger) is a safety device which comes into action in the event of a front/angled impact.



fig. 86

It consists of an instantly inflatable bag housed in a special compartment located:

- in the centre of the steering wheel on the driver's side **A** (fig. 86);
- in the dashboard on the passenger's side (larger bag) **B** (fig. 87).



fig. 87



fig. 88

The front airbag (driver and passenger) has been designed to protect the occupants in the event of head-on/angled collision of medium-high severity, by placing a soft bag between the passenger and the steering wheel or the dashboard.

In case of head-on collision, an electronic control unit processes the signals from deceleration sensor and, when required, triggers the inflation of the cushion according to the severity of the collision.



fig. 89

The cushion immediately inflates, placing itself as a soft protective barrier between the body of the front passengers and the structure that could cause injuries. Immediately after, the cushion deflates.

The front air bag (driver and passenger) is not a replacement for the use of seat belts but rather a complement. We recommend that seat belts are worn at all times as prescribed by legislation in Europe and most other countries world-wide. A passenger not wearing the seat belt may crash into the bag before it is fully inflated. In this case the protection is considerably decreased.



fig. 90

Front air bags are designed to protect car's passengers in front/angled crashes and therefore non-activation in other types of collisions (side collisions, rear-end shunts, roll-overs, etc...) is not a system malfunction.

For impacts against very deformable or mobile objects (traffic sign poles, heaps of gravel or snow, etc...), rear impacts (e.g. car crashing into the back), side impacts, wedging under other vehicles or barriers (e.g. under a truck or guard rail), the airbag does not offer additional protection with respect to the seat belts and may even be undesirable.

The fact that the airbag is not triggered in these situations, this does not signify a malfunction.

PASSENGER'S FRONT AIRBAG

The passenger's airbag was designed and calibrated to protect a person wearing seat belts.

When fully inflated the bag will fill most of the space between the dashboard and the passenger.



SEVERE DANGER: The car is equipped with front passenger's airbag, do not place the child restraint seat on the front seat. The inflation of the airbag could cause even fatal injury. If required, always deactivate the passenger's front airbag when a child seat is placed on the front seat. The passenger's seat shall be set as backwards as possible to prevent accidental contacts between the child restraint system and the dashboard. Although it may not be prescribed by law, we recommend reactivating the airbag as soon as it is no longer necessary to carry children to provide better protection to adult passengers.

MANUALLY DEACTIVATING THE PASSENGER'S FRONT AIRBAG

The passenger's front airbag can be deactivated if it is absolutely necessary to carry a child in the front passenger seat.

Deactivation/reactivation takes place with ignition key at **STOP** and operating it in the special key switch **A** (fig. 91) on the dashboard on the passenger side.

You can reach the switch only if the door is opened.



fig. 91

LOA0072b



Only turn the switch when the engine is not running and the ignition key is removed.

The key switch has two possible positions:

1) Passenger's front airbag active (position **ON**  off. Do not carry children on the front seat.

2) Passenger's front airbag deactivated (position **OFF**  on. A child may be carried on the front seat, protected with a specific restraint system.

The  warning light on the instrument panel will stay on until the passenger front airbag is reactivated.

The side airbag will work although the front airbag is deactivated.

The key can be inserted and removed from the switch with the door open in any of the two positions.

IMPORTANT To receive the best system protection in the event of an accident, you have to seat in proper position (**fig. 92**).



fig. 92

SIDE AIRBAGS (SIDE BAG - WINDOW BAG)

Purpose of the side airbags is to increase passenger protection in the event of a side impact of medium to high severity.

Side airbags consist of two types of instantly inflatable bags:

- the side bags housed in the front seat bags **C (fig. 88)** and (where provided) in the side stuffing of the rear seats **E (fig. 90)**. This solution ensures that the bag is always in an optimal position with respect to the passenger, regardless of the seat position;

- the window bags, which are “curtain” cushions located behind the side coverings of the roof and covered by proper finishings such to allow the cushion unfolding downwards; this solution, studied for the head protection, allows offering the best protection to the front and rear passengers in the event of side crash, thanks to the wide cushion inflation surface.

In the event of a side collision the electronic control unit processes the signals coming from a deceleration sensor and, if required, fire the bags.

The bags inflate instantly and act as a soft protective barrier between the body of the passengers and the car door. Bags deflate immediately afterwards.

In the event of side collisions at low speed, the restraining action of the seat belts is sufficient and the airbag is not inflated. Also in this case it is of vital importance to wear the seat belts since in case of side crash they guarantee proper positioning of the passenger and prevent the occupants to be pitched out of the car in case of violent crashes.

The front and rear side bag is not a replacement for the use of seat belts but rather a complement. We recommend that seat belts are worn at all times as prescribed by legislation in Europe and most other countries world-wide.

Operation of the front bags is not disabled by the passenger's front airbag and rear side bag deactivation switch.

IMPORTANT In the event of side crash, you can obtain the best protection by the system keeping a correct position on the seat, allowing thus a correct window bag unfolding.



Never rest head, arms and elbows on the door, on the windows and in the window bag area to prevent possible injuries during the inflation phase.

IMPORTANT The front airbags and/or front and rear side bags can be triggered if the car is involved in hard impacts or collisions in the area of the underbody, such as for example violent impacts against steps, kerbs or projecting objects fixed to the ground or if the car falls into large pot-holes or dips in the road surface.

IMPORTANT When the airbag is fired it emits a small amount of powder and smoke. This is not harmful and does not indicate the beginning of a fire. Furthermore the surface of the inflated bag and the passenger compartment may be covered with powder residues. This powder may irritate skin and eyes. In the event of exposure, wash with mild soap and water.



Never lean head, arms and elbows out of the window.

IMPORTANT If the  warning light does not turn on when turning the ignition key to **MAR** or if it stays on when travelling, (together with message on display) this could indicate a failure in safety retaining systems; under this condition air bags or pretensioners could not trigger in the event of collision or, in a restricted number of cases, they could trigger accidentally. Stop the car and contact **Lancia Dealership** to have the system checked immediately.

The air bag system has a validity of 14 years as concerns the pyrotechnic charge and 10 years as concerns the coil contact (see the plate on the front left door). As these dates approach, contact Lancia Dealership to have them replaced.

IMPORTANT After an accident which triggered the airbags, go to a **Lancia Dealership** to have the entire safety system, the electronic control unit, the seat belts and the pretensioners replaced and to have the electrical system checked.

Any diagnostic, repair or replacement operations concerning the airbag system must exclusively be carried out at a **Lancia Dealership**.

If you are having the car scrapped, have the airbag system deactivated at a **Lancia Dealership** first.

If the car changes hands, the new owner must be made aware of the indications given above and be given this Owner Handbook.

IMPORTANT Pretensioners, front airbags and side bags are activated by the electronic control unit according to the type of impact. Consequently, missed activation of one or more system components does not indicate a fault in the system.

MANUALLY DEACTIVATING THE REAR SIDE BAGS (where provided)

Side bags, protecting the chest of the rear passengers, can be deactivated as follows.

Use the ignition key to operate the key switch **A** (fig. 93) located on the right side of the boot. This switch can be reached only with tailgate open.



Operate the switch only when the engine is stopped and the ignition key is removed.

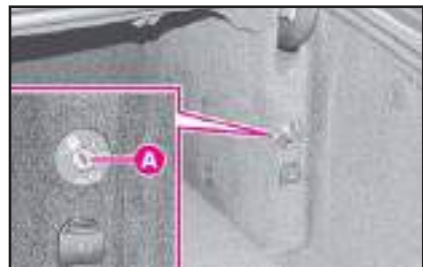





fig. 93

The key switch has two positions:

1) Passenger's front airbag active (position **ON**  off. Do not carry children on the front seat.

2) Passenger's front airbag deactivated (position **OFF**  on. A child may be carried on the front seat, protected with a specific restraint system.

IMPORTANT The car is delivered with rear side bags deactivated (position **OFF** ) and instrument panel warning light  on.



SEVERE DANGER: In presence of small size occupants (children, etc.) on the rear seats, it is necessary to deactivate the rear side bags through the apposite deactivation switch located in the boot.

GENERAL NOTES



If the  warning light does not turn on when turning the ignition key to MAR or if it stays on when travelling (together with message on display), this could indicate a failure in safety retaining systems; under this condition air bags or pretensioners could not trigger in the event of collision or, in a restricted number of cases, they could trigger accidentally. Stop the car and contact Lancia Dealership to have the system checked immediately.



Do not apply stickers or other objects to the steering wheel, to the passenger's airbag cover or to the roof side cover. Do not place objects (like mobile phones) on the dashboard on passenger side since they could interfere with proper passenger's airbag deployment and cause severe injuries.



Do not cover the back rest of front and rear seats with trims or covers there are not set for the use of side bags.



Do not travel with objects on your lap or in front of you nor with a pipe, pencil or similar between your lips. You could seriously hurt yourself if the airbag inflates in a collision.



Always drive with both hands on the rim of the steering wheel so that the airbag is free to inflate during a head-on collision and protect you from serious injury. Do not drive with your body bending towards the steering wheel, but sit in an upright position with your back resting against the seat.





If an attempt has been made to steal the car, or if it has actually been stolen or has been vandalised in anyway or subjected to flooding, have the airbag system checked over at a Lancia Dealership.



It is important to remember that the airbag can be fired even when the car is stationary if it is hit by another vehicle travelling at suitable speed. As a consequence, never sit children in the front seat, even if the car is not moving. On the contrary, the airbags will not be fired if the car is crashed into when the key is not inserted or turned. Consequently, in this case, the fact that the system is not fired does not indicate a fault.



When the ignition key is turned to MAR (passenger front airbag and rear side bag deactivation switch at ON), warning lights  and  will come on flashing for a few seconds to remind the driver that passenger front airbag and rear side bags will be fired in the event of a crash. Warning lights should go out immediately afterwards.



Do not wash the seat back rest with pressurised water or steam (by hand or at automatic seat washing stations).



The airbag is set to be fired in the event of collisions which are greater than the pretensioner settings. Consequently, for collisions in the bracket between the two thresholds, it is normal for only the pretensioners to be fired.



Do not hook rigid objects to the coat hooks and to the support handles.



The airbag does not replace seat belts but rather increases their effectiveness. Furthermore, the airbag is not fired in the event of low speed front collisions, rear-end shunts and roll-overs. In these cases, the passengers are only protected by the seat belts which for this reason must always be fastened.

LIGHT SWITCH AND STEERING COLUMN STALKS

The devices and services controlled by light switch and steering column stalks can only be activated with the ignition key at **MAR**, excluding the parking lights that are switched on only with key at **STOP** or removed.

Outside lights can be switched on manually or automatically according to daylight intensity.

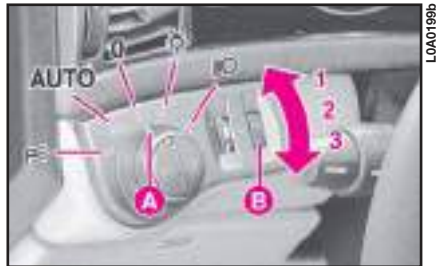

fig. 94

LIGHT SWITCH (fig. 94)

It has 5 positions:

0 - outside lights off

☼ - side/taillights

☾ - dipped beam headlights

☾ - parking lights

AUTO - automatic outside light switching on/off according to set sensitivity level.

Outside lights off

Outside lights are off when ring A is turned to 0.

Side/taillights and number plate lights

To switch these lights on, turn ring A to ☼.

When these lights are on, instrument panel warning light ☼ lights up.

When the outside lights are turned on, the instrument panel and the various controls and displays located on the dashboard and central console light up.

Dipped beam headlights

These lights come on when you turn ring A to ☾.

Parking lights

With ignition key at **STOP** or removed, turn ring A to ☾ to switch the parking lights on (side/taillights), the relevant instrument panel warning light will come on.

When parking lights are on, move the left stalk downwards to switch on only the left side lights and move it upwards to switch on only the right side lights. In this case the number plate lights and the instrument panel warning light will not come on.

When parking lights are on, a buzzer will sound when opening the driver's door. Buzzer sound will stop when closing the door or switching the lights off.

Automatic switching on/off

When ring **A** is turned to **AUTO** and the ignition key is at **MAR**, side/taillights, number plate lights and dipped beam headlights will turn on/off automatically according to daylight intensity.

The twilight sensor sensitivity of the automatic light on/off system can be set, also when travelling, through the 3-position ring **B**:

- 1 - low sensitivity
- 2 - medium sensitivity
- 3 - high sensitivity.

IMPORTANT Main beam headlights can only be switched on manually by moving the left stalk forwards.

With automatic switching on activated and switching off control given by the sensor, main beam headlights go off followed after about 10 seconds, by the side/tail-lights.



If main beam headlights are on (left stalk forwards), they will turn on automatically each time the twilight sensor makes the outside lights switch on automatically. It is therefore recommended to turn off the main beam headlights (if on), moving backwards the left stalk, each time the sensor switches off the outside lights.



Twilight sensor is not able to detect the fog presence, it is therefore necessary to switch on the lights manually, including the front and rear fog lights.

IMPORTANT When switching on the headlights automatically, it is possible to switch on the front and rear fog lights. When headlights are automatically switched off, the front and rear fog lights (if previously activated) will be switched off as well. At the following automatic switching-on, only the front fog lights will switch on, whereas the rear fog lights, if required, will have to be switched on manually.



The driver is responsible for the use of the lights according to the light intensity and traffic regulations of the country where the car is being driven. Automatic switching on/off must be considered just as an help for the driver since he/she must always switch on/off the lights manually as necessary.

Twilight sensor

It is composed by an infrared led sensor installed on the windscreen in order to detect the changes of the external light intensity of the car, as a function of the light sensitivity set; greater is the sensitivity, smaller is the amount of external light necessary to control the switching-on of the exterior headlights.

It consists of two sensors: a global sensor for evaluating environment light intensity and a directional one for evaluating light intensity in running direction in order to recognize tunnels, dark road sections, etc.

When ring **A** is turned to **AUTO** (automatic light switching on), and the twilight sensor is malfunctioning, side/taillights and dipped beam headlights are switched on regardless of the light intensity and the display on the instrument panel shows the message “**TWILIGHT SENSOR FAULT – GO TO DEALER**”. Failure indication will stay on as long as ring **A** is turned to **AUTO**. In this case it is recommended to deactivate the automatic function and switch on the lights manually; contact a **Lancia Dealership** as soon as possible.

Delayed light switching off (“Follow me home” device)

This device allows the illumination of the space in front of the car for a length of time of 30 seconds (or a multiple of 30) and is activated with the ignition key at **STOP** or removed.

This device is activated by pulling towards the steering wheel and then releasing the left-hand stalk within 2 minutes from when the engine is turned off. At each operation of the stalk, the staying on of the lights is extended by 30 seconds, up to a maximum of 210 seconds that correspond to 7 stalk operations, then the lights are switched off automatically.

Total set time (in seconds) is shown on the instrument panel display for about 20 seconds.

After activating the device, the set time can be extended also within 2 minutes from when the engine is turned off by pulling the stalk.

Keeping the stalk pulled for over 2 seconds will deactivate this function with immediate light turning off as a consequence.

LEFT-HAND STALK

The left-hand stalk controls the external lights and the direction indicators.

Main beam headlights (fig. 95)

These lights come on pushing the left-hand stalk forwards (position **A**), with dipped beam headlights switched on both manually (ring to ) and automatically (ring to **AUTO**).

When these lights are on, the instrument panel warning light  is on.

To switch the main beam headlights off, pull the stalk back towards the steering wheel.



fig. 95



If main beam headlights are on (left stalk forwards), they will turn on automatically each time the two-light sensor makes the outside lights switch on automatically. It is therefore recommended to turn off the main beam headlights (if on), moving backwards the left stalk, each time the sensor switches off the outside lights.

To flash the lights (fig. 96)

Pull the stalk towards the steering wheel (position **B**). Instrument panel warning light  will come on.



fig. 96



IMPORTANT This operation will flash the main beam headlights. Follow the Highway Code to prevent being fined.

Direction indicators (fig. 96)

Move the stalk as follows:

up (position **A**) - to switch on the right-hand indicators

down (position **B**) - to switch on the left-hand indicators.

When direction indicators are on, instrument panel warning light  or  will flash.

The direction indicators return automatically to neutral position when the car straightens up.

IMPORTANT If you want the indicator to flash briefly to show that you are about to change lane, move the stalk up or down without clicking into position. When you let it go it will return to its original position.

RIGHT-HAND STALK

The right-hand stalk controls all the washer/wiper controls.

Windscreen wiper (fig. 97)

This device can only work when the ignition key is at **MAR**. The stalk can be moved to 5 different positions:

0 - Windscreen wiper off.

1 - automatic operation. Turn ring **A** to this position to set the rain sensor sensitivity.

2 - Continuous slow.

3 - Continuous fast.



fig. 97

4 - Fast temporary (unstable position): when releasing the stalk it returns to **0** stopping the windscreen wiper.

Windscreen washer (fig. 98)

Pulling the stalk towards the steering wheel (unstable position) operates the windscreen washer.

Keeping the stalk pulled, with just one movement it is possible to operate the washer jet and the wiper at the same time; indeed, the latter comes into action automatically if the stalk is pulled for more than half a second.



fig. 98

The wiper stops working a few strokes after releasing the stalk; a further “cleaning stroke”, after a few seconds completes the wiping operation.

Windscreen washer nozzles are fitted with demisting resistors that cut in automatically (for about 3 minutes) when pressing the fast window demisting/defrosting button.

Headlight washer (fig. 99)

Pulling the stalk towards the steering wheel will also operate the headlight washers providing that the dipped beam headlights are on.



fig. 99

IMPORTANT Under certain conditions, when headlight washers are on, the climate control system activates automatically the inside air recirculation to prevent washer fluid smell inlet into the passenger’s compartment.

Rain sensor

The rain sensor is an infrared led sensor installed on the windscreen and combined with the windscreen wiper which automatically suits the flick frequency during operation to the intensity of rain.

All the functions controlled with the right-hand stalk (i.e. on/off, continuous slow and fast wipe, temporary fast wipe, windscreen washer and headlight washer) are unvaried.

The rain sensor is automatically switched on when the stalk is taken to position **1** (fig. 97) and has the purpose of adjusting the range of operation from stationary (no flick) when the windscreen is dry to second continuous speed (continuous fast wipe) when the rain is heavy.

When taking the stalk to **1** to activate the rain sensor, the windscreen wiper indicates the sensor activation by a flick.

IMPORTANT To guarantee proper rain sensor operation, keep the glass clean in the sensor area.

Turning the knurled ring **A** (fig. 100) it is possible to increase the sensitivity of the rain sensor, obtaining a quicker change from stationary (no flick) when the windscreen is dry, to second continuous speed (continuous fast wipe):

- = low sensitivity
- ■ = medium sensitivity
- ■ ■ = high sensitivity
- ■ ■ ■ = max. sensitivity.

Rain sensor sensitivity level increase (with sensor on) is indicated by windscreen wiper flick.

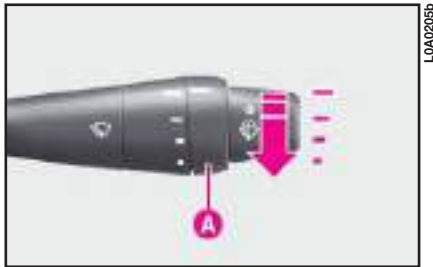

fig. 100

Operating the windscreen washer with the rain sensor activated (stalk at position **1**) the normal washing cycle is performed at the end of which the rain sensor resumes its normal automatic function.

The rain sensor is switched off when the key is turned to **STOP**. It will not come on again at the following engine start-up (key at **MAR**) even if the stalk is at position **1**. This will avoid accidental activation when starting the engine that could result in dangerous situations (e.g. manual windscreen washing, wiper blades sticking due to ice and risk of damaging the windscreen wiper motor). In this case to activate the rain sensor, just take the stalk to position **0** or **2** and then to **1** again, or change sensitivity (increase or decrease) through knurled ring **A**.

When the rain sensor is again activated in this way, at least one windscreen wiper stroke occurs, even if the windscreen is dry, to signal the occurred re-activation.

The rain sensor is located behind the driving mirror in contact with the windscreen and inside the area cleaned by the wiper and it controls an electronic control unit which in turns controls the wiper motor.

At starting, the rain sensor automatically provides to stabilize at about 40°C temperature to eliminate, from the control surface, the possible condensate and to prevent the ice formation.



The rain sensor must be deactivated (or key at STOP) when cleaning the windscreen (e.g. at service stations). The rain sensor must be deactivated also when washing the car manually or at automatic washing stations.



In the event of ice on the windscreen, make sure to have disconnected the device to prevent wiper motor damages.

The sensor rain is able to recognize and automatically adjust itself in the presence of the following particular conditions, which need a different intervention sensitivity:

- impurities on the control surface (salt, dirt, etc.)
- straks of water caused by worn wiper blades
- difference between day and night (the human eye is more disturbed at night by the wet surface of the glass).

Rain sensor failure

In case of sensor malfunctioning, intermittent wiping is activated with the sensitivity level set manually, regardless of the rain.

In this case it is recommended to deactivate the rain sensor and activate continuous wiping (1st or 2nd speed); contact a **Lancia Dealership** as soon as possible.

INSTRUMENT PANEL

PETROL VERSIONS (fig. 101)

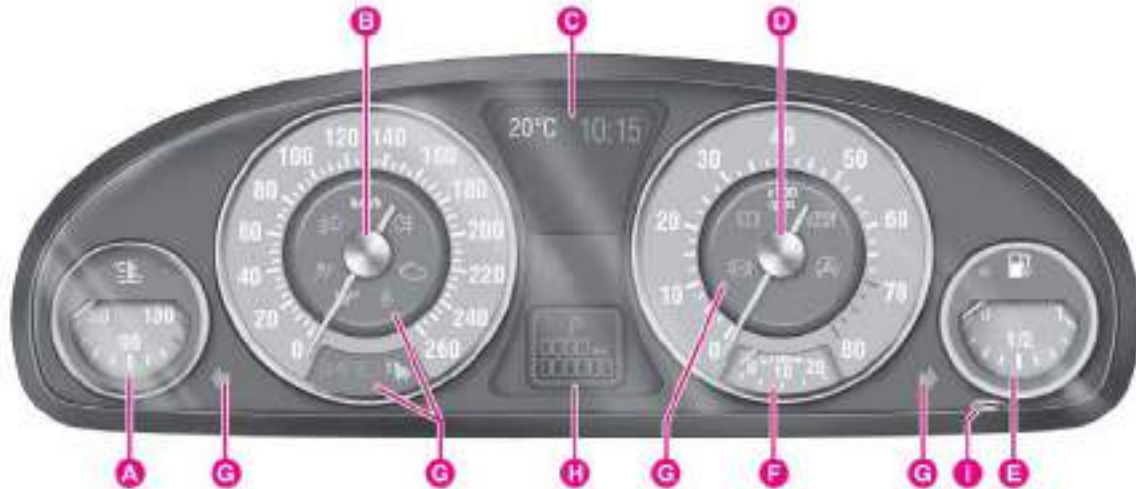

fig. 101

L0A0230b

A - Engine coolant temperature gauge with overheating warning light

B - Speedometer

C - Multifunction display for symbols/messages/failure indications and CONNECT info repetition

D - Engine rev. counter

E - Fuel gauge and reserve warning light

F - Flash consumption gauge

G - Warning lights

H - Kilometre counter (and trip meter) and automatic gearbox

I - Trip meter reset button/failure messages deleting button

JTD VERSIONS (fig. 102)

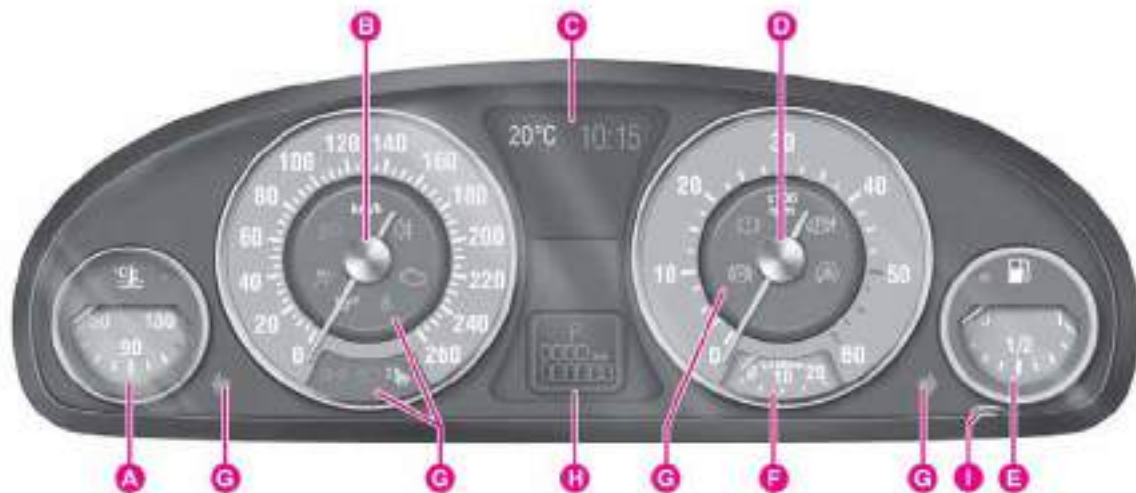

fig. 102

L0A0231b

A - Engine coolant temperature gauge with overheating warning light

B - Speedometer

C - Multifunction display for symbols/messages/failure indications and CONNECT info repetition

D - Engine rev. counter

E - Fuel gauge and reserve warning light

F - Flash consumption gauge

G - Warning lights

H - Kilometre counter (and trip meter) and automatic gearbox

I - Trip meter reset button/failure messages deleting button

INSTRUMENTS

SPEEDOMETER (fig. 103)

The speedometer shows the car speed expressed in kilometres per hour (km/h) and starts signalling the speed when the car speed exceeds approx. 4 km/h (see the indications given in paragraph "At the filling station").



fig. 103

REV COUNTER (fig. 104)

If the needle is in the hazard sector (the section with red lines) it shows that the engine is over-revving. Do not travel with the needle in this sector.

When the engine is idling, the rev counter may show a gradual or sudden increase in engine speed, according to the case. This is normal and indicates the operation of the climate control compressor or fans, etc. In particular, a gradual variation in engine revolution speed safeguards battery charge.



fig. 104

IMPORTANT The hazard sectors can present different widths and different full scale values according to the various car versions.

IMPORTANT The electronic injection control system will progressively cut off the flow of fuel when the engine is over-revving and the engine will consequently lose power.

ENGINE COOLANT TEMPERATURE GAUGE WITH OVER-HEATING WARNING LIGHT (fig. 105)

This instrument indicates the engine coolant temperature. It starts signalling the temperature when this reaches approximately 50 °C.

The needle should usually be on middle scale values. reduce your demand on the engine if the needle approaches top scale values.



fig. 105

The warning light **A** will come on together with message “ENGINE COOLANT TEMPERATURE HIGH” on the instrument panel display to indicate that the coolant temperature is too hot. In this case, stop the engine immediately and contact a **Lancia Dealership**.

IMPORTANT The needle may approach the top scale values if the engine cooling radiator external part is obstructed or dirty. In this case, inspect and remove the obstructions. Accurately clean the external part of the radiator as soon as possible.

FUEL GAUGE AND RESERVE WARNING LIGHT (fig. 106)

The fuel reserve warning light **A** will come on together with message “REFUEL” on the instrument panel display to indicate that there are approximately 10 litres of fuel in the tank.

IMPORTANT Do not travel with the fuel tank almost empty: the gaps in fuel delivery could damage the catalyst.



fig. 106

IMPORTANT Refuelling shall always be performed with engine off and ignition key to **STOP**. If the engine is off but the key is to **MAR**, a wrong fuel level could temporarily be indicated. This is due to the internal system control logic and cannot be considered as a system malfunctioning.

FLASH CONSUMPTION GAUGE (fig. 107)

Gauge A shows the flash consumption: to prevent excessively variable values the gauge shows the average consumption of the last minutes of travel expressed in l/100 km (litres per 100 km).

This is helpful for the driver for learning the fuel consumption in relation to the driving style.

The gauge needle has the following position:

- value 0 l/100 km with car stationary
- near value 2 l/100 km when the car speed is between 4 and 20 km/h and when releasing the accelerator pedal during driving
- actual consumption value (between 2 and 20 l/100 km) for speeds exceeding 20 km/h.



fig. 107

KILOMETRE COUNTER (AND TRIP METER) AND AUTOMATIC GEARBOX

The following information is shown on the display (fig. 108):

- the total number of kilometres driven (six digits on the first line **A**;
- the trip meter reading (four digits) on the second line **B** ;
- engaged or demanded gear (versions with electronic automatic gearbox) on the top of the display **C** .



fig. 108

Press button **A** (fig. 109) for at least two seconds to reset the trip meter.

When pressing the button for less than two seconds, failure message deleting function is activated.

With ignition key at **STOP** or removed, the display is off. When opening or closing a front door, the display comes on displaying trip meter info for about 20 seconds.

IMPORTANT The trip meter reading will be deleted if the battery is disconnected.



fig. 109

MULTIFUNCTION DISPLAY (fig. 110)

The multifunction display shows all the useful information necessary when driving, more particularly:

Information on standard screen

- Clock **A**
- External temperature **B**.



fig. 110

Car conditions

- Scheduled servicing
- Engine oil level (JTD versions only)
- Instrument dimmer
- Failure message display
- Display of warning messages with corresponding symbols (e.g. “WARNING ICE HAZARD”, “ASR OFF”, etc.).

CONNECT information

Information managed by CONNECT:

- AUDIO function info
- NAVIGATOR info (symbol repetition)
- TELEPHONE function info
- VOICE BOX info
- SMS messages reception.

Driver’s aiding system information



- Cruise Control info
- Radar Cruise Control info

The language used for indicating failures and messages on the multi-function display is the same as the CONNECT language (where it is possible to set it).

START-UP CHECKS

When turning the ignition key to **MAR** to start the engine, the system starts monitoring the main car systems, the engine oil level (JTD versions only) and indicates the next Scheduled Servicing.





Check stage

| Warning light/symbol | Message | Meaning of the message | Remarks |
|---|-----------------------|--|---------|
|  | DIAGNOSIS IN PROGRESS | Diagnosis is being performed | – |
|  | OK | Diagnosis is over and all checked devices are OK | – |

Engine oil level check (JTD versions only)

Indication is correct only if oil level has been checked with the car on a level surface.

If oil level is low, before topping up, check it by the proper dipstick as described in paragraph “Checking fluid levels” in the “Car maintenance” chapter.

| Warning light/symbol | Message | Meaning of the message | Note |
|--|---|---|---|
|  | ENGINE OIL LEVEL | Engine oil level indication | If oil level is near or below the MIN reference line top up as soon as possible |
|  | LOW ENGINE OIL LEVEL SWITCH OFF ENGINE DO NOT PROCEED | Engine oil level is below the minimum | Restore proper oil level |
|  | MAXIMUM ENGINE OIL LEVEL | Engine oil level could exceed the maximum | Use the dipstick to check that the oil level is not exceeding the MAX reference line  If oil level is exceeding the MAX reference line contact a Lancia Dealership as soon as possible |

Scheduled Servicing info

Service message is displayed in km or days according to the approaching service interval.

The Service Schedule programmes 9 service operations to be performed every 20,000 km or every year.

Service indications will be displayed starting from 2,000 km or 30 days from this deadline and then are shown again at:

– km: 1.800 - 1.600 - 1.400 - 1.200 - 1.000 - 800 - 600 - 400 - 200 - 100 - 50

– days: 27 - 24 - 21 - 18 - 15 - 12 - 9 - 6 - 3.

IMPORTANT Instrument panel stored info is not deleted if power supply is interrupted.

| Warning light/symbol | Message | meaning of the message | Remarks |
|---|--------------------------------------|---|--|
|  | SCHEDULED SERVICE WITHIN: xxxx km | Indicates the number of kilometres to go before next Scheduled Servicing | Contact a Lancia Dealership to programme the Scheduled Service operation |
| | SCHEDULED SERVICE WITHIN: xx days | Indicates the number of days to go before next Scheduled Servicing | Contact a Lancia Dealership to programme the Scheduled Service operation |
| | SCHEDULED SERVICE EXPIRED: 0 km | Indicates that the car has reached the km required to perform the Scheduled Service operation | Contact a Lancia Dealership as soon as possible to carry out the programmed Scheduled Service operation |
| | SCHEDULED SERVICE EXPIRED: 0 days | Indicates that one year has past since last Scheduled Service operation | Contact a Lancia Dealership as soon as possible to carry out the programmed Scheduled Service operation |

INSTRUMENT PANEL WARNING LIGHTS AND MESSAGES

On the instrument panel are set the main warning lights. Certain warning lights with the relevant warning messages are present also on the instrument panel multifunction display.

Many indications/info are displayed with a symbol only on the multifunction display with the corresponding warnings for the driver.

IMPORTANT Indications may vary according to the car version.

GENERAL NOTES

Failure indications shown on the multifunction display together with buzzer sounding and warning light (if any), are accompanied by specific **warning messages** (e.g. “GO TO DEALER”, “SWITCH OFF ENGINE”, etc.). These indications are **concise** and **cautionary** and are aimed to suggest the **prompt action** the driver must adopt when a car malfunctioning appears. These indications, however, shall not be considered as exhaustive and/or as an alternative to the specifications contained in this Owner Handbook, which shall always be read through carefully and thoroughly. In case of failure indication **always refer to the specifications contained in this chapter.**

Failure indications displayed on the multifunction display are divided into two categories: very serious failures and serious failures. The message and the warning indication corresponding to very serious failures are displayed alternately for few seconds. This “cycle” is repeated indefinitely and it stops any previous indication on the display. It is displayed every time the ignition key is turned to **MAR**, until the cause of malfunctioning is removed. To stop this “cycle”, briefly press (less than two seconds) the trip meter reset button. In this case the failure symbol stays on the display in the central area until the cause of malfunctioning is removed.

The message and the warning indication corresponding to serious failures are displayed alternately for few seconds. This “cycle” is repeated for about 20 seconds and then goes off, but it comes on again every time the ignition key is turned to **MAR**. At the end of the cycle (approx. 20 seconds) when pressing briefly (less than two seconds) the trip meter reset button, the warning symbol is reduced to icon at the bottom of the display and the screen present before the failure returns on the display.



LEFT DIRECTION INDICATOR

The warning light comes on when left direction indicators are on and, together with right direction indicators, when hazard lights are on.



RIGHT DIRECTION INDICATOR

The warning light comes on when right direction indicators are on and, together with left direction indicators, when hazard lights are on.



SIDE/TAILLIGHTS

The warning light comes on when side/taillights or parking lights are on.



DIPPED BEAM HEADLIGHTS

The warning light comes on when dipped beam headlights are on or when flashing the headlights.



FRONT FOG LIGHTS

The warning light comes on when front fog lights are on (where provided).



REAR FOG LIGHTS

The warning light comes on when rear fog lights are on.



AIRBAG SYSTEM FAILURE

Turning the ignition key to **MAR**, the warning light turns on but it should go off after a few seconds. The warning light comes on with message “AIRBAG SYSTEM FAULT” on the multifunction display to indicate an airbag system failure.



If the  warning light does not turn on when turning the ignition key to **MAR** or if it stays on when travelling, (together with message on display) this could indicate a failure in safety retaining systems; under this condition air bags or pretensioners could not trigger in the event of collision or, in a restricted number of cases, they could trigger accidentally. Stop the car and contact Lancia Dealership to have the system checked immediately.



FRONT PASSENGER AIRBAG DEACTIVATED

The warning light comes on when front passenger airbag is deactivated by the relevant key switch.



REAR SIDE BAGS DEACTIVATED (where provided)

The warning light comes on when rear side bags are deactivated by the relevant key switch.



SEAT BELTS

The warning light comes on with ignition key at **MAR** when the driver's seat belt is not fastened.



EOBD ENGINE CONTROL SYSTEM FAILURE

In normal conditions, turning the ignition key to **MAR**, the warning light turns on, but it should go off when the engine has started.

If the warning light stays on or turns on when travelling together with message “ENGINE CONTROL SYSTEM FAULT” on the multifunction display:

Glowing steadily - means a fault in the supply/ignition system which could cause high emissions at the exhaust, possible lack of performance, poor handling and high consumption levels.

In these conditions it is possible to continue driving without however demanding heavy effort or high speeds. Prolonged use of the car with the warning light on may cause damages. Contact a **Lancia Dealership** as soon as possible.

The warning light goes off if the fault disappears but it is however stored by the system.

Flashing - indicates the possibility of damage to the catalyst (see “EOBD system” in this chapter).

If the warning light flashes, it is necessary to release the accelerator pedal to lower the speed of the engine until the warning light stops flashing; continue driving at moderate speed, trying to avoid driving conditions that may cause further flashing and contact a **Lancia Dealership** as soon as possible.



If, turning the ignition key to MAR, the  warning light does not turn on or if it turn on glowing steadily or flashing when travelling, contact a **Lancia Dealership**.



INJECTION SYSTEM FAILURE (where provided - JTD versions)

In normal conditions, turning the ignition key to **MAR**, the warning light turns on but it should go off after a few seconds.

If the warning light stays on or turns on while travelling together with the message “ENGINE CONTROL SYSTEM FAULT” on the multifunction display, this indicates that the injection system is not working perfectly with possible lack of performance, poor handling and high consumption.

In these conditions it is possible to continue driving without however requiring heavy effort or high speed from the engine. In any case, contact a **Lancia Dealership** as soon as possible.

Do not use the car for long periods at high speed with this warning light on since this could result in serious damages especially in case of irregular operation or misfiring.



LOW BRAKE FLUID LEVEL

Turning the ignition key to **MAR**, the warning light turns on but it should go off after a few seconds.

The warning light comes on together with the message “LOW BRAKE FLUID LEVEL” on the multifunction display, when the level of the brake fluid in the reservoir falls below the minimum level, due to possible leak in the circuit.



If the  warning light comes on when travelling, stop immediately and contact a Lancia Dealership.

In the event of instrument panel warning light failure, the warning light on the multifunction display comes on together with message “BRAKE FLUID INDICATOR FAULT”: contact a **Lancia Dealership** as soon as possible.





ABS SYSTEM FAILURE
Turning the ignition key to **MAR**, the instrument panel warning light turns on but it should go off after a few seconds.

When there is failure the warning light stays on or comes on when travelling together with message “ABS SYSTEM FAULT” on the multifunction display. In this case the braking system keeps its effectiveness unchanged, but without the potential offered by the ABS system. It is however recommended to contact a **Lancia Dealership** as soon as possible.

In the event of instrument panel warning light failure, the warning light on the multifunction display comes on together with message “ABS INDICATOR FAULT”: contact a **Lancia Dealership** as soon as possible.



**EBD SYSTEM FAULT
(ELECTRONIC BRAKEFORCE DISTRIBUTOR)**

The car is fitted with electronic braking distributor (EBD). The turning on at the same time of the  and  warning lights on the instrument panel together with message “EBD SYSTEM FAULT” on the multifunction display with the engine running indicates an EBD system failure.



In this case heavy braking may cause the rear wheels to lock before time, with the possibility of skidding, stop the car immediately and contact a Lancia Dealership.



ESP SYSTEM (ELECTRONIC STABILITY PROGRAM) FAILURE

Turning the ignition key to **MAR**, the warning light turns on but it should go off after a few seconds.

If the warning light does not go off or stays on when travelling together with the message “ESP SYSTEM FAULT” on the multifunction display, contact a **Lancia Dealership**.

Warning light flashing when driving indicates that the ESP system is active.

In the event of instrument panel warning light failure, the warning light on the multifunction display comes on together with message “ESP INDICATOR FAULT”: contact a **Lancia Dealership** as soon as possible.





ELECTRIC PARKING BRAKE (EPB)

Turning the ignition key to **MAR**, the warning light turns on but it should go off after a few seconds.



If the  warning light does not go off or stays on when travelling together with the message “EPB FAULT - GO TO DEALER” on the instrument panel display, contact immediately a **Lancia Dealership**.

In case of  instrument panel warning light failure, ! warning light comes on together with message “EPB INDICATOR FAULT - GO TO DEALER” on the multifunction display: contact a **Lancia Dealership** as soon as possible.

MULTIFUNCTION DISPLAY WARNING LIGHTS AND MESSAGES

The following pages give a list of monitored car systems or parameters and the corresponding symbols, failure and warning messages that could be shown on the multifunction display.

The following tables show the failure/warning indications with the corresponding meaning and the proper actions to take.

Indications may vary according to the car version.

Screen A (failure message) and B (warning message) (**fig. 111**) are an example of the indications displayed alternately.



fig. 111

Instrument dimmer

| Warning light/symbol | Message | Meaning of the message | Remarks |
|---|----------------------|--|---------|
| min  max | DIMMER INSTRUMENT | Indicates the set lighting level (for instrument panel, display and buttons) | - |



Steering wheel lock

| Warning light/symbol | Message | Meaning of the message | Remarks |
|----------------------|--------------------------------------|--|---------|
| - | STEERING LOCKED WHEN DOORS CLOSED | Steering will be locked when locking the doors with the remote control | - |

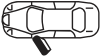

Follow me home device

| Warning light/symbol | Message | Meaning of the message | Remarks |
|----------------------|------------------|---|---|
| - | FOLLOW ME XXs | Indicates that the “Follow me home” device is on, external lights will therefore stay on for the set time | Minimum: 30 seconds, maximum: 210 seconds, 30 seconds intervals |

Doors

| Warning light/symbol | Message | Meaning of the message | Action |
|---|------------|--|---------------------------|
|  | DOOR OPEN | The door indicated by the symbol is not closed correctly | Close the door indicated |
|  | DOORS OPEN | The doors indicated by the symbol are not closed correctly | Close the doors indicated |

Bonnet and boot

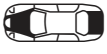
| Warning light/symbol | Message | Meaning of the message | Action |
|---|----------------------|---|-------------------------|
|  | BONNET OPEN | The engine bonnet is not closed correctly | Close the engine bonnet |
|  | BOOT OPEN | The boot is not closed correctly | Close the boot tailgate |
|  | BOOT AND BONNET OPEN | Engine bonnet and boot are not closed correctly | Close bonnet and boot |



Window anti-trap safety system

| Warning light/symbol | Message | Meaning of the message | Action |
|---|--|--|------------------------------------|
|  | WINDOW ANTI-TRAP SYSTEM FAULT FRONT LEFT GO TO DEALER | Front left-hand window anti-trap system sensor fault | Contact a Lancia Dealership |
| | WINDOW ANTI-TRAP SYSTEM FAULT FRONT RIGHT GO TO DEALER | Front right-hand window anti-trap system sensor fault | Contact a Lancia Dealership |
| | WINDOW ANTI-TRAP SYSTEM FAULT REAR LEFT GO TO DEALER | Rear left-hand window anti-trap system sensor fault | Contact a Lancia Dealership |
| | WINDOW ANTI-TRAP SYSTEM FAULT REAR RIGHT GO TO DEALER | Rear right-hand window anti-trap system sensor failure | Contact a Lancia Dealership |

Lancia CODE, Keyless System (CID device) and alarm system

| Warning light/symbol | Message | Meaning of the message | Action |
|---|--|--|--|
|  | ALARM FAULT GO TO DEALER | Alarm system failure | Contact a Lancia Dealership |
| | THEFT ATTEMPTED | Theft has been attempted | See paragraph “Electronic alarm” |
| | VEHICLE PROTECTION SYSTEM FAULT GO TO DEALER | Failures detected in Lancia CODE system | Contact a Lancia Dealership |



Glow plugs (JTD versions)

| Warning light/symbol | Message | Meaning of the message | Remarks / Action |
|---|--|--|---|
|  | – | Symbol is displayed when glow plugs are working. Symbol goes off when glow plugs reach the preset temperature. When outside temperature is high symbol displaying can be unperceivable | Start engine as soon as symbol goes off |
|  | PLUG PREHEATING FAULT GO TO DEALER | Plug preheating system fault | Contact a Lancia Dealership |



Fuel level

| Warning light/symbol | Message | Meaning of the message | Remarks |
|---|---------|--|--|
|  | REFUEL | Low fuel in the tank. This message is displayed when about 10 litres fuel are left in the tank | Top up fuel as soon as possible IMPORTANT Do not travel with the fuel tank almost empty: the gaps in fuel delivery could damage the catalyst |

Outside temperature (ice hazard)

| Warning light/symbol | Message | Meaning of the message | Remarks |
|---|--------------------|---|--|
|  | WARNING ICE HAZARD | Outside temperature is low and there could be ice on the road |  Under certain conditions (bridges, overbridges, curves or road sections in the shade, etc.) the air temperature at ground level can be lower than that at sensor level and therefore there can be ice on the road although this warning message is not displayed |

Airbag

| Warning light/symbol | Message | Meaning of the message | Action |
|---|--|--------------------------|--|
|  | AIRBAG SYSTEM FAULT | Airbag system failure | IMPORTANT If the  warning light does not turn on when turning the ignition key to MAR or if it stays on when travelling, (together with message on display) this could indicate a failure in safety retaining systems; under this condition air bags or pretensioners could not trigger in the event of collision or, in a restricted number of cases, they could trigger accidentally. Stop the car and contact Lancia Dealership to have the system checked immediately. |
| | AIRBAG SYSTEM FAULT SWITCH OFF ENGINE, DO NOT PROCEED | Airbag system failure | |

ABS SYSTEM

| Warning light/symbol | Message | Meaning of the message | Action |
|---|-------------------------------------|--|------------------------------------|
|  | SYSTEM UNAVAILABLE | System setting in progress | - |
| | ABS SYSTEM FAULT GO TO DEALER | ABS system failure: in this case the braking system keeps its effectiveness, but without the potential offered by the ABS system. Drive with the utmost care specially in all cases of less than perfect grip. | Contact a Lancia Dealership |
| | ABS INDICATOR FAULT GO TO DEALER | System is ok but the warning light is failing and cannot indicate the presence of future failures of the ABS system | Contact a Lancia Dealership |



ESP (ELECTRONIC STABILITY PROGRAM)

| Warning light/symbol | Message | Meaning of the message | Action |
|---|-------------------------------------|---|------------------------------------|
|  | SYSTEM UNAVAILABLE | System setting in progress | - |
| | ESP SYSTEM FAULT GO TO DEALER | ESP system failure | Contact a Lancia Dealership |
| | ESP INDICATOR FAULT GO TO DEALER | System is ok but the warning light is failing and cannot indicate the presence of future failures/interventions of the ESP system | Contact a Lancia Dealership |



ASR SYSTEM (wheel antiskid system)

| Warning light/symbol | Message | Meaning of the message | Action |
|---|--------------------|--------------------------------------|--------|
|  | ASR OFF | System has been deactivated manually | – |
| | ASR ON | System has been activated manually | – |
| | SYSTEM UNAVAILABLE | System setting in progress | – |

EBD SYSTEM (electronic brakeforce distributor)

| Warning light/symbol | Message | Meaning of the message | Action |
|---|--|----------------------------|--|
|   | EBD SYSTEM FAULT SWITCH OFF ENGINE, DO NOT PROCEED | EBD system failure | Stop the car and contact a Lancia Dealership |
| | SYSTEM UNAVAILABLE | System setting in progress | – |



The car is fitted with an electronic brakeforce distributor (EBD). The turning on at the same time of the  and  warning lights on the instrument panel together with message “EBD SYSTEM FAULT” on the multifunction display, with engine running, indicates an EBD system failure; in this case heavy braking may cause the rear wheel lock before time, with the possibility of skidding.

EPB (electric parking brake)

| Warning light/symbol | Message | Meaning of the message | Action |
|---|-------------------------------------|---|---------------------------------------|
|  | EPB FAULT GO TO DEALER | Electric parking brake failure | Contact a Lancia Dealership |
| | EPB INDICATOR FAULT GO TO DEALER | Electric parking brake warning light failure | Contact a Lancia Dealership |

EOBD (engine control system)

| Warning light/symbol | Message | Meaning of the message | Action |
|---|--|----------------------------------|---------------------------------------|
|  | ENGINE CONTROL SYSTEM FAULT GO TO DEALER | Engine control system failure | Contact a Lancia Dealership |

Injection system (where provided - JTD versions)

| Warning light/symbol | Message | Meaning of the message | Action |
|---|--|--------------------------|---------------------------------------|
|  | ENGINE CONTROL SYSTEM FAULT GO TO DEALER | Injection system failure | Contact a Lancia Dealership |

Car speed



| Warning light/symbol | Message | Meaning of the message | Action |
|---|--------------------------------------|--|------------------|
|  | SPEED LIMIT EXCEEDED SLOW DOWN | Car speed is exceeding the limit set on the CONNECT | Reduce car speed |

Cruise Control

| Warning light/symbol | Message | Meaning of the message | Remarks |
|---|----------------------|--|---------|
|  | CRUISE CONTROL ON | The Cruise Control (constant speed adjusting device) is activated | - |

Radar Cruise Control

For any information concerning symbols and messages displayed during normal system operation see paragraph “Radar Cruise Control”.

| Warning light/symbol | Message | Meaning of the message | Action |
|---|---|--|---------------------------------------|
| – | RADAR CRUISE CONTROL OFF | The Radar Cruise Control is off | – |
|  | RADAR CRUISE CONTROL ON | The Radar Cruise Control is on | – |
| – | RADAR CRUISE CONTROL NOT ACTIVATED | The Radar Cruise Control was on but has been deactivated since the speed of the preceding vehicles has slowed down to 30 km/h or the brake pedal has been depressed | – |
|  | RADAR CRUISE CONTROL FAULT GO TO DEALER | Radar Cruise Control failure | Contact a Lancia Dealership |
|  | RCC FAULT DIRTY LENS GO TO DEALER | System failure is due to radar sensor “blindness” since the aerial lens is dirty | Contact a Lancia Dealership |

Electronic automatic transmission (COMFORTRONIC)

| Warning light/symbol | Message | Meaning of the message | Action |
|---|--|--|---|
|  | AUTOMATIC TRANSMISSION FAULT GO TO DEALER SLOWLY | Electronic automatic transmission (COMFORTRONIC) failure | Drive slowly to the nearest Lancia Dealership |
| | AUTOMATIC TRANSMIS- SION OIL TEMP. HIGH SWITCH OFF ENGINE, DO NOT PROCEED | Electronic automatic transmission (COMFORTRONIC) oil is too hot | Turn the engine off and contact a Lancia Dealership |

Power steering (VARIOSTEER)

| Warning light/symbol | Message | Meaning of the message | Action |
|---|--|---|---|
|  | POWER STEERING FAULT GO TO DEALER SLOWLY | Power steering (VARIOSTEER) failure | Drive slowly to the nearest Lancia Dealership |

Suspensions (SKYHOOK - where provided)

| Warning light/symbol | Message | Meaning of the message | Action |
|---|--|-------------------------------------|---|
|  | SUSPENSION FAULT GO TO DEALER SLOWLY | Suspensions (SKYHOOK) failure | Drive slowly to the nearest Lancia Dealership |



Headlamp inclination adjustment system

| Warning light/symbol | Message | Meaning of the message | Action |
|--|---|--|--|
|  | HEADLAMP INCLINATION ADJUSTMENT SYSTEM FAULT GO TO DEALER | Headlamp inclination adjustment system failure | Contact a Lancia Dealership |

Brake fluid level

| Warning light/symbol | Message | Meaning of the message | Action |
|--|--|--|--|
|  | LOW BRAKE FLUID LEVEL SWITCH OFF ENGINE, DO NOT PROCEED | Brake fluid in the reservoir is below the minimum level due to possible leak in the circuit | Stop the car and contact a Lancia Dealership |
| | BRAKE FLUID LEVEL INDICATOR GO TO DEALER | Brake fluid warning light failure | Contact a Lancia Dealership |

Engine oil pressure

| Warning light/symbol | Message | Meaning of the message | Action |
|---|--|--|---|
|  | INSUFFICIENT ENGINE OIL PRESSURE SWITCH OFF ENGINE, DO NOT PROCEED | Engine oil pressure is below the standard value | Turn the engine off and contact a Lancia Dealership IMPORTANT If engine has been taxed, when running it idle this message can appear on the dis- play but it should go out when slightly accelerating |
|   | ENGINE OIL PRESSURE SENSOR FAULT GO TO DEALER | Engine oil pressure sensor failure | Contact a Lancia Dealership |



Low battery charge

| Warning light/symbol | Message | Meaning of the message | Action |
|---|--|---|--|
|  | ALTERNATOR FAULT GO TO DEALER SLOWLY | Current generator failure resulting in poor car battery charge | Drive slowly to a Lancia Dealership |

Brake pads

| Warning light/symbol | Message | Meaning of the message | Action |
|---|---------------------------------|------------------------|---|
|  | WORN BRAKE PADS GO TO DEALER | Brake pads are worn | Contact a Lancia Dealership IMPORTANT Since the car is fitted with wear sensors for the front brake pads, when changing them, check also the rear brake pads |

Engine coolant temperature

| Warning light/symbol | Message | Meaning of the message | Action |
|---|--|--|--|
|  | ENGINE COOLANT TEMPERATURE HIGH SWITCH OFF ENGINE, DO NOT PROCEED | Indicates excessive engine coolant temperature | Turn the engine off and contact a Lancia Dealership |
|  | ENGINE COOLANT TEM- PERATURE SENSOR FAULT GO TO DEALER | Engine coolant temperature sen- sor failure | Contact a Lancia Dealership |





Engine coolant level

| Warning light/symbol | Message | Meaning of the message | Action |
|---|---|---|---|
|  | RADIATOR LIQUID INSUFFICIENT SWITCH OFF ENGINE CHECK THE HANDBOOK | Engine coolant level in reservoir is near to the min. level or is below the min. level | Turn the engine off and top up before restarting following the instructions given in chapter “Car maintenance” |





Windscreen washer fluid level

| Warning light/symbol | Message | Meaning of the message | Action |
|---|---|---|---|
|  | LOW WINDSCREEN WASHER FLUID LEVEL CHECK LEVEL | Windscreen washer fluid level in reservoir is below the minimum level | Top up as soon as possible, following the instructions given in chapter “Car maintenance” |





Side/taillights

| Warning light/symbol | Message | Meaning of the message | Action |
|---|---|--|--|
|  | SIDE LIGHT FAULT FRONT LEFT GO TO DEALER | Front left-hand side light doesn't turn on | Contact a Lancia Dealership |
|  | SIDE LIGHT FAULT FRONT RIGHT GO TO DEALER | Front right-hand side light doesn't turn on | Contact a Lancia Dealership |
|  | TAILLIGHT FAULT LEFT GO TO DEALER | Left-hand taillight doesn't turn on | Contact a Lancia Dealership |
|  | TAILLIGHT FAULT RIGHT GO TO DEALER | Right-hand taillight doesn't turn on | Contact a Lancia Dealership |



Direction indicators

| Warning light/symbol | Message | Meaning of the message | Action |
|---|--|--|------------------------------------|
|  | INDICATOR LIGHT FAULT FRONT LEFT GO TO DEALER | Front left-hand direction indicator doesn't turn on | Contact a Lancia Dealership |
|  | INDICATOR LIGHT FAULT FRONT RIGHT GO TO DEALER | Front right-hand direction indicator doesn't turn on | Contact a Lancia Dealership |
|  | INDICATOR LIGHT FAULT REAR LEFT GO TO DEALER | Rear left-hand direction indicator doesn't turn on | Contact a Lancia Dealership |
|  | INDICATOR LIGHT FAULT REAR RIGHT GO TO DEALER | Rear right-hand direction indicator doesn't turn on | Contact a Lancia Dealership |

Brake lights

| Warning light/symbol | Message | Meaning of the message | Action |
|---|---|---|------------------------------------|
|  | BRAKE LIGHT FAULT LEFT GO TO DEALER | Left-hand brake light doesn't turn on | Contact a Lancia Dealership |
|  | BRAKE LIGHT FAULT RIGHT GO TO DEALER | Right-hand brake light doesn't turn on | Contact a Lancia Dealership |
|  | BRAKE LIGHT FAULT LEFT AND RIGHT GO TO DEALER | Brake lights do not turn on | Contact a Lancia Dealership |
|  | BRAKE LIGHT FUSE FAULT GO TO DEALER | Brake lights do not turn on since fuse is blown | Contact a Lancia Dealership |



Rear fog lights

| Warning light/symbol | Message | Meaning of the message | Action |
|---|--|--|---------------------------------------|
|  | REAR FOG LIGHT FAULT LEFT GO TO DEALER | Left-hand rear fog light doesn't turn on | Contact a Lancia Dealership |
|  | REAR FOG LIGHT FAULT RIGHT GO TO DEALER | Right-hand rear fog light doesn't turn on | Contact a Lancia Dealership |
|  | REAR FOG LIGHT FAULT LEFT AND RIGHT GO TO DEALER | Rear fog lights don't turn on | Contact a Lancia Dealership |





Number plate light

| Warning light/symbol | Message | Meaning of the message | Action |
|---|--|--|--|
|  | NUMBER PLATE LIGHT FAULT GO TO DEALER | One or both number plate lights don't turn on | Contact a Lancia Dealership |

Inertia switch (Fuel cut-off switch)

| Warning light/symbol | Message | Meaning of the message | Action |
|---|----------------------|--|--|
|  | INERTIA SWITCH ON | Inertia switch has cut in after an impact/collision |  Before reactivating the switch read care- fully through the instructions given in the re- levant paragraph |

Diesel fuel filter (JTD versions)

| Warning light/symbol | Message | Meaning of the message | Action |
|---|--|---|--|
|  | MOISTURE IN DIESEL FUEL FILTER GO TO DEALER | Water in diesel fuel filter |  The presence of water in the fuel circuit may cause serious damage to the entire injection system and cause irregular engine operation. If there is water in the fuel filter or the sensor is faulty contact a Lancia Dealership as soon as possible |
|   | DIESEL FUEL FILTER SENSOR FAULT GO TO DEALER | Water in diesel fuel filter sensor failure | |

Parking sensors

| Warning light/symbol | Message | Meaning of the message | Action |
|---|---|---------------------------------------|--------------------------------|
|  | PARKING SENSOR FAULT GO TO DEALER | One or more parking sensor failure | Contact a Lancia Dealership |

Twilight sensor

| Warning light/symbol | Message | Meaning of the message | Action |
|---|--|---|------------------------------------|
|  | TWILIGHT SENSOR FAULT GO TO DEALER | The twilight sensor, for switching on/off automatically the external lights is faulty | Contact a Lancia Dealership |

Engine oil level sensor (JTD versions)

| Warning light/symbol | Message | Meaning of the message | Action |
|---|--|---------------------------------|------------------------------------|
|  | ENGINE OIL LEVEL SENSOR FAULT GO TO DEALER | Engine oil level sensor failure | Contact a Lancia Dealership |

Antipollution filter clogged (2.4 JTD 20V CAE version)

| Warning light/symbol | Message | Meaning of the message | Action |
|---|--|-------------------------------|--|
|  | ANTIPOLLUTION FILTER CLOGGED SEE HENDBOOK | Anti-pollution filter clogged | Keep the engine running until the symbol disappears from the display |

Change engine oil (2.4 JTD 20V CAE version)

| Warning light/symbol | Message | Meaning of the message | Action |
|----------------------|----------------------|------------------------|---|
| | CHANGE ENGINE OIL | Change engine oil | Restore proper oil level (see "Checking levels" in section "Car maintenance") |

CLIMATE CONTROL SYSTEM

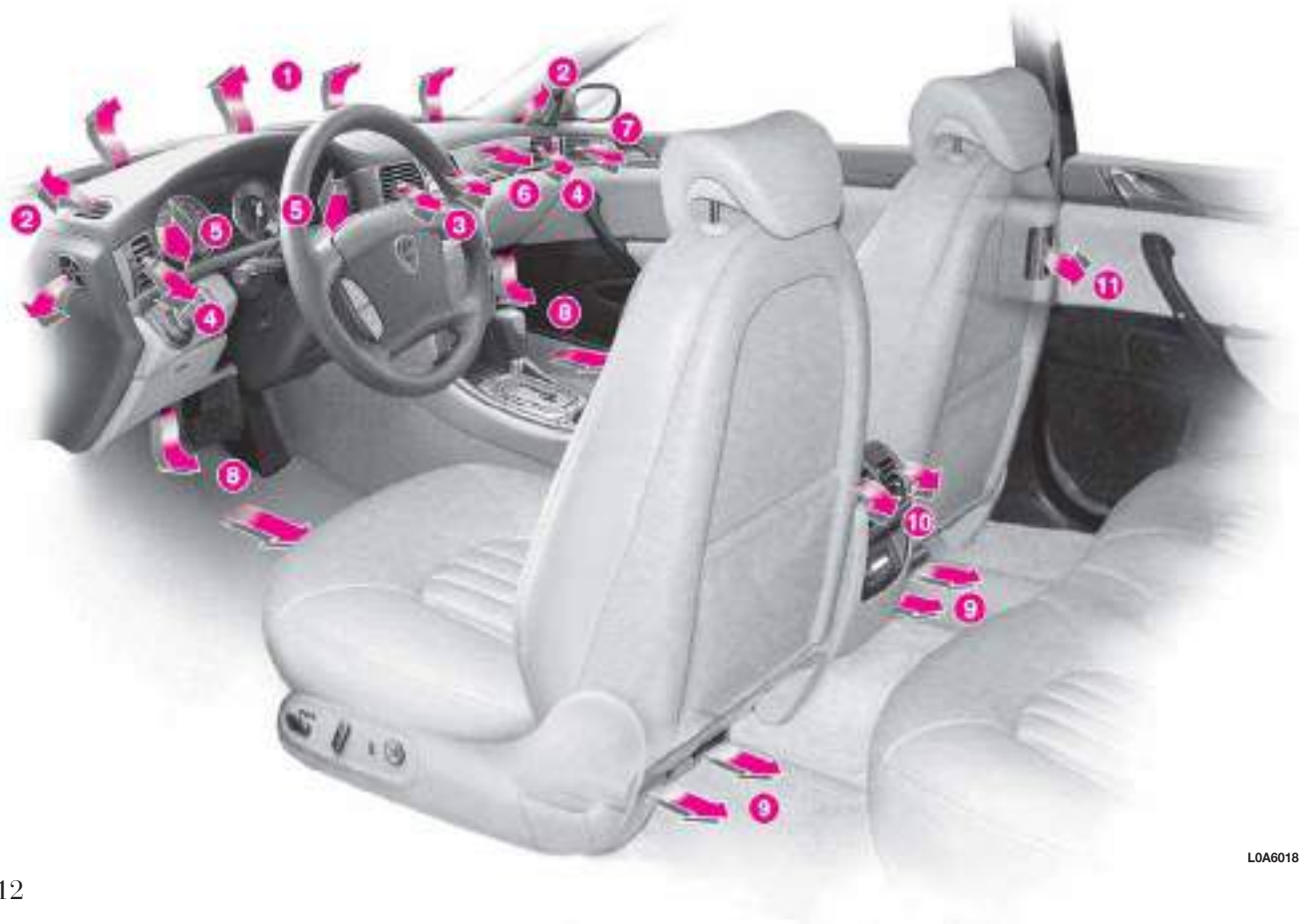

fig. 112

LOA6018b

1 - Windscreen defrosting/demisting vents

2 - Front side windows defrosting/demisting vents

3 - Central directional and adjustable vents

4 - Side directional and adjustable vents

5 - Air vents on driver side

6 - Air vents on passenger side

7 - Directional and adjustable vents on front doors

8 - Front footwell air vents

9 - Rear footwell air vents

10 - Rear central directional and adjustable vents

11 - Rear side directional and adjustable vents

The climate control system can be operated in one of the following ways:

- manually, by selecting the functions by means of the control panel buttons;

- automatically, by means of the system electronic control unit.

The air is let into the passenger compartment through a set of vents on the dashboard, on the front door panels, on the rear central tunnel, on door posts and on the floor as shown in (fig. 112).

DIRECTIONAL AND ADJUSTABLE VENTS (fig. 113-114-115-116-117)

The vents can be turned upwards or downwards and towards the left and the right with control **A**. Front door vents (**fig. 115**) can be turned only upwards or downwards.

The amount of air is adjusted with control **B**:

↗ = all open

● = all closed.

Fixed vents **C** (**fig. 114**) for demisting or defrosting the front side windows are located at the dashboard ends.



fig. 113



fig. 114

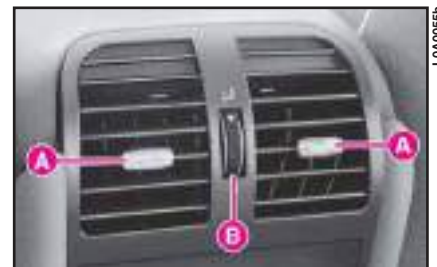

fig. 116



fig. 115



fig. 117

AIR VENTS

The car is fitted with three air vents set on the dashboard: two vents **A** (fig. 118) on driver side and one **B** (fig. 119) on passenger side, sending air in the passenger compartment in a “diffused” mode.

This particular function conveys air at low speed, about half of the usual flow, through additional vents. Moreover, it reduces the air impact on the passengers and the noise due to the air coming out of the vents, thus improving the passengers' comfort.

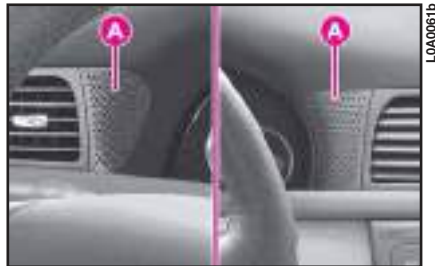

fig. 118



fig. 119



fig. 120

Air vents (open) are actually used only when the control for directing air flow on the instrument panel is operated.

Air vents are opened by rotating the dashboard central vent knobs beyond the upper stop limit (fig. 120):

- control **A** for air vents on driver side
- control **B** for air vent on passenger side.

At the stop limit of these controls there is a button which, if pressed, sends a signal to the climate system control unit.

IMPORTANT When the outside temperature is very high (over 30°C), to reach the selected temperature as soon as possible, it is suggested to operate air vents only after the system has reached steady working conditions.

IMPORTANT On versions equipped with solar cell operated sunroof (where provided), to check operation at first speed of climate control system fan when the car is parked, disengage air vents and set air distribution from central dashboard vents only before leaving the car.

AUTOMATIC CLIMATE CONTROL SYSTEM

GENERAL

The car can be equipped with a two-zone or multi-zone automatic climate control system.

The two-zone climate control system controls temperature, air distribution and flow inside the passenger compartment in two areas: driver side and passenger side.

The multi-zone climate control system controls temperature, air distribution and flow inside the passenger compartment in three areas: driver side, passenger side or back-seat passengers.

Control of front-seat passenger and back-seat passengers is alternated; when the button led **REAR** is turned off, the front-seat passenger control is operating, whereas when button **REAR** is pressed (button led turned on), the back control panel is activated, thus excluding those for the front-seat passenger.

Temperature check is based on the “heat balance” concept, which means that the system works constantly to keep a regular balance between incoming and outgoing heat energy, in order to stabilize temperature inside the passenger compartment and compensate possible variations of outside climate, sun radiance included. For optimal control of temperature in the two areas of the passenger compartment, the system is equipped with a sun ray sensor.

The system features a pollution sensor which can automatically switch the air recirculation function on to reduce the unpleasant effects of polluted air in cities, queues, tunnels and when the windscreen washer is operated (with the characteristic smell of alcohol).

The air quality is controlled by an active carbon dust/pollen filter which has the double function of mechanically filtering the particles dispersed in the air and attenuating the peak accumulation of certain pollutants.

Parameters and functions automatically controlled are the following:

- temperature of air let into driver/passenger vents (front-seat/back-seats);
- air distribution to vents on driver/passenger side (front-seat/back-seats);
- fan speed (continuous variation of air flow);
- compressor activation (to cool air);
- air recirculation.

All these functions can be adjusted manually, it means that one or more system functions can be selected and that it is possible to change their parameters. However, in this way the system is unable to control manually selected functions which will be changed by the system only for safety reasons, while keeping the required temperature.

IMPORTANT During air distribution automatic management, all the air distribution buttons are off. User can select manually any distribution, and only in this case, the concerned button led will be lit.

The manual settings have priority over the automatic settings until the user returns the system to automatic control.

Manual setting of a function does not compromise automatic control of the other functions.

The amount of air let into the passenger compartment does not depend on the car speed. It is in fact adjusted by an electronically controlled fan.

The temperature of the air let into the passenger compartment is always controlled automatically (unless the system is off), according to the temperatures set on the driver's and front/rear passenger's displays.

The following parameters and functions can be adjusted manually:

- air temperature on driver/passenger side (front/rear);
- fan speed (continuous variation);
- air distribution in seven positions (driver/passengers);
- diffused air distribution;
- compressor activation;
- priority of one-zone/two-zone distribution (front/back);
- rapid defrosting/demisting function;
- air recirculation;
- automatic/manual system control;
- heated rear window;
- system off;
- activation of back control panel.

The defrosting/demisting function includes a set of operations enabling to defrost/demist rapidly both the windscreen and the heated rear window.

At each turning off, the system after storing control and function conditions, sets up the open recirculation, thus creating the necessary conditions for operation at first speed of climate control system fan at parking, fed by solar cell operated sunroof (where provided).

IMPORTANT Best operation of climate control system fan at parking, fed by solar cell operated sunroof (where provided), is obtained by closing completely the windows and sunroof. Furthermore, to check operation at first speed of climate control system fan when the car is parked, disengage air vents and set air distribution from central dashboard vents only before leaving the car.

When turning on, the system restores the conditions memorized before turning off, except for the rapid defrosting/demisting function which is reset.

INITIALISING THE AIR CONDITIONING CONTROL UNIT

Whenever the battery is electrically connected again or it is reloaded after being completely flat or after replacing one of the protection fuses, to restore the correct operation of the air conditioning, of the door locking and of the ESP system. It is necessary to perform the initialisation operations contained in the paragraph “If battery is to be disconnected” in the chapter “In an emergency”.

FRONT CONTROL PANEL (fig. 121)

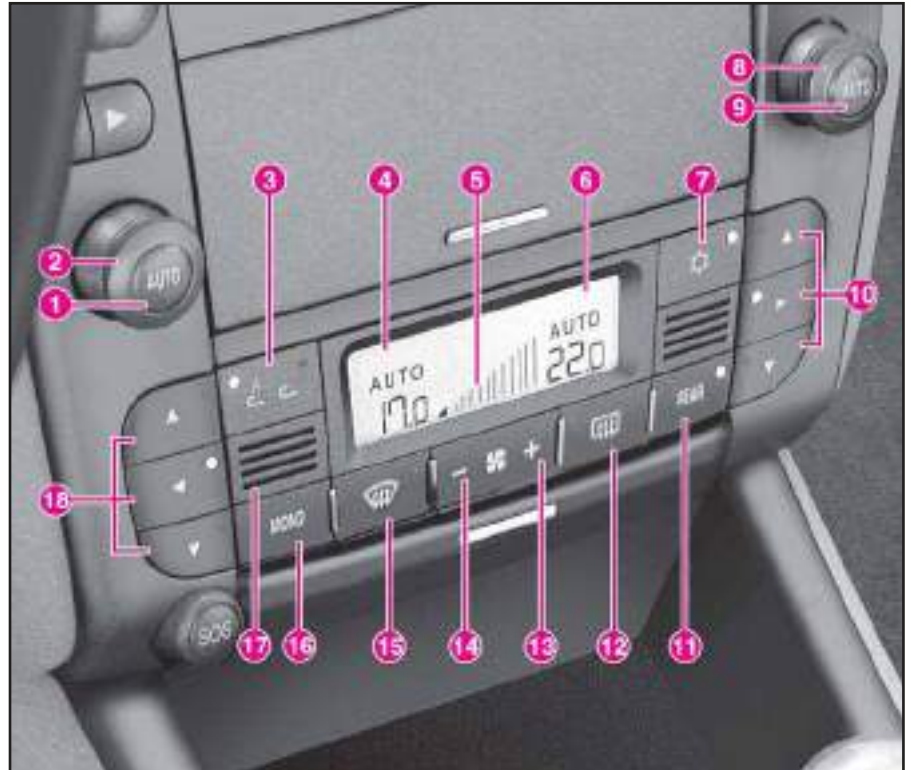

fig. 121

LOA0054b

1 - Button for automatic system selection (driver side)

2 - Inside temperature adjustment knob (driver side)

3 - Air recirculation button (automatic, always turned on or off)

4 - Display for set inside temperature and system status (driver side)

5 - Fan speed display

6 - Display for set inside temperature and system status (passenger side)

7 - Air conditioner compressor off button

8 - Inside temperature adjustment knob (front passenger side)

9 - Button for automatic system selection (front passenger side)

10 - Air distribution buttons (front passenger side)

11 - Button for activation of back control panel

12 - Button for turning on/off heated rear window and defrosting of external rearview mirrors

13 - Button for fan speed increase

14 - Button for fan speed reduction

15 - Button for turning on/off fast defrosting/demisting of windscreen, front side windows, rear window, external rearview mirrors and windscreen wiper nozzles

16 - Button for balancing temperature and air distribution in the passengers' area (front/back-seats) with the driver's area

17 - Inside temperature sensor

18 - Air distribution buttons (driver side)

BACK CONTROL PANEL (fig. 122)

- 1 - Inside temperature adjustment knob (back-seat passengers)
- 2 - Display for set inside temperature (back-seat passengers)
- 3 - Fan speed display
- 4 - System status display (AUTO, FULL AUTO)
- 5 - Button for automatic system selection (back-seat passengers)
- 6 - Button for rear footwell air vents
- 7 - Button for fan speed reduction

- 8 - Button for fan speed increase
- 9 - Button for air distribution through front back vents



fig. 122



The cooling system uses coolant “R134a” refrigerating fluid that meets current regulations and does not pollute the environment if it accidentally leaks. Under no circumstances should other fluids be used which are incompatible with the system components.



HOW TO USE THE CLIMATE CONTROL SYSTEM

The system can be switched on in various ways. We recommend starting by pressing the **AUTO** button and setting the required temperatures on the display.

Since the system controls three areas of the passenger compartment, the driver and the front/back passengers can select different temperature values, with a maximum difference accepted by the system of 7 °C.

In this way, the system will start working fully automatically to reach the required temperature as soon as possible. It will maintain the temperature by adjusting the amount and distribution pattern of the air let into the passenger compartment and manage the recirculation function and the climate control system compressor.

When the system is working automatically, the only possible manual functions are:

- **MONO**, to align air temperature and distribution on the passenger side or in the back-seat passengers' area with that on the driver side;
- **REAR**, to activate the back control panel;
- , to switch off the compressor: in these conditions the system works only as a heater;
- air recirculation, to keep recirculation always turned on or off;
- , for faster defrosting/demisting the front windows, rear window, external rearview mirrors and wind-screen wiper nozzles;
- , for defrosting/demisting the heated rear window and external rearview mirrors.

The temperature, air distribution and fan speed settings can be changed at any time during automatic system operation. The system will automatically adjust to the new request. When the system is fully working in automatic mode (**FULL AUTO**), if air distribution and/or flow is changed, definition **FULL** disappears. In this way functions pass from the automatic mode to the manual mode, until button **AUTO** is pressed again. There is only one fan speed for all the passenger compartment areas and it can be changed also by operating back controls, when activated.

With one or more functions manually on, the air temperature let into the passenger compartment is automatically managed by the system unless the climate control compressor is off. In this condition, in fact, the air inlet into the passenger compartment cannot have a lower temperature than that of the external air.

CONTROLS

Knobs for adjusting air temperature (2, 8 fig. 121 - 1 fig. 122)

Turn the knobs towards the right or towards the left to raise or lower the air temperature required respectively in the front left-hand area (knob 2 fig. 121) and in the front right-hand area (knob 8 fig. 121) or back area (knob 1 fig. 122) of the passenger compartment.

Since the system controls three areas of the passenger compartment, the driver and the front/back-seat passengers can select different temperature values with a maximum difference accepted by the system of 7 °C.

Temperature control in the front passenger area and in the back passenger area is alternated; when the button led **REAR** is off, control of front passenger side is on, but when button **REAR** is pressed (button led on) the back control panel is activated.

The set temperatures are shown on the displays set near the respective knobs.

Press button 16 (**MONO - fig. 121**) to automatically align the (front/back) passenger temperature to the temperature on driver's side. Consequently the temperature in the two areas can be set simply by turning the knob on the driver side 2 (**fig. 121**). This function is provided to facilitate adjusting the temperature in the passenger compartment when only the driver is present. The separate operation of the set temperatures and air distribution is automatically reset when knobs 8 (**fig. 121**) or 1 (**fig. 122**) are turned or button 16 (**MONO - fig. 121**) is pressed again, when the button led is turned on.

Turn the knobs fully to the right or to the left to the end positions **HI** or **LO**, to obtain maximum heating or cooling, respectively:

– **HI** function (maximum heating): this is switched on by turning the temperature knob to the right beyond the maximum value (32 °C). It can be independently switched on from driver's side or from (front/back) passenger's side or from both sides (also by selecting the **MONO** function).

This function can be switched on to speed up heating in the passenger compartment by exploiting the system potential to the maximum. The function employs the maximum coolant temperature while the air distribution and fan speed are set by the system according to environmental conditions. In particular, if the coolant temperature is not sufficient, the function does not switch the fan on at top speed to limit letting into air which is not adequately warm.

All the manually settings can be adjusted when the function is on.

To switch this function off, turn the temperature knob to the left and set the required temperature.

– **LO** function (maximum cooling): it is activated by turning the temperature knob to the left beyond the minimum value (16 °C). It can be independently switched on from driver's side or from (front/back) passenger's side or from both sides (also by selecting the **MONO** function).

This function can be switched on to speed up cooling the passenger compartment by exploiting the system potential to the maximum. This function cuts out the heater and switches the air recirculation and the climate control compressor on. The air distribution and the fan speed are selected according to the environmental conditions. All the manually settings can be adjusted when the function is on. To switch this function off, turn the temperature knob to the right and set the required temperature.

Buttons for adjusting front air distribution (10, 18 fig. 121)

Press these buttons to manually select one of the seven possible air distribution patterns in the front passenger compartment (right and left side):

↑ Air flow to windscreen and front side window vents for defrosting/demisting the windows.

↔ ↔ Air flow to central and side dashboard vents and the rear vents.

IMPORTANT On versions equipped with solar cell operated sunroof (where provided), to check operation at first speed of climate control system fan when the car is parked, disengage air vents and set air distribution from central dashboard vents only before leaving the car.

↘ Air flow to the front and rear footwells. The air distribution pattern, due to the natural tendency of heat to move upwards, allows to heat the passenger compartment up as fast as possible. Furthermore, it offers a prompt feeling of warmth to the coolest parts of the body.

↕ Air flow shared between footwell vents (warmer air) and central and side dashboard vents and the rear vents (cooler air). This air distribution pattern is particularly useful in middle seasons (spring and autumn) when it is sunny.

↑ Air flow shared between the footwell vents and the windscreen and front side window defrosting/demisting vents. This air distribution pattern ensures a good heating of the passenger compartment and prevents possible misting up.

↕ Air flow distribution between central and side dashboard vents, rear vents and windscreen and front side window vents.

↘↕↗ Air flow distribution between all passenger compartment vents.

Air distribution setting is displayed when leds relevant to the selected button are lit, which will be turned off in case of fully automatic operation (**FULL AUTO**).

When a combined function is set, if a button is pressed the main function of the button pressed is activated, together with those already set. If the button corresponding to a function which is already on is pressed, such function will be cancelled (the related led turns off).

Press the **AUTO** button to restore air distribution control after a manual setting.

When the driver selects the air distribution to the windscreen, also the passenger side air flow is automatically directed to the windscreen. Anyway, the passenger can select another air distribution pattern, by pressing the related buttons.

Buttons for adjusting rear air distribution (6, 9 fig. 122)

When the back control panel is activated, it is possible to set one of the three air distribution patterns for the passenger compartment back area by pressing the related buttons:

⇨ Air flow to back central vents.

⇩ Air flow to rear footwells. This air distribution pattern, due to the natural tendency of heat to move upwards, offers a prompt feeling of warmth to the coolest parts of the body.

⇨⇩ Air flow shared between rear footwell vents (warmer air) and central rear vents (cooler air).

Air distribution setting is displayed when leds relevant to the selected button are lit, which will be turned off in case of fully automatic operation (**FULL AUTO**).

When a combined function is set, if a button is pressed the main function of the button pressed is activated, together with those already set. If the button corresponding to a function which is already on is pressed, such function will be cancelled (the related led turns off).

Press the **AUTO** button to restore air distribution control after a manual setting.

Buttons for adjusting fan speed (13, 14 fig. 121 – 7, 8 fig. 122)

Press respectively front control buttons **13** or **14** (fig. 121) and back control buttons **8** or **7** (fig. 122) to increase or decrease the fan speed so to adjust the amount of air let into the passenger compartment while keeping the required temperature constant.

The fan speed is indicated by the bars which light up on the front display **5** (fig. 121) and rear display **3** (fig. 122), when the back control panel is active. Repeatedly press button or keep pressed **13** (fig. 121) or **8** (fig. 122) to switch the fan on at top speed (all bars on).

Repeatedly press or keep pressed button **14** (fig. 121) or **7** (fig. 122) to switch the fan on at minimum speed (one bar on).

When the fan minimum speed is set up (one bar on), by keeping pressed for at least two seconds button **14** (fig. 121) or **7** (fig. 122), the climate control system is deactivated and all the fan bars on the display turn off; **OFF** message is displayed.

The fan speed can be adjusted manually through both the front control panel and the rear control panel, but it is the same one for the whole passenger compartment.

IMPORTANT Press the **AUTO** button to restore air distribution control after a manual setting.

AUTO buttons (automatic operation) (1, 9 fig. 121 - 5 fig. 122)

Press the **AUTO** button on the driver side and/or front/back-seat passenger side: the system will automatically control the air amount and distribution pattern in the related passenger compartment areas and will cancel all the previously made settings. This condition is marked by the message **FULL AUTO** on the system front and rear display, besides the leds on the air distribution buttons turning off.

If one of the functions automatically controlled by the system (air recirculation, air distribution, fan speed or air conditioner compressor deactivation) is manually adjusted, the message **FULL** on the display turns off to indicate that the system is no longer controlling the functions independently (apart from temperature control that is always automatic).

Should the system, as a result of manual settings, no longer be able to assure the selected temperature in the various passenger compartment areas, the selected temperature value starts flashing to indicate the system difficulty and the message **AUTO** automatically turns off.

To restore the system automatic control at any moment after one or more manual setting, press button **AUTO**.

MONO button (set temperature and air distribution alignment) (16 fig. 121)

Press the **MONO** button to automatically align the front/back-seat passenger's side temperature and air distribution to the temperature air distribution on driver's side. Consequently, the temperature and air distribution in the two areas can be set simply by turning the knob on driver's side. This function is provided to facilitate adjusting the temperature in the passenger compartment when only the driver is present.

To restore separate temperature and air distribution control in the two passenger compartment areas, rotate knob **8** (fig. 121) or **1** (fig. 122) to set up temperature in the front/back-seat passengers' area or press again button **MONO 16** (fig. 121) when the button led is on.

REAR button (rear control panel activation) (11 fig. 121)

Press the **REAR** button to switch the rear control panel on and to cut out the front control panel. As a result, back-seat passengers can select temperature, air distribution and fan speed according to their needs.

When rear controls are activated, the led on button **REAR** is on.

IMPORTANT The fan speed can be adjusted manually also by the rear control panel, when activated, but it is the same one for the whole passenger compartment.

The climate control system can be deactivated also by the rear control panel, when operating: press repeatedly or keep pressed button **7** (**fig. 122**) until all the fan bars on the display turn off and message **OFF** is displayed.

To exclude the rear control panel, press again button **REAR**; the button led turns off and the front-seat passenger's controls are operating again.

Air recirculation on/off button **(3 fig. 121)**

The air recirculation function is controlled according to three strategies:

- automatic operation (button left led on);
- forced ventilation on (recirculation always on), the right led on the button will come on;

– forced deactivation off (recirculation always off, air taken from the outside), both leds on the button will go off.

The three conditions are obtained by pressing the air recirculation button **3** in sequence.

When the air recirculation function is automatically controlled by the system, the left led on the air recirculation button is turned on, while the right led is on or off according to the actual recirculation conditions (on or off).

During automatic operation, the recirculation function is automatically switched on when the pollution sensor detects the presence of polluted air, e.g. in cities, queues, tunnels and during windscreen wiper operation (due to the characteristic smell of alcohol).

In addition, if the compressor is on and the outside temperature is over 5 °C, to prevent air polluted by exhaust gases getting inside the passenger compartment during stops, the system stops air recirculation when the car speed is lower than 6 km/h. When the car speed returns over 12 km/h, the system restores the previous conditions.

After using the air recirculation function for a long time (over 15 consecutive minutes), the system automatically stops it for safety reasons, thus letting air be changed.

When air recirculation manual control is set (button left led off), message **FULL** on the display is off.

IMPORTANT The air recirculation function will allow, according to the system operation (i.e. heating or cooling) to reach the required conditions faster. We recommend not turning on this function on rainy and/or cold days as this will considerably increase window misting, especially if the climate control system is off.



In particular climate conditions (e.g. low outside temperature or high humidity) and with the inside air recirculation automatic control on, windows could start misting up. In this case, press the air recirculation button and set it to forced open position (both button leds off), and increase air flow to the windscreen, if required.

Climate control system compressor off button (7 fig. 121)

Press the ☼ button, when the button led is on, to switch the air conditioner compressor off. The led will go off. By pressing again the button when the led is off, the system automatic control of the compressor activation is restored; this situation is indicated by button led lighting up.

When the air conditioner compressor is off, if the system is no longer able to keep the requested temperature, the message **FULL AUTO** on the display turns off and the system deactivates air recirculation to prevent window misting up. Instead, if the system is still able to maintain the requested temperature, the message **FULL** on the display will stay on.

IMPORTANT Air at a temperature lower than that of the outside air cannot be let in to the passenger compartment when the compressor is off. Furthermore, in particular environmental conditions, the windows could mist up fast because the air is no longer dehumidified.

The setting will be stored when the engine is stopped. Either press ☼ button again or press the **AUTO** button to reset automatic control of the compressor (in the latter case, the manual settings will be cancelled). The led on the ☼ button will go out.

The air let into the passenger compartment cannot be cooled when the compressor is off. Consequently:

- if the outside temperature is lower than the set temperature, the system works normally and can reach and maintain the set temperature also when the compressor is off;
- if the outside temperature is higher than the set temperature, the system cannot reach the required temperature. This will be signalled by flashing the external temperature value on the display.

When the compressor is off, it is possible to reset manually the fan speed; on the contrary, when the compressor is on and the engine is running, manual ventilation cannot be lower than the bar indicated on the display.

Button for fast windscreen demisting/defrosting (15 fig. 121)

Press this button: the climate control system will automatically switch on all the functions required for fast windscreen and side window demisting/defrosting, that is:

- climate control system compressor on;
- air recirculation off (if on);
- maximum air temperature **(HI)** on both displays;
- fan speed according to engine coolant temperature in order to limit letting cold air into the passenger compartment for demisting the windows;
- air flow directed to the windscreen and front side window vents;
- heated rear window, external rearview mirror and windscreen nozzle resistances on.

The fast windscreen demisting/defrosting function stays on for approx. 3 minutes after the engine coolant temperature exceeds 50 °C (petrol versions) or 35 °C (diesel versions).

When the fast demisting/defrosting function is on, the led on the related button and that on the heated rear window button are lighted, while both leds on the air recirculation button and that on button  turn off. Message **FULL AUTO** on the display will turn off.

Only the fan speed can be adjusted and the heated rear window can be switched off when the fast demisting/defrosting function is on.

Press the fast demisting/defrosting button again or air recirculation button or compressor off button to switch the fast demisting/defrosting function off and reset the previous system operation conditions as well as the last set function.

Button for demisting/defrosting the heated rear window and external rearview mirrors (12 fig. 121)

Press this button to switch on the heated rear window and external rearview mirror demisting/defrosting function. The led on the button will come on.

The device will be automatically switched off after ten minutes. Press the button again or stop the engine to switch the function off. It will not start up automatically when the engine is started again.

IMPORTANT Do not apply stickers on the electrical filaments of the heated rear window inside part to prevent damage.

OFF button (system off)

The switch the climate control system off, keep pressed for at least two seconds the fan button **14 (fig. 121)** on the front control panel or button **7 (fig. 122)** on the rear control panel; all the fan bars on the display turn off and the message **OFF** will be displayed. The right led on the air recirculation button will come on.

The climate control system conditions when the system is off are:

- air recirculation and compressor off button leds off;
- set temperature displays off;
- air recirculation on, thus isolating the passenger compartment;
- climate control system compressor off;
- fan off.

The heated rear window can be switched on and off normally when the system is off.

IMPORTANT The windows may mist up fast when the climate control system is off and in certain environmental conditions.

The climate control system electronic control unit stores the system settings made before the system was switched off and restores them as soon as a button is pressed (with the exception of the heated rear window button). The function which the button corresponds to will be switched on, if it was off when the system was switched off. It will be kept if, on the other hand, it was on when the system was switched off.

Press the **AUTO** button to switch the climate control system back on and ensure a totally automatic control.

ACTIVE CARBON DUST/POLLEN FILTER

The filter has the specific capacity of combining a mechanical air cleaning action and an electrostatic effect so that the air let into the passenger compartment is purified from particles such as dust, pollen, etc.

In addition to this function, the filter efficaciously reduces the concentration of pollutants thanks to a layer of active carbon inside the filter.

The filtering action is carried out on the air let in from outside (recirculation off).

Have the filter checked at least once a year at a **Lancia Dealership**, ideally at the beginning of the summer.

You should have the filter checked and if required replaced more frequently if the car is mainly used in polluted or dusty areas.



The efficacy of the climate control system may be considerably reduced if the filter is not replaced.

VENTILATION DURING A STOP

In versions with sunroof, the roof top features 21 photovoltaic cells supplying a maximum power of 24 W to supply the climate control system fan when the car is parked with the roof closed or horizontally pivoting.

Fan actuation is automatic and air distribution corresponds to the latest setting made before switching the car off.

This function is useful especially on summer days since it greatly reduces the temperature inside the passenger compartment as well as the duration of the cooling cycle after car start-up, thus avoiding the accumulation of warm air in the air conditioning unit lines.

IMPORTANT Best operation of the fan when the car is parked is obtained by closing completely the windows and sunroof. Furthermore, to check operation at first speed of the fan, disengage air vents and set air distribution from central dashboard vents only before leaving the car.

SUPPLEMENTARY HEATER (where provided)

The supplementary heater can work with the engine off or on and it allows the following:

- to heat the engine coolant before start up
- to reduce the engine warming up time after cold starting
- to warm up the passenger compartment before departure
- to remove ice or condensate from the windows.

Using the heater in winter has the following advantages:

- to reduce engine wear
- to reduce polluting emissions
- to improve comfort during driving and stops
- to improve safety.

The supplementary heater function is useful to integrate the engine coolant warming up during driving in order to reach and keep the optimal working temperature of the passenger compartment heater in the quickest way, especially if the climate is extremely cold.

The system is composed of:

- a heating unit
- an electric pump for the engine coolant circulation
- an exhaust pipe with muffler
- an electric pump metering the fuels
- a fuel delivery pipe
- a sensor for outside air temperature.

The system is connected to the car through the engine cooling system, the fuel system and the electric system. The coolant coming out from the engine is conveyed to the heater and made flow in the circuit by an electric pump. The heater burner is supplied with the car fuel taken directly from the tank by means of an electric pulse pump and then conveyed to the appropriate system pipe. The heater control unit supplies directly both electric pumps (fuel and coolant), activates and checks the heater functions.

The supplementary heating system works both with the engine running and the engine stationary. These two conditions determine the type of system operating mode:

- when the engine is stationary the supplementary heater can work in “programmable heater” or “parked-car heater” mode;

– when the engine is running the system works only in “supplementary heater” mode.

Regardless of the operating mode, the start up procedure for the supplementary heater, once it has been activated, is the following:

1 - Fan activation for comburant air, for at least 30 seconds, to ventilate and oxygenate the combustion chamber. The fan speed is progressively increased until the average operating value is reached.

2 - After about 30 seconds, the heater control unit activates the electric pump metering the fuel and the comburant air fan is deactivated for at least 3 seconds, in order to facilitate fuel burning. A spark plug starts combustion inside the heater.

3 - At this point, there is a combustion stabilizing phase which lasts around 15 seconds, during which the fan speed is kept at average level.

4 - In the following 50 seconds the control unit makes the fan reach nearly its highest speed.

5 - Once combustion has stabilized, the heater control unit deactivates the plug and the fan reaches its maximum speed.

6 - From now on the plug is used by the system as a combustion and flame sensor.

7 - Regardless of the operating mode, the heater extinction procedure is always based on the combustion chamber ventilation for about 30 seconds, in order to eliminate completely any combustion remainder.

IMPORTANT After switching the system off, both automatically or manually, it can be switched on again (ON) only approx. 3 minutes after or when the CONNECT message “COOLING DOWN” disappears from the display.

IMPORTANT Although in a lesser quantity the heater burns fuel as the engine. Therefore, to prevent poisoning and suffocation the supplementary heater shall never be turned on, even temporarily, in confined areas like garages and workshops not equipped with exhaust fans.

IMPORTANT The heater must always be turned off during refuelling and at filling stations to prevent the risk of explosions.

IMPORTANT Do not park the car over flammable materials like paper, grass or dry leaves: risk of fire.

OPERATION WITH ENGINE STATIONARY

“Programmable heater” mode

With this operating mode, the system heats the engine coolant and the passenger compartment before starting the engine, it keeps air recirculation closed and activates air distribution to the windscreen and the floor by operating the passenger compartment fan.

This function can be activated with the **CONNECT** (from the main **SETUP** screen) or with the remote control.

The system works with this mode on if the following conditions are present

- outside temperature lower than 20 °C
- coolant temperature lower than 50 °C
- ignition key at **STOP** or removed
- car battery charged
- fuel not in reserve.

When this mode is on, the heater is deactivated when one of the following conditions occur:

- end of planned working time
- OFF signal from the remote control
- manual shutdown by the user through **CONNECT**

– ignition key at **MAR**

– partial battery rundown

– fuel in reserve

– malfunction detected by the heater control unit.

Timed heater activation/ deactivation through CONNECT

Timed heater activation and deactivation can be set through the **CONNECT**. Select and confirm “Heater” on the main **SETUP** screen to display the parked-car heater settings.

Settings available are the following:

- Operate now
- Timer 1
- Timer 2.

To activate/deactivate the required function, select and confirm it with the **CONNECT** right knob.

“Operate now”

The option “Operate now” enables to warm the passenger compartment with the engine stopped and warm and the ignition key to **MAR**, using the engine coolant, heater coolant circulation pump, automatic air distribution control (if not set manually) and closing air recirculation. The timer cannot be programmed when this function is on.

To guarantee the required comfort, this function shall be mainly activated when coolant is hot enough. When coolant temperature is lower than 50 °C the control unit starts the heater, and when temperature is over 70 °C, the control unit turns the heater off and lets only the coolant circulation pump keep on working.

The “parked-car heater” mode is automatically deactivated when one of the following conditions takes place:

- engine started
- limit time (around 30 minutes) of heater and/or coolant pump functioning overcome
- turn off requested by the user through the CONNECT
- malfunction detected by the heater control unit
- partial battery run-down or alternator fault.

“Timer 1” and “Timer 2”

The “Timer” options shall be used to programme two heater daily cycles; for each cycle enter the time of activation and the length of operation both with 5 minute intervals.

Each cycle cannot last more than 60 minutes. The default operation is 15 minutes. The timer works regardless of the ignition key position.

During heater operation, messages referred to the following conditions are shown on CONNECT display:

- fuel level in reserve (continue anyway?)
- fuel level in reserve. Parked-car heater has been switched off
- parked-car heater not operating because of cooling down
- parked-car heater not operating because external temperature is higher than 20 °C
- parked-car heater not operating because motor is on
- parked-car heater has been switched off because of low voltage.

IMPORTANT For safety reasons, the timer must be programmed/confirmed at any activation and confirmed not later than 24 hours since programming. In addition, the user must confirm every time the timer activation. The timer does not automatically correct standard time.

The timer can be in one of the following conditions:

- off: in this condition the timer is programmable and parameters can be loaded or adjusted. Loaded parameters should be valued and approved by CONNECT
- on: activated parameters approved by CONNECT are stored in the memory. The user confirms the set cycle waiting for the programmed activation moment which is indicated on the CONNECT display
- active: the heater is working in “programmable heater” mode controlled by the timer present on the CONNECT display. When the timer is activated, the CONNECT records the system conditions

– stationary: with the “programmable heater” mode controlled by the timer, the system conditions are controlled by CONNECT.

The timer is automatically deactivated if:

– the “programmable heater” mode function is stopped by CONNECT if, at the timer start, the “programmable heater” mode is activated with the remote control

– if the user manually activates the heater during the timer operation

– if the timer is activated within 3 minutes after the previous heater shutdown

– if the user manually deactivates the timer

– if the fuel level in the tank is low when the timer is activated. This condition is indicated with a message coming from the system and the user must confirm activation. If the user does not confirm activation, the timer is deactivated. The fuel level is indicated by the CONNECT; if this information is not available, it is taken into consideration the last record before stopping the engine

– if the timer is activated when the heater operated by the remote control is activated.

IMPORTANT If the heater is in prompt operating mode, the timer is automatically stopped at the moment of activation. Parameters set with the timer are stored in the memory. If the timer has been deactivated or stopped, it should be manually reactivated by the user.

HEATER ACTIVATION/ DEACTIVATION WITH THE REMOTE CONTROL (fig. 123)

Activation/deactivation of the heater can be operated with remote control A.

The activation signal is issued by the remote control with a range of around 600 meters and picked up by a specific antenna placed on the car, then it is transmitted to the supplementary heater receiver and sent to CONNECT.

IMPORTANT The maximum remote control range is reached on open land, while it is reduced in the presence of buildings.



fig. 123

This control is accepted by **CONNECT** only if:

- outside temperature lower than 20 °C
- coolant temperature lower than 50 °C
- the ignition key is at **STOP** or removed
- car battery charged
- sufficient fuel level
- the timer is deactivated.

Switching the heater on

To switch the heater on, press the remote control button **ON** for 1 or 2 seconds, while keeping the antenna in vertical position; the positive or unsuccessful activation is indicated by the remote control red led **B** in the following way:

- the led turns on for about 2 seconds = the signal has been correctly received and the heater has been activated

- the led flashes for about 2 seconds = the signal has not been received.

In the latter case you are advised to move before trying to activate it by pressing again the **ON** button.

After the confirmation activation, the led **B** will flash every 2 seconds for the whole operation cycle duration.

IMPORTANT If led **B** turns on with green colour, press twice both remote control buttons **ON** and **OFF** within 1 second to set the red colour.

Activation length

When pressing the remote control button **ON** the last recorded activation length is always activated.

To see the recorded length, press at the same time for three consecutive times within 1 second, the remote control buttons **ON** and **OFF**, count the number of flashes of led **B** then compare them to those shown in the table below, including also the first flash appearing the third time you press the buttons.

Default activation length is 30 minutes but it can be changed through the following procedure:

- press at the same time for three consecutive times within 1 second, the remote control buttons **ON** and **OFF**
- count the number of flashes of led **B** including also the first flash appearing the third time you press buttons **ON** and **OFF**
- press **OFF** to set the length successive to the set one (press **OFF** for several times to set the required length in sequence)
- wait for about 10 seconds for timer storing.

| Number of flashes of led B | Heater activation length |
|----------------------------|--------------------------|
| 1 | 10 minutes |
| 2 | 20 minutes |
| 3 | 30 minutes |
| 4 | 40 minutes |
| 5 | 50 minutes |
| 6 | 60 minutes |

Keep the **ON** and **OFF** buttons pressed for about 10 seconds, until led **B** turns off, to reset the 30 minutes standard operation length.

Switching the heater off

To turn the heater off, press the remote control button **OFF** for 1 or 2 seconds, while keeping the antenna in vertical position; the positive or unsuccessful deactivation is indicated by the remote control red led **B** in the following way:

- the led comes on for about 2 seconds = the signal has been received correctly and the heater has been deactivated

- the led flashes for about 2 seconds = the signal has not been received.

In the latter case you are advised to move before trying to deactivate it by pressing again the **OFF** button.

Checking and replacing the batteries

To check the battery charge, press **ON** or **OFF**: if after about 5 seconds led **B** comes on with orange colour it means that the batteries are nearly down and that they shall be replaced.

The batteries must be replaced with new ones of the same type, available at the usual sellers.

Replacing the batteries



Used batteries pollute the environment. Dispose of them in the special containers as specified by current legislation. Keep batteries away from open flames and high temperatures. Keep away from children.

The batteries must be replaced with new ones of the same type, available at the usual sellers.

To replace batteries:

- remove the remote control cover by pushing it in the arrow direction indicated on the cover
- remove exhausted batteries and take note of their position
- fit the new batteries with pole (+) towards the remote control antenna
- fit down the cover.

Request for additional remote controls

The heater receiver will acknowledge up to three remote controls. To order new remote controls, or to replace the original one, contact a **Lancia Dealership**.

OPERATION WITH ENGINE RUNNING

“Supplementary heater” mode

This operating mode integrates the engine coolant warming up, immediately after start up or during driving, to reach and keep the optimal working temperature of the engine and the passenger compartment heater in the quickest way.

This mode is activated automatically by the climate control unit when the following conditions occur at the same time:

- ignition key at **MAR**
- engine running

- coolant temperature lower than 30 °C

- the climate control unit detects (according to sensor detected temperatures) that fast passenger compartment warming is required.

This mode is automatically deactivated when one of the following conditions occurs:

- coolant temperature higher than 70 °C
- the heater control unit detects a fault in the supplementary heater
- engine off.

TECHNICAL SPECIFICATIONS

| | |
|-----------------------|---|
| Maximum heat power | about 5 kW |
| Reduced heat power | about 2,5 kW |
| Rated voltage | 12 V |
| Operating current | 45W to 13.5V; 34W to 12V |
| Idle current | 1mA (5mA with radio receiver) |
| Operating voltage | 10,25V ± 0,25V ÷ 15,50V ± 0,25V |
| Operating temperature | - 40° C ± 2K to 70° C ± 2K |
| Fuel consumption | with reduced power 0,25 Kg/h with maximum power 0,5 Kg/h |
| Weight | 2,9 Kg |
| Noise | 51 db. |

CONTROLS

HAZARD LIGHTS (fig. 124)

These come on when switch **A** is pressed, regardless of the position of the ignition key.

When these lights are on, the switch and the direction indicator warning lights on the instrument panel flash.

Press the switch again to turn the lights off.

IMPORTANT The use of hazard lights is governed by the traffic regulations of the country where the car is being driven. These laws should be complied with.



fig. 124

FRONT FOG LIGHTS (fig. 125) (where provided)

Press button **A** to switch the fog lights $\neq 0$ on (when the outside lights are on).

When front fog lights are on, the warning light 5 on the instrument panel turns on.

When driving, if side lights are turned off while front fog lights are on, the fog lights turn off as well and will be lighted up again after side lights have been turned on again.

The fog lights will be automatically switched off when the ignition key is turned to **STOP** and will not come on again when the engine is started unless button **A** is pressed.



fig. 125

Press again button **A** to switch the lights off.

IMPORTANT The use of front fog lights is governed by the Highway code. The front fog light system complies with EEC/ECE standards.

REAR fog lights (fig. 126)

These lights are switched on by pressing button **A**, when the dipped beam headlights and/or front fog lights are on.

When rear fog lights $\neq 3$ are turned on, panel warning light 4 will come on.



fig. 126

The rear fog lights will automatically be switched off when the engine is stopped or when switching off the dipped beam headlights or the front fog lights. Press the button again to switch the lights on after starting the engine again or switching on the dipped headlights or the front fog lights.

IMPORTANT The rear fog lights may annoy the drivers following you when visibility is good. Consequently, use the light only when required.

IMPORTANT Follow the local prescriptions governing the use of rear fog lights. The rear fog light system complies with EEC/ECE standards.

INSTRUMENT DIMMER (fig. 127)

Turn ring **A** upwards or downwards when the outside lights are on to respectively decrease or increase instrument brightness.



fig. 127

HEATED REAR WINDOW (fig. 128)

Press button **A** to switch the heated rear window on/off. The led on the button will come on.

The heated rear window will be automatically switched off after about 20 minutes.

The electrical rearview mirror demister will also be switched on automatically.



fig. 128

FUEL CUT-OFF SWITCH AND CIRCUIT BREAKER

The car is fitted with two safety switches that come into operation in the case of an accident to block fuel supply and power, thereby stopping the engine and the car electric utilities. It also prevents fuel spilling if the lines are broken in the accident or sparks and flashover due to electric component damages.

After the crash, remember to turn the ignition key to **STOP** to prevent the battery running down.



If, after an accident, you can smell petrol or see that the fuel feed system is leaking, do not reset the switches to avoid the risk of fire.

If, after an accident, you cannot see any fuel leaks or damages to the car electric devices (e.g.: headlights) and the car is in a fit state to continue its journey, reset the fuel cut-off switch and the circuit breaker according to the following instructions.

Door unlocking in case of accident

In case of accident with activation of the inertial switch as a consequence, door locks are automatically unlocked to let rescuers reach the passenger compartment from the outside.



Mechanical connections of outside handles are active only if the doors are locked. In case the driver has activated the central door locking from the inside and, after an accident, the inertial switch was not able to activate the automatic door unlocking as a result of battery loss or damage, it will not be possible to reach the passenger compartment from the outside.



Anyway, door opening from the outside depends on their conditions after the accident: if a door is distorted it might be impossible to open it even if it is unlocked. In this case try to open the other car doors.

Resetting the fuel cut-off switch (fig. 129)



Before resetting the fuel cut-off switch, carefully check for any fuel leaks or damages to the car electric devices (e.g.: headlights).

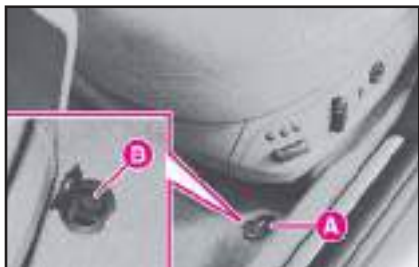

fig. 129

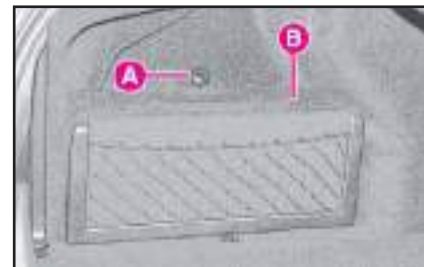

fig. 130

Lift cover **A** set at the driver's left and press button **B** to reset the fuel cut-off switch.

Resetting the circuit breaker



Before resetting the circuit breaker, carefully check for any fuel leaks or damages to the car electric devices (e.g.: headlights).

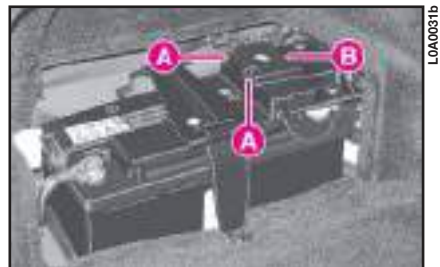

fig. 131

Circuit breaker is located on the left side of the boot, inside a box directly set and connected to the battery positive terminal.

To reach the circuit breaker:

- 1) Open the tailgate.
- 2) Loosen knob **A** (fig. 130) and remove the battery cover **B**.
- 3) Press tabs **A** (fig. 131) and remove cover **B**.
- 4) Press button **A** (fig. 132) to reset the circuit breaker.



fig. 132

Initialising the control units of the door locks, air conditioner and ESP system

After resetting the circuit breaker, to restore correct door locking, air conditioning and ESP system, perform the following operations:

- 1) Close the doors and the tailgate, fit the key into the lock of one of the front doors and perform a door centralised opening/closing cycle.
- 2) Start the engine and turn on the compressor of the conditioner, setting a lower temperature value than that of the environment and check whether the led on the disconnection push button of the conditioner compressor ✱ is lit.
- 3) Turn the steering wheel one fourth turn at least (the car can be at standstill but the engine shall be running) and start running the car for a few metres in a straight line until the ESP warning light (⚠) is off.

ELECTRIC PARKING BRAKE (EPB) (fig. 133)

The car is fitted with the EPB (Electric Parking Brake) that cuts in when switching the engine off and will cut out when starting the engine and pressing the accelerator pedal (for manual gearbox versions when releasing the clutch pedal at the same time). The EPB can also be disengaged manually by pressing button **A** set on the central console with engine running or ignition key to **MAR**.

After disengaging the EPB manually, when opening the driver's door the EPB will re-engage automatically, press button **A** again to disengage it.



fig. 133

The button shape is rather large so the brake can be engaged rapidly, even by the passenger, in case of emergency.

The advantages of this system, compared to the usual lever, are several:

- no effort should be made to engage and disengage the parking brake
- the parking brake efficiency is always at top level in any using condition, contrary to the lever which guarantees the car complete stop only when fully lifted
- the EPB is controlled by electric wires, therefore all problems regarding transmission cables, such as adjustments, freezing or tears, no longer exist
- improved safety as a result of the sophisticated electronic control system, similar to the ABS one, preventing wheels from blocking if the parking brake is engaged during driving
- improved safety when the car is stationary and children are left inside the car; in this case the brake cannot be disengaged if the ignition key is at **STOP** or removed

– it has automatic functions that other systems lack.

When the parking brake is engaged and the ignition key is at **MAR**, the instrument panel warning light (Ⓢ) turns on.

This warning light turns on when the parking brake reaches its highest working level, and it turns off when the brake is disengaged and completely released. Unlike usual parking brakes, whose warning light turns on even when the lever is lifted a little bit, the EPB system warning light turns on only when the car has come to a complete stop.

When the brake is engaged, a typical noise can be heard by the driver; the parking brake is completely engaged or disengaged when the operating noise stops.



When engaging the parking brake keep the brake pedal always depressed.

Automatic engagement

The parking brake is automatically engaged whenever the engine is turned off and afterwards it cannot be disengaged even if button **A** is pressed. Only after turning the ignition key to **MAR** it is possible to disengage the parking brake by pressing the same button.

The EPB will also engage automatically when opening the driver's door with the engine running. In this way the car is completely safe even when the driver leaves it with the engine running (to open the gate, the garage etc.

The operation of the automatic handbrake function procedure when the engine stops or when the driver's side door is open, is disabled when the car is running; should hence the engine be stopped or the driver's side door be opened when the car is not at a full standstill, to operate the handbrake, it is necessary to perform the operation manually.



In order to guarantee the automatic operation of the handbrake, cut off the engine or open the driver's side door only when the car is at a standstill.

Automatic disengagement

If a gear is engaged, the parking brake is released automatically when pressing the accelerator pedal and (for manual transmission versions) releasing the clutch pedal at the same time. The control unit with built-in gradient sensor, will release the brake gradually according to the road slope, thus preventing jumping or unrequired reverse movements.

This is very useful during uphill starting: simply engage the parking brake (if not previously engaged automatically as described before) and press the accelerator pedal (releasing the clutch pedal at the same time, for manual transmission versions) without having to gradually release the lever as required with traditional parking brakes.

IMPORTANT In certain cases, e.g. the car is approaching an obstacle, it could be necessary to disengage the parking brake manually without making use of the automatic function and to brake the car by the service brake, as it is usually done on cars equipped with the traditional parking brake lever.

Deactivating the automatic operation

When it is required to leave the car parked with engine running and parking brake on (e.g. in car wash tunnels), press button **A** after opening the driver's door.

If it is necessary to deactivate the parking brake automatic engagement with the engine off in order to move the car manually (e.g. in the garage or in car wash tunnels), it is possible to deactivate the related function through the **CONNECT** menu. Deactivation of automatic operation must be made with the key at **MAR** and only with the car stationary. Press the **SETUP** key, select "Other setting", deactivate the

“Automatic parking brake” function and the press “OK”. Deactivation of automatic operation can be achieved also in the following way:

- turn the key to **STOP** (the parking brake is engaged)
- turn the key back to **MAR**, depress the brake pedal and at the same time keep button **A** pressed for at least 2 seconds. Warning light  flashes thrice to indicate the automatic operation deactivation.

When the key is turned again to **STOP** the parking brake will not be engaged. The parking brake automatic operation will be automatically restored when the key is turned again to **MAR**.

IMPORTANT If, after the parking brake has been disengaged, the car starts moving at a speed higher than the usual manual movement, deactivation of the automatic mode is immediately cancelled and the parking brake is engaged.



If, after the parking brake has been disengaged, the car starts moving at a speed higher than the usual manual movement, deactivation of the automatic mode is immediately cancelled and the parking brake is engaged.

Use in an emergency

In particular cases (e.g. fault in the whole hydraulic brake system, both service and emergency brake), the parking brake can be used to stop the car running (“dynamic mode”).

Proceed as follows: release the accelerator pedal, press and keep button **A** (**fig. 133**) pressed for the whole manoeuvre: the system electronic control unit will come immediately into action with alternate braking on/off cycles on the rear wheels (thus preventing wheel locking). Braking cycles are applied alternately on right and left wheel to guarantee roadholding, braking continuity and to reduce braking distance.

Wheel locking could take place under the safety speed threshold (lower than 10 km/h).



A buzzer will sound during the whole manoeuvre to indicate that the dynamic mode shall only be used in an emergency, but this is also useful to warn the driver if the parking brake has been inadvertently engaged by other passengers.

Fault indication

The system is controlled by an electronic control unit signalling possible failures by turning on the  warning light on the multifunction display together with the message “EPB FAULT - GO TO DEALER”.

For a higher safety, every time the parking brake button is pressed during a failure, a buzzer will sound to draw the driver’s attention and the  warning light will turn on.

If the parking brake does not reach the required working force (e.g. when the battery is partially flat), the instrument panel warning light  starts flashing.

In case of instrument panel warning light  fault, the  warning light on the multifunction display turns on together with the message “EPB INDICATOR FAULT - GO TO DEALER” to inform the driver about the dangerous situation.



In case of failure indicated by the related warning light and message turning on, drive carefully to a Lancia Dealership because the parking brake might not work.

Emergency disengagement

The electric parking brake is fitted with an independent battery which can be used to disengage the brake, for instance when the car main battery is completely flat or it has broken after an accident.

The additional battery, always kept charged by a dedicated electronic control unit, can engage and disengage the parking brake when it is necessary to push manually the car.

To engage and disengage the electric parking brake when the car main battery is completely flat, turn the key to **MAR** and press the main button on the central console.



fig. 134



fig. 135

The car is fitted also with an emergency button **A** (fig. 134), placed in the boot right compartment, which can be used to unblock the car if it has been stopped on the road for a breakdown or an accident and the key cannot be turned to **MAR** (accident with fire risk). To reach the button remove the compartment cover turning the catch **A** (fig. 135) to **1** with the ignition key.

To disengage the parking brake through the emergency button proceed as follows:

- press and release the main button on the central console
- press and release the emergency button in the boot
- press again and release the main button on the central console.

The time elapsed between these operations should be lower than 30 seconds.

MANUAL GEARBOX

To engage the gears, press down the clutch and put the gear lever into one of the positions shown in the diagram (fig. 136); the diagram is also on the gear lever knob.

To engage reverse (**R**), wait for the car to come to a standstill and lift the ring **A** under the knob (with the fingers of the hand operating the lever).

Release the ring after engaging reverse gear. You do not need to lift the ring to disengage reverse.

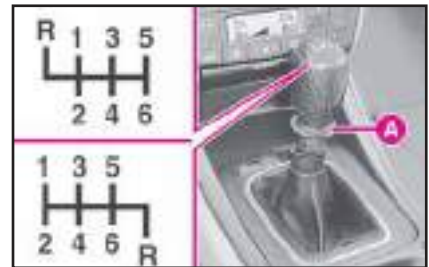

fig. 136



To change gear properly you must push the clutch pedal fully down. It is therefore essential that there is nothing under the pedals: make sure mats are lying flat and do not get in the way of the pedals.



Reverse can only be engaged when the car is at a standstill. Wait for two seconds or longer with the clutch fully pressed before engaging reverse when the engine is running to prevent scraping and damaging the gears.



Do not drive with your hand resting on the gear stick as the force exerted, even if only slight, could lead to premature wearing of the gear-box internal components.

ELECTRONIC AUTOMATIC GEARBOX (COMFORTRONIC)

The electronic automatic gearbox, besides the usual provided operations, enables a manual operation sequential gear selection by shifting the related lever into the special sector.

IMPORTANT In order to use the automatic gearbox in the right way it is necessary to read this paragraph fully, to learn from the very beginning how to perform correct operations, also on the basis of the Shift-lock and Key-lock functions the automatic gearbox is fitted with.

STARTING THE ENGINE

The engine can be started only with the selector to **P** or **N** (fig. 137).

For safety reasons, it is advisable to start the engine with the brake pedal pressed.

IMPORTANT At the moment of departure, after starting the engine, do not press the accelerator pedal before and during the gear lever shift. Observing this precaution is particularly important when the engine is cold.

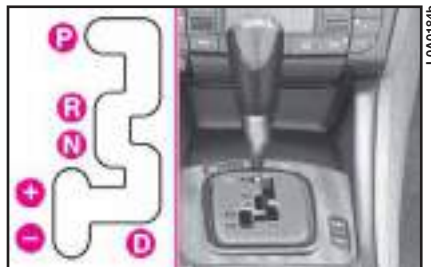

fig. 137

MOVING OFF

After starting the engine at idle and while keeping the brake pedal pressed (Shift-lock safety), shift the gear lever to **D**, or to the manual sequential operation position. Release the brake pedal and press gradually the accelerator pedal.

IMPORTANT The lever shift from **P** is possible only if the ignition key is at **MAR** and the brake pedal is depressed (Shift-lock safety).

The gear lever can be shifted freely from position **D** to other positions without pressing the brake pedal, according to the diagram shown on the mask. Only when shifting from position **P** it is necessary, for safety reasons, to press the brake pedal to move the lever.



Do not tax the engine until it has not reached operating temperature.

The ignition key can be extracted from the ignition switch only when the gear lever is at **P** (Key-lock safety) and the ignition key is at **STOP**. Letter **P** on the instrument panel display (**fig. 138**) will come on for 30 seconds, then it will go off.

IMPORTANT In case of emergency (failures, flat battery, etc.), it is possible to remove the ignition key even if the gear lever is not at **P**. To do this, turn the key to **STOP**, press button **A** (**fig. 139**) and at the same time remove the key.

STOPPING THE CAR

To stop the car press the brake pedal, regardless of the gear lever position.



If the brake pedal is not pressed, when the gear lever is to D or R and the engine is running idle, even on a flat ground, the car starts moving.



fig. 138



fig. 139

SELECTING THE AUTOMATIC/ MANUAL SEQUENTIAL OPERATION

The main characteristic of this gearbox is the possibility to be used in automatic mode or in manual sequential mode.

The operating mode can be selected by setting the gear lever to the right sector at **D** (automatic mode) or to the left sector at **(+/-)** (manual sequential mode).

On display **A** (**fig. 140**) of the instrument panel it is possible to see the engaged gear (**1** to **5** in manual sequential mode) or the symbol **D** (automatic gearbox mode).



fig. 140

AUTOMATIC OPERATION

To activate automatic operation, move the lever to the right sector (**fig. 137**) to one of the following positions:

P - parking (the engine can be started)

R - reverse

N - neutral (engine can be started)

D - automatic forward gear.

IMPORTANT The lever can be shifted from position **P** is possible only with the ignition key at **MAR** and the brake pedal pressed (Shift-lock safety).

The gear lever can be shifted freely from position **D** to other positions without pressing the brake pedal, according to the diagram shown on the mask. Only when shifting from position **P** it is necessary, for safety reasons, to press the brake pedal to move the lever.

P - Parking

When parking the car shift the gear lever to this position. A gearbox device will block the driving wheels.

To avoid accidental engaging, shift from position **P** to any other position is possible only with the brake pedal pressed.

To bring the lever back to position **P** it is not necessary to press the brake pedal, but as a rule it is suggested to keep the brake pedal pressed even in this case.

IMPORTANT Shift the lever to **P** only when the car is stationary.



Before leaving the car, check that the electric parking brake (EPB) is on. Shift the lever to position **P** even when the car is left with the engine running.

In case of emergency (failures, flat battery, etc.), it is possible to shift the lever from position **P** to **N**, **D** or **R** by pressing lever **A** (fig. 141) set under the gear lever mask. To reach the lever, remove the press-fit oddment compartment shelf **B** in front of the gearshift lever.

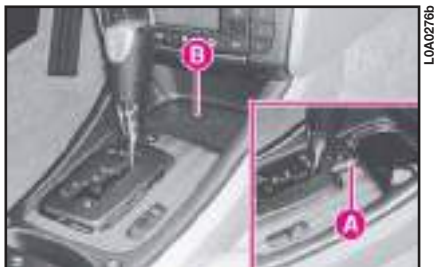

fig. 141

R - Reverse

Shift the lever to **R** with the car stationary, the engine running idle and the brake pedal pressed.

When the lever is at **R** backup lights turn on and a buzzer will sound for about 4 seconds to warn other people that reversing is in progress.

IMPORTANT Even with the lever in position **R**, the reverse gear cannot be engaged if the car speed is higher than the established value. When the speed is reduced, the reverse gear can be engaged and it remains engaged even if the car speed overcomes that limit.

N - Neutral

This is the position to be used when the car must be pushed or towed.

D - Forward gear (automatic)

This is the position to be used when all automatic gearbox functions are required.

The electronic control unit controls that the five gears are engaged automatically according to car speed, engine rpm, accelerator pedal position and pressing speed, together with the main driving conditions such as hills, slopes, curves and braking.

Indeed, the electronic automatic gearbox is able to choose, according to the type of driving adopted by the driver, different programmes subdivided into comfortable driving, economy driving and sporty driving, with shift points ranging between low and high.

If the accelerator pedal is pressed rapidly, the gearbox selects the sporty driving programme to meet the request for a higher car performance. To disengage this function, release the accelerator gradually.

If the accelerator pedal is pressed more slowly, the economy programme is automatically selected.

The electronic control unit is able to recognize particular situations like a curve, detected as a different speed of front wheel instant rotation through the ABS active sensors, thus preventing shifting to the higher gear until the engine revolution limit is reached. Only with this condition or at the end of the curve will it be possible to shift gear. This strategy is useful to improve the car balance and to guarantee a prompt acceleration when coming out of the curve, since the car has already the right gear engaged.

Likely, during sudden braking, the lower gear is engaged to exploit the engine braking action at best. In case of a curve, the new gear will be engaged during slowing down before the curve, therefore when coming out of the curve it will not be necessary to shift gear to accelerate.

Sporty driving on mixed roads is recognized by the control unit because the accelerator pedal is released rapidly; if this condition is detected, the gear selected is maintained even if the accelerator has been released, without shifting to higher gears, in order to increase the engine efficiency for the following acceleration.

The gear electronic control unit is able to recognize hills as a result of the torque signals coming from the engine on the basis of the car speed, therefore it is able to eliminate useless gear shifts when the accelerator is released (e.g. before cornering) and to use only those gears required to improve the driving comfort.

Likely, the control unit is able to recognize slopes and to prevent shifting to higher gears when the accelerator is released, in order to use the “exhaust brake” at best to the advantage of the braking system and the car control.

IMPORTANT The “exhaust brake” function and shifting to a lower gear during braking is not activated when the ABS is operating.

A longer gear (5th) can be used when the car is driving for long distances with constant high speed, but limited engine rpm, thus reducing driving noise and fuel consumption. That is why, when a higher car per-

formance is requested in terms of acceleration and maximum speed, this gear is almost never selected.

The electronic automatic gearbox is fitted with a device reducing inside gearing dragging when the car is stationary and the brake pedal depressed. The advantages of such a function are a considerable noise reduction, with consequent vibration reduction and limited fuel consumption.



When the engine is running idle and the lever is at D, the car starts moving even if on a flat ground: keep the brake pedal pressed until moving off.

Winter programme

When starting to drive with a reduced road grip (snow-covered, icy road, etc.), the shift control unit automatically engage the “ICE” programme.

This programme allows starting with the 2nd gear engaged, in order to improve the gear shift efficiency according to grip conditions.

“ICE” programme activation is possible only when the gear lever is at **D**. If the lever is in the sequential gear sector, the gear engaged at the moment of moving off is always that selected by the driver.

When the “ICE” programme has been activated, Kickdown is not operating.

Kick down

When maximum acceleration is required (e.g. during overtaking), if the accelerator is rapidly and fully depressed, lower gears are automatically engaged, provided the engine rpm enable this operation.

Later, when the accelerator pedal is released, the gear engaged is selected according to the type of driving and the position of the accelerator.

Kick-down can be engaged only when the gear lever is at **D**.

IMPORTANT It is suggested to use Kick-down only when required, e.g. during overtaking, to limit the fuel consumption.

MANUAL SEQUENTIAL OPERATION

To use the manual sequential operation move the lever to the two-position left sector (**fig. 137**):

(+) = higher gear

(-) = lower gear.

Shifting to the manual sequential sector is possible only from position **D**: the gear automatically selected when the lever is moved will remain engaged.

It is possible to pass to the gear manual sequential control in any driving condition.

To engage a higher gear, move the lever to (+) and to shift a lower gear move the lever to (-).

IMPORTANT If gear shift generates a runaway speed rate, such gear is cancelled by the electronic control unit and the driver is warned by a buzzer and by the engaged gear flashing on the instrument panel display.



When the manual sequential operation is set, gears shall be shifted manually, as for versions with the traditional manual gearbox. Only when the car stops the gear automatically engaged is the first one.

If the lever is brought back to **D** the gearbox immediately starts to work automatically and will be engaged according to the type of driving selected.

IMPORTANT The electronic control unit is programmed to shift one gear at a time, therefore rapid and repeated actions do not correspond to rapid and repeated gear engaging. A higher or lower gear is engaged by shifting the lever to position (+) or (-) after the previous request has been realized.

In case of failure of the manual sequential system, the electronic control unit will select the automatic operation.

FAILURE INDICATION

Automatic gearbox faults are indicated by multifunction display warning light  coming on with the following messages:

- AUTOMATIC TRANSMISSION OIL TEMP. HIGH
- AUTOMATIC TRANSMISSION FAULT.

Automatic transmission oil temperature high

This message is displayed when the gearbox oil has reached the maximum preset temperature. In this case the electronic control unit has an emergency programme.

Anyway, it is suggested to stop the car, to set the lever to **P** or **N** and to keep the engine running idle until the message displayed disappears. Then start driving again without taxing the engine.

If the message is displayed again, re-stop the car and let the engine run idle until the message disappears.

If the interval between the first and second message appearance is lower than 15 minutes, stop the car, stop the engine and wait until the engine-gearbox unit is completely cold.

Automatic transmission fault

If this message is displayed during driving, it means that there is a failure in the automatic gearbox. In this case the electronic control unit has an emergency programme.

In such conditions, stop the car and stop the engine for at least 1 minute. When the engine is restarted, the self-diagnosis system could exclude that failure, that however will be stored by the electronic control unit.

Even in fault conditions it is possible to move the lever to **R**, **N** and **D**. If the lever is in position **D**, the control unit of the automatic gearbox will select only certain gears, according to the type of failure detected.



In case of failure of the automatic gearbox, take the car immediately to a Lancia Dealership to have the failure eliminated.

If the failure is signalled when the engine is started, it means that the electronic control unit had stored it previously, before stopping the engine. Even in this case, go to a **Lancia Dealership** to have the automatic gearbox checked.



When driving with automatic gearbox faulty, drive carefully considering the limited car efficiency in terms of acceleration and speed. In addition, when driving with automatic gearbox faulty, the reverse block might not be operating: for this reason it is absolutely necessary to move the lever to position R while the car is moving.

SOUND SIGNAL

A buzzer will sound in the following conditions:

- for about 15 seconds when the driver's door is opened while the engine is running or not and the gear lever has a position different from **P**
- for about 15 seconds when the engine is turned off and the gear lever has a position different from **P**
- for about 4 seconds when the gear lever is shifted to **R** (reverse)
- with the manual sequential operation on, when the selected gear is not accepted by the electronic control unit (e.g. since it might generate a runaway speed rate).

BUMP STARTING

Never bump starting the engine (by pushing, towing, etc.). In an emergency, when the battery is flat, start the engine with the appropriate emergency battery according to the instructions contained in chapter "In an emergency".

TOWING THE CAR

IMPORTANT To tow the car observe local current laws and follow the instructions contained in chapter “In an emergency”.

If the car must be towed, observe the following precautions:

- if possible, transfer the car on a towtruck
- otherwise, tow the car by raising the front driving wheels
- even if the latter solution is not possible, the car can be towed for less than 50 Km at a speed of 50 km/h.

Towing shall be performed with gear lever to N.



Before starting towing, disengage the parking brake as described in the relevant paragraph and leave the Keyless System CID (if any) in the passenger’s compartment to prevent automatic steering lock. **Do not tow the car with the engine running.**



If these rules are not respected, the automatic gearbox might be severely damaged.

The car can be towed only for short distances and at a low speed: if it is necessary to tow it for a longer distance, raise the driving wheels so that the gearbox is not dragged during towing.

ESP AND ASR SYSTEMS

ESP SYSTEM (ELECTRONIC STABILITY PROGRAM): GENERAL

ESP is an electronic system controlling the car stability which affects the driving torque and brakes the wheels in a different way in case of grip loss, thus making the car recover the right driving direction.

During driving the car is subject to side and longitudinal forces which can be controlled by the driver until tire grip is acceptable. When the latter is lower than the minimum level, the car starts skidding.

If the road bed is uneven (bumpy road, presence of ice, mould, etc.) tyre grip is considerably reduced. In these conditions, when extreme manoeuvres are made, the car might start skidding.

If the sensors detect the conditions which might cause car skidding, the ESP system affects the engine and the brakes by generating a torque which makes the car recover the right driving direction.



The system operations, in terms of safety, should not make the driver run useless risks. The driving behaviour must always be appropriate, according to the conditions of the road bed, visibility and traffic. Anyway, the driver is held responsible for a safe driving. The ESP system helps the driver control the car in case of tyre grip loss, however the forces used by the system to control the car stability still depend on the grip ratio between tyres and road bed.

ESP SYSTEM OPERATION

ESP is automatically started when the car is started and it cannot be disengaged. On the contrary, it is possible to exclude the ASR system by pressing the related button on the central console.

The ESP main components are the following:

- an electric-hydraulic control unit processing signals coming from the various sensors and choosing the most appropriate strategy by operating solenoid valves and the engine control unit;
- a sensor detecting the steering wheel rotation angle;
- 4 sensors detecting the rotation speed of each wheel;
- a sensor detecting the car rotation around a vertical axis;
- a sensor detecting side acceleration (centrifugal force).

The ESP core is a sensor, of aeronautic origin, detecting the car rotations around its vertical axis. Centrifugal forces generated when the car is cornering are detected by a high-sensitive side acceleration sensor.

The ESP stabilizing action is based on the signals coming from the steering wheel rotation sensors, from the side acceleration sensors and the wheel speed sensors, thus recognizing the driving direction selected by the driver when turning the steering wheel.

The control unit processes each information coming from the sensors and is able to recognize every single moment of the car position and to compare it with the direction the driver is willing to follow. In case of discrepancy, the control unit instantly selects and controls the most appropriate actions to make the car recover the required direction: it brakes with a different intensity one or more wheels and, if necessary, reduces the power supplied by the engine. Corrections are con-

stantly changed and controlled in the attempt to keep the driver's direction.

The ESP system considerably increases the car safety in several critical conditions and it is particularly useful during overtaking, when the grip conditions on the road bed change.



To make ESP, ASR and ABS systems work properly, the tyres must absolutely be of the same brand and type on all wheels, in perfect conditions and, above all, of type, brand and size specified.

ASR FUNCTION (ANTISLIP REGULATION)

General

The ASR function is part of the ESP system and it checks the car drive, taking action every time one or both driving wheels slip, thus preventing car instability and tyre wear.

On the basis of slipping conditions, two different check systems are activated:

- if slipping affects both driving wheels, as a result of the excessive force transmitted, the ASR function reduces the power supplied by the engine;
- if slipping affects only one of the driving wheels, the ASR function automatically brakes the slipping wheel, with an effect similar to the self-locking differential.

The action of the ASR function is particularly useful in the following conditions:

- internal wheel slipping when cornering due to load dynamic variations and excessive acceleration;
- excessive power supplied to wheels according to the road bed;
- acceleration on slippery ground, covered with snow or ice;
- in case of grip loss on wet ground (aquaplaning).

ASR function activation

The ASR function is activated automatically whenever the engine is started.

During driving it is possible to disengage and engage this function by pressing button A (fig. 142) on the central console.

When the ASR function is on, symbol  is lighted on the multifunction display together with the message "ASR ON".

When the ASR function is off, symbol  is lighted on the multifunction display together with the message “ASR OFF”.

The function deactivation is indicated by switching on of the related warning light **B** on the button. If this function is deactivated during driving, it will be reactivated automatically at the following start up.

IMPORTANT During driving on a snow-covered ground, with snow chains on, it might be useful to deactivate the ASR function: in these conditions driving wheel slipping at start up is useful to reach higher drive.



fig. 142

MSR SYSTEM (ENGINE DRIVE ADJUSTMENT)

The car is fitted with a system, part of ASR, affecting the engine torque in case of sudden gear shift, thus preventing excessive driving wheel dragging which, in extremely low grip conditions, can make the car loose stability.

ESP SYSTEM ACTION

The ESP action is indicated by flashing of warning light  on the instrument panel, to inform the driver that the car is in critical stability and grip conditions.

ESP AND ASR FAILURE INDICATION

In case of failure, ESP and ASR systems are automatically deactivated and symbol  and message “ESP FAULT” will come on with fixed light on the multifunction display together with warning light **B** on the ASR button.

If the failure affects only the ESP system, symbol  and message

“ESP FAULT” are lighted on the multifunction display, while the warning light on button **B** is off and the ASR system remains operating.

If the failure affects only the ESP system, symbol  and message “ESP FAULT” are lighted on the multifunction display, while the warning light on button **B** is off and the ASR system remains operating.

In case of ESP or ASR failure, the car behaves in the same way as a car that is not fitted with this system: in any case it is advisable to contact a **Lancia Dealership** as soon as possible.

The following table summarizes warning light indications according to the different operating conditions.

| Operating or failure conditions | | System condition | ASR button warning light | ESP warning light on instrument panel |
|--|------------------|--------------------------|--------------------------|---------------------------------------|
| Engine start up (key turned to MAR) | | Warning light check | On for about 3 seconds | On for about 4 seconds |
| Driving in normal conditions | ASR on | ASR on ESP on | Off | Off |
| | ASR off manually | ASR off ESP on | On | Off |
| Driving in conditions which might lead to slipping | ASR on | ASR active ESP active | Off | Flashing |
| | ASR off manually | ASR off ESP active | On | Flashing |
| ASR fault | | ASR and ESP off | On | On |
| ESP fault | | ASR on ESP off | Off | On |

INITIALISING THE ESP SYSTEM CONTROL UNIT

Whenever the battery is electrically connected again or it is reloaded after being completely flat or after replacing one of the protection fuses, to restore the correct operation of the ESP system, of the door locking, and of the air conditioning, it is necessary to perform the initialisation operations contained in the paragraph “If battery is to be disconnected” in the chapter “In an emergency”.

CRUISE CONTROL (CONSTANT SPEED REGULATOR)

GENERAL

The electronic cruise control allows to drive your car at the required speed without pressing the accelerator pedal. This reduces fatigue when driving on motorways, especially during long journeys, because the set speed is automatically maintained.

IMPORTANT The device can only be set to speeds exceeding 30 km/h (40 to 180 km/h for 2.4 JTD 20V CAE version).



The cruise control must only be used when the road and traffic conditions allow to keep a constant speed in total safety for an adequately long time.

The device is automatically switched off when:

- the brake pedal is pressed
- the clutch pedal is pressed
- the gear lever is unintentionally shifted to N.



In versions with automatic transmission, never shift the lever to N when the car is running.

CONTROLS (fig. 143)

The cruise control is operated by means of switch **A**, ring **B** and button **C** (RCL).

Switch **A** has two positions:

- **OFF** in this position, the device is off
- **ON** this is the normal device operating position. When the device is ON, symbol  lights up on the multifunction display, together with message “CRUISE CONTROL ON”.

Ring **B** is used to set and maintain the car speed or to increase or decrease the set speed.



fig. 143

Turn ring **B** to position (+) to set the speed reached or to increase the stored speed.

Turn ring **B** to position (-) to decrease the stored speed.

The speed will be increased or decreased by approximately 1 km/h each time ring **B** is operated. Hold the ring turned to set the speed continuously. The new set speed will be automatically kept.

Button **C (RCL)** allows to reset the stored speed.

IMPORTANT Turn the ignition key to **STOP** or switch **A** to **OFF** to delete the stored speed and switch the system off.

Storing the speed

Move switch **A** to **ON** and take the car to the required speed normally. Turn ring **B** to (+) for at least three seconds and release it. The car speed will be stored and you can now release your foot from the accelerator.

The car will continue at the constant speed until one of the following events occur:

- the brake pedal is pressed
- the clutch pedal is pressed
- the automatic gear lever is unintentionally shifted to **N**.

IMPORTANT If required (e.g. for overtaking) you can accelerate simply by pressing the accelerator. The car will return to the previously set speed when the accelerator pedal is released.

Resetting the stored speed

To reset the stored speed after switching the device off, e.g. by pressing the brake or the clutch pedals:

- accelerate progressively to reach a speed which is close to the previously set speed
- engage the gear which was engaged when the speed was set (4th, 5th or 6th gear)
- press button **C (RCL)**.

Increasing the stored speed

The stored speed can be increased in two ways:

- by pressing the accelerator pedal and storing the new speed (turning ring **B** for longer than three seconds)

or

– by momentarily turning ring **B** to (+): each turn of the ring will correspond to a small speed increase (approximately 1 km/h), while a continuous pressure will correspond to a continuous speed increase. Release ring **B**: the new speed will automatically be stored.

Reducing the stored speed

The stored speed can be decreased in two ways:

– by switching the device off (e.g. by pressing the brake pedal) and then storing the new speed (turning ring **B** to (+) for longer than three seconds)

or

– by turning ring **B** to (–) until the new speed is reached. The new speed will automatically be stored.

Deleting the stored speed

The stored speed is automatically deleted when:

- the engine is stopped
- or
- switch **A** is turned to OFF.



When driving with the cruise control, do not shift the gear lever to neutral. You should only switch the cruise control on when the traffic and road conditions allow this in complete safety, i.e. straight and dry roads, motorways, fast moving traffic and smooth road surface. Do not use the device in cities or in heavy traffic.



The cruise control can be switched on at speeds higher than 30 km/h (40 to 180 km/h for 2.4 JTD 20V CAE version). The device can only be switched on in 4th, 5th or 6th gear, according to car speed. In versions with automatic transmission, the device must only be switched on with the gear lever at D during automatic operation without shifting the lever subsequently, or with the 3rd or 4th gear engaged during manual sequential operation.

When travelling down-hill the speed may increase with respect to the stored value according to the change in engine load.

RADAR CRUISE CONTROL (RCC) (where provided)

GENERAL

The Radar Cruise Control (RCC) assists the driver by monitoring both the cruise speed and the distance of the vehicle ahead along the running path: it allows to drive your car at the required speed, without pressing the accelerator pedal.

The system reduces fatigue when driving on motorways, especially during long journeys, since the stored speed is maintained automatically; moreover, the system contributes to keeping a safe distance from the vehicle ahead. Constant speed driving also allows to cut down fuel consumption and makes traffic smoother.

The system is electronically controlled, self-contained and, therefore, does not require communication with other vehicles or the presence of similar systems on the other vehicles.



The Radar Cruise Control is not an “automatic pilot” but a driver-assisting device; therefore, only the driver is responsible for his/her driving behaviour and must comply with the highway code regulations in force, as well as with any other provision concerning road traffic.



This system detects just moving vehicles and ignores whatever immobile object.



The Radar Cruise Control is not an anti-collision device: it cannot detect the presence of obstacles on the road or stop the car in case of danger. Any action performed by the driver on the brake or accelerator pedals takes priority over the cruise control system; for this reason, the responsibility for road safety always rests with the driver.



The system cannot actuate emergency braking: the maximum deceleration automatically performed by the system is limited compared to the actual braking power of the brake system; therefore, emergency braking can and must be performed only by the driver.

IMPORTANT The system can only be switched on when the car speed ranges from 30 to 160 km/h and is automatically switched off by pressing the brake pedal. If the car speed falls below 30 km/h when the system is on, a buzzer and a visual indication warn the driver to take control of car speed again. When the car speed exceeds 160 km/h after a slight acceleration (“override” mode), a buzzer and a visual indication will warn the driver that the system is off.

IMPORTANT The Radar Cruise Control cannot be activated when the driver has switched the ASR system off.



As long as the car speed exceeds 160 km/h, one of the following indications will warn the driver that the

max. speed limit controlled by the system is exceeded.



If the road in front of car fitted with Radar Cruise Control is free.



If a vehicle is detected in front of the car fitted with Radar Cruise Control.



The Radar Cruise Control must only be used when the road and traffic conditions allow to keep a constant speed in total safety for an adequately long time.

CONTROLS (fig. 144)

The Radar Cruise Control is operated by three controls, as well as by the accelerator (to increase speed) and the brake pedal (to switch the system off).

Controls are as follows:

- ring **A** to switch the system on/off and to set the distance from the vehicle ahead, depending on its speed
- ring **B** to increase/decrease the set speed
- button **C** to restore the stored speed.



fig. 144

Ring **A** has four positions:

OFF: system off

 greatest distance from the vehicle ahead

 intermediate distance from the vehicle ahead

 shortest distance from the vehicle ahead.

The distance between the two vehicles is gradually increased as the speed is increased, set levels being equal.

IMPORTANT Turn the ignition key to **STOP** or ring **A** to **OFF**, to delete the stored speed and switch the system off. To restore system operation, turn the ring **A** to **OFF** and repeat the setting operations.

When the system is on, that is, ring **A** is in any position other than **OFF**, symbol  lights up on the multi-function display, together with message “RADAR CRUISE CONTROL ON”. The warning light will remain on until the system is switched off by turning ring **A** to **OFF**.



Ring **B** is used to store the car speed and keep it constant, or to increase or decrease the stored speed.

Turn ring **B** to (+) to store the speed reached or increase the stored speed.

Turn ring **B** to (-) to decrease the stored speed. Slowing down can also be obtained, when required, by braking system automatic operation.

Every time ring **B** is turned, the speed is increased or decreased by about 1 km/h. By keeping the ring rotated, the stored speed will change continuously at intervals of 10 km/h. The new speed reached will be maintained automatically.

When ring **B** is turned, the car's actual speed is considered as reference speed (cruise speed). This speed can automatically decrease depending on traffic conditions, and the system can shift from the speed control condition to the distance control condition. The driver is informed of the system's operating condition by the instrument panel display.

Button **C** (**RCL**) allows to reset the stored speed. In fact, when driving the car with the system on, the driver can switch the system off by simply braking. In this case, the cruise speed previously set is kept in the memory and can be enabled again at any time by pressing button **RCL**.

Storing the speed

Move ring **A** to any position other than **OFF** and take the car to the required speed.

Turn ring **B** to (+), then release it. The car speed will be stored and shown on the instrument panel display; now, the accelerator pedal can be released.

The car will continue at the constant speed until one of the following events occur:

- the brake pedal is pressed
- presence of a vehicle running ahead more slowly along the running path, in the same running direction.

IMPORTANT If required (e.g. for overtaking) you can accelerate simply by pressing the accelerator. The car will return to the previously set speed when the accelerator pedal is released. If 160 km/h speed is exceeded, restore the stored speed by pressing **C** (**RCL**).

Resetting the stored speed

If the system has been switched off by pressing the brake pedal, the stored speed can be resumed by pressing button **C** (**RCL**).

Increasing the stored speed

The stored speed can be increased in two ways:

- by pressing the accelerator and storing the new speed (turning ring **B** to (+))

or

- by temporarily turning ring **B** to (+): each turn of the ring will correspond to a 10 km/h speed increase, while a continuous pressure will correspond to a continuous speed increase at intervals of 10 km/h. Release ring **B**: the new speed will automatically be stored.

The new set speed will be shown on the display in place of the previous one.

Reducing the stored speed

The stored speed can be decreased in two ways:

- by switching the device off (e.g. by pressing the brake pedal) and then storing the new speed (turning ring **B** to (+))

or

- by turning ring **B** to (-) until the new speed is reached. The new speed will automatically be stored.

The new set speed will be shown on the display in place of the previous one.

Deleting the stored speed

The stored speed is automatically deleted when:

- the engine is stopped
- ring A is turned to **OFF**.

When the system is switched off, any information shown on the instrument panel display will be deleted.

Maintaining speed and distance

The system will maintain the stored speed when no vehicle is detected along the running path. If, on the contrary, a vehicle is detected which runs at a low speed, the system will automatically perform the operations (acceleration, deceleration or slight braking) required to keep the set distance from the vehicle ahead.



The maximum deceleration performed by the system automatically is limited compared to the actual braking power of the brake system; therefore, emergency braking can and must be performed only by the driver. A buzzer will warn the driver that the brakes shall be applied.

Pressing the brake pedal will switch the system off, whereas it will always be possible to accelerate, (e.g for overtaking), without switching the system off; the system will automatically bring the car back to the stored speed when the accelerator pedal is released (provided that 160 km/h speed has not been exceeded).

The multifunction display gives to the driver concise information on the stored speed, the presence of a running vehicle (if any) and the set distance.

Detecting a vehicle with the system active but not switched on

When the system is active (ring A set to any position other than **OFF**), it can detect the presence of a vehicle only after it has been switched on at least once (by turning ring B to (+)).

Subsequently, the presence of a running vehicle will always be indicated, even when the system is off, until deactivating the system (ring A set to **OFF**).

Detecting a vehicle with the system switched on

When the system is switched on by turning ring **B** to (+), any vehicle running in front of the car (within 130 metres) and along the running path will be signalled to the driver on the instrument panel display, with the following icon:



set distance 



set distance 



set distance 

This icons indicate the engagement of speed and distance control with detection of a running vehicle along the running path, “picked” by the system. The three different icons indicate the three distance levels the driver can select.

When the external temperature is less than 3 °C, the system will automatically be set to maintain a greater distance from the vehicle ahead, regardless of the distance set.

If the system is temporarily switched off by pressing the accelerator pedal, the stored speed will flash on the instrument panel and the distance control icon will disappear (if shown on the instrument panel display). The

icon (if any) indicating the vehicle detected on the traffic lane will, on the contrary, remain visible.



With system active and car speed exceeding 80 km/h, switching the left direction indicators on to signal overtaking will cause the distance from the vehicle ahead (already “picked”) to be automatically decreased in order to facilitate the manoeuvre. If the driver does not overtake within a few seconds, the car will return to the set distance.

If the Radar Cruise Control is active and the braking power enabled for the function does not ensure the maintenance of the set distance from the vehicle ahead, a sound and visual signal (together with message “BRAKE SAFETY” shown on the

multifunction display) warn the driver and invite him to resume speed control.



IMPORTANT If the Radar Cruise Control is active and the speed of the vehicle ahead falls below 30 km/h, a sound signal with message “RADAR CRUISE CONTROL NOT ACTIVATED” on the multifunction display warn the driver to resume speed control



Therefore, the Radar Cruise Control does not ensure control when you are driving in a queue; the driver must therefore halt the car and start it off after stopping in a queue, and he must also switch on the speed control function every time

IMPORTANT NOTES CONCERNING THE RADAR CRUISE CONTROL

When driving with the Radar Cruise Control on, its regular operation could be affected by certain situations.

The system operation could be influenced in the following cases:

If the vehicle picked by the car fitted with Radar Cruise Control leaves the radar sensor detection range, the system could no longer be able to detect it and therefore it will speed up the car or pick another vehicle running ahead (**fig. 145**).

If a vehicle enters the area between the car fitted with Radar Cruise Control and the picked vehicle (**fig. 146**), the system could not be able to control braking and it will therefore warn the driver to take control of the car.

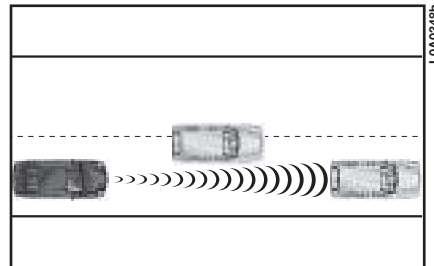

fig. 145

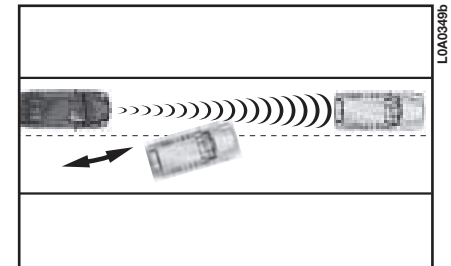

fig. 146

If a vehicle enters the same running path as that of the car fitted with Radar Cruise Control and sets too close to it (**fig. 147**), the system could not be able to detect it.

If two heavy-duty vehicles (e.g.: trucks) overtake at low speed (**fig. 148**), the car fitted with Radar Cruise Control could temporarily detect the road as free.

When entering or leaving a curve (**fig. 149**), a vehicle running ahead could temporarily get out of the radar detection range, or another vehicle running in the adjacent lane could be detected.

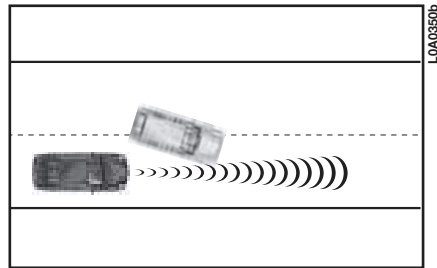

fig. 147

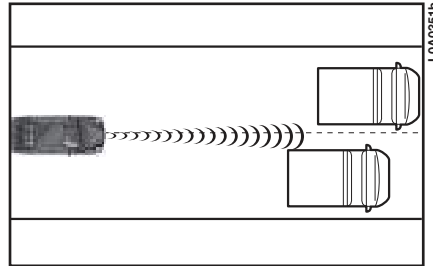

fig. 148

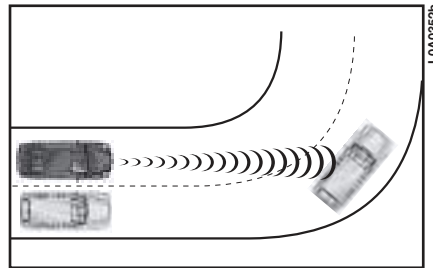

fig. 149

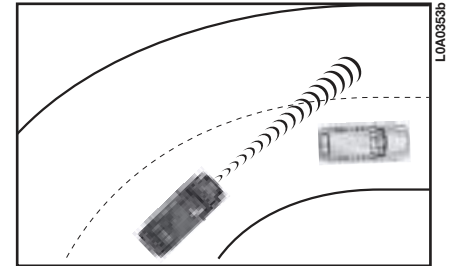

fig. 150

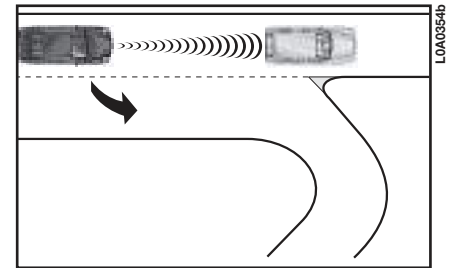

fig. 151

At a slip-road (**fig. 151-152**), if following a vehicle running at a speed lower than that set on the car fitted with Radar Cruise Control, when changing lane the path will result free and therefore the system will accelerate to restore the set speed.

When reaching a steep cat's back (fig. 153), the picked vehicle could get out of the radar detection range (thus missing "picking").

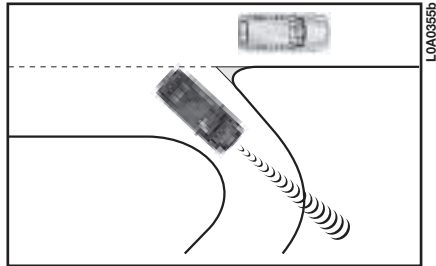

fig. 152

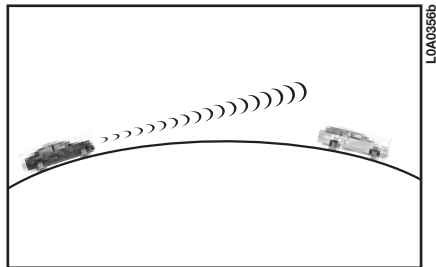

fig. 153



The Radar Cruise Control features proper strategies to keep adequate comfort level when travelling on a road with curves, e.g.: reducing the cruising speed if required. The Radar Cruise Control however cannot detect the road turn; the driver is therefore the only responsible for adjusting the car speed to curves, slip-road or sharp-curves, not necessarily on highway sections.



Whenever the picked vehicle gets out of the radar detection range, the car will accelerate to return to the set cruising speed.

FAULT INDICATION

System anomalies are signalled by the lighting of symbol  on the multifunction display, together with message "RADAR CRUISE CONTROL FAULT". The fault indication remains on even when system ring A is turned to **OFF**.



Whatever the system's fault, the Radar Cruise Control is fully switched off.

The driver will be warned by a special display message when the system is deactivated because the lens is dirty.



fig. 154

In this case, clean the sensor protection lens, shown in **fig. 150** with a wet cloth; do not use dry, rough or hard cloths. Should the dirty lens message stay on after cleaning, contact a **Lancia Dealership**.



If the Radar Cruise Control went off due to excessive lens dirt, when restarting the car a few km shall be covered before switching the system on again in order to let the system check if previous conditions (causing Radar Cruise Control turn off) have been removed.



The sensor is built into the front bumper: impacts can therefore damage it.

IMPORTANT Failure to one of the safety systems connected to the Radar Cruise Control (ABS or ESP system) will cause Radar Cruise Control failure indication.



The Radar Cruise Control should be switched on only when road and traffic conditions allow the driver to drive safely, that is, when the road is straight and the surface is not slippery, when the car is driven on a freeway or motorway, and when traffic flows smoothly. Do not use the device when driving in urban areas or when traffic is heavy.



Do not use the Radar Cruise Control under poor visibility conditions (e.g.: fog, heavy rain, snow, etc.), since the system performance could be badly affected.

IMPORTANT As you approach a bend, it may be necessary to reduce the stored speed or switch the system off by pressing the brake pedal.



The brake pedal is operated by the Radar Cruise Control system: do not position your foot under the brake pedal.

IMPORTANT The Radar Cruise Control can only be switched on when the car speed ranges from 30 and 160 km/h. The Radar Cruise Control is automatically switched off when any of the ABS, ASR, MSR and ESP systems comes into operation. Moreover, it is switched off when engaging reverse gear, neutral or the electronic parking brake (EPB).

IMPORTANT The Radar Cruise Control cannot be activated when the driver has switched the ASR system off.



In the device is faulty or does not work, turn ring A to OFF and contact a Lancia Dealership

IMPORTANT Ring A can be constantly left in a position other than **OFF** without damaging the Radar Cruise Control. The device should however be switched off when not in use by turning ring A to **OFF** to prevent storing speeds accidentally.

PARKING SENSOR

The parking sensor provides distance information to the driver when the car moves near obstacles placed in front of and behind it.

The information on the presence and distance of obstacles is sent to the driver by means of sound signals, the frequency of which depends on the obstacle distance.

By integrating the direct visual information with the sound signal emitted by the system, the driver can therefore avoid possible collisions.



fig. 155



The responsibility for parking manoeuvres and other dangerous manoeuvres always rests with the driver. When performing such manoeuvres, always make sure that no persons or animals stand in the area where the car is to be parked. The parking assist system should be considered as an aid to the driver; in any case, greatest attention must be paid when performing dangerous manoeuvres, even at low speed.

The system front and rear sensors are activated automatically when engaging reverse with the ignition key at **MAR**. Disengaging the reverse gear will turn the rear sensors off; front sensors will stay on until 15 km/h speed is exceeded to allow concluding the parking manoeuvre.

Front sensors can be switched on by pressing button **A** (fig. 155) placed on the central console in front of the gear lever; when the front sensors are on, warning light **B** lights up on the button. To switch the sensors off, press button **A** again.

When the sensors are on, the system starts sending out sound signals from the front or rear buzzers as soon as an obstacle is detected; the signal frequency increases as the obstacle gets nearer. When the obstacle is at a distance of less than 30 cm, a continuous sound is emitted. Depending on the position of the obstacle (in front or behind), the sound will be emitted from the corresponding buzzer (front or rear). The sound signal will immediately stop if the distance from the obstacles increases. The tone cycle remains the same if the distance measured by the central sensors does not change; however, if this condition occurs with side sensors, the signal will be interrupted after about 3 seconds, to avoid, for instance, sending out signals in case of parking manoeuvres along walls.

SENSORS

The system detecting the distance from obstacles uses 4 sensors housed in the front bumper (fig. 156) and 4 sensors housed in the rear bumper (fig. 157).



fig. 156



fig. 157



To ensure proper operation of the parking assist system, it is essential that the sensors placed on bumpers are always free from mud, dirt, snow or ice.



When cleaning the sensors, take the greatest care not to scratch or damage them; to this regard, do not use dry, rough or hard cloths. Sensors must be washed with clean water, to which car shampoo can be added, if necessary. In car-wash stations that use high-pressure or steam-jet hydraulic cleaning machines, clean the sensors fast by keeping the nozzle at a distance of at least 10 cm.



When the bumper needs re-painting or the sensor area needs touching-up with paint, contact a Lancia Dealership only. Incorrect application of paint could adversely affect the parking sensor operation.

Sensor operating range

The sensors allow the system to monitor the car's front and rear parts.

Their position covers the middle and side areas of the car's front and back (fig. 158).

Obstacles placed in the middle area are detected at a distance of less than approx. 0.9 m (front) and 1.50 m (rear).

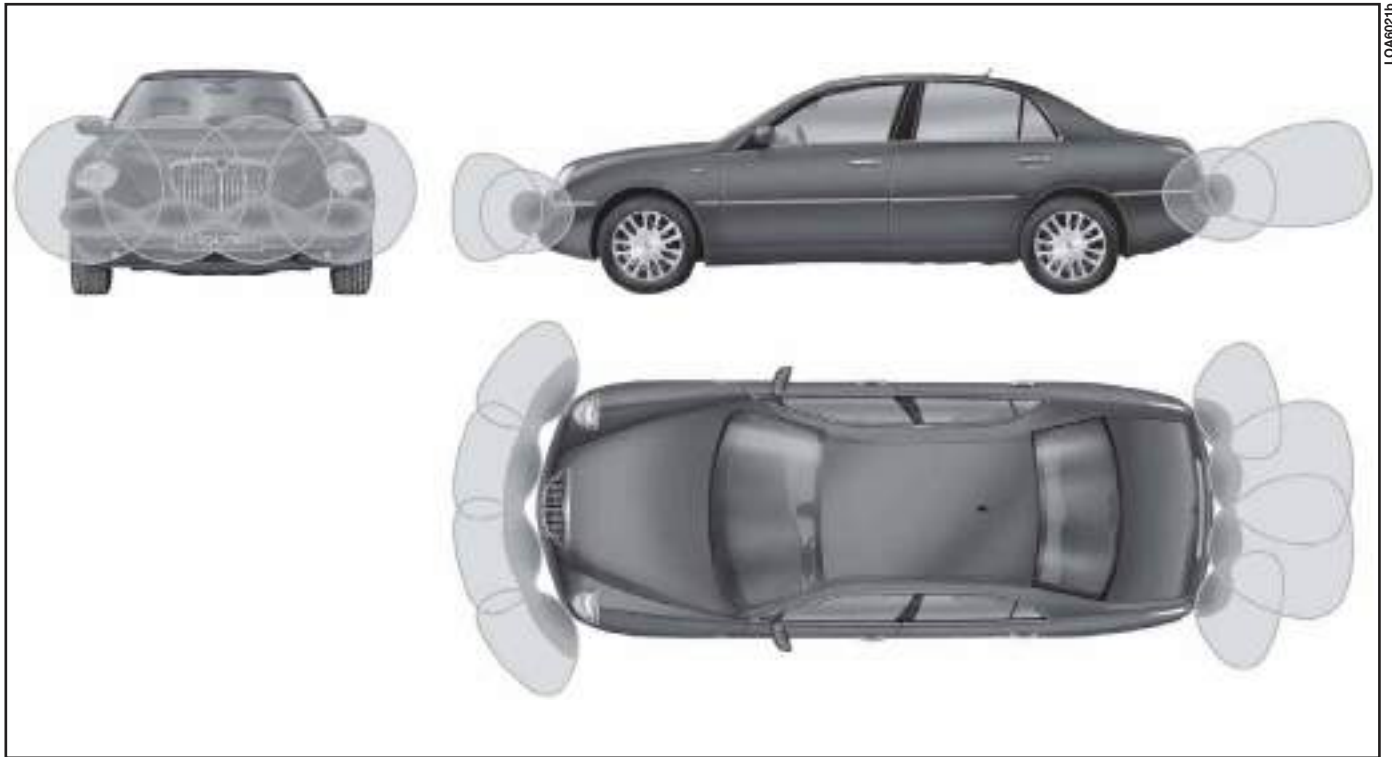

fig. 158

Obstacles placed in side areas are detected at a distance of less than 0.6 m.

TOWING A TRAILER



Rear sensors are automatically switched off when the trailer's electric cable plug is inserted into the car tow hitch socket.

Rear sensors are automatically switched on by removing the trailer cable plug.

FAULT INDICATIONS

The system control unit checks all the system components every time the ignition key is turned to **MAR**. Then, the sensors and their respective electrical connections are constantly monitored during system operation.

Parking assist system faults are signalled by the lighting of symbol **P**  on the multifunction display, together with message "PARKING SENSOR FAULT".

In case of fault signals, stop the car, shut the engine off, then try to clean the sensors, making sure that you are not close to ultrasound-emitting sources (e.g. truck air brakes or pneumatic hammers). If the cause of the operation anomaly has been remedied, the system fully resumes its functions and the fault symbol on the multifunction display goes out, together with its respective warning message.

If, on the contrary, the warning lamp remains on, go to a **Lancia Dealership** to have the system checked even if the system keeps on working. In fact, if the fault detected by the control unit does not affect the operation of the system, the latter keeps on working and the malfunction is stored in the memory so as to be detected by the **Lancia Dealership** during a subsequent check.

GENERAL NOTES

When parking your car, always pay the greatest attention to the obstacles that could be situated above or below the sensors. In fact, objects situated at close range in the car's front or rear parts could, under certain circumstances, not be detected by the system and, therefore, damage your car or be damaged themselves.

Moreover, signals sent by the sensors can be altered by damaged sensors, by accumulation of dirt, snow or ice on the sensors, or by ultrasound systems (e.g. truck air brakes or pneumatic hammers) being operated nearby.

INTERIOR EQUIPMENT

FRONT CEILING LIGHT (fig. 159)

This ceiling light includes a central light and two courtesy lights.

To switch the central light on manually, press button **A**; to switch it off, press the same button again. The light will light up and go out gradually. If the ceiling light has been switched on by means of the button, it will automatically go out after about 15 minutes after the engine has been shut off (by turning key to **STOP**).



fig. 159

To switch the courtesy lights on and off, press the respective buttons **B**. The courtesy lights will automatically go out after about 15 minutes after shutting the engine off (by turning the key to **STOP**).

The central ceiling light will switch on automatically, together with the rear ceiling light, when a door is opened. The ceiling lights will go out after about 3 minutes if one or several doors remain open or if the doors are closed beforehand, after about 10 seconds after the last door has been closed or at doors locking.

If a door is left open, the ceiling lights will automatically go out after about 3 minutes. To switch them on again, it is enough to open and close a door.

Ceiling lights come on (for about 10 seconds) when removing the ignition key (knob to **STOP** on cars fitted with Keyless System) and operating the central door opening with the remote control.

In case of collision with actuation of the inertial switch, the ceiling lights will automatically light up for about 15 minutes.

REAR CEILING LIGHT (fig. 160)

This ceiling light includes a central light and two courtesy lights.

The central light will switch on and off gradually, together with the front ceiling light.

To switch the central light on manually, press button **A**; to switch it off, press the same button again.

To switch the courtesy lights on and off, press the respective buttons **B**. The courtesy lights will automatically go out after about 15 minutes after the engine has been shut off (by turning the key to **STOP**).



fig. 160

DOOR PUDDLE LIGHTS (fig. 161)

A light is provided in the lower part of the door panel, to illuminate the area through which passengers get into and out of the car.

This light will automatically light up when the door is opened, regardless of the ignition key position.

With the door open, the light stays on for about 3 minutes, then it goes off automatically.



fig. 161

REARVIEW MIRROR LIGHTS (fig. 162)

The lower part of the external rearview mirrors incorporate a light to illuminate the area through which passengers get into and out of the car.

This light will automatically switch on, for about 3 minutes, when the door is opened or when the door lock is released by means of the remote control.



fig. 162

SUN VISORS (fig. 163)

The sun visors can swing up or down or be pivoted sideways.

Release the visors from hooks **A** to move them sideways.



fig. 163

COURTESY MIRRORS (fig. 164)

They are fitted on the back of the sun visors; they can be accessed by rotating the visors and lifting the cover **A**.

The mirrors are fitted with lights that will come on automatically when lifting the cover and will go out when lowering it again or automatically after 15 minutes after switching the engine off (ignition key at **STOP**).



fig. 164

FRONT ASHTRAY AND CIGAR LIGHTER

The ashtray and cigar lighter are protected by a single flap. Press the flap in the point shown (**fig. 165**).

Press button **A** (**fig. 166**) to work the cigar lighter. After a few seconds it will return to its initial position and be ready for use.

The cigar lighter will only work when the ignition key is at **MAR**.

Remove tray **B** to empty the ashtray.



Always verify that the cigar lighter has been switched off.



The cigar lighter gets very hot. Be careful how you handle it and make sure it is not used by children: danger of fire or burns.

REAR ASHTRAYS (**fig. 167**)

Two ashtrays are provided for rear seats: they are incorporated into rear door panels.

To open the ashtray, press on the point specified by the arrow.

To empty the ashtray, remove tray **A**.



LOAD1896

fig. 165



LOAD1896

fig. 166



LOAD0538

fig. 167

GLOVE COMPARTMENT

A glove compartment with light is located on the dashboard. The compartment has a flap and lock.

To open the glove compartment, press button **A** (fig. 168); the button works only when the key is at **MAR** and for about 1 minute after removing the key or turning it to **STOP**.

Glove compartment opening can be disabled and enabled again by means of the **CONNECT** menu.

When the glove compartment is opened, ceiling light **A** (fig. 169) will light up. The ceiling light can be switched off by closing the compartment, or automatically, after about 15 minutes after shutting the engine off (turning the key to **STOP**).

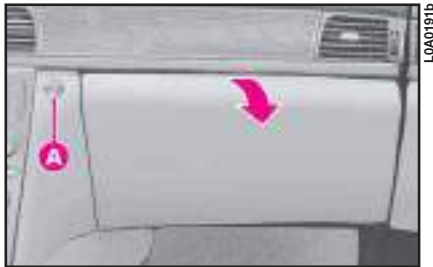



fig. 168

The lower part of the glove compartment houses the Compact Disc player **B** (CD-changer, where fitted) and, on certain versions, the power socket **C**.

IMPORTANT To use the power socket, read the instructions of the relevant paragraph in this chapter.

 Always close the glove compartment when the car is running: it could hurt the passenger in the event of an accident.

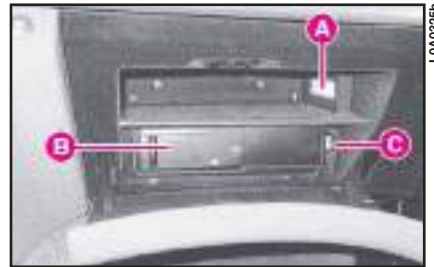

fig. 169

ODDMENT COMPARTMENT (fig. 170)

A pivoting oddment compartment is incorporated on the left side of the dashboard. To open the compartment, press on point **A**, then release it.

To close the compartment again, push it into its seat.

 Do not drive with the compartment open: it could hurt you in the event of an accident.



fig. 170

FRONT BOTTLE/CAN HOLDER (fig. 171)

It is incorporated into the front part of the central console.

To open the holder, press on point **A** then release it: the bottle/can holder will automatically open.

To close it, push cover **B** into its seat.



fig. 171

CLIMATE-CONTROLLED DRINK COMPARTMENT

The front armrest incorporates a climate-controlled drink compartment (fig. 172) fitted with a light, which receives air directly from the climate control system.

This compartment allows drinks to be kept as long as possible at the temperature they had when they were put inside the compartment.

The compartment can be accessed by lifting armrest **A** (fig. 173) by pulling it from handgrip **B**.



fig. 172

To open the compartment air vent, lift control **A** (fig. 173). To close the vent, lower control **A**.

To close the compartment, lower the armrest until it is locked; to lower it further, press handgrip **C**.

IMPORTANT This compartment is not a fridge or a drink warmer; it is used to maintain the temperature of the drinks put inside it. For this reason, the drinks must be warmed or cooled before being put inside the compartment.

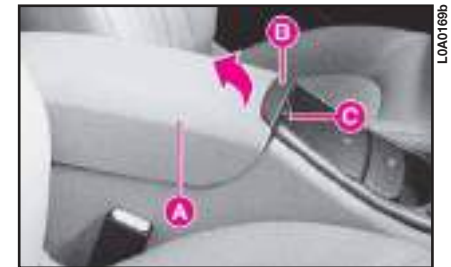

fig. 173



Take care not to spill the drinks. In any case, the compartment is provided with a hole on its bottom, through which any spilled liquid can be discharged.

ODDMENT COMPARTMENT ON THE DASHBOARD (fig. 174)

Oddment compartment A is placed in front of the gear lever.



fig. 174

DOOR POCKETS

Door pockets are located on the door panels:

- A (fig. 175) on front door panels
- B (fig. 176) on rear door panels.



fig. 175



fig. 176

CENTRAL CONSOLE COMPARTMENT (fig. 177)

Versions with automatic, two-zone climate control system are provided with an oddment compartment **A**, placed on the rear part of the central console.



fig. 177

REAR BOTTLE/CAN HOLDER (fig. 178)

Bottle/can holder **A** is incorporated in the rear armrest.

To open it, press on the point specified by the arrow, then release it: the bottle/can holder will automatically open.

To close the bottle/can holder, push it into its seat.



fig. 178

REAR ARMREST COMPARTMENT

Inside the rear armrest is an oddment compartment **A** (fig. 179), a card holder **B** and a power socket **C**.

Depending on versions, the armrest can also include:

- the control buttons for heating, massage, lumbar adjustment and for adaptation of rear side seats
- the button to shift the front passenger's seat
- the button to actuate the electric window shades



fig. 179

- the power socket
- the remote control used for the CONNECT HI-FI and TV functions
- the additional phone handset.

IMPORTANT To use the power socket, read the instructions of the relevant paragraph in this chapter.

The compartment can be accessed by lifting the armrest from handgrip **A** (fig. 180).

To close the compartment, lower the armrest.



fig. 180

POWER SOCKET

It is located inside the rear armrest.

The power socket can be accessed by lifting the armrest from handgrip **A** (fig. 180). To close the compartment, lower the armrest.

To use the socket, lift cover **C** (fig. 179).

Certain versions are fitted with a power socket inside the glove compartment.

The socket is powered when the key is turned to **MAR**. It can be used only for accessories with a maximum intake of 15A (power 180W).



Do not use the socket for power devices with a higher intake than that shown.

Prolonged current intake can drain the battery and lead to problems when starting the engine.

ELECTRIC SUNSHADE (fig. 181)

The electric sunshade works with ignition key at **MAR**.

The buttons for operating it are located on the central console, near the gearshift lever and inside the rear armrest.

To operate the electric sunshade from the front seats: press button **A** to open it and button **B** to close it.

To operate the electric sunshade from the rear seats: press the front part of button **C** to open it and press the rear part to close it.

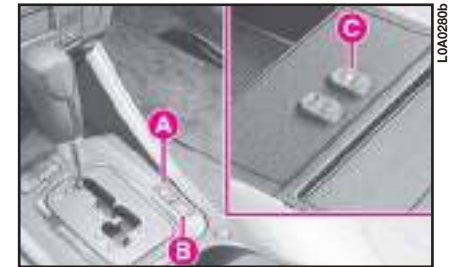

fig. 181



Before actuating the sunshade, make sure that no object is placed on the rear parcel shelf.

MAP POCKETS (fig. 182) (where provided)

Paper pockets are located on the back of the front seats.

HANDLES (fig. 183)

They are placed just next to the doors.

Each rear handle includes a clothes hook **A**.



fig. 182

ACCESSORIES PURCHASED BY THE USER

If after buying the car, you decide to install electrical accessories that require a permanent power supply (e.g. satellite antitheft device), or any other accessory that burden the electric supply, contact your **Lancia Dealership** whose qualified personnel, besides suggesting the most suitable devices belonging to the Lineaccessori Lancia, will also evaluate the total electrical absorption, checking whether the car's electric system is able to withstand the required load or whether it must be integrated with a more powerful battery.



fig. 183

INSTALLATION OF ELECTRIC/ ELECTRONIC DEVICES

Electric/electronic devices installed after buying the car or in aftermarket shall bear the and marking:



Fiat Auto S.p.A. authorizes the installation of transceivers provided that installation is carried out at a specialized shop, workmanlike performed and in compliance with manufacturer's specifications.

IMPORTANT Installation of devices resulting in modifications of car characteristics may cause driving license seizing by traffic agents and also the lapse of the warranty as concerns defects due to the abovementioned modification or traceable back to it directly or indirectly.

Fiat Auto S.p.A. declines all responsibility for damages caused by the installation of non-genuine accessories or not recommended by Fiat Auto S.p.A. and installed not in compliance with the specified requirements.

RADIO TRANSMITTERS AND CELLULAR TELEPHONES

Radio transceiver equipment (e.g.: e-tacs mobile phones, HAM radio systems and the like) shall not be used inside the car unless a separate aerial is mounted outside the car.

The use of these devices inside the passenger compartment (without external aerial) may cause electrical systems equipping the car to malfunction. This could compromise car safety in addition to constituting a potential hazard for the passengers.

In addition, transmission and reception of these devices may be affected by the shielding effect of the car body.

As concerns the use of mobile phones (GSM, GPRS, UMTS) provided with official EC approval, strictly comply with the instructions given by the mobile phone manufacturer.

SOLAR CELL OPERATED SUNROOF

The sunroof is electrically controlled and its operation is possible only with the ignition key at **MAR**. The sunroof can slide lengthwise, with various opening positions, until it fully retracts into the special housing, or can lift at the front (by pivoting) to allow passenger compartment aeration.

The upper part of the sunroof incorporates a set of solar cells that feed the climate control system fan at first speed when the car is parked to reduce the temperature inside the passenger compartment.

IMPORTANT Best operation of the fan when the car is parked is obtained by closing completely the windows and sunroof. Furthermore, to check operation at first speed of the fan, disengage air vents and set air distribution from central dashboard vents only before leaving the car.

The sunroof is equipped with an anti-trap safety system, which controls the closing lengthwise sliding as well as pivoting.

The electronic control unit that controls the system is able to detect the presence of obstacles when the roof is closing or pivoting at the rear; in this case, the system will interrupt the sunroof travel and immediately reverse it for a short stretch.



Improper use of the sunroof can in any case be dangerous, even if the anti-trap safety system is available. Before and during sunroof actuation, make sure that passengers are not exposed to the risk of injuries caused by the moving roof or by objects pulled or hit by the roof itself. Always remove the ignition key when you leave your car, to prevent the sunroof from being unintentionally actuated, which could be dangerous for the passengers inside the car.



The sunroof must not be opened in the presence of snow or ice; otherwise, it could be damaged.

IMPORTANT On versions fitted with the Keyless System, do not lay the CID device outside the car on the sunroof, to avoid a fake identification of the CID itself as if inside the car.

SUNROOF OPENING/CLOSING AND PIVOTING

All the sunroof functions (opening, closing and rear pivoting) are controlled by selector A (fig. 184).

Six positions for lengthwise opening and three for pivoting are provided (fig. 185).

After rotating the selector, the sunroof will move and stop automatically in the required position.

When the sunroof is opened, a deflector A (fig. 186) will automatically lift in the front part, which deviates the air flow.



LOA0281b

fig. 184



LOA0284b

fig. 185



LOA0282b

fig. 186



After battery disconnection or fuse interruption, the anti-trap system must be initialized again as follows:

1) turn selector A clockwise and fully to its stop, to position 3 corresponding to maximum pivoting (fig. 184)

2) keep selector A depressed until the sunroof jolts along to the maximum pivoting position

3) release the selector after the sunroof has stopped for at least 2 seconds

4) press, within 5 seconds, the selector again and keep it depressed

5) the sunroof will start moving within 5 further seconds and will perform a complete opening and closing cycle, after which it will stop in the closed position

6) release the selector after the sunroof has stopped for at least 2 seconds.

The system is thus initialized and resumes its normal operation. If this does not occur, contact your Lancia Dealership.

If the operation is interrupted before it is completed, repeat the procedure from the start.



Regularly check that the water draining holes A (fig. 187 set at the corners of the sunroof housing, are not obstructed.



LOA0263B

fig. 187

CENTRAL SUNROOF AND WINDOW LOCKING SYSTEM

Central locking/opening of sunroof and windows can be actuated at the following conditions:

- ignition key removed
- all doors closed correctly.

To actuate central locking by means of the remote control, keep button **B** (fig. 188) depressed for more than 3 seconds after closing the doors: the sunroof and window winders will be actuated until they are completely closed or the button is released.

To actuate central locking by means of the remote control, keep button **A** (fig. 188) depressed for more than 3 seconds after opening the doors: the sunroof and windows winders will be actuated until they are completely open or the button is released.

This function can be used before getting into the car when it has been parked in the sun, in order to aerate the passenger compartment.

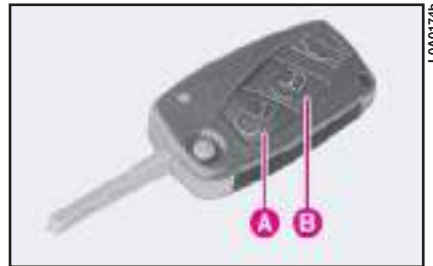

fig. 188

Central locking can also be actuated by turning the key in the lock of one of the front doors: keep the key turned to **2** (fig. 189) for more than 3 seconds. The sunroof and window winders are actuated until they are completely closed or the key is released.

By keeping the key turned to **1** (fig. 189) for more than 3 seconds, both the sunroof and all the windows will open. The sunroof and window winders are actuated until they are completely open or the key is released.



fig. 189

SOLAR CELLS

The upper part of the sunroof incorporates 21 solar cells that produce a maximum power of 24 W to feed the climate control system fan, when the car is parked with the sunroof closed or in pivoting position.

Fan actuation is automatic and air distribution corresponds to the latest setting made before switching the car off.

This function is useful especially on summer days, since it greatly reduces the temperature inside the passenger compartment as well as the duration of the cooling cycle after car start-up, thus avoiding the accumulation of warm air in the air-conditioning unit lines.

In winter, the ventilation function reduces dampness inside the passenger compartment.

EMERGENCY MANOEUVRE

In case the electric actuation device fails to operate, the sunroof can be actuated manually, proceeding as follows:

1) Take the Allen screw wrench **D** (fig. 191) out of the tool kit and use it to actuate the sunroof in an emergency.

2) Remove front ceiling light caps **A** and **B** (fig. 190) by levering with a screwdriver on the outer side (the caps are press-fitted).

3) Take out screws **C** (fig. 191) and remove the ceiling light by releasing it from the front clamps.

IMPORTANT Do not disconnect the ceiling light connectors.

4) Insert the Allen screw wrench **D** into the hexagonal seat of the sunroof starter motor, then turn it:

- clockwise to open the sunroof
- counterclockwise to close the sunroof.

5) After completing the closing or opening operation, put the ceiling light back to its place by fitting in the front clamps first and then fixing the rear screws.

IMPORTANT When refitting the ceiling light, check that the electric cables are positioned correctly.

6) Press-fit the screw cover caps.



fig. 190



fig. 191

BOOT

The boot can be opened both from the outside and the inside of the car.

IMPORTANT Faulty closing of the boot is signalled by the lighting of the relevant symbol on the multi-function display, together with message “BOOT OPEN”



fig. 192



With the battery flat, or after the interruption of one of the protection fuses, or if you want to disconnect a loaded battery (e.g. for a car stop period), before opening the luggage compartment bonnet carefully read and comply with the instructions contained in the paragraph “If battery is to be disconnected” in the chapter “In an emergency”.

OPENING FROM THE INSIDE

Boot tailgate is opened electrically. It can be opened only when the ignition key is at **MAR** and the car is stopped, or for 3 minutes after turning the key to **STOP** without opening or closing a door.

To open the boot, press button **A** (fig. 192), placed on the central console, as follows:

– a short pressure of the button will release the boot lock

– a prolonged pressure of the button will release the lock and open the boot.

Boot lifting is facilitated by the action of gas dampers.



The dampers are calibrated so as to ensure correct lifting of the boot tailgate with the weights established by the manufacturer. Addition of extra equipment (e.g. spoiler, etc.) can adversely affect operation and safety of use.

OPENING FROM THE OUTSIDE WITH THE KEY (fig. 193)

The boot lock is electrified: press button **A** on the tailgate to open it.

In an emergency (battery run down or electrical system failure), the tailgate can be opened by fully turning counterclockwise the key in the lock and exerting at the same time a slight pressure on the lower edge of the number plate holder to reduce the opening effort.

IMPORTANT If the boot was opened using the key, at closing the automatic function will be deactivated. To restore the automatic function press button **A**.



fig. 193

OPENING BY MEANS OF THE REMOTE CONTROL

The tailgate can be opened from the outside by pressing button **A** (fig. 194) on the remote control, even when the electronic alarm is on.

When the electronic alarm is on, boot opening is accompanied by double flashing of direction indicators; boot closing is accompanied by one flashing.

IMPORTANT If the boot is opened with the key when the electronic alarm is on, the latter will not be deactivated.



fig. 194

If the electronic alarm is on, both the volumetric protection and the boot control sensor will be switched off, and the system will emit (except for versions of certain markets) two beeps.

FUNCTIONS THAT CAN BE MODIFIED BY THE CONNECT MENU

The CONNECT enables to switch on/off the following functions:

- locking/unlocking the boot together with central door locking/opening

- automatic locking of the boot, door locks and fuel filler cap, when the car speed exceeds 20 km/h.

To actuate these settings, refer to the CONNECT supplement provided with the car.

The following tables summarize the operation logic of the boot lock, depending on the functions that have been actuated.

Boot lock opening/closing by remote control

| Central door locking system condition | Bound to central door locking | | Not bound to central door locking | |
|---------------------------------------|--|---|---|---|
| | Off | On | Off | On |
| To open the boot tailgate | Press tailgate button | Press remote control button A (fig. 194) , then press the tailgate button or keep remote control button depressed (more than 1 second) | Press remote control button A (fig. 194) , then press the tailgate button or keep remote control button depressed (more than 1 second) | Press remote control button A (fig. 194) , then press the tailgate button or keep remote control button depressed (more than 1 second) |
| To close the boot tailgate | When the boot is closed, the lock remains unlocked | When the boot is closed, the lock remains unlocked. To lock the tailgate lock, press remote control button B (fig. 194) | When the boot is closed, the lock remains unlocked. The lock will automatically lock when the car speed exceeds 20 km/h | When the boot is closed, the lock remains unlocked. To lock the tailgate lock, press remote control button B (fig. 194) |

Boot lock opening/closing by metal insert of the key

| Central door locking system condition | Bound to central door locking | | Not bound to central door locking | |
|---------------------------------------|--|---|--|---|
| | Off | On | Off | On |
| To open the boot tailgate | Press the tailgate button | Turn the key clockwise in the lock latch | Turn the key clockwise in the lock latch | Turn the key clockwise in the lock latch |
| To close the boot tailgate | When the boot is closed, the lock remains unlocked | When the boot is closed, the lock remains unlocked. To lock the tailgate lock, turn the key counterclockwise in the lock latch | When the boot is closed, the lock remains unlocked. To lock the tailgate lock, turn the key counterclockwise in the lock latch. In any case, the lock will automatically lock when the car speed exceeds 20 km/h | When the boot is closed, the lock remains unlocked. To lock the tailgate lock, turn the key counterclockwise in the lock latch |

CLOSING THE BOOT



To close the bonnet, lower it down until you lay it on the lock, without however slamming it. The lock is electric and the bonnet will close automatically.

BOOT CEILING LIGHT (fig. 195)

The boot is lit by ceiling light A, which switches on automatically when the tailgate is opened.

The light switches off automatically when the tailgate is closed.

If the tailgate is left open, the ceiling light will switch off after about 20 minutes; to switch it on again, close and then open again the tailgate.

LUGGAGE NETS

The boot is equipped with a fixed net (fig. 196) set on the left side, and (optional for versions/markets where applicable) a mobile net.

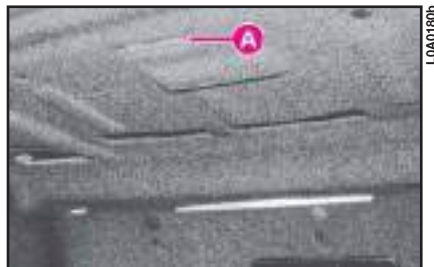

fig. 195



fig. 196

The mobile net can be secured to one of the two positions provided in the front part of the boot (fig. 197-198), by hooking it onto seats A and B (fig. 199).

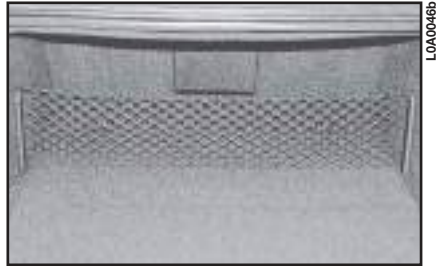

fig. 197

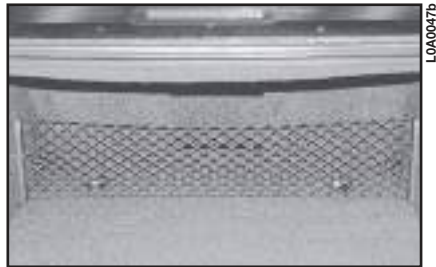

fig. 198

To secure the net, insert hooks A (fig. 200) in seats B then push downwards.

The net can be unhooked by slipping it off upwards, by pressing down button C on the attachment.

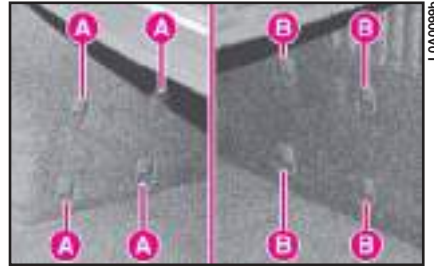

fig. 199

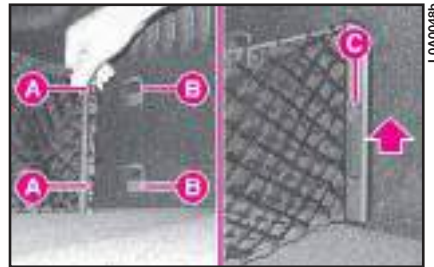

fig. 200

ANCHORING THE LOAD

The loads can be secured with belts (not provided), attached to the specific rings (fig. 201-202) in the boot corners.

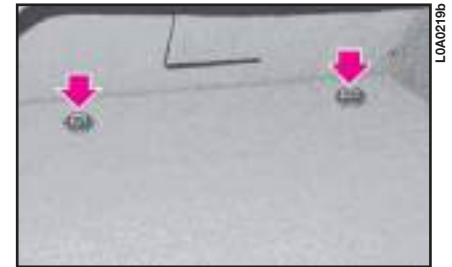

fig. 201

These rings can also be used to fasten the luggage net (optional, can be purchased at a **Lancia Dealership**).

LUGGAGE TRANSPORT - IMPORTANT

The car is equipped with a system that automatically keeps headlight height steady on different loading conditions. The adjusting system works properly with the maximum allowed loads: always make sure that the load you are carrying does not exceed the values specified in chapter “Technical Specifications”.



Heavy loads which are not securely anchored could seriously injure passengers in the event of an accident.

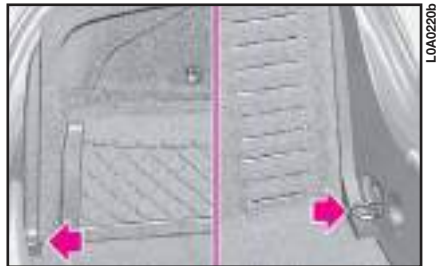

fig. 202



When using the boot, make sure the load you are carrying does not exceed the maximum allowed weight (see the “Technical Specifications” chapter). Also ensure the items in the boot are arranged properly and fastened with straps to the specific hooks to prevent them being thrown forwards and injuring passengers should you brake sharply.



If you need to carry petrol in a jerry-can, always comply with the law regulations and use a certified can, which must be properly secured to the fastening rings. In any case, the risk of fire in case of accident is high.

POWER SOCKET (fig. 203) (where provided)

It is located on the right-hand side of the boot.

Open cover **A** to use the socket.

The socket is powered when the key is turned to **MAR**. It can be used only for accessories with a maximum intake of 15A (power 180W).



Do not use the socket for power devices with a higher intake than that shown.

Prolonged current intake can drain the battery and lead to problems when starting the engine.

SKI TUNNEL (where provided)

The tunnel can be used to transport long objects (e.g. skis). Introduce objects into the tunnel from the boot.

Proceed as follows:

1) From the rear seat, lower the armrest using handle **A** (fig. 204).

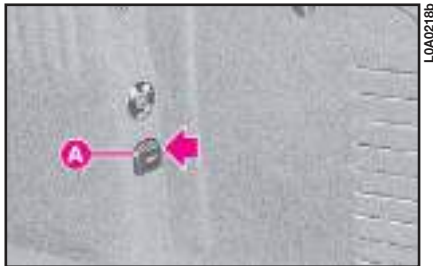

fig. 203

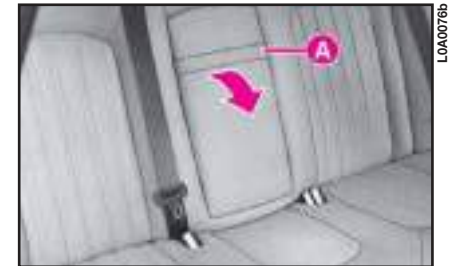

fig. 204

2) Lower the coating by pulling handgrip **B** (fig. 205).



fig. 205

3) Open the flap by pressing buttons **C** (fig. 206).

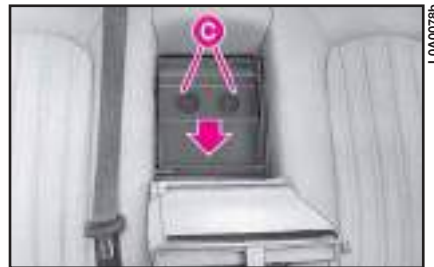

fig. 206

4) Take protection **D** (fig. 207) out and lay it on the armrest.



fig. 207

5) From the boot, lower the flap by pressing handle **A** (fig. 208).

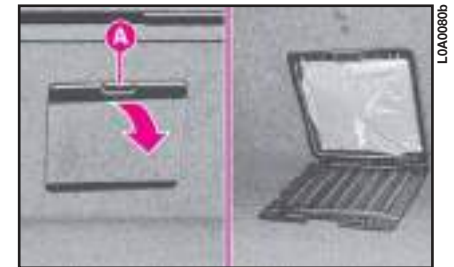

fig. 208

After placing the load with the protection, secure it by means of the belt to prevent it from shifting in case of sudden braking or collision.

To secure the protection with the load:

- 1) Get the protection belt to pass around the armrest.
- 2) Hold the belt tight by pulling its end, while holding buckle A (fig. 209).



fig. 209

3) Secure the load by inserting the attachment of belt A (fig. 210) into the buckle of the central rear safety belt.



fig. 210

To release the protection with the load:

- 1) Release the belt by pressing the button on the safety belt buckle.
 - 2) Loosen the tension of the belt by making the latter slide into buckle A (fig. 211) while pressing button B.
 - 3) Slip the protection belt from the armrest and fold it up into its seat.
- Close the flaps by pushing them into their seat to locking.



fig. 211

BONNET



Open the bonnet only when the car is stationary.

To open the bonnet:

- 1) Open the driver's door.
- 2) Pull lever A (fig. 212) in the direction shown by the arrow.



fig. 212



fig. 213



fig. 214

3) Lift lever B (fig. 213) and release the bonnet from the safety retainer.

4) Lift the bonnet.

IMPORTANT The bonnet is lifted by two gas struts (fig. 214). Do not tamper with the struts and follow the bonnet in its movement.



If repairs need to be carried out inside the engine compartment when this is still hot, be careful not to burn yourself and keep away from the electric fan as this may cut in at any time, even if the key is removed from the ignition switch. Wait until the engine has cooled.



Scarves, ties and other loose articles of clothing could easily get caught up in moving parts.

To close the bonnet:

Lower the bonnet at approx. 20 cm from the engine compartment and then let it drop, ensuring that it is fully closed and not just held in position by the safety catch. If the bonnet does not close properly do not push it down but open it again and repeat the above procedure.



For safety reasons the bonnet shall always be perfectly closed when travelling. Always check for proper bonnet locking. If the bonnet is left inadvertently open, stop the car immediately and close the bonnet.

FUEL FILLER CAP

The fuel filler cap flap is controlled automatically controlled by the central door locking system.

When central door locking is on, the fuel filler flap cannot be opened; when central door locking is off, the flap can be opened by simply pressing on the front part in point A (fig. 215).

Open the fuel filler flap by turning it in the direction shown by the arrow until it is completely opened.



fig. 215

In an emergency, the flap can be released by pulling wire **B** (fig. 216) on the right-hand side of the boot inside the service compartment.

To open the compartment flap, turn the catch **C** (fig. 217) to **1** using the ignition key and lower it.



fig. 216

IMPORTANT The airtight seal of the cap may lead to a slight increase of pressure in the tank. A hissing sound when the cap is removed is therefore quite normal.

The cap is equipped with a device which fastens it to the flap so that it cannot be misplaced **D** (fig. 218).

While you are filling up, fasten the cap to the device inside the flap as shown in the figure.

 **Do not put naked flames or lighted cigarettes near the fuel filler hole as there is a danger of fire. Do not bend too close to the hole either so as not to breathe in harmful vapours.**

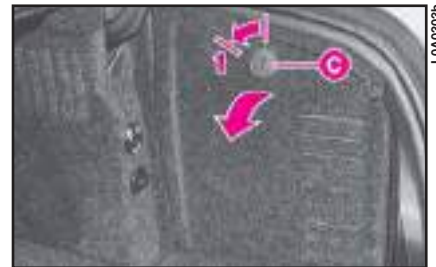

fig. 217

REFUELLING

To guarantee full tank filling, carry out two refuelling operations after the first click of the fuel delivery gun. Avoid further topping up operations that could cause damages to the fuel system.

IMPORTANT Refuelling shall always be performed with engine off and ignition key to **STOP**. If the engine is off but the key is to **MAR**, a wrong fuel level could temporarily be indicated. This is due to the internal system control logic and cannot be considered as a system malfunctioning.



fig. 218

DIESEL PARTICULATE FILTER (DPF) (2.4 JTD 20V CAE version)





The Diesel Particulate Filter is a mechanical filter, integral with the exhaust system, that physically traps particulate present in the exhaust gases of Diesel engines.

The diesel particular filter has been adopted to eliminate almost totally particulates in compliance with current / future law regulations.

During normal use of the car, the engine control unit records a set of data (e.g.: travel time, type of route, temperatures, etc.) and it will then calculate how much particulates has been trapped by the filter.

Since this filter physically traps particulates, it shall be cleaned (reclaimed) at regular intervals by burning carbon particles. Reclaiming procedure is controlled automatically by the engine control unit according to the filter conditions and the conditions of use of the car. During reclaiming the following phenomena could take place: idling slight increase, fan activation, slight smoke increase, high exhaust temperatures. These situations shall not be considered as faults and they do not affect car performance and environment.

Diesel particulate filter clogged

When the Diesel particulate filter is clogged, the instrument panel warning light  will turn on (on certain versions symbol  is displayed). In this case keep the car running until warning light  (or symbol ) turns off.

ROOF RACK – SKI RACK

ANCHORAGE POINTS

The car roof features four brackets for anchoring the roof rack/ski rack (fig. 219); these brackets are hidden by small covers.

To use the brackets, lift the covers by levering on point A (fig. 220).

Fasten the roof rack/ski rack to the brackets, by following the provided instructions.



fig. 219

After removing the roof rack/ski rack, lower the covers by engaging them into their seats.

IMPORTANT Strictly comply with the law regulations in force concerning maximum overall dimensions.

Strictly follow the assembly instructions provided with the roof rack/ski rack set. Assembly should be made by qualified personnel.

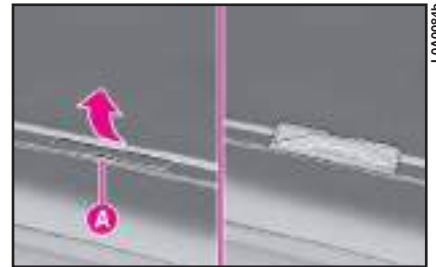

fig. 220



After travelling a few kilometres, check that the screws securing the rack are tight.



Distribute the load evenly and remember, when driving the car, that the car is now more susceptible to side wind.



Never exceed the permitted weights (refer to the “Technical specifications” chapter).

HEADLIGHTS

GAS-DISCHARGE (BI-XENO) MAIN BEAM / DIPPED BEAM HEADLIGHTS AND DYNAMIC BEAM ADJUSTMENT DEVICE

These headlights, called Bi-Xeno, use a lamp with a xenon-filled bulb, both for the dipped beam and the main beam headlights.

The main characteristics of this type of headlights are:

- higher brilliancy
- higher light beam width and adjustability
- lower consumption under working conditions
- longer bulb life.

Each headlight is equipped with an electronic control unit used to control supply voltage. Due to high brilliancy, bi-Xeno headlights require the adoption of a dynamic beam adjustment control system.

This system is controlled by an electronic control unit operating at two levels:

- constant headlight beam realignment as a function of the car load
- dynamic headlight beam alignment to compensate car pitching when running.

Operation

Light is projected onto the road by means of a spherical glass lens with a large surface (70 mm diameter).

A deflector lifts and lowers, so that light distribution is different for both the main beam and dipped beam headlights. The deflector is electrically operated and the mechanical lifting/lowering operation is performed real-time when lights are switched.

The xenon lamp consists of a bulb containing low-pressure xenon and two electrodes.

To obtain light emission, an electric arc must be triggered between the two electrodes and maintained.

Each headlight is equipped with a control unit which:

- checks the voltage/current value under working operation
- triggers the arc to the electrodes and cause salt evaporation at switching on.

Automatic dynamic beam adjustment device

Bi-Xeno headlights require, due to produced brilliancy, an automatic, dynamic beam adjustment system.

This system is managed by an electronic control unit that controls the actuators mounted on each dipped beam headlight. Actuator control depends on the processing of the signals from two orientation sensors.

This automatic dynamic beam adjustment system provides the following advantages:

- it avoids dazzling the vehicles coming from the opposite direction
- it stabilizes the illuminated area so as to improve active safety.

Headlight beam adjustment control unit

The control unit calculates the instant car trim, by comparing the signals from the orientation sensors.

A “correction” signal is sent to the actuators to adapt light beam orientation to the calculated car trim.

To avoid oscillation of the anti-dazzling beam in case of particular road surfaces (paved surfaces, dirt roads, etc.) or abrupt movements of the car caused by the driver (clutch disengagement, gear change, etc.), the control unit reduces the number of corrections to be made on the light unit.

Fault indication

Anomalies in the operation of one or several system components are signalled by the lighting of symbol  on the multifunction display, together with message “HEAD-LAMP INCLINATION ADJUSTMENT SYSTEM FAULT”.

IMPORTANT In case of faults, contact a **Lancia Dealership**.

In case of component anomaly or voltage drop, the system controls in any case system operation according to the following logic:

- faulty front sensor: trim calculation is made by replacing the voltage value read on the faulty sensor with a stored, fixed value
- faulty rear sensor: the system is switched to the safety operation mode and keeps the headlights in a preset position of maximum lowering allowed by the light beam.

– Failed connection of actuators: if the control signal is failing, the actuators will be brought back to the position of maximum lowering permitted for the light beam

– control unit failure: depending on the type of failure, the system can remain in the position where it was when the failure occurred, or set itself for the maximum lowering permitted for the light beam

– voltage drop: when voltage falls below 9 V, the system remains in the position where it was when the failure occurred.

HEADLAMP ORIENTATION FOR LEFT-/RIGHT HAND DRIVE

The car headlights are equipped with Bi-Xeno lamps with high lighting power; therefore, when you travel from a country with right-hand drive to one with left-hand drive, or vice versa, dipped beam headlight orientation must be modified.

This operation is necessary to avoid dazzling the vehicle coming from the opposite direction, as well as to optimize road edge illumination.



To carry out this operation, contact a Lancia Dealership.



When you go back to your country of origin, remember to have the dipped beam headlight orientation modified again.

EOBD SYSTEM



The EOBD (European On Board Diagnosis) system continuously monitors the engine emission system components. Furthermore, the system warns the driver of deterioration concerning the emission system components by means of the instrument panel warning light  coming on with message “ENGINE CONTROL SYSTEM FAULT”.

The objective is to:

- monitor system efficiency;
- warn when failures can increase emissions over the threshold established by the European regulations;
- warn of the need to replace deteriorated components.

Furthermore, the system is equipped with a connector for interfacing with specific tools used to read the error codes stored in the control unit memory along with a set of diagnostic and engine specific parameters. This check can also be performed by traffic controller agents.



Contact a Lancia Dealership as soon as possible if the instrument panel  warning light either does not come on when the key is turned to MAR or comes on, with fixed or flashing light, when travelling together with message “ENGINE CONTROL SYSTEM FAULT”. Warning light  operation can be checked by traffic controller agents. Comply with the regulations in force in the country where you are travelling.

IMPORTANT After eliminating the problem, your Lancia Dealership will run a bench test to fully check the system. In some cases, a long road test may be required.

ABS

GENERAL

If this is the first car with ABS you drive, get familiar with it by some preliminary “driving tests” on poor grip roadbeds, obviously under safety conditions and in compliance with the traffic regulations of the Country you are driving in. Read carefully the following instructions.

The ABS (wheel anti-locking) system prevents wheel locking and consequent slipping in all road surface conditions. This ensures greater control, as it is possible to steer and brake at the same time, and reduces braking space.

If the road conditions decrease the friction coefficient (i.e. due to the presence of water, snow, ice, etc.) a wheel may slip; in this case, the wheel does not ensure correct deceleration or the possibility of maintaining the running direction and the ability to steer. Here, the ABS

system comes into operation, eliminating hydraulic pressure only from the brake caliper of the locked wheel and, as soon as the latter start spinning again, brakes it again, thus ensuring optimum braking and car driveability.

EBD (ELECTRONIC BRAKE-FORCE DISTRIBUTOR)

The car is equipped with an electronic brakeforce distributor (EBD) which, by means of the ABS control unit and sensors, makes it possible to optimally distribute the braking force between the front and rear wheels, thus avoiding car skidding in the most difficult situations.

ABS OPERATION

The electronic control unit receives and processes the signals from the brake pedal and from the four sensors on the wheels. It consequently controls the hydraulic system so to decrease, hold or increase the pressure in the braking circuit of every single wheel, and prevent locking.

The main components of the ABS system are:



- an electronic-hydraulic control unit, which processes the signals from the various sensors and performs the most appropriate operations by acting on the solenoid valves
- four sensors which detect the rotation speed of every single wheel
- a pump provided with pressure switch, to restore brake fluid pressure.

IMPORTANT A slight pulsation of the brake pedal may be felt when the ABS system comes into play.



The coming on of the  warning light on the multifunction display, together with message “ABS SYSTEM FAULT”, when the engine is running, normally indicates a fault in the ABS system. In this case the braking system will still be effective although without the anti-lock device assistance. In these conditions, EBD system operation may also be reduced. Drive the car extremely carefully to the nearest Lancia Dealership to have the ABS system checked.



The car is fitted with an electronic brake force distributor (EBD). The  and  warning lights come on at the same time on the multifunction display, together with message “EBD SYSTEM FAULT”, when the engine is running to indicate that there is an EBD system failure. In this case violent braking may be accompanied by early rear wheel locking with the possibility of skidding. Drive the car extremely carefully to the nearest Lancia Dealership to have the system checked.



If warning light  comes on together with message “LOW BRAKE FLUID LEVEL”, on the multifunction display, stop the car immediately and contact a Lancia Dealership. Fluid leakage will compromise efficiency of both the traditional brake system and the ABS system.



The system performance in terms of active safety must not lead the driver to take unnecessary or unjustified risks. Always suit your driving style to the weather, visibility and traffic conditions.



Excessive use of engine braking (gears too short and limited grip) may make the wheels slip. The ABS will have no effect on this type of skidding.



The maximum possible deceleration always depends on the available road grip. Obviously, grip will be considerably decreased in the presence of snow and ice. In these conditions, the braking space will still be high, even with the ABS.

SOUND SYSTEM

The car is equipped with a complete sound system, consisting of the following:

- RDS-TMC radio integral with the CONNECT system
- audio CD/navigation CD-ROM player **A** (fig. 221) on the dashboard
- audio cassette player **B** on the dashboard



fig. 221

– multiple compact disc player (CD-changer) **C** (fig. 222) in the glove compartment (where fitted)

– BOSE HI-FI system (where fitted).

For detailed instructions on the Radio, CD and CD-Changer, refer to the CONNECT supplement provided with the car.

SPEAKERS

Front speakers (fig. 223)

The front speakers **A** are housed in front door panels.



fig. 222

Rear speakers (fig. 224)

The rear speakers **B** are housed in the rear door panels.



fig. 223



fig. 224

Speakers on the rear window shelf (fig. 225)

Speakers C are located at the ends of the rear window shelf.

BOSE HI-FI SOUND SYSTEM

The HI-FI sound system consists of:

- two high-performance woofers (168 mm diameter), fitted in front door panels
- two coaxial tweeters (50 mm diameter) built-into the front door woofers
- two high-performance, wide-band mid-range speakers (160 mm diameter), fitted in the rear door panels



fig. 225

- two high-performance sub-woofers (230 mm diameter), fitted on the rear window shelf

- speaker A (fig. 226) fitted in the upper central part of the dashboard

- one high-power hi-fi amplifier, five channels - four 25 W and one 100 W - class D, with analogue equaliser for signal amplitude and phase, fitted on the right-hand side of the boot A (fig. 227).

Total sound power: 300 W.

The HI-FI sound system was specifically designed for the THESIS to offer the best acoustic performance and the musical realism of a live concert in each seat in the passenger compartment.



fig. 226

System characteristics include crystalline treble and full, rich basses. Furthermore, the complete range of tones is played in the entire passenger compartment embracing the passengers with the feeling of space typical of live music.

The system components are patented and result from state-of-the-art technology. At the same time, the system is easy and intuitive to use and allows even the least experts to use the system to the best.



fig. 227

DRIVING YOUR CAR

STARTING THE ENGINE

IMPORTANT The car is equipped with electronic engine immobilising system. If the engine fails to start, see paragraph “Lancia CODE system”.



We recommend that during the initial period you do not drive to full car performance (e.g.: excessive accelerations, long journeys at top speed, sharp braking etc.).



It is dangerous to let the engine run in a garage or other closed area. The engine consumes oxygen and gives off carbon oxide, a poisonous gas.

The ignition device is fitted with a safety device which obliges the driver to return the key to **STOP** position before repeating the starting procedure.

In the same way, when the engine is running, this device prevents any shift from **MAR** to **AVV**.



Never leave the ignition key at **MAR** when the engine is off to prevent battery draining due to current absorption.

HOW TO START PETROL VERSIONS

IMPORTANT Never press the accelerator before the engine has started.

1) Ensure that the electric parking brake is on (instrument panel warning light  on).

2) Ensure that electrical systems and devices, especially high absorption ones (e.g. heated rear window), are off.

3) On versions with manual gearbox, set the gear lever to neutral and press the clutch pedal fully down to avoid the starter dragging the gears.

4) On versions with electronic automatic gearbox, ensure that the selector is at **P** and keep the brake pedal pressed.

5) Turn the ignition key to **AVV** and release it as soon as the engine starts.

6) If the engine fails to start, return the key to **STOP** and repeat the procedure.

IMPORTANT If the engine does not start at the first attempt, do not keep turning the ignition key to avoid damaging the catalyst. Contact a **Lancia Dealership**.

HOW TO START JTD VERSIONS

1) Ensure that the electric parking brake is on (instrument panel warning light  on).

2) Put the gear lever to neutral.

3) Turn the ignition key to **MAR**.

4) Wait until the  warning light is off: the hotter the engine is, the quicker this will happen.

When the engine is particularly hot the warning light may come on so quickly that it is impossible to notice it.

5) Press the clutch pedal down to the floor.

6) Turn the ignition key to **AVV** immediately after the  warning light goes out. If you wait too long, you will lose the benefit of the work done by the glow plugs.

IMPORTANT Energy-absorbing devices (climate control system, heated rear window etc.) are automatically disconnected at starting.

If the engine does not start at the first attempt, return the ignition key to **STOP** before trying to start the engine again.

If starting is particularly difficult, (with the Lancia CODE system working properly) do not keep trying too many times.

Use an auxiliary battery only if the battery has insufficient charge. Never use a battery charger to start the engine.

ENGINE WARMING UP

– Begin to move forward slowly letting the engine turn at medium revs. Do not accelerate abruptly.

– Do not push the engine to its limit for the first few kilometers. You are recommended to wait until the coolant temperature has reached 50 to 60 °C.

STOPPING THE ENGINE

– Release the accelerator pedal and wait until the engine is idling.

– Turn the ignition key to **STOP** and turn the engine off. For versions with electronic automatic gearbox, put the selector to **P** before turning the engine off.

IMPORTANT After a taxing drive you should allow the engine to “catch its breath” before turning it off by letting it idle to allow the temperature in the engine compartment to fall.



For cars equipped with turbosupercharger in particular, but generally for any kind of cars, avoid abrupt accelerations immediately before turning the engine off. A quick burst on the accelerator serves absolutely no practical purpose, wastes fuel and may damage seriously the turbosupercharger rotor bearings.

IMPORTANT If the engine turns off while the car is running, the Lancia CODE symbol  and the message “VEHICLE PROTECTION SYSTEM FAULT” may appear on the multifunction display when the engine starts again. In this case check that the warning light switches off when turning the engine off and on again with the car stationary. Otherwise contact a Lancia Dealership.

EMERGENCY START-UP

If the Lancia CODE system fails to recognise that code transmitted by the ignition key (symbol  together with message “VEHICLE PROTECTION SYSTEM FAULT” on the multifunction display) the emergency start-up can be performed by using the CODE card code.

For the correct procedure see chapter “In an emergency”.



Before opening the luggage compartment bonnet to reload the battery or to connect an auxiliary battery, carefully read and comply with the instructions contained in the paragraph “If battery is to be disconnected” in the chapter “In an emergency”.



Never bump start the engine (by pushing, towing or coasting downhill) as this could cause fuel to flow into the catalytic exhaust system and damage it beyond repair.



Remember that until the engine has started, the brake booster and power steering systems will not work and a greater effort will therefore be required to press the brake pedal and turn the steering wheel.

PARKING

To park the car, proceed as follows:

- Stop the engine.
- Check for electric parking brake engagement.
- Engage the 1st gear if the car is facing uphill or reverse if facing downhill.
- In automatic gearbox versions put selector to **P**.
- Leave the front wheels steered so to stop the car immediately if the parking brake is accidentally released.

On versions equipped with sunroof (where provided), the upper part of the sunroof incorporates a set of solar cells that feed the climate control system fan at first speed when the car is parked to reduce the temperature inside the passenger compartment.

IMPORTANT Best operation of the fan when the car is parked is obtained by closing completely the windows and sunroof. Furthermore, to check operation at first speed of the fan, disengage air vents and set air distribution from central dashboard vents only before leaving the car.



Never leave the ignition key at MAR when the engine is off to prevent draining the battery.



Never leave unsupervised children in the car; always remove the keys and take them with you when you leave the car.



If the CID device is inside the car, the engine can be started: therefore, we recommend that you take the greatest care since, in this circumstances, the engine could be started unlawfully or by children left unattended inside the car.

SAFE DRIVING

In designing THESIS, LANCIA has made every effort to come up with a car able to provide driver and passenger with top-class levels of safety. Nevertheless it is always the behaviour of the person at the wheel that determines road safety.

Below you will find some simple tips to help you travel in safety under different conditions. You will no doubt be familiar with many of them already, but it will be useful to read them all carefully.

BEFORE GETTING BEHIND THE WHEEL

- Make sure all lights, including the headlights, are working properly.
- Adjust the position of the seats, steering wheel, driving and door mirrors properly for the best driving position.
- Carefully adjust the head restraints so that the back of the head and not the nape of the neck is supported.

Make sure that nothing (mats etc.) gets in the way of the pedals when they are pushed down.

- Make sure that any child restraint systems (child seats, carriers etc.) are properly fixed on the rear seat.

- Place any objects in the boot in such a way that they cannot be thrown forwards in the event of an accident.

- Do not eat a heavy meal before travelling. Light eating will help keep your reflexes prompt. Above all, do not have anything alcoholic to drink.

Periodically, remember to check:

- tyre pressure and conditions;
- engine oil level;
- coolant level and cooling system conditions;
- brake fluid level;
- power steering fluid level;
- windscreen washer fluid level.

WHEN TRAVELLING

- The first rule of safe driving is prudence.

- Prudence also means putting yourself into a position where you can predict wrong or imprudent behaviour from other drivers.

- Stick closely to the rules of the road in the particular country where the vehicle is being driven and, above all, do not exceed speed limits.

- Ensure that, besides yourself, all the other passengers in the vehicle have their seat belts fastened, that children are sitting in the appropriate child seats and any animals in the car are placed in suitable compartments.

- You should be physically fit and mentally alert before setting out on long journeys.



Driving while drunk or under the influence of drugs or certain medicines is dangerous both for you and other road users.



Take care when fitting additional spoilers, alloy rims and wheel caps: they might reduce ventilation of the brakes, thus their efficiency during abrupt braking or long downhill slopes.



Make sure that any mats are appropriate in size: any hindrance, even slight, to the braking system may require a higher pedal stroke than normal.



Always fasten both front and back seat belts, including child restraint systems if there are children travelling with you. Travelling with seat belts unfastened increases the risk of injury or death if you are involved in a collision.



Never drive with objects on the floor in front of the driver's seat: they might get stuck under the pedals making it impossible to accelerate or brake.



Water, ice and salt on the road may deposit on brake disks, reducing braking efficiency the first time they are used.

- Do not drive too many hours at a time but stop at intervals to stretch your legs and recoup your energy.

- Make sure the air in the car is being changed continuously.

- Never coast downhill (i.e.: with the engine off); if you do, you lose the aid of engine braking and power brakes so that braking requires greater effort.

DRIVING AT NIGHT

There are the main rules to follow when you are driving at night.

- Drive especially carefully: it is harder to drive at night.

- Slow down especially if the road is not lit.

- At the first signs of sleepiness, stop: continuing would be a risk for yourself and everybody else. Only start driving again when you have had enough rest.

- Keep a greater safety distance from the cars in front of you than during daylight hours: it is hard to judge how fast other cars are going when all you can see are their lights.

- Only use main beam headlights when you are driving outside town and when you are sure they do not annoy other drivers.

- Dip your headlights as soon as you see cars coming in the other direction and pass them with the headlights dipped.

- Keep all lights clean.

- Be careful of animals crossing the road when driving in the country.

DRIVING IN THE RAIN

Rain and wet road surfaces spell danger.

All manoeuvres are more difficult on a wet road because the grip of the wheels on the tarmac is greatly reduced. This is why braking distances are much longer and road-holding is lower.

Here is some advice for driving in the rain:

- Reduce speed and maintain a greater safety distance from the cars in front.

- If it is raining particularly heavily, visibility is also reduced. In these cases, switch on the dipped headlights even if it is still daylight so you can be seen more easily.

- Do not drive through puddles at speed and hold on tightly to the wheel if you do: a puddle taken at high speed might cause you to lose control of the car (“aquaplaning”).

- Move the ventilation controls to the position for demisting the windows (see the section “Getting to know your car”), so to avoid visibility problems.

- Periodically check the condition of the windscreen wiper blades.

DRIVING IN FOG

If the fog is thick, do not start out on a journey unless you absolutely have to. If driving in mist, blanket fog or when there is danger of fog patches:

- Keep your speed down.
- Turn on the dipped headlights, rear fog lights and front fog lights even during the day. Do not drive with your headlights at main beam.

IMPORTANT On stretches of road with good visibility, switch off your rear fog lights; the brightness of these lights could annoy the people travelling in the cars behind.

- Remember that fog also means the tarmac is very wet and therefore manoeuvres of all kinds are more difficult and stopping distances are longer.
- Keep a good distance from the cars in front of you.
- As far as possible, avoid spurts of speed or sudden decelerations.

– Do not overtake other vehicles if you can help it.

– If you are forced to stop your car (breakdown, limited visibility etc.), try to stop off the road. Turn on the hazard lights and, if possible, the dipped beam headlights. Rhythmically sound the horn if you realise another car is coming.

DRIVING IN THE MOUNTAINS

– When driving downhill use the engine braking effect by engaging a low gear so as not to overheat the brakes.

– Under no circumstances should you drive downhill with the engine off or with the gear in neutral, let alone with the ignition key out.

– Drive at a moderate speed without cutting corners.

– Remember that overtaking while going uphill is slower and therefore requires more free road. If you are being overtaken while driving uphill, make it easier for the other vehicle to pass.

DRIVING ON SNOW AND ICE

– Here are some tips for driving in these conditions:

- Keep your speed down.
- Use winter tyres or snow chains for driving on snow covered roads; see the respective paragraphs in this chapter.
- Prevalently use the engine brake and avoid sudden braking.
- Do not accelerate suddenly and avoid swerving.
- In winter, even apparently dry roads may have icy patches. Be careful therefore when driving over stretches that do not get much exposure to the sun or are lined with trees or rocks where ice might not have melted.
- Keep a good distance from the vehicles in front.

DRIVING WITH ABS

The ABS is a braking system that essentially offers two advantages:

- 1) It prevents wheel lock and consequent skidding in emergency stops, particularly when the road does not offer much grip.
- 2) It makes possible to brake and steer at the same time so you can avoid unexpected obstacles and direct the car where you want while braking.

To get the most out of ABS:

- During emergency stops or when grip conditions are very poor, you will feel a slight pulsation on the brake pedal. This is the sign that the ABS is working. Do not release the brake pedal but continue to press so as not to interrupt the braking action.

– The ABS prevents the wheels from locking, but it does not increase actual grip conditions between tyre and road. Therefore, even if your car is fitted with ABS, keep a safe distance from the car in front of you and keep your speed down when driving into bends.

ABS serves to increase your control over the car, not to enable you to go faster.

CONTAINING RUNNING COSTS AND POLLUTION

Some suggestions which may help you to keep the running costs of the car down and lower the amount of toxic emissions released into the atmosphere are given below.

GENERAL CONSIDERATIONS

Car maintenance

The overall state of the car is an important factor which has a marked influence over fuel consumption and driving comfort and on the life span of your car. For this reason care should be taken to maintain your car by carrying out the necessary checks and regulations in accordance with the specifications given in the "Service Schedule" (see sections: spark plugs, air cleaners, timing...).

Tyres

Tyre pressure should be checked at least once every four weeks: if the pressure is too low fuel consumption increases as the resistance to the rolling movement of the tyre is greater. In this state, tyre wear is increased and handling suffers, which will effect safety.

Unnecessary loads

Do not travel with too much load in the boot. The weight of the car (in town traffic above all), and its trim greatly effect consumption and stability.

Roof rack/ski rack

Remove the roof or ski racks from the car as soon as they are no longer needed. These accessories reduce the aerodynamic penetration of the car and will increase consumption. When transporting particularly large objects, use a trailer, where possible.

Electrical devices

Use electrical devices for the necessary time only. The heated rear window, fog lights, windscreen wipers, heater fan require large amounts of electricity and increasing the request for power will also increase fuel consumption (up to +25% when driving in towns).

Climate control system

The climate control system is an additional load which greatly effects the engine leading to higher consumption (up to +20% in average). When the temperature outside allows, use the air vents where possible.

Spoilers

The use of optional extras which are not certified for specific use on the car may reduce the aerodynamic penetration of the car and increase consumption.

DRIVING STYLE

Starting

Do not warm the engine when the car is stationary or at high or low revs: in this way the engine will warm up gradually increasing consumption and emissions. You should drive off slowly straight away avoiding high revs so that the engine will warm up more quickly.

Unnecessary actions

Avoid revving the engine when stopped at traffic lights or before switching off the engine and avoid doubling the clutch as these actions have no purpose on modern vehicles and serve only to increase consumption and pollution.

Gear selections

As soon as the traffic and road conditions allow it, shift to a higher gear. Using a lower gear to liven up acceleration greatly increases consumption. In the same way, improper use of the higher gears will increase consumption, emissions and wear and tear on the engine.

Top speeds

Fuel consumption increases considerably as speed increases. For example, when accelerating from 90 to 120 km/h, fuel consumption increases up to approximately +30%. Your speed should be kept as even as possible and superfluous braking and acceleration avoided, as this increases both consumption and emissions. A “smooth” driving style should be adopted by attempting to anticipate manoeuvres to avoid imminent danger, and to keep a safe distance from the vehicle in front to avoid braking sharply

Acceleration

Accelerating violently increasing the revs will greatly effect consumption and emissions: acceleration should be gradual and not exceed the maximum torque.

CONDITIONS OF USE

Cold starting

Frequent cold starting will not enable the engine to reach optimal running temperature. It follows, therefore, that consumption will be higher (from +15 to +30% in towns) as will the production of toxic emissions.

Traffic and road conditions

Heavy traffic and higher consumption are synonymous, for example when driving slowly with frequent use of lower gears or in towns where there are numerous traffic lights.

Winding roads, mountain roads and bumpy roads also have a negative effect on consumption.

Enforced halts

During prolonged stops (level crossings, etc.) the engine should be switched off.

CHEAP RUNNING THAT RESPECTS THE ENVIRONMENT

Environmental protection has been one of the guiding principles in the production of the THESIS.

It is not accident that its pollution control equipment is much more effective than that required by current legislation.

Nonetheless, the environment cannot get by without a concerted effort from everyone.

By following a few simple rules you can avoid harming the environment and often cut down fuel consumption at the same time. On this subject, a few useful tips have been given below to supplement those marked by symbol , at various points of the handbook.

You are asked to read both the former and the latter carefully.

LOOKING AFTER EMISSION CONTROL DEVICES

The correct use of pollution control devices not only ensures respect for the environment but also has an effect on the car's performance. Keeping these devices in good condition is therefore a fundamental rule for driving that is easy on your pocket and on the environment too.

The first step is to follow the "Service Schedule" to the letter. Only use unleaded petrol for petrol engines (95 RON), for JTD versions only diesel fuel (EN590 specification).

If you have trouble starting, do not keep turning the ignition key for long periods. Be especially careful to avoid bump starting the car by pushing, towing or rolling downhill: these are all manoeuvres that can damage the catalytic exhaust system. Use an auxiliary battery for start-ups only.

If the engine begins to “lose its smoothness” when travelling, continue your journey but reduce the demands you are making on the engine and have the car seen at a **Lancia Dealership** as soon as you can.

When the instrument panel fuel reserve warning light comes on, fill up as soon as possible. A low level of fuel can cause an uneven supply of fuel to the engine with the inevitable increase in the temperature of the exhaust gas and serious damages to the catalytic converter.

Never run the engine with the spark plugs disconnected even for testing purposes. Do not warm up the engine by letting it idle for a while before moving off unless the outside temperature is very low and, even in this case, only do so for less than 30 seconds.



Do not install other heat shields and do not remove those already fitted to the catalytic converter and exhaust pipe.



Do not allow anything to be sprayed onto the catalytic converter, lambda sensor and exhaust pipe.



When functioning normally, the catalytic converter reaches high temperatures. For this reason, do not park the car over inflammable material (grass, dry leaves, pine needles, etc.): fire hazard.



Ignoring the above rules may lead to fire.

TOWING A TRAILER

GENERAL NOTES

The car must be fitted with a homologated tow hitch and suitable electrical system for towing a caravan or a trailer. Have the tow hitch fitted by an expert who will issue specific documentation for use on roads.

Fit special and/or additional rearview mirrors in accordance with the highway code.

Remember that towing a trailer makes it harder for the car to climb the maximum gradients specified, increases braking and overtaking distance, proportionally to the overall weight of the trailer.

Engage a low gear when driving downhill rather than constantly braking.

The weight the trailer exerts on the car's tow hitch coupling reduces the car's loading capacity by the same amount. In order to be sure you are not exceeding the maximum towing weight (as specified in the registration book), you have to take into account the trailer's fully laden weight, including accessories and personal luggage.

Do not exceed the speed limits for towing a trailer in the country you are driving in. In any case, do not exceed the top speed of 100 km/h.

Trailer electrical connection shall only be performed with ignition key at **STOP** or removed.

When trailer electrical connection is on and you switch on the rear fog lights, only the trailer rear fog lights will come on.



The ABS system will not control the trailing braking system. Great care should therefore be taken when driving on slippery road surfaces.



Under no circumstances modify the car's braking system for trailer braking control. The trailer's braking system must be completely independent of the car's hydraulic system.



The rear parking sensors are automatically deactivated when the plug of the trailer's electrical cable is inserted in the car's tow hitch socket. The rear sensors activate automatically when the trailer's plug is disconnected.

TOW HITCH INSTALLATION

The tow hitch must be fixed to the body by an expert in accordance with the following instructions and respecting the additional and/or integrative information provided by the tow hitch manufacturer.

The tow hitch to be fitted must comply with the current regulations in force, with reference to Directive 94/20/EEC and subsequent modifications.

Use a tow hitch suited for the maximum towable load of the car version on which the tow hitch is to be fitted.

Use a unified coupling for the electrical connections. The coupling is generally fitted on a specific mount fastened to the tow hitch. A specific trailer lights control unit shall be installed on the car.

For the electric connections, a 7 pole 12VDC coupling must be used (CUNA/UNI and ISO/DIN standards). Follow the instructions provided by the manufacturer of the car and/or the tow hitch.

The electrical brake (where relevant) or other device (electrical winch, etc.) must be powered directly from the battery by means of a lead with a cross-section area no smaller than 2.5 mm².

IMPORTANT Use the electrical brake or winch only when the engine is running.

In addition to the electrical connections, only the power wire for an additional electrical brake and for internal trailer lighting with a power not exceeding 15W can be connected to the car's electrical system.

For connections use the specific control unit with battery cable not less than 2.5 mm².

INSTALLATION DIAGRAM (fig. 1)

Fasten the tow hitch in the points marked with (1) using 18 M10 screws and, in the points marked with (2) use four M8 screws.

Fasten the tow hitch to the body avoiding any type of drilling and trimming of the rear bumpers that remains visible when the tow hitch is removed.

IMPORTANT Fasten a tag in a clearly visible position at the same height as the tow hitch. The tag is compulsory. It must be adequately sized, made of suitable material and carry the following information:

MAX LOAD ON BALL COUPLING
75 kg.

After assembly, seal the fastening screws holes to prevent exhaust fumes from entering the passenger compartment.

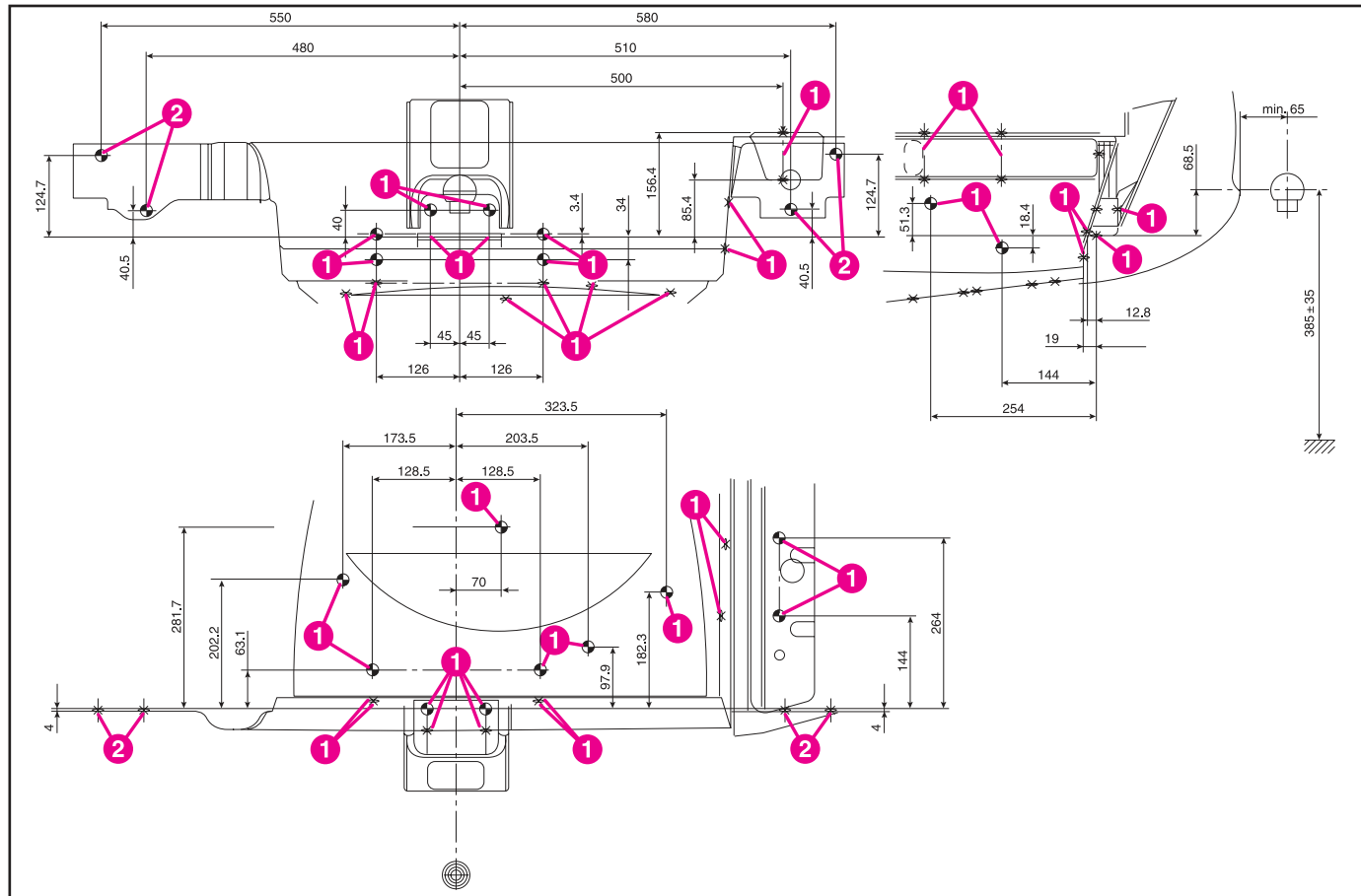

fig. 1

LOA0264b

WINTER TYRES

These tyres have been specifically designed for use on snow and ice and should be fitted in place of the existing tyres.

Use only the homologated tyres listed in log book.

Lancia Dealerships will be glad to provide advice on the most suitable type of tyres according to your needs.

For information on the tyres to be fitted, inflation pressure and winter tyre specifications, follow the prescriptions given in “Technical specifications”.

The performance of winter tyres is greatly reduced when the tread depth is less than 4mm. In this situation it would be safer to have them replaced.

Due to winter tyre features, under normal conditions of use or on long motorway journeys, the performance of these tyres is lower than that of standard tyres.

The use of these tyres should therefore be limited to the conditions for which they were designed and certified.

IMPORTANT When using winter tyres with a maximum speed index below the one that can be reached by the car (increased by 5%), place a suitable notice in the passenger compartment to inform the driver of the top speed at which the winter tyre can run (as per EC Directive).

All four tyres should be the same (brand and track), to ensure greater safety when driving, braking and cornering.

Remember that it is inappropriate to change the direction of rotation of tyres.

The maximum speed for winter tyres with “Q” marking is 160 km/h, with “T” marking is 190 km/h, whereas with “H” marking is 210 km/h. Always respect the highway code speed limit.

SNOW CHAINS

The use of snow chains is regulated by the legislation in force in the country the car is driven in.

Snow chains must only be applied to the driving wheels (front wheels).



Refer to the following table for information on the wheels where snow chains can be fitted; follow the prescriptions.

We recommend to contact a **Lancia Dealership** before buying or installing snow chains.

Check the tautness of the chains after driving some ten metres.



Snow chains cannot be fitted on 225/50R17 (94W), 225/50ZR17 (94W) and 245/40ZR18 tyres, since they interfere with the front suspension.



Disconnect the ASR system when snow chains are fitted. Press the ASR-OFF button: button led on.



Keep your speed down when snow chains are fitted. Do not exceed 50 km/h. Avoid potholes, steps and pavements and do not drive for long distances on roads not covered with snow to prevent damaging the car and the roadbed.

| Versions | Tyres on which chains can be fitted | Type of snow chains to be used |
|---|---|--|
| 2.0 TB | 215/60 R16 95W 215/60 ZR16 95W 215/60 R16 95H M+S | Low profile snow chains with maximum height off the tyre of 10mm |
| 2.4 - 2.4 CAE | 215/60 R16 95W 215/60 ZR16 95W 215/60 R16 95H M+S | |
| 2.4 JTD 2.4 JTD 20V 2.4 JTD 20V CAE | 215/60 R16 95W 215/60 ZR16 95W 215/60 R16 95H M+S | |
| 3.0 V6 CAE 3.2 V6 CAE | 215/60 R16 95W 215/60 ZR16 95W 215/60 R16 95H M+S | |

STORING THE CAR

The following precautions should be taken if the car will not be used for several months:

- Park the car in covered, dry and if possible well-ventilated premises.
- Engage a gear.
- If the car is parked on flat ground, disengage the electric parking brake as described in the relevant paragraph.
- Clean and protect the painted parts using protective wax.
- Sprinkle talcum powder on the rubber windscreen and rear window wiper blades and lift them off the glass.
- Slightly open the windows.
- Inflate the tyres to 0.5 bar above the normal specified pressure, lean them on wood boards, if possible and check it at intervals.

- Do not switch the electronic alarm system on.

- Remove the negative cable (-) from the battery terminal and check the battery charge. This check should be performed every month if the car is to be stored for long periods. Recharge the battery if it falls below 12.5V.

IMPORTANT Before opening the luggage compartment bonnet to disconnect the battery, carefully read and comply with instructions contained in the paragraph “If battery is to be disconnected” in the chapter “In an emergency”.

- Do not drain the engine cooling system.
- Cover the car with a cloth or perforated plastic sheet. Do not use sheets of non-perforated plastic as they do not allow moisture on the body to evaporate.

USING THE CAR AGAIN

Before using the car again after a prolonged period of inactivity, the following operations are recommended:

- Do not dry-dust the car body.
- Check for fluid leaks (oil, brake and clutch fluid, engine coolant etc.).
- Change engine oil and filter.
- Check the level of:
 - brake and clutch fluid
 - engine coolant.
- Check the air cleaner and change it, if required.
- Check the tyre pressure and the tyres for signs of damage, cuts or cracks. If this is the case, have them replaced.
- Check the engine belt conditions.

– Reconnect the negative battery terminal (-) after checking the battery charge.

IMPORTANT Before connecting the battery again carefully read and comply with instructions contained in the paragraph “If battery is to be disconnected” in the chapter “In an emergency”.

– With the gear lever to neutral, start the engine and let it idle a few minutes, pressing the clutch pedal repeatedly.



This operation must be carried out outdoor. Exhaust gas contains carbon monoxide, an extremely toxic gas.

USEFUL ACCESSORIES

In addition to the legal requirements we recommend keeping the following in the car (**fig. 2**):

- first-aid kit with non-alcoholic base disinfectant, sterile gauze, a roll of gauze bandage, plasters, etc.,
- torch,
- round-nosed scissors,
- work gloves,
- fire extinguisher.

These articles are all available from Lineaccessori Lancia range.

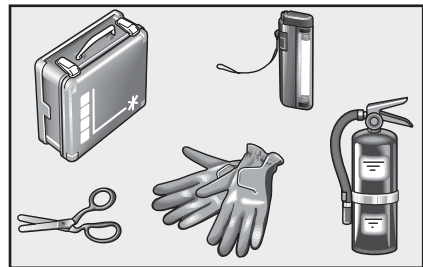



fig. 2

IN AN EMERGENCY



EMERGENCY START-UP

If the Lancia CODE system cannot deactivate the engine immobilising system, symbols  and  will remain lit on the multifunction display together with messages “ELECTRONIC KEY NOT RECOGNISED” and “ENGINE CONTROL SYSTEM FAULT”, and the engine will not start. Follow the emergency start-up procedure to start the engine.

Read the whole procedure carefully before trying to carry it out.

If you make a mistake in the emergency procedure you must turn the ignition key back to **STOP** and repeat the whole operation from the beginning (step 1).

- 1) Read the five-digit electronic code on the CODE card.
- 2) Turn the ignition key to **MAR**.

3) Press and hold down the accelerator pedal. The warning light  on the instrument panel will light up for about 8 seconds, and then go out. At this point release the accelerator pedal and get ready to count the flashes of the warning light .

4) Count the number of flashes that corresponds to the first figure of the code on the CODE card, then press the accelerator pedal and keep it down until the  warning light comes on for four seconds and then goes out. Release the accelerator pedal.

5) The  warning light will start flashing again: after it has flashed the number of times that corresponds to the second figure on the CODE card, press the accelerator pedal to the floor and keep it there.

6) Do the same for the remaining digits on the CODE card.

7) Once the final figure has been entered, keep the accelerator pedal pressed. The  warning light will light up for 4 seconds and then go out. Release the accelerator pedal.

8) The  warning light will flash rapidly for about 4 seconds to indicate that the operation has been completed correctly.

9) Start the engine by turning the ignition key from **MAR** to **AVV** (without turning it to **STOP**).

If, however, warning light  stays on, turn the ignition key to **STOP** and repeat the procedure from step 1).

IMPORTANT After an emergency start, you should contact a **Lancia Dealership** immediately as you will have to repeat the procedure described each time you want to start the engine.

JUMP STARTING

If the battery is flat, you can use another battery to start the engine. Its capacity must be the same or slightly greater than the flat battery (see the “Technical Specification” chapter).

The battery is placed on the left side of the boot, protected by a cover.



Before opening the luggage compartment bonnet to reload the battery or to connect an auxiliary battery, carefully read and comply with the instructions contained in the paragraph “If battery is to be disconnected” in the chapter “In an emergency”.

Jump starting does not damage the Lancia CODE system. Proceed as follows:

- 1) Disconnect all electrical devices that are not strictly useful.
- 2) Lift the boot tailgate by turning the key metal insert clockwise in the latch.

3) Loosen the knob **A** (fig. 1) and remove the protective cover **B**.

4) Press flanges **A** (fig. 2) and remove the cover **B**.

5) Connect the positive terminals (+) **A** (fig. 3) and **B** of the two batteries with a jump lead.

6) With a second lead connect first the negative terminal (-) **C** of the auxiliary battery and then the earth braid **D** of the car to be started.

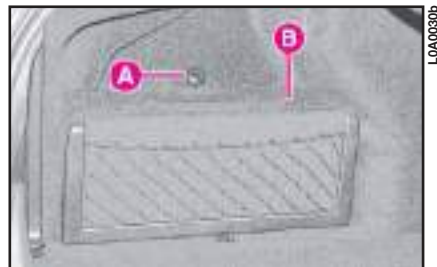

fig. 1

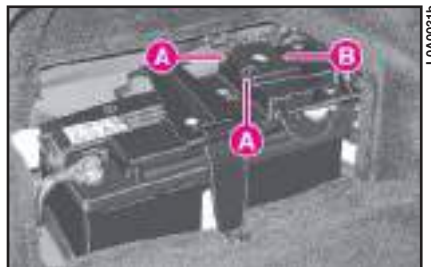

fig. 2

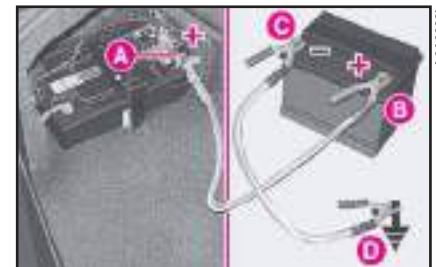

fig. 3



Never connect the negative terminals of the two batteries directly: sparks could ignite the flammable gas from the battery. If the auxiliary battery is installed on another car, prevent accidental contact between the metal parts of the two vehicles.

7) Start the engine.

8) When the engine has started, remove the leads in the reverse order to before: **D, C, B** and finally **A**.

IMPORTANT If the engine fails to start after a few attempts, do not keep turning the key but have the car seen to at a **Lancia Dealership**.

9) Put the cover back on the battery positive terminal by fitting the lock flanges in.

10) Put the cover back and retighten the knob.

11) Close the boot tailgate.

IMPORTANT When the tailgate is closed, the boot latch is not locked. To lock it, turn the metal insert of the key anticlockwise in the latch.



Do not carry out this procedure if you lack experience: if it is not done correctly it can cause very intense electrical discharges and the battery might even explode. Do not to put naked flames or lighted cigarettes near the battery and do not cause sparks: risk of explosion and fire.



Never use a battery charger to jump start the engine: you could damage the electronic system, with special reference to ignition and injection control unit.

BUMP STARTING

Do not bump start by pushing, towing or coasting downhill. This way of starting could cause a rush of fuel into the catalytic converter and damage it beyond repair.

Remember that if the engine is not running, the brake booster and the power steering will not work. You therefore have to use considerably more effort on both the brake pedal and the steering wheel.

IF A TYRE IS PUNCTURED

Follow the instructions on this and the following pages to use the jack and the spare wheel correctly.



Signal the presence of the stopped car according to the laws in force: hazard lights, reflecting triangle, etc.

Passengers should get out of the car and stay clear from oncoming traffic while the wheel is being changed.



If the wheel is being changed on a steep or badly surfaced road, place wedges or other suitable material under the wheels to stop the car from moving.

Have the punctured tyre repaired and fitted back as soon as possible. Do not lubricate the bolt threads before fitting them back: they could come loose.



Wheel bolts are specific for the type of rim (alloy or steel) fitted. Never use, also if in an emergency, wheel bolts for another type of rim. When changing rims (alloy rims instead of steel ones or vice versa), also the whole wheel bolt set shall be changed with other bolts specific for the new type of rim adopted.



The jack should only be used to change a wheel on the car for which it was designed. It should not be put to other uses or employed to raise other models of car. Under no circumstances should it be used when carrying out repairs under the car.

An incorrectly positioned jack may cause the car to fall.

Do not use the jack to lift loads exceeding those indicated on the label attached to the jack itself.

The wheel cap may fly off when the car is moving if it is not fastened correctly. Never tamper with the inflation valve. Do not insert tools between the rim and the tyre.

Check the tyre and spare wheel pressure regularly. Tyre pressure is shown in the “Technical Specifications” chapter.

CHANGING A WHEEL

Please note:

- the jack weighs 2.100 kg;
- the jack requires no adjustments;
- the jack cannot be repaired. If it breaks, it must be replaced with a genuine spare part;
- no other tool, part from the ratchet wrench, can be fitted to the jack.

Change the wheel as follows:

- 1) Stop the car so that it is not a hazard for other road users or yourself when changing the wheel. The ground should be as flat and firm as possible.
- 2) Turn engine off and engage the electric parking brake.
- 3) Engage first gear or reverse. On versions with automatic gearbox shift the lever to **P**.

4) Open the boot.

5) Fold the boot carpet **A** (fig. 4).

6) Take out the warning triangle **A** (fig. 5) and the tool kit **B**.

7) Release the locking device **A** (fig. 6) and take out the jack holder **B** and the spare wheel **C**, then place them next to the wheel to be changed.



fig. 4



fig. 5

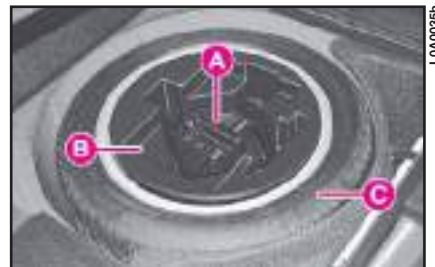

fig. 6

8) Unscrew manually the jack handle **A** (fig. 7) and remove it from the container **B**.

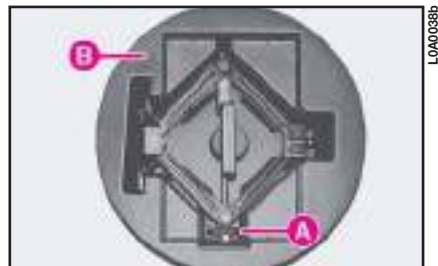

fig. 7



fig. 8

9) Open the tool bag and take out the tools to be used (fig. 8):

- 1 – tow ring
- 2 – flat/cross-head screwdriver
- 3 – ratchet wrench
- 4 – ratchet wrench bush
- 5 – wheel bolt (for versions with alloy rims)
- 6 – tool for removing the hub cap (for versions with alloy rims)
- 7 – bush for unscrewing/screwing the wheel bolts by hand



fig. 9

8 – wrench for power steering reservoir cap screws

9 – wrench for actuating the sunroof in an emergency (where fitted)

10) On versions with alloy rims, remove the press-fit wheel hub cap **A** (fig. 9), pulling it by tool **B** fitted into **C**. On versions with steel rims, remove the press-fit wheel cap **A** (fig. 10).



fig. 10

11) Place the bushing **A** (fig. 11) for the wheel bolts on the ratchet wrench **B**.

IMPORTANT The ratchet wrench must be used on one side to unscrew and on the other side to screw.

12) Loosen the wheel bolts by about one turn, then rock the car to make it easier to remove the rim from the wheel hub.

13) Position the jack under the car near the wheel to be replaced in the point shown on the panelling at approximately 20 cm from the fender edge, as shown in (fig. 12).



Warn anyone nearby that the car is about to be lifted. They must stay clear and not touch the car until it is back on the ground.



fig. 11

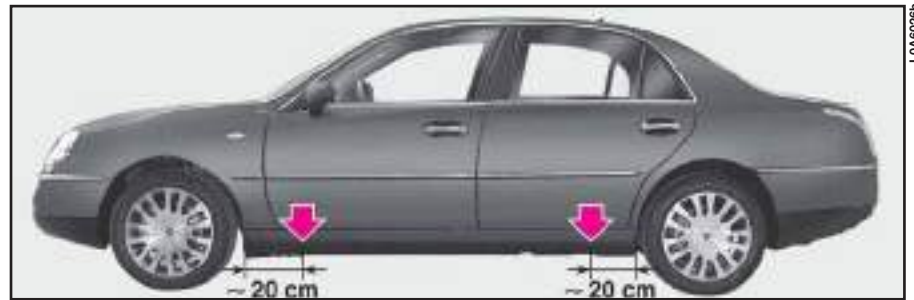

fig. 12

14) Turn the jack handle **A** (fig. 13) by hand so to open it partially and position the jack under the car.

Turn the jack handle until the jack groove **B** fits onto the bottom edge **C** of the underbody correctly.

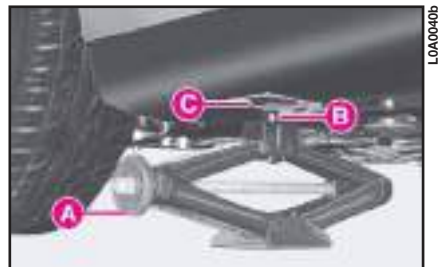

fig. 13

15) Insert the ratchet wrench **A** (fig. 14) with the bolt bush **B** on the jack groove.

IMPORTANT The ratchet wrench must be used on one side to unscrew and on the other side to screw.

16) Turn the jack handle and lift the car until the tyre is a few centimetres off the ground.

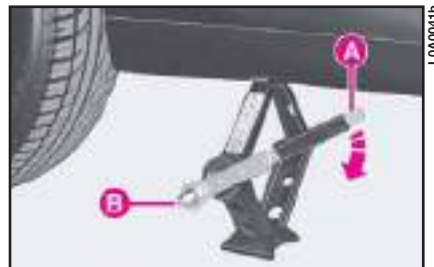

fig. 14

17) Loosen the wheel bolts and remove the wheel.

IMPORTANT To make this operation easier, use the proper bolt bush **A** (fig. 15).

18) Make sure the surfaces of the spare wheel that come into contact with the hub are clean and free from any impurities which could result in the wheel bolts working loose.



fig. 15

19) On versions with alloy rims, to make the wheel fitting easier, screw the pin **A** (fig. 16), provided in the tool kit, to the hub and then place the wheel and tighten up the four bolts in the free holes. Finally, unscrew pin **A** and screw the last bolt.

On versions with steel rims, fit the wheel making pin **A** (fig. 17) coincide with one of the holes **B**.

IMPORTANT To make bolt tightening easier, use the proper bolt bush **A** (fig. 15).



Wheel bolts are specific for the type of rim (alloy or steel) fitted. Never use, also if in an emergency, wheel bolts for another type of rim. When changing rims (alloy rims instead of steel ones or vice versa), also the whole wheel bolt set shall be changed with other bolts specific for the new type of rim adopted.

20) Lower the car and remove the jack (fig. 18).

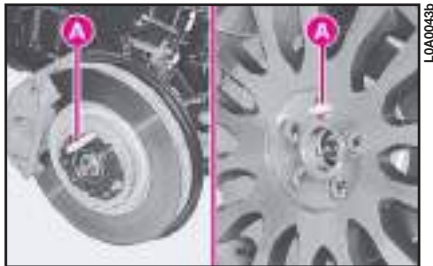

fig. 16



fig. 17

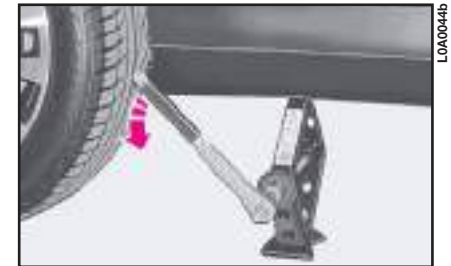

fig. 18

21) Tighten up the wheel bolts in a criss-cross fashion, following the sequence shown:

- **fig. 19** = versions with alloy rims
- **fig. 20** = versions with steel rims.

22) On versions with alloy rims, refit the wheel hub cap pressing it slightly. On versions with steel rims, approach the wheel cap making the inflating valve **A** (**fig. 21**) coincide with flaring **B**. Press the cap circumference starting near the inflating valve and proceeding until fitting the cap completely.

IMPORTANT The wheel hub cap (alloy rims) or the wheel cap (steel rims) may fly off when the car is moving if it is not fastened correctly.

23) Place the removed wheel, the jack and the tools in the boot and fasten appropriately.

IMPORTANT Put the jack back into **B** (**fig. 8**) and clamp it by screwing handle **A** (**fig. 8**) manually in order to prevent vibrations during travelling.



Bolt tightening torque must be 98 Nm (10 kgm).

After replacing the wheel, you are advised to have the wheel bolt tightening checked at a Lancia Dealership as soon as possible.

Insufficient tightening could actually make the wheel bolts loosen too much, with clearly dangerous consequences. If the bolts are tightened too much, they could be damaged and their resistance might be compromised.



fig. 19



fig. 20



fig. 21

IF A BULB BURNS OUT



Modifications or repairs to the electrical system carried out incorrectly and without bearing the features of the system in mind can cause malfunctions with the risk of fire.



The bulbs of (bi-Xeno) gas-discharge headlights must be replaced by a Lancia Dealership.



You should, where possible, have your bulbs changed at a Lancia Dealership. The correct operation and slant of headlights is essential for safe driving and compliance with legal requirements.



Only touch the metal part when handling halogen bulbs. You will reduce the light intensity and possibly compromise bulb life by touching the glass bulb. If you touch the bulb accidentally, rub it with a cloth moistened with alcohol and leave it to dry.



Halogen bulbs contain pressurised gas which, if broken, may cause small fragments of glass to be projected outwards.



Due to high voltage, the bulb of bi-Xeno gas-discharge headlights must only be replaced by experts: danger of death! Contact the Lancia Dealership.

GENERAL INSTRUCTIONS

– When a light is not working, check that it has not fused before changing the bulb.

– For the location of the fuses, refer to “If a fuse blows” in this chapter.

– Before replacing a bulb that does not work, check that the contacts are not oxidised.

– Burnt-out bulbs must be replaced with ones of the same type and power.

– Always check the slant of the headlight beam after changing a bulb for safety reasons.

TYPES OF BULBS

Different types of bulbs are installed in the car (**fig. 22**):

A - All glass bulbs

Snapped into position. Pull to remove.

B - Bayonet connection bulbs

Remove from the bulb holder by pressing the bulb and rotating it anticlockwise.

C - Cylindrical bulbs

Remove by pulling away from terminals.

D - E Halogen bulbs

To remove the bulb, release the clip holding the bulb in place.

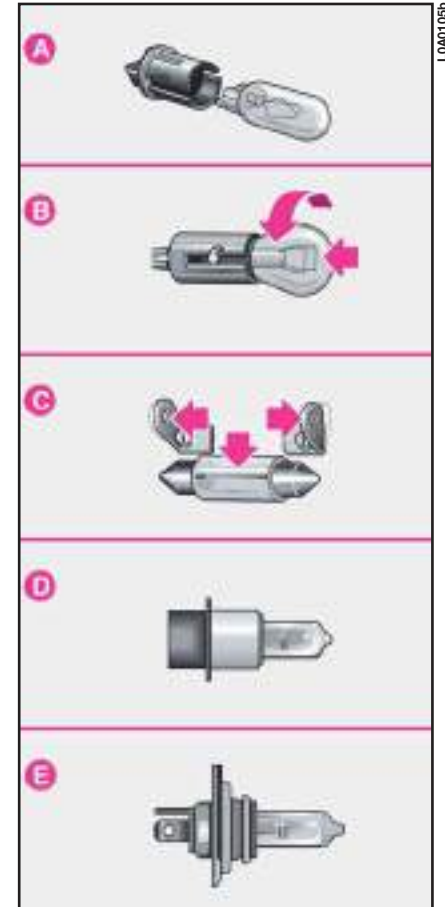

fig. 22

| Bulb | Ref. figure 22 | Type | Power |
|---|-----------------------|---------------|--------------|
| Main beam headlights/Dipped beam headlights | – | Gas-discharge | 35W |
| Additional main beam headlights | E | H7 | 55W |
| Front sidelights | B | H6W | 6W |
| Front direction indicators | B | H21W | 21W |
| Side direction indicators | A | WY5W | 5W |
| Rear direction indicators | – | LED | – |
| Front fog lights | E | H3 | 55W |
| Taillights | – | LED | – |
| Brake lights | – | LED | – |
| Third brake light | – | LED | – |
| Reversing light | B | P21W | 21W |
| Rear fog lights | B | P21W | 21W |
| Number plate light | C | C5W | 5W |
| Front ceiling light | A | Halogen | 10W |
| Courtesy lights | A | Halogen | 5W |
| Rear ceiling light | A | Halogen | 5W |
| Courtesy mirrors | C | C5W | 5W |
| Glove compartment | A | W5W | 5W |
| Boot | A | Halogen | 10W |
| Doors | A | W5W | 5W |

IF AN EXTERIOR BULB BURNS OUT

FRONT LIGHT CLUSTER

The front light cluster includes main beam headlights/dipped beam headlights, additional main beam headlights, direction indicators and sidelights.

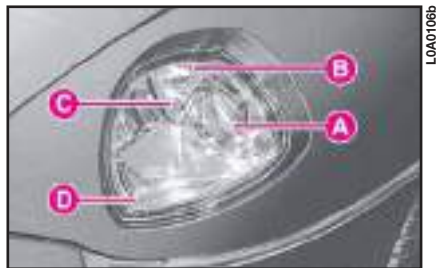

fig. 23

Light layout is the following (fig. 23):

A – Main beam headlight/dipped beam headlight (bi-Xeno bulb)

B – Sidelight

C – Additional main beam headlight

D – Direction indicator.



Due to high voltage, the bulb of bi-Xeno gas-discharge headlights must only be replaced by experts: danger of death! Contact the Lancia Dealership.



Any operation on the front light cluster must be made with the stalk at 0 (lights off) and ignition key removed for at least 15 minutes (to let bulb cooling and condensers discharging): risk of electrical discharge!



To replace front headlight bulbs, front light clusters shall be removed. It is therefore recommended to the bulbs replaced at Lancia Dealership.

FRONT FOG LIGHTS (where provided) (fig. 24)

To replace front fog lights it is necessary to operate under the vehicle, after removing the protective cover under the engine. For this reason, it is suggested to have the bulbs replaced at a **Lancia Dealership**.



fig. 24



If the front fog lights are not adjusted properly, they could annoy other drivers. Contact a Lancia Dealership for a check and any required adjustments.

SIDE DIRECTION INDICATORS (fig. 25)

To replace the bulb:

- 1) Push the lens in direction **1**, press tab **A** and remove the cluster from the back **2**.
- 2) Turn the direction indicator anticlockwise and remove the bulb holder **B**.
- 3) Remove bulb **C** and replace it.
- 4) Refit the direction indicator in the bulb holder turning it clockwise.
- 5) Refit the direction indicator on the fender first inserting the front part and then pressing the rear part until it fits.



fig. 25

REAR LIGHT CLUSTER (fig. 26)

Taillights, direction indicators and brake lights consists of leds built-into the rear light cluster.

If the lights break down partially or completely go to a **Lancia Dealership**.



fig. 26

REVERSING LIGHT AND REAR FOG LIGHTS

Reversing lights and rear fog lights are housed in the tailgate.

To replace the bulbs:

1) Open the tailgate and lift the covering **A** (fig. 27) near the bulb to be replaced.

2) Loosen the screw **B** and remove the bulb holder **C**.



fig. 27

3) Remove the clipped in glass bulbs (fig. 28).

D - B type, 12V-P21W bulb for reversing light.

E - B type, 12V-P21W bulb for rear fog light.

4) After replacing the bulbs, refit the bulb holder and fasten it with the screw.

5) Lower the tailgate cover.

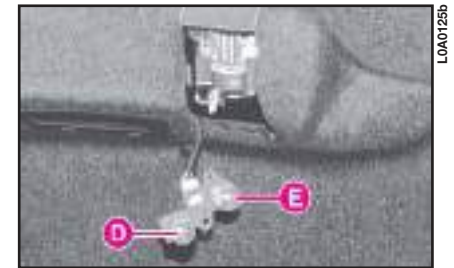

fig. 28

NUMBER PLATE LIGHTS (fig. 29)

To replace the bulb:

- 1) Remove the lens using a screwdriver as a lever in point **A**.
- 2) Remove the bulb **B** by releasing the side contacts and then replace it.
- 3) Refit the lens by inserting it first from side **C** and then by pressing it on the other side until it fits.

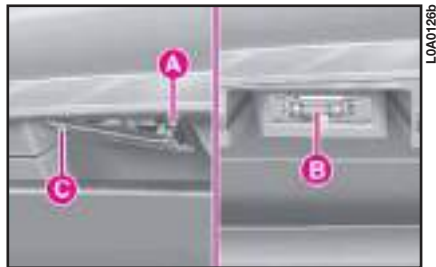

fig. 29

ADDITIONAL BRAKE LIGHT (THIRD BRAKE LIGHT) (fig. 30)

If the third brake light breaks down partially or completely go to a **Lancia Dealership**.



fig. 30

IF AN INTERIOR BULB BURNS OUT

FRONT CEILING LIGHT

To replace the bulbs:

- 1) Remove the clipped in caps **A** and **B** (fig. 31) by levering with a screwdriver on the external part.



fig. 31

2) Loosen the screws **C** (**fig. 32**) and remove the ceiling light.

3) To remove bulb holders turn them anticlockwise (**fig. 33**).

D - Central ceiling light bulb.

E - Courtesy light bulbs.

4) Remove the clipped in glass bulbs from the bulb holder and replace them.

5) Insert the bulb holders and turn them clockwise.

6) Refit the ceiling light and secure it with the screws.

7) Refit the clipped in caps.

IMPORTANT When refitting the ceiling light check that the electrical wires are positioned correctly.

REAR CEILING LIGHT

To replace the bulbs:

1) Remove the ceiling light by levering with a screwdriver on the front edge (**fig. 34**).

2) To remove bulb holders turn them anticlockwise (**fig. 35**).



fig. 32

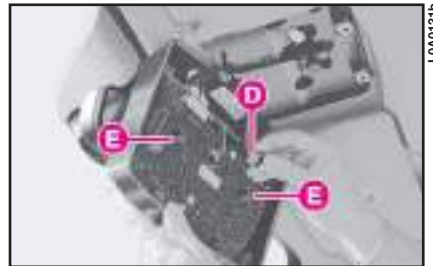

fig. 33



fig. 34

A - Central ceiling light bulb.

B - Courtesy light bulbs.

3) Remove clipped in glass bulbs from the bulb holders and replace them.

4) Insert the bulb holders and turn them clockwise.

5) Refit the ceiling light by inserting first the rear part and then pressing the front part until it fits.

IMPORTANT When refitting the ceiling light check that the electrical wires are positioned correctly.

GLOVE COMPARTMENT LIGHT

To replace the bulb:

1) Remove the lens by using a screwdriver as a lever on clip **A** (fig. 36).

2) Press the two sides of shield **B** (fig. 37) at the fastening clips and turn it.

3) Replace the clipped in bulb **C**.

4) Close the shield **B** by clipping it into its housing.

5) Refit the lens by inserting side **D** (fig. 36) first and then pressing the other side to engage clip **A**.

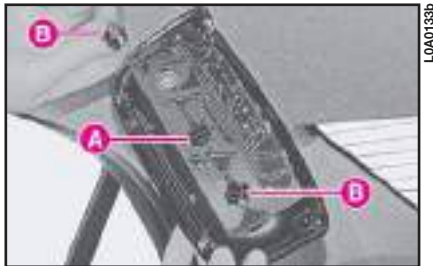

fig. 35

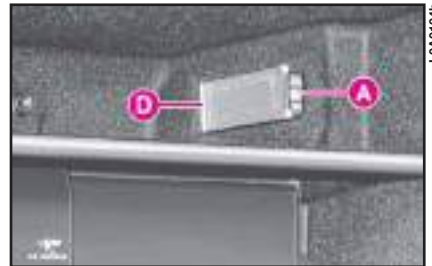

fig. 36



fig. 37

COURTESY MIRROR LIGHTS

To replace the courtesy mirror bulbs:

- 1) Lift the mirror cover **A** (**fig. 38**).
- 2) Remove the mirror by levering in **B**.

IMPORTANT Be very careful when removing the mirror to avoid damaging its frame and the mirror itself.

3) Remove the bulbs **C** (**fig. 39**) releasing them from the side contacts and replace them.

4) Refit the mirror inserting first the upper edge and then pressing the lower edge until it fits.

BOOT LIGHT

To replace the bulb:

1) Remove the lens by using a screwdriver as a lever on clip **A** (**fig. 40**).

2) Press the two sides of shield **B** (**fig. 41**) at the fastening clips and remove it.

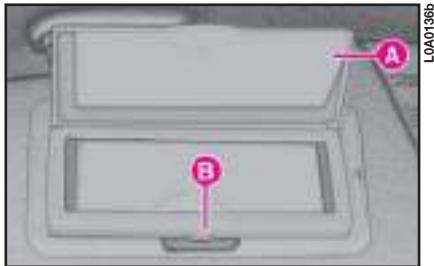

fig. 38



fig. 39

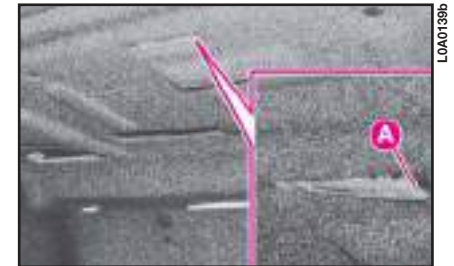

fig. 40

- 3) Replace the clipped in bulb **C** .
- 4) Close the shield by clipping it into its housing.
- 5) Refit the lens by inserting side **D** first and then pressing the other side to engage clip **A**.

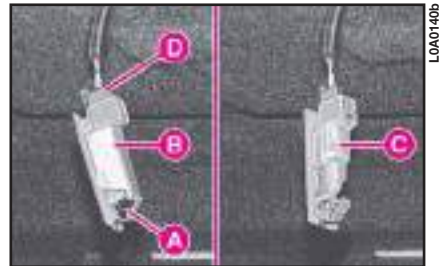

fig. 41

DOOR LIGHTS (fig. 42)

To replace the bulb:

- 1) Remove the lens by using a screwdriver as a lever on clip **A**.
- 2) Press the two sides of shield **B** at the fastening clips and turn it.
- 3) Replace the clipped in bulb **C**.
- 4) Close the shield **B** by clipping it into its housing.
- 5) Refit the lens by inserting side **D** first and then pressing the other side to engage clip **A**.

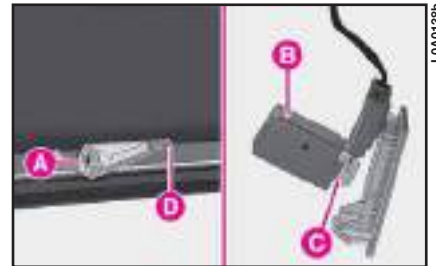

fig. 42

DOOR MIRROR LIGHTS (fig. 43)

To replace the bulb:

- 1) Remove the lens by using a screwdriver as a lever on clip **A**.
- 2) Remove the bulb holder **B** by turning it anticlockwise.
- 3) Replace the clipped in bulb **C**.
- 4) Insert the bulb holder and turn it clockwise.
- 5) Refit the lens by inserting side **D** first and then pressing the other side to fit it.



fig. 43

IF A FUSE BLOWS

GENERAL (fig. 67)

The fuse is a protective device for the electric system. It comes into action (i.e. it cuts off) in the event of a failure or improper actions on the electric system.

If an electrical device is not working, check whether the respective fuse is blown. The conductor should not be broken. If it is, replace it with another with the same amperage (same colour).

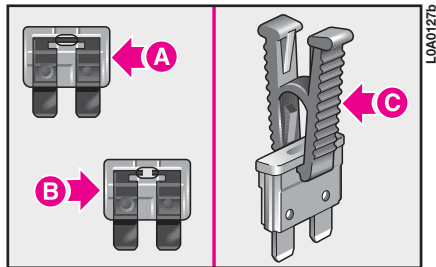

fig. 67

A - Undamaged fuse

B - Fuse with broken filament.

Use the tongs C to extract a fuse to be replaced. The tongs are to be found in the main fuse box.



Never replace a fuse with metal wires or anything else. Always use an intact fuse of the same colour (same value).



Never change a fuse with another of higher amperage: FIRE RISK!



If a general fuse (MIDI-FUSE or MEGA-FUSE) blows, do not repair it, but go to a Lancia Dealership.



Before changing a fuse, check the ignition key has been removed and that all the other electrical devices have been switched off.



If the fuse blows again, have the car inspected at a Lancia Dealership.

FUSE LOCATION

The main fuses of THESIS are contained into four fuse boxes, to be found on the left side of the dashboard, in the engine compartment, on the battery and in the right side compartment of the boot.

GENERAL FUSES

(MIDI-FUSE and MEGA-FUSE)

The car is fitted with a set of general fuses (MIDI-FUSE and MEGA-FUSE) which separately protect the various electrical system functions in addition to the individual device fuses.

The general fuses are located in the left side of the boot in a fusebox directly connected to the positive battery terminal.

To reach the fuses:

- 1) Open the tailgate.
- 2) Loosen knob **A** (fig. 68) and remove the battery cover **B**.
- 3) Press tabs **A** (fig. 69) and remove the cover **B**.

The systems and devices protected by the general fuses (fig. 70) are listed on the following pages.

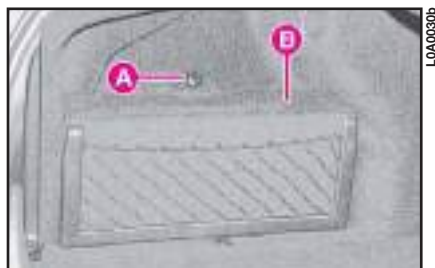

fig. 68

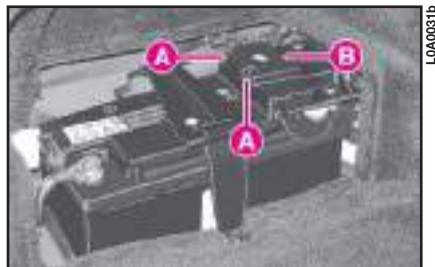

fig. 69



fig. 70

FUSES IN THE DASHBOARD

The fuses protecting the main devices are arranged in a fusebox located under the dashboard, on the left of the steering column, behind the glove compartment (fig. 72).

To reach the fuses open the glove compartment **A** (fig. 71) and then remove it by loosening the two screws **B** with a screwdriver. After replacing the fuses, refit the glove compartment and secure it by the two screws.

The fusebox also contains tongs for removing the fuses.

Spare fuses **A** (fig. 72) are housed in horizontal position in the upper part of the fusebox. The spare fuse present various amperages.

The devices protected by the fuses (fig. 73) are listed in the tables on the following pages.

IMPORTANT Remember to replace the spare fuse after replacing a fuse.

FUSES IN THE ENGINE COMPARTMENT

The fusebox is located on the left side of the engine compartment.

To reach the fuses remove the cover **A** (fig. 74) after releasing the fastening clips **B**.

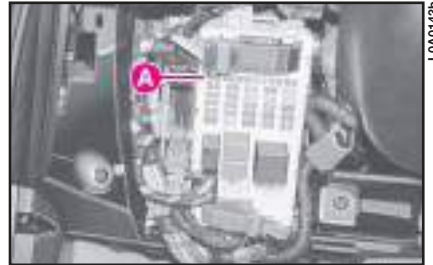

fig. 72

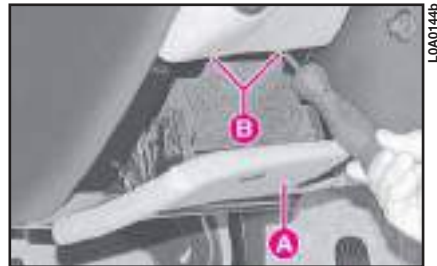

fig. 71

| | | | | |
|----|----|----|----|----|
| | | | | |
| 1 | 2 | 3 | 4 | 5 |
| 6 | 7 | 8 | 9 | 10 |
| 11 | 12 | 13 | 14 | 15 |
| 16 | 17 | 18 | 19 | 20 |
| 21 | 22 | 23 | 24 | 25 |

fig. 73

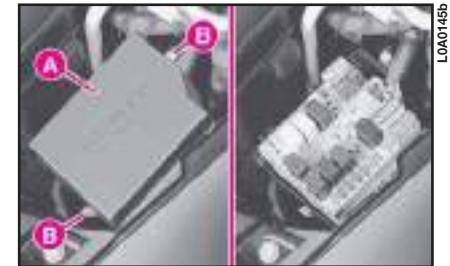

fig. 74

The devices protected by the fuses (fig. 75) are listed in the tables on the following pages.

After replacing the fuses refit the cover by refitting the fastening clips.

FUSES IN THE BOOT

The fusebox (fig. 77) is located on the right side of the boot, inside the service compartment.

To open the compartment flap turn the catch A (fig. 76) to 1 with the ignition key and lower it.

The spare fuses, with different amperage, are housed in vertical position at the sides of the fusebox.

The devices protected by the fuses (fig. 78) are listed in the tables on the following pages.

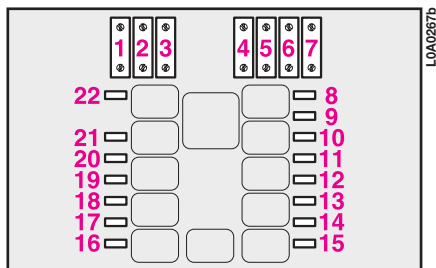

fig. 75



fig. 76



fig. 77

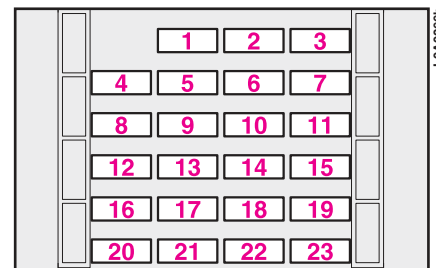

fig. 78

| MIDI-FUSE and MEGA-FUSE | Fuse | Ampere | Location |
|--------------------------------|-------------|---------------|-----------------|
| Dashboard fusebox 1 | 1 | 70 | fig. 70 |
| Dashboard fusebox 2 | 2 | 50 | fig. 70 |
| Boot fusebox | 3 | 60 | fig. 70 |
| Engine compartment fusebox | 4 | 150 | fig. 70 |

| Exterior lights | Fuse | Ampere | Location |
|---|-------------|---------------|-----------------|
| External light control (twilight sensor adjustment) | 23 | 7.5 | fig. 73 |
| Direction indicators | 16 | 10 | fig. 73 |
| Right-hand main beam headlight | 8 | 10 | fig. 75 |
| Left-hand main beam headlight | 10 | 10 | fig. 75 |
| Right-hand dipped beam headlight | 24 | 15 | fig. 73 |
| Left-hand dipped beam headlight | 25 | 15 | fig. 73 |
| Reversing light | 21 | 7.5 | fig. 73 |
| Third brake light | 14 | 10 | fig. 73 |
| Hazard lights | 16 | 10 | fig. 73 |
| Front fog lights | 14 | 15 | fig. 75 |

| Interior lights | Fuse | Ampere | Location |
|--|-------------|---------------|-----------------|
| Boot ceiling light | 19 (*) | 10 | fig. 78 |
| | 13 (*) | 10 | fig. 73 |
| Passenger compartment rear ceiling light | 19 (*) | 10 | fig. 78 |
| | 13 (*) | 10 | fig. 73 |
| Door puddle lights | 19 (*) | 10 | fig. 78 |
| | 13 (*) | 10 | fig. 73 |

(*) As an alternative for certain versions/markets

| Devices and utilities | Fuse | Ampere | Location |
|--|----------------------|---------------|-----------------|
| Available | 1-6-8-12-17-18-21-23 | – | fig. 78 |
| Cigar lighter | 22 | 20 | fig. 73 |
| Air bag | 18 | 7.5 | fig. 73 |
| Power supply point boot 1 | 9 | 20 | fig. 73 |
| Power supply point boot 2 | 5 | 20 | fig. 73 |
| Amplifier for sound system with HI-FI system | 7 | 25 | fig. 78 |
| Rear head restraints (tilting) | 3 | 25 | fig. 73 |
| Boot (electrified lock actuator) | 11 | 20 | fig. 78 |
| Spark plugs (petrol versions) | 19 | 15 | fig. 75 |
| Engine compartment relay coils | 21 | 7.5 | fig. 73 |
| Headlight beam adjustment control unit | 14 | 10 | fig. 73 |
| | 25 | 15 | fig. 73 |
| Trailer control unit (presetting) | 1 | 10 | fig. 73 |
| Power steering control unit | 15 | 7.5 | fig. 73 |

| Devices and utilities | Fuse | Ampere | Location |
|--|-------------|---------------|-----------------|
| Horn | 11 | 15 | fig. 75 |
| Windscreen wiper controls | 23 | 7.5 | fig. 73 |
| Brake light control (NC) | 20 | 7.5 | fig. 73 |
| Brake light control (NA) | 14 | 10 | fig. 73 |
| Ignition switch | 7 | 20 | fig. 75 |
| Air conditioner compressor | 12 | 7.5 | fig. 75 |
| Cruise Control (satellite controls) | 20 | 7.5 | fig. 73 |
| Cruise Control (Adaptive point) | 20 | 7.5 | fig. 73 |
| Climate control system fan | 5 | 40 | fig. 75 |
| Engine cooling electric fan (first) | 3 | 60 | fig. 75 |
| Engine cooling electric fan (second) | 4 | 20 | fig. 78 |
| Right-hand headlight (control unit) | 10 | 7.5 | fig. 78 |
| Left-hand headlight (control unit) | 10 | 7.5 | fig. 78 |
| Diesel fuel filter (PTC) | 16 | 20 | fig. 75 |
| Electronic injection system | 13 | 7.5 | fig. 75 |
| Injectors (diesel versions) | 19 | 20 | fig. 75 |
| Driving position point interface | 14 | 20 | fig. 78 |
| Automatic transmission point interface | 15 | 10 | fig. 78 |
| | 23 | 7.5 | fig. 73 |
| Climate control system point interface | 6 | 10 | fig. 73 |
| | 15 | 7.5 | fig. 73 |

| Devices and utilities | Fuse | Ampere | Location |
|--|-------------|---------------|-----------------|
| Engine control system point interface | 22 | 7.5 | fig. 75 |
| Brake system point interface | 29 | 7.5 | fig. 73 |
| Headlight washers | 15 | 20 | fig. 75 |
| Heated rear window | 17 | 30 | fig. 73 |
| Automatic gearbox starter | 17 | 30 | fig. 75 |
| NIM | 6 | 10 | fig. 73 |
| Passenger position point | 14 | 10 | fig. 78 |
| Steering lock point | 22 | 10 | fig. 78 |
| Brake Assistant point | 19 (*) | 10 | fig. 78 |
| (*) As an alternative for certain versions/markets | 13 (*) | 10 | fig. 73 |
| | 19 | 7.5 | fig. 73 |
| Braking system point (NFR 1) | 1 | 40 | fig. 75 |
| Braking system point (NFR 2) | 6 | 40 | fig. 75 |
| Infotelematic point | 6 | 10 | fig. 73 |
| Yaw Lateral point | 19 (*) | 10 | fig. 78 |
| (*) As an alternative for certain versions/markets | 13 (*) | 10 | fig. 73 |
| | 19 | 7.5 | fig. 73 |
| Keyless System point | 22 | 10 | fig. 78 |
| Driver door point | 11 | 20 | fig. 78 |
| Driver door point (power supply) | 8 | 20 | fig. 73 |
| Passenger door point | 11 | 20 | fig. 78 |
| | 23 | 7.5 | fig. 73 |

| Devices and utilities | Fuse | Ampere | Location |
|--|-------------|---------------|-----------------|
| Passenger door point (power supply) | 10 | 20 | fig. 73 |
| Instrument panel point | 14 | 10 | fig. 73 |
| | 16 | 10 | fig. 73 |
| Steering angle sensor point (*) As an alternative for certain versions/markets | 19 (*) | 10 | fig. 78 |
| | 13 (*) | 10 | fig. 73 |
| | 19 | 7.5 | fig. 73 |
| Parking sensor point | 15 | 7.5 | fig. 73 |
| TV tuner point | 14 | 10 | fig. 78 |
| | 15 | 7.5 | fig. 73 |
| Boot point | 11 | 20 | fig. 78 |
| Steering wheel point | 15 | 7.5 | fig. 73 |
| Central console control panels | 15 | 7.5 | fig. 73 |
| Fuel pump | 21 | 15 | fig. 75 |
| Doors (electrified lock actuators) | 11 | 20 | fig. 78 |
| Spark plug pre-heating | 2 | 60 | fig. 75 |
| EOBD system diagnostic socket | 6 | 10 | fig. 73 |
| Current socket in boot | 22 | 20 | fig. 73 |
| Current socket in rear armrest | 13 | 20 | fig. 78 |
| | 2 | 15 | fig. 73 |
| Parking heater (control unit) | 3 | 20 | fig. 78 |
| Additional heater | 4 | 50 | fig. 75 |
| | 9 | 20 | fig. 75 |

| Devices and utilities | Fuse | Ampere | Location |
|---|-------------|---------------|-----------------|
| Heated windscreen defroster | 7 | 15 | fig. 73 |
| Windscreen wiper nozzle defroster | 7 | 15 | fig. 73 |
| SCS | 15 | 7.5 | fig. 73 |
| Comfort driver's seat | 5 | 30 | fig. 78 |
| Comfort front passenger's seat | 9 | 30 | fig. 78 |
| Electric driver's seat (movement) | 5 | 30 | fig. 78 |
| Electric front passenger's seat (movement) | 9 | 30 | fig. 78 |
| Front seats (heating) | 16 | 20 | fig. 78 |
| Rear seats (heating) | 20 | 20 | fig. 78 |
| Primary services for electronic injection | 20 | 15 | fig. 75 |
| Secondary services for electronic injection | 18 | 15 | fig. 75 |
| Alarm siren (control unit) | 6 | 10 | fig. 73 |
| Fuel flap (locking/unlocking ratiomotor) | 11 | 10 | fig. 73 |
| Rear window sun visor | 4 | 15 | fig. 73 |
| Windscreen wiper and washer | 12 | 30 | fig. 73 |
| Sunroof (control unit) | 4 | 15 | fig. 73 |
| | 2 | 20 | fig. 78 |
| Steering wheel (steering column adjustment) | 15 | 7.5 | fig. 73 |

IF BATTERY IS TO BE DISCONNECTED

Battery is housed on the left side of the luggage compartment, protected by cover **B** (fig. 79). To remove cover unscrew knob **A**.

DISCONNECTING THE LOADED BATTERY

Should the charged battery be disconnected (e.g. during a car inactivity time) perform these operations in the given order:

1) Depress the push button on the central console or on the remote control to open the boot.

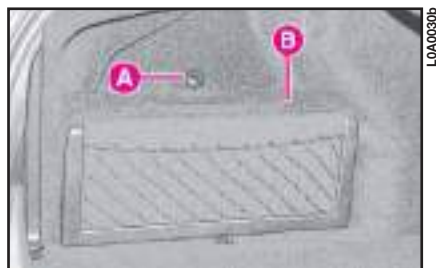

fig. 79



fig. 80



fig. 81

2) Depress manually the inside hook **A** (fig. 80) of the boot lock, and push it back completely until the recall electric travel is activated.

3) Remove the cover and disconnect battery terminals.

4) Fully turn anti-clockwise the key into the outside bonnet lock to pull out the locking hook (fig. 81).

5) If necessary, it is now possible to fully close the boot, leaving the battery disconnected.

6) When the battery is to be connected again, to open the bonnet, fully

turn the key anticlockwise in the lock, and at the same time slightly press the lower edge of the number plate holder to reduce operation effort (fig. 81).

7) Connect battery terminals and assemble the cover again.

8) Depress push button **A** (fig. 81) to restore normal lock operation.

9) Normally close the boot without slamming it down; the lock electric servo control will fully lock it.

10) Perform the initialisation of the door lock, air conditioner and ESP system control units, described below.

DISCONNECTING THE UNLOADED BATTERY

Should the discharged battery be disconnected (to have it charged again or to replace it) perform the following operations in the given order:

- 1) To open the boot from the outside, fully turn the key anticlockwise in the lock (**fig. 81**), and at the same time slightly press the lower edge of the number plate holder to reduce operation effort.
- 2) Remove the cover and disconnect the battery terminals.
- 3) Fully charge the battery again or replace it.



It is not possible to close the boot when battery is discharged or disconnected for the purpose of being replaced/ charged again: do not try to close the boot by slamming it down. The boot remains anyhow hooked on and it must be re-opened by turning the key in the lock.

- 4) Connect battery terminals and re-assemble cover.
- 5) Depress push button A (**fig. 81**) to restore normal lock operation.
- 6) Close boot normally without slamming it down: lock electric servo control will fully lock it.
- 7) Perform the initialisation procedure of the door lock, air conditioner and ESP system control units, hereafter described.

INITIALISING THE CONTROL UNITS OF THE DOOR LOCKS, AIR CONDITIONER AND ESP SYSTEM

Whenever the battery is connected electrically or protection fuses are replaced, to restore correct door locking, air conditioning and ESP system, perform the following operations (after connection is performed or after replacing one of the fuses):

- 1) Enter key into the lock of one of the front doors and perform a door centralised opening/closing cycle.
- 2) Start the engine and turn on the compressor of the conditioner, setting a lower temperature value than that of the environment and check whether the led on the disconnection push button of the conditioner compressor ✱ is lit.
- 3) Start running the car and drive it for a few meters in a straight line (accelerating), until the ESP warning light is off (⚠).

IF THE BATTERY IS FLAT

First of all, read the “Car maintenance” chapter for the steps to be taken to avoid the battery running down and to ensure it has a long life.

RECHARGING THE BATTERY

IMPORTANT The description of the battery recharging procedure is just for information. To carry out this procedure go to a **Lancia Dealership**.

You are advised to recharge the battery slowly for a period of approximately 24 hours at a low amperage. Charging for too long could damage the battery.



Before reloading, carefully read and comply with the instructions contained in the previous paragraph “If battery is to be disconnected”.

Proceed as follows:

- Disconnect the terminal from the battery negative pole (-).
- Connect the charger cables to the battery terminals (observe polarity).
- Turn on the charger.
- When you have finished, turn the charger off before disconnecting the battery.
- Reconnect the terminal to the battery negative pole (-).



The liquid in the battery is poisonous and corrosive. Do not let it touch the skin or eyes. Recharging the battery should be done in a well-ventilated area and away from naked flames or possible sources of sparks: explosion and fire risk.

JUMP STARTING

See “Jump starting” in this chapter.



Never try to charge a frozen battery: first let it thaw out, otherwise it may bust. If the battery has frozen, check that the internal elements are not broken (risk of short circuit) and that the casing is not cracked causing the acid to leak out. This acid is poisonous and corrosive.



Under no circumstances should a battery charger be used to start the engine: it could damage the electronic systems and in particular the ignition and injection control units.

TOWING THE CAR

The tow ring provided with the car is to be found in the tool box under the boot carpet.

To fit the tow ring proceed as follows:

– Remove the clipped in **A** cover from the front (fig. 82) or rear bumper (fig. 83), by using a screwdriver as a lever in the point shown in the figure.

IMPORTANT To carry out this operation, if you use the provided flat-head screwdriver, cover its head with a piece of cloth to prevent paint damaging.

– Screw the tow ring **B** in its housing.



Carefully clean the threading before fastening the tow ring. Before starting to tow the car, make sure the ring has been fully fastened.



fig. 82

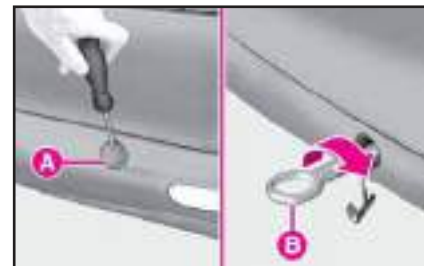

fig. 83



Before starting to tow, turn the ignition key to **MAR** and then to **STOP**. Do not remove the key. If the key is removed, the steering lock engages automatically which prevents the wheels being turned. Disengage the handbrake. While the car is being towed with the engine off, remember that the brake pedal and steering will require more effort as you no longer have the benefit of the brake booster and power steering. Do not use flexible cables to tow. Avoid jerking. Whilst towing, ensure that the coupling to the car does not damage the surrounding components. When towing, you must comply with the specific traffic regulations regarding the tow ring and how to tow on the road.



Before towing the car, disengage the parking brake by following the instructions described in the relevant paragraph, and leave the Keyless System CID device (if provided) inside the passenger compartment, to avoid automatic steering column lock. Do not tow the car with the engine running.

IMPORTANT For versions with automatic gearbox, check that the selector is in neutral (selector to **N**), that the car is moving because pushed and act as for towing a car with the manual gearbox, following the above mentioned procedure.

If you cannot set the gear lever to neutral, do not tow the car but contact a **Lancia Dealership**.

IMPORTANT On versions fitted with an identification system (Keyless System), user is not authorised to move the car unless the start-up knob is turned to the position **MAR**. Should it be necessary to tow the car, it is advised to turn the knob to position **MAR** before moving the car.

JACKING THE CAR

WITH THE JACK

See “If a tyre is punctured”, in this chapter.

Please note:

- the jack weighs 2.100 kg;
- the jack requires no adjustments;
- the jack cannot be repaired. If it breaks, it must be replaced with a new jack.



The jack should only be used to change a wheel on the car for which it was designed. It should not be put to other uses or employed to raise other models. Under no circumstances should it be used when carrying out repairs under the car.



An incorrectly positioned jack may cause the car to fall. Do not use the jack to lift loads exceeding those indicated on the label attached to the jack itself.

WITH AN ARM HOIST OR A SHOP JACK

The car can only be jacked up by positioning the jack arms or the shop jack in the areas shown in **fig. 84**.



Be very careful not to squeeze the brake pipes, the fuel pipes or the side member ribbing.



fig. 84

LOA80268

IF AN ACCIDENT OCCURS

- It is important to keep calm.
- If you are not directly involved in the accident, stop at least ten metres away from the accident.
- If you are on a motorway do not obstruct the emergency lane with your car.
- Turn off the engine and turn on the hazard lights.
- At night, illuminate the scene of the accident with your headlights.
- Act carefully, you must not risk being run over.
- Mark the accident by putting the red triangle at the regulatory distance from the car where it can be clearly seen.
- Call for rescue making the information you give as accurate as you can. On the motorway use the special column-mounted emergency phones.

– In pile-ups on the motorway, particularly when the visibility is bad, there is a high risk of other vehicles running into those already stopped. Get out of the car immediately and take refuge behind the guard rail.

– If the doors are blocked, do not attempt to smash the windscreen to get out of the car. It is made of layered glass and is very hard. Side and rear window are much more easily broken.

– Remove the ignition keys from the vehicles involved.

– If you can smell petrol or other chemicals, do not smoke and make sure all cigarettes are extinguished.

– Use a fire extinguisher, blanket, sand or earth to put out fires no matter how small they are. Never use water.

– If it is not necessary to use the car light system, disconnect the negative terminal (-) from the battery pole.

IF ANYONE IS INJURED

Never leave the injured person alone. The obligation to provide assistance exists even for those not directly involved in the accident

– Do not congregate around the injured person

– Reassure the injured person that help is on its way and will arrive soon. Stay close by to calm him/her down in case of panic

– Unfasten or cut seat belts holding injured parties

– Do not give an injured person anything to drink.

– Do not move an injured person unless the following situations arise

– Pull the injured person from the car only if it risks catching fire, it is sinking in water or is likely to fall over a cliff or similar. Do not pull his/her arms or legs, do not bend the head and, as far as possible, keep the body horizontal.

FIRST-AID KIT (fig. 85)

The first-aid kit must at least contain

- sterile gauze for covering and cleansing wounds
- bandages of different heights
- antiseptic plasters of different sizes
- a roll of plaster
- a pack of cotton wool
- a bottle of disinfectant
- a packet of paper handkerchiefs

- a pair of scissors with rounded tips
- a pair of tweezers
- two haemostatic loops

It is a good idea to keep a fire extinguisher and blanket in the car in addition to the first-aid kit.

The first-aid kit and the fire extinguisher are included in the Lineacessori Lancia range.

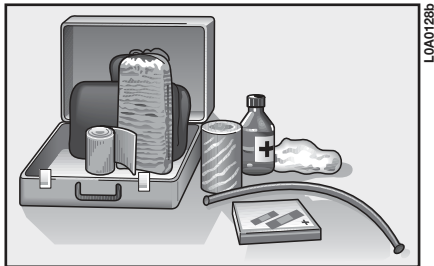

fig. 85

CAR MAINTENANCE

SCHEDULED SERVICING

Correct maintenance of the car is essential for ensuring it stays in tip-top condition for a long time to come.

This is why LANCIA has programmed a number of service operations every 20,000 kilometres:

IMPORTANT The Manufacturer requires the Service Schedule coupon related checks to be carried out. Failure to do so could result in the warranty being cancelled for those defects that can be attributed to such failure.

Scheduled Servicing is performed at all **Lancia Dealerships** and there is a set time scale for such operations.

If it is seen that further replacements or repairs are necessary in addition to the work being carried out, these will only be done after the customer has given his/her consent.

IMPORTANT You are recommended to get in touch with a **Lancia Dealership** immediately if any minor running problems crop up without waiting for the next coupon.

SERVICE SCHEDULE

| thousands of kilometres | 20 | 40 | 60 | 80 | 100 | 120 | 140 | 160 | 180 |
|---|----|----|----|----|-----|-----|-----|-----|-----|
| Check tyre conditions and wear; adjust pressure, if required | ● | ● | ● | ● | ● | ● | ● | ● | ● |
| Check primary and secondary battery charge status | ● | ● | ● | ● | ● | ● | ● | ● | ● |
| Check wear of windscreen/rear window blades | ● | ● | ● | ● | ● | ● | ● | ● | ● |
| Check rear disc brake pad wear | | ● | | ● | | ● | | ● | |
| Inspect conditions of: underbody protection and outside bodywork, piping (exhaust - fuel lines - brake lines), rubber parts (boots, sleeves, bushings, etc.), brake and fuel line hoses | ● | ● | ● | ● | ● | ● | ● | ● | ● |
| Check for bonnet and boot lock cleanness, lever cleanness and lubrication | ● | ● | ● | ● | ● | ● | ● | ● | ● |
| Sight check for conditions of Poly-V accessory drive belt | | | ● | | | | | | ● |
| Check diesel engine smokiness in exhaust | | ● | | ● | | ● | | ● | |
| Replace fuel filter (JTD versions) | ● | ● | ● | ● | ● | ● | ● | ● | ● |
| Check fuel evaporation system operation | | | | ● | | | | ● | |
| Replace air cleaner cartridge (petrol versions) | | ● | | ● | | ● | | ● | |
| Replace air cleaner cartridge (JTD versions) | ● | ● | ● | ● | ● | ● | ● | ● | ● |
| Check and top up fluids (engine coolant, brakes, hydraulic clutch, power steering, windscreen washer, battery, etc.) | ● | ● | ● | ● | ● | ● | ● | ● | ● |

| | thousands of kilometres | | | | | | | | | |
|---|-------------------------|-----|-----|-----|-----|-----|-----|-----|-----|-----|
| | 20 | 40 | 60 | 80 | 100 | 120 | 140 | 160 | 180 | |
| Inspect conditions of timing belt | | | ● | | | | | | | ● |
| Replacement of timing gear drive belt (*) and Poly-V accessory drive belt | | | | | | ● | | | | |
| Replace spark plugs (3.2 versions) | | | | | ● | | | | | |
| Replace spark plugs (2.0 TB) | | ● | | ● | | ● | | ● | | |
| Check engine control systems via diagnostic socket | | ● | | ● | | ● | | ● | | |
| Check manual gearbox oil level | | | | ● | | | | ● | | |
| Check automatic gearbox oil level | | ● | | ● | | ● | | ● | | |
| Change engine oil and oil filter (petrol versions) | ● | ● | ● | ● | ● | ● | ● | ● | ● | ● |
| Change engine oil and oil filter (2.4 JTD CAE version)(**) | (●) | (●) | (●) | (●) | (●) | (●) | (●) | (●) | (●) | (●) |
| Change brake fluid (or every 2 years) | | | ● | | | ● | | | | ● |
| Replace dust/pollen filter (or every year) | ● | ● | ● | ● | ● | ● | ● | ● | ● | ● |
| Clean engine cooling system | ● | ● | ● | ● | ● | ● | ● | ● | ● | ● |

(*) Or every 4 years, in the event of demanding use (cold climate, use in cities, long idling, dusty areas).
Or every five years, regardless of the distance travelled.

(**) Actual interval for changing engine oil and oil filter depends on the conditions of use of the car and it is indicated by the relevant message on the display (see section “Warning lights and messages”).

ANNUAL INSPECTION SCHEDULE

The following annual inspection schedule is recommended for cars travelling less than 20,000 km a year (e.g. approximately 10,000 km). The schedule includes the following operations:

- 1) Check tyre condition and wear and adjust pressure (including spare wheel)
- 2) Check wear on windscreen/rear window blades
- 3) Check rear disc brake pad conditions and wear
- 4) Inspect conditions of: underbody protection and outside bodywork, piping (exhaust - fuel lines - brake lines), rubber parts (boots - sleeves - bushings, etc.), brake and fuel line hoses

5) check for bonnet and boot lock cleanness, lever cleanness and lubrication

6) Check primary and secondary battery charge status

7) Check conditions of various control belts

8) Check and top up fluid levels (engine coolant, brakes, windscreen washer, battery, etc.)

9) Change engine oil

10) Replace engine oil filter

11) Replace dust/pollen filter.

ADDITIONAL CHECKS

Every 1,000 km or before long trips, check and top up as necessary:

- engine coolant level
- brake/hydraulic clutch fluid level
- power steering fluid level
- windscreen/rear window and headlight washer fluid level
- tyre pressure and conditions.

Every 3,000 km check the engine oil level and top up as necessary.

You are recommended to use **FL Selenia** products that are designed and produced specifically for LANCIA cars (see "Capacities" in "Technical Specifications").



Do not smoke while working in the engine compartment: the presence of flammable gas and vapour could cause a fire.



Be careful not to mix up the various types of fluids when you are topping up: they are all mutually incompatible and could damage the car.



Maintenance of your car should be entrusted to a Lancia Dealership. For ordinary routine maintenance operations which you are able to carry out yourself, ensure that you have the necessary tools and original Lancia spare parts and fluids available. Do not carry out servicing operations if you have no experience.

IMPORTANT - Engine oil

If the car is normally driven in one of the following particularly severe conditions:

- towing a trailer
- on dirty roads
- for short, repeated trips (less than 7-8 km) with outside temperature below zero
- with engine frequently idling or for long distances at low speed (e.g. taxi, door-to-door deliveries) or prolonged storage

change the engine oil more frequently than shown in the Service Schedule.

IMPORTANT - Air cleaner

Replace the air cleaner more frequently than shown in the Service Schedule if the car is used on dusty roads.

If you are in doubt about how often the engine oil or the air cleaner should be changed in relation to how you use the car, contact a **Lancia Dealership**.

IMPORTANT - Diesel filter

The different grades of purity in diesel fuel normally available might make it necessary to replace the filter more frequently than indicated in the Service Schedule. If the engine misfires it shows the filter needs changing.

IMPORTANT - Dust/pollen filter

If the car is often used in dusty or extremely polluted environments, you should change the filter element more frequently. It should be changed especially if the amount of air introduced into the passenger compartment is reduced.

IMPORTANT - Battery

The charge in your battery should be checked, where possible at the start of the winter, to limit the risk of the battery electrolyte freezing.

This check should be carried out more frequently if the car is mainly used for short trips or if it is fitted with accessories that permanently take in electricity even when the ignition key is removed, especially in the case of after market accessories.

If the car is used in very hot climates or particularly demanding conditions check the battery electrolyte more frequently than shown in the "Service Schedule" in the "Car maintenance" chapter.

CHECKING FLUID LEVELS

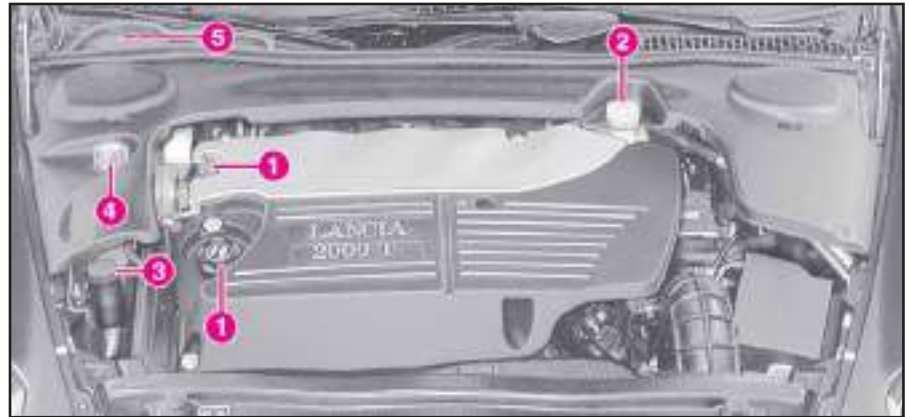

fig. 1 - 2.0 TB version

LOA0343b

- 1) Engine oil
- 2) Brake fluid
- 3) Windscreen/rear window and headlight washer fluid
- 4) Engine coolant
- 5) Power steering fluid

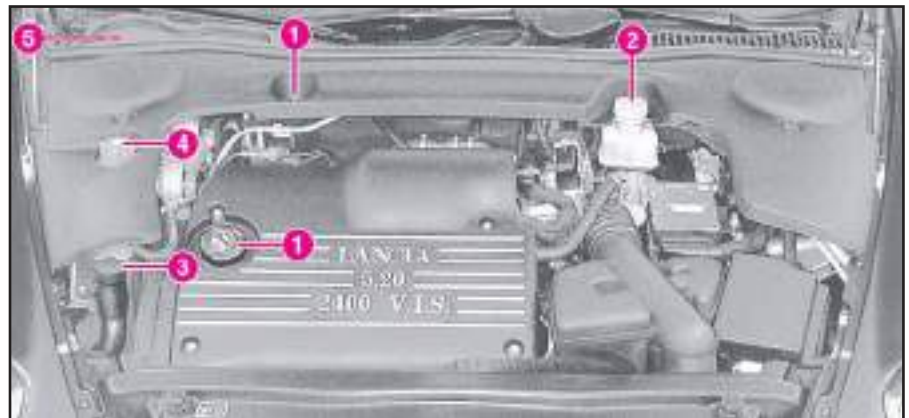

fig. 2 - 2.4 - 2.4 CAE versions

LOA0344b

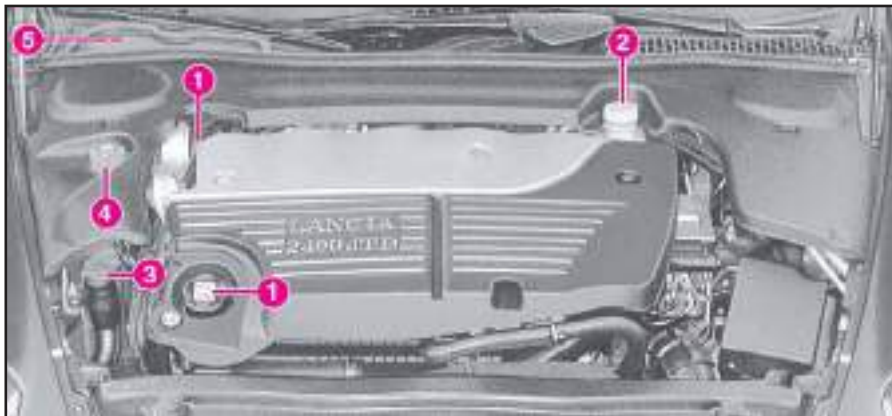

fig. 3 - 2.4 JTD version

L0A0345b

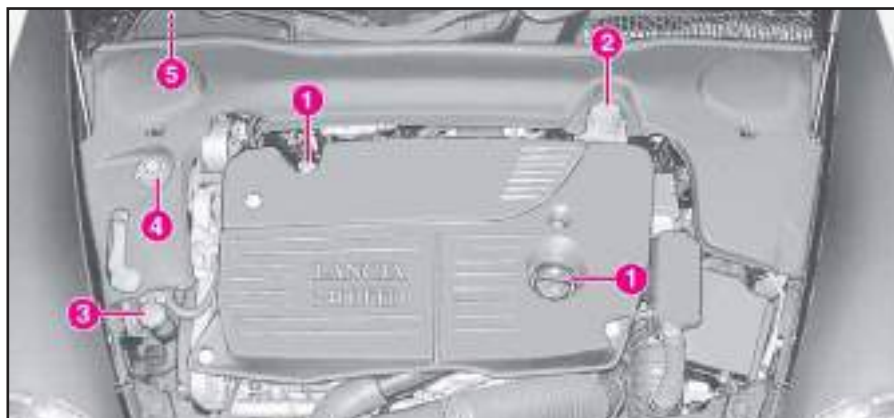

fig. 4 - 2.4 JTD 20V - 2.4 JTD 20V CAE versions

L0A0341b

- 1) Engine oil
- 2) Brake fluid
- 3) Windscreen/rear window and headlight washer fluid
- 4) Engine coolant
- 5) Power steering fluid

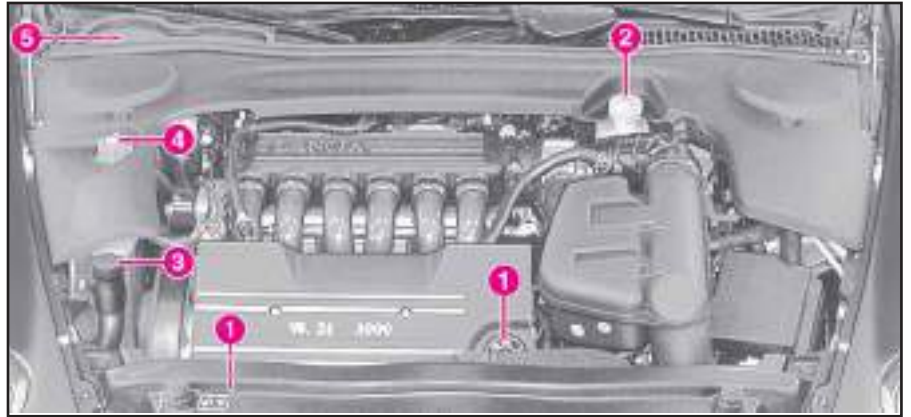

fig. 5 - 3.0 V6 CAE version

LOA0342b

- 1) Engine oil
- 2) Brake fluid
- 3) Windscreen/rear window and headlight washer fluid
- 4) Engine coolant
- 5) Power steering fluid

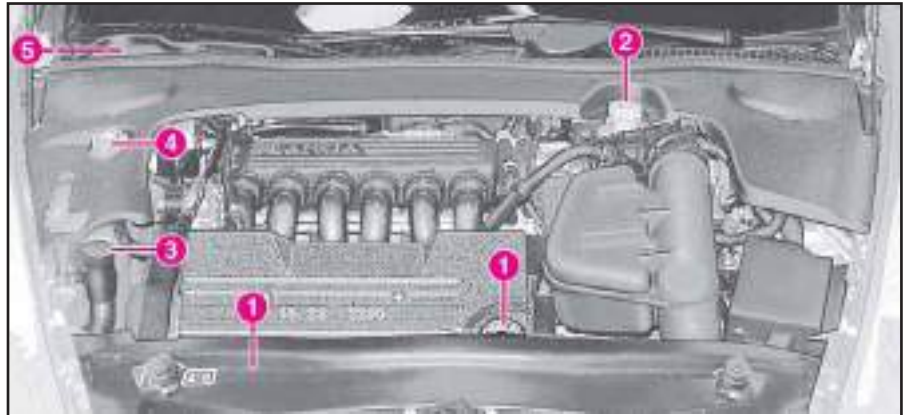

fig. 6 - 3.2 V6 CAE version

LOA0358b

ENGINE OIL

(fig. 7-8-9-10-11-12)

Check engine oil with the car on level ground and while the engine is still warm (approximately five minutes after stopping the engine).

Remove dipstick **A** and clean it, then plunge it down and check whether the oil level is included between the **MIN** and **MAX** reference lines on the dipstick. The gap between the **MIN** and **MAX** reference lines corresponds to approximately one litre of oil.



Be very careful under the bonnet: you risk burning yourself. Remember that when the engine is hot, the fan can start up and cause injuries.



Do not add oil with different specifications (class, viscosity, etc.) from the oil already in the engine.

If the oil level is near or even below the **MIN** line, pour in oil through the filler hole **B**, until it reaches the **MAX** line.

IMPORTANT If during a routine check you will find that the oil level is above the **MAX** reference line, contact a **Lancia Dealership** to have the proper level restored.



fig. 7 - 2.0 TB version



fig. 8 - 2.4 - 2.4 CAE versions

IMPORTANT After topping up, let the engine turn for a few seconds and wait a few minutes after stopping it before you check the level.

Engine oil consumption

Max. engine oil consumption is usually 400 grams every 1000 km.

When the car is new, the engine needs to run in, therefore the engine oil consumption can only be considered stabilised after the first 5000 - 6000 km.

IMPORTANT The oil consumption depends on the driving style and the conditions under which the car is used.



Used engine oil and replaced oil filters contain substances which can harm the environment. We recommend you have the car seen to at a Lancia Dealership for the oil and filter change. It is suitably equipped for disposing of used oil and filters in an environmentally friendly way that complies with the law.

ENGINE COOLANT (fig. 13)



Do not remove the reservoir cap when the engine is hot: you risk scalding yourself!

Check coolant level when the engine is cold and with the car on flat ground. The level should be included between **MIN** and **MAX** reference lines on the reservoir.

If the level is low, loosen the reservoir cap **A** and top up with **PARAFLU UP** until reaching the **MAX** reference line.



fig. 9 - 2.4 JTD version



fig. 11 - 3.0 V6 CAE version



fig. 10 - 2.4 JTD 20V -
2.4 JTD 20V CAE versions

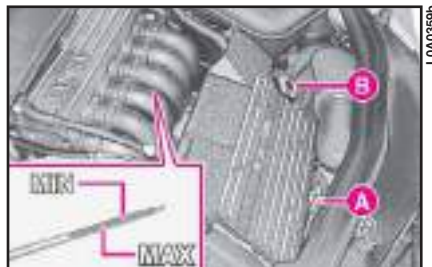

fig. 12 - 3.2 V6 CAE version



fig. 13



The engine cooling system works with **PARAFLU UP**. Top up only with the same fluid contained in the cooling circuit. **PARAFLU UP** cannot be mixed up with **PARAFLU 11** or other fluids. Should this take place, do not start the engine and contact a Lancia Dealership. In case of need, lacking the specified fluid, top up with water and contact a Lancia Dealership to have the proper proportions restored.



The cooling system is pressurised. If necessary, replace the cap with a genuine spare part to avoid compromising the system efficiency. The mixture of distilled water and **PARAFLU** gives freeze protection down to -35°C .

POWER STEERING FLUID (fig. 14-15)

Fluid level in the reservoir should be at the maximum.

This check should be performed when the engine is cold and with the car on level ground.

For topping up, remove cap **A**, after loosening the fastening screws **B** with the wrench provided (in the tool bag), then remove hose **C** and loosen cap **D**.

Check that the level reaches the **MAX** reference line on the dipstick integral with the reservoir cap (for cold check use the level indicated on the 20°C side of the dipstick).



fig. 14



fig. 15

If the fluid level in the reservoir is below the specified one, top up only with one of the products shown in table “Fluids and lubricants” in chapter “Technical Specifications” proceeding as follows:

- Start the engine and wait for the oil level in the reservoir to stabilise.
- With the engine running, turn the steering wheel lock to lock a few minutes.
- Top up to the **MAX** reference line and then refit the cap **D**.

- Refit hose C.
- Refit cap A and check for seal proper positioning into its seat, then secure the cap with screws B.



Do not let the power steering fluid come into contact with hot engine parts. It catches fire very easily.



Oil consumption is extremely low. If the oil level needs topping up again after a short period of time, have the system checked for leakage at a Lancia Dealership.

BRAKE AND HYDRAULIC CLUTCH FLUID (fig. 16)

Unscrew cap A: check that the fluid level in the reservoir is at maximum.

Fluid level in the reservoir shall not exceed the **MAX** mark.

If fluid has to be added, it is suggested to use the brake fluid in table "Fluids and lubricants" (see chapter "Technical characteristics").

NOTE Clean accurately the tank cap A and the surrounding surface.



fig. 16

At plug opening, pay maximum attention in order to prevent any impurities from entering the tank.

For topping up, always use a funnel with integrated filter with mesh equal to or lower than 0.12 mm.

IMPORTANT Brake fluid absorbs moisture, for this reason, if the car is mainly used in areas with a high degree of atmospheric humidity, the fluid should be replaced at more frequent intervals than specified in the "Service schedule".



Prevent brake fluid, which is highly corrosive, from coming into contact with painted parts. Should it happen, immediately wash with water.



Brake fluid is poisonous and highly corrosive. In the event of accidental contact, wash the parts involved immediately with neutral soap and water, then rinse thoroughly. Call the doctor immediately if the fluid is swallowed.



The symbol © on the container indicates synthetic brake fluid, distinguishing it from the mineral kind. Using mineral fluids irreversibly damages the special braking system rubber seals.

WINDSCREEN/REAR WINDOW/HEADLIGHT WASHER FLUID (fig. 17)

To top up, remove cap A and filler B.

Pour in a mixture of water and TUTELA PROFESSIONAL SC 35 fluid in the following concentrations:

- 30% of the above specified fluid and 70% water in summer
- 50% of the above specified fluid and 50% water in winter
- if the temperature falls below -20°C use TUTELA PROFESSIONAL SC 35 undiluted.



fig. 17



Certain commercial additives for windshield washers are inflammable. The engine compartment contains hot components which may set it on fire.



Do not travel with the windshield washer reservoir empty. The windshield washer is fundamental for improving visibility.



To prevent damages to the pump motor, do not use the windshield/rear window/headlight washers when the reservoir is empty.

AIR CLEANER

The air cleaner is connected to the air temperature and intake sensors which send the electrical signals required for the correct operation of the injection and ignition system to the control unit.

Consequently, the cleaner must always be in perfect conditions to ensure correct operation of the engine and in order to contain consumption and exhaust emissions.



The air cleaner replacement procedure is provided for indicative purposes only. Have the operation carried out at a Lancia Dealership. Car safety can be compromised if the cleaner replacement procedure herein described is not carried out correctly.



Replace the air cleaner more frequently than shown in the Service Schedule if the car is used on dusty roads.



The cleaner can be damaged if it is cleaned and consequently the engine can be damaged.

DIESEL FILTER (JTD versions)

DRAINING THE CONDENSE



The presence of water in the fuel feed circuit can severely damage the injection system and make the engine misfire. Go to a Lancia Dealership as soon as possible when the  warning light comes on together with message “WATER IN DIESEL FILTER” on the multifunction display to have the bleeding operation carried out.

DUST/POLLEN FILTER

This filter has a mechanical/electrostatic air filtering action, provided that windows and doors are closed.

Have the dust/pollen filter checked once a year at a **Lancia Dealership**, preferably at the onset of summer.

If the car is often used in dusty or extremely polluted environments, have the filter replaced more frequently than specified in the Service Schedule.

IMPORTANT Failure to replace this filter can significantly reduce climate control system effectiveness.

BATTERY

The battery is of the “Low Maintenance” type and is fitted with an indicator **A** (**fig. 18**) for checking the electrolyte level and battery charge.

Under normal condition of use topping up the electrolyte with distilled water is therefore not required. A periodical check is however necessary to make sure it is in efficient conditions through the indicator on the battery cover which should be dark in colour with a green central area.

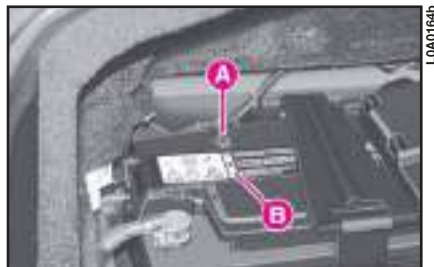

fig. 18

If the indicator is a bright colour, or dark without the green central area, contact a **Lancia Dealership**.



Batteries contain substances that are very harmful for the environment. You are advised to have the battery changed at a Lancia Dealership. It is properly equipped for disposing of used batteries in an environmentally-friendly way that complies with the law.



With the battery flat, or after the interruption of one of the protection fuses, or if you want to disconnect a loaded battery (e.g. for a car stop period), before opening the luggage compartment bonnet carefully read and comply with the instructions contained in the paragraph “If battery is to be disconnected” in the chapter “In an emergency”.



Incorrect fitting of electrical and electronic accessories can seriously damage the car. If you want to add accessories after buying the car (free-hand phone kit, etc.) visit a Lancia Dealership. They can suggest the most suitable accessories to get and check whether the electric system can support the required load or whether a larger capacity battery is required.



If the car is left inactive for long periods at cold, remove the battery and store it in a warm place to prevent freezing.



When working on the battery or near it, always wear the proper goggles.



Running the battery with low fluid level can damage the battery beyond repair and could also cause its explosion.

CHECKING THE BATTERY CHARGE

The quality of the battery charge can be checked through the indicator (where required).

If the battery is not fitted with electrolyte level indicator, the relevant checks must only be carried out by authorised personnel.

To check the battery charge, slacken the two fastening screws and open the cover. Check the battery charge and then reclose the cover, take care to prevent pinching and short circuits.

Depending on the colour of the indicator, proceed as described in the table below or on the label **B (fig. 18)** on the battery.

Bright white colour

Top up electrolyte

Contact a Lancia Dealership

Dark colour without green central area

Low battery charge

Charge the battery (advisable to contact a Lancia Dealership)

Dark colour with green central area

Electrolyte level and battery charge sufficient

No action needed

CHARGING THE BATTERY

IMPORTANT The battery charging procedure is described only for information purposes since this operation must be carried out by a **Lancia Dealership**.

Charging should be slow at a low amp rating for about 24 hours. Charging for a longer period of time may damage the battery.



Before reloading carefully read and comply with instructions contained in the paragraph “If battery is to be disconnected” in the chapter “In an emergency”.

To charge the battery proceed as follows:

- Disconnect battery negative terminal (-).
- Connect the battery charger wires to the battery terminals and check for proper bias.
- Turn the battery charger on.

– After charging, turn the battery charger off before disconnecting it from the battery.

– Reconnect the battery negative terminal (-).



The liquid in the battery is poisonous and corrosive. Do not let it touch the skin or eyes. Recharging the battery should be done in a well-ventilated area and away from naked flames or possible sources of sparks: explosion and fire risk.



Never attempt to charge a frozen battery: it must be thawed first, otherwise it may explode. If freezing has taken place, the battery should be checked before charging by specialised personnel, to make sure that the internal elements are not damaged and that the body is not cracked, with the risk of leaking poisonous and corrosive acid.

IMPORTANT A battery which is kept at a charge of less than 50% for any length of time will be damaged by sulphation leading to a reduction in cranking power and a higher risk of the battery electrolyte freezing (this may even occur at -10 °C). If the car is inactive for a long period of time, refer to “Storing the car”, in chapter “Driving your car”.

REPLACING THE BATTERY

If required, replace the battery with a genuine spare part presenting the same specifications. If a battery with different specifications is fitted, the frequencies shown in the Service Schedule in this chapter will no longer apply. Refer to the instructions provided by the battery Manufacturer.

IMPORTANT Before opening the luggage compartment bonnet to disconnect the battery, carefully read and comply with instructions contained in the paragraph “If battery is to be disconnected” in the chapter “In an emergency”.

USEFUL ADVICE FOR LENGTHENING THE LIFE OF YOUR BATTERY

To prevent rapidly draining the battery and ensure that it continues to work correctly, the following should be noted:

– Terminals must always be firmly tightened.

– Do not keep accessories (e.g. sound system, hazard lights, parking lights, etc.).

– When you park the car, ensure the doors, boot and bonnet are closed properly. The ceiling lights must be off.

– Before working on the electrical system, disconnect the negative cable from the battery.

– If after buying the car, you want to install electric accessories which require permanent electric supply, visit a **Lancia Dealership**, whose qualified personnel, in addition to suggesting the most suitable devices belonging to the Lineaccessori Lancia, will evaluate the overall electric absorption, checking whether the car's electric system is capable of withstanding the load required, or whether it should be integrated with a more powerful battery. These devices in fact take electricity also when the ignition key is removed (car parked, engine off), and can gradually drain the battery. The overall intake of these devices (standard and after-market) must be less than 0.6 mA x Ah (of the battery), as shown in the following table.

| Battery | Maximum idle intake |
|---------|------------------------|
| 70 Ah | 42 mA |
| 80 Ah | 48 mA |
| 100 Ah | 60 mA |

It is also important to remember that high intake devices (such as bottle warmers, vacuum cleaners, cellular phones, frigo bar, etc.) will speed up battery discharging when powered with engine off or running idle.

– Please note that when installing additional systems in the car, incorrect wiring can be dangerous especially when concerning safety systems.

ELECTRONIC CONTROL UNITS

When the car is being used normally, special measures are not necessary.

The following instructions must be followed very carefully, however, if you work on the electrical system or in cases where emergency starting is necessary:

- never disconnect the battery from the electrical system while the engine is running

- disconnect the battery from the electrical system if you are recharging it. The modern battery chargers can discharge voltage up to 20V

- never perform emergency start-ups with a battery charger. Always use an auxiliary battery

- be particularly careful when connecting the battery to the electrical system. Make sure that the polarity is correct and that the connection is efficient

- do not connect or disconnect the terminals of the electronic control unit while the ignition key is at **MAR**

- do not check polarity through sparking

- disconnect the electronic control units if you are electrically welding the car body. Remove the units if temperatures exceed 80°C (special operations on the bodywork, etc.).



Modifications or repairs to the electrical system carried out incorrectly and without bearing the features of the system in mind can cause malfunctions with the risk of fire.

SPARK PLUGS

The cleanness and soundness of the spark plugs are very important for keeping the engine efficient and polluting emissions down.

The appearance of the spark plug, if examined by expert eyes, is a good way of pinpointing a problem even if it has nothing to do with the ignition system. Therefore, if the engine has problems, it is important to have the spark plugs checked at a **Lancia Dealership**.



The spark plugs must be changed at the times specified in the Service Schedule. Only use the type of plugs indicated. If the heat ratio is less than required or the life specified is not guaranteed, problems can arise.

WHEELS AND TYRES

TYRE PRESSURE

Check the pressure of each tyre, including the spare, every two weeks and before long journeys.

The pressure should be checked with the tyre rested and cold.

It is normal for the pressure to rise when you are driving. If you have to check or restore the pressure when the tyres are warm, remember that the pressure value must be 0.3 bar above the specified value.

For proper tyre inflation pressure, see “Wheels” in chapter “Technical Specifications”.



Tyre pressure must be correct to ensure good road holding.



If the pressure is too low the tyre overheats and this can cause it serious damage.

Wrong pressure causes uneven wear of the tyres (**fig. 19**):

A - Correct pressure: tyre wears evenly.

B - Under inflated tyre: shoulder tread wear.

C - Over inflated tyre: centre tread wear.

Tyres must be replaced when the tread wears down to 1.6 mm. In any case, comply with the laws in the country where the car is being driven.

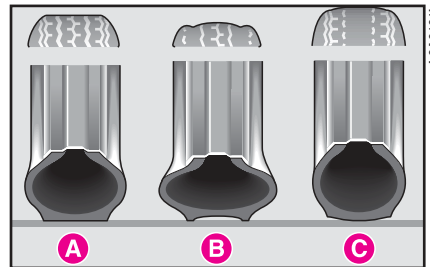

fig. 19

GENERAL NOTES

As far as possible, avoid sharp braking and screech starts, etc.

Be careful not to hit the kerb, potholes or other obstacles hard. Driving for long stretches over bumpy roads can damage the tyres. Periodically check that the tyres have no cuts in the sidewalls, abnormal swelling or irregular tyre wear. If any of these occur, have the car seen to at a **Lancia Dealership**.

Avoid overloading your car: this can seriously damage wheels and tyres.

If you get a flat tyre, stop immediately and change it so as not to damage the tyre, the wheel, the suspension and the steering. Tyres age even if they are not used very much. Cracking of the tread rubber and the sidewalls are a sign of this ageing. In any case, if the tyres have been fitted for more than six years they should be examined by an expert who can judge whether they are still fit for use. Remember to check the spare tyre particularly carefully too

If a replacement is necessary, always use new tyres and avoid using ones the origin of which you are not certain about.

Lancia THESIS fits tubeless tyres. Under no circumstances use an inner tube with these tyres.

If you replace a tyre it is a good idea to change the inflation valve, too.

To ensure the front and rear tyres all wear evenly, you are advised to change the tyres over every 10-15 thousand kilometres, keeping them on the same side of the car so as to not reverse the direction of rotation.



Do not change the tyres over in criss-cross fashion by moving a tyre from the left hand side of the car to the right and vice versa.

RUBBER TUBING

Follow the Service Schedule to the letter as concerns braking, power steering and fuel line rubber tubing. Ozone, high temperatures and long absence of fluid in the system can in fact cause the hardening and cracking of the pipes with possible loss of fluid. A careful check is therefore essential.

WINDSCREEN WIPERS

BLADES

Periodically clean the rubber part with suitable products. We recommend **TUTELA PROFESSIONAL SC 35**.

Change the blades if the rubber edge is warped or worn out. You should in any case change them approximately once a year.

Some simple steps can reduce potential damage to the blades:

- If the temperatures falls to below zero, make sure the rubber blade is not frozen to the windscreen. If necessary, free it with a de-icing compound.
- Remove any snow that has settled on the glass: besides saving the blades you will avoid straining the electric windscreen wiper motor and causing it to overheat.
- Do not operate the windscreen wipers on dry glass.



Travelling with worn wiper blades is dangerous because it reduces visibility in bad weather.

Checking the blades

Before checking, clean the windscreen and rubber blades carefully with warm water and soap or with **TUTELA PROFESSIONAL SC 35** windscreen washing fluid. The windscreen should be perfectly clean and not greasy. If required, complete the cleaning operation with degreasing products (ammonia based) or degreasing polishes.

The blades must also be perfectly clean before starting the check. If required, clean the corners with warm water and soap.

1) Check the blades carefully. They should not be broken or damaged in any part. Replace both the blades if they are broken or damaged.

2) If the blades are intact, continue by checking the operation. Operate the windscreen washer and the wiper. If the blades clean the windscreen perfectly they can be kept. If not, replace them both.

Replacing the blades (fig. 20)

To replace the windscreen wiper blades:

- 1) Lift the windscreen wiper arm.
- 2) Press the lock spring tab and remove the blade **A** from arm **B**.
- 3) Insert the new blade in the windscreen wiper arm until the lock spring clicks.

IMPORTANT After replacing, make sure that the blades are correctly fastened to the windscreen wiper arm.

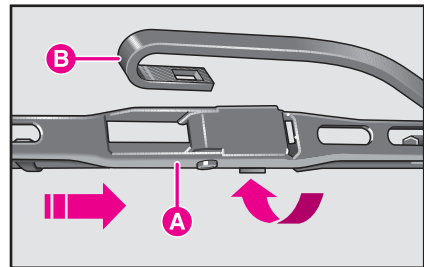

fig. 20

SPRAY NOZZLES (fig. 21)

If there is no jet of liquid, first make sure that there is liquid in the reservoir. Then make sure that the holes in the nozzles are not clogged up. Use a pin for this if necessary.

The windscreen washer jets can be directed through screw **A**. Direct the spray so that it reaches the highest point reached by the blades.



fig. 21

HEADLIGHT WASHERS

Regularly check that the nozzles (fig. 22) are intact and clean.

The headlight washers are automatically switched on when the windscreen washer is operated and the headlights are on.



fig. 22

CLIMATE CONTROL SYSTEM

During the winter, the climate control system must be turned on at least once a month for about ten minutes.

Before summer, have the system checked at a **Lancia Dealership**.



The system is filled with R134a refrigerant which will not pollute the environment in the event of leakage. Under no circumstances should R12 fluid be used as it is incompatible with the system components and contains CFC.

INITIALISING THE AIR CONDITIONING CONTROL UNIT

Whenever the battery is electrically connected again or it is reloaded after being completely flat or after replacing one of the protection fuses, to restore the correct operation of the air conditioning, of the door locking and of the ESP system. It is necessary to perform the initialisation operations contained in the paragraph "If battery is to be disconnected" in the chapter "In an emergency".

BODYWORK

PROTECTING THE CAR FROM ATMOSPHERIC AGENTS

The main causes of rust are:

- atmospheric pollution
- salty and humidity in the atmosphere (coastal or very hot and humid areas)
- environmental conditions that specific to the season.

In addition, the abrasiveness of dust in the atmosphere and sand carried by the wind as well as mud and stones kicked up by other cars must not be underestimated.

For your THESIS, LANCIA has used leading-edge technological solutions to effectively protect the body from rust.

These are most important:

- Painting systems and products that make the car particularly resistant to rust and scratching.
- The use of zinc-plated sheet steel which is highly resistant to rust.
- The spraying of the underbody, engine compartment, inside the wheelhouses and other parts with wax-based products with a high protective capacity.
- Spraying plastic-coating materials, to protect the most exposed points: under the door, inside the wings, the edges, etc.

– The use of “open” box sections to prevent condensation and water from building up and rusting the inside of the parts.

BODY AND UNDERBODY WARRANTY

Your THESIS is covered by warranty against any original structural or body part being perforated by rust. Refer to the Warranty Booklet for the general terms.

TIPS FOR KEEPING THE BODY IN GOOD CONDITIONS

Paintwork

The paintwork is not only to make your car look attractive but also to protect the steel.

If the paint is scuffed or scratched deeply you are therefore advised to touch up as necessary to prevent rust from forming.

Only use genuine products when touching up the paintwork (see “Bodywork paint identification plate” in chapter “Technical Specifications”).

Ordinary maintenance of the paintwork means washing it. The frequency you should do this depends on the conditions and the environment the car is driven in. For example, you should wash your car more often if it is driven in areas with a high level of air pollution or on road sprinkled with saltwash.



Before cleaning the windscreen (e.g. at filling stations), make sure to have deactivated the rain sensor and turned the ignition key to STOP. Deactivate the rain sensor also when washing your car manually or at automatic carwash.



Before leaving your car into the automatic carwash tunnel, disengage the parking brake following the instructions given in the relevant paragraph, and leave the Keyless System CID (where fitted) in the car to prevent automatic steering locking.



Detergents pollute water. For this reason the car must be washed in an area equipped for the collection and purification of the liquids used while washing.

Cleaning chromium plated/anodized bodywork parts

To clean body parts such as moldings, cappings, etc., use neutral pH detergents. Avoid generic cleaning products.

These parts shall be rinsed well with water and then dried with a jet of air or a chamois leather.

For further treatment use special polish for chromium plated/anodized parts.

Suitable car cleaning products are available at **Lancia Dealerships**.

To wash the car properly:

- 1) Remove the aerial from the roof to prevent damaging it when washing the car in an automatic carwash.
- 2) Wash the body using a low pressure jet of water.
- 3) Wipe a sponge with a light neutral PH detergent solution over the bodywork, frequently rinsing the sponge.
- 4) Rinse well with water and dry with a jet of air or a chamois leather.

When drying the car, be careful to get at those parts which are not so easily seen e.g. the door frames, bonnet and around the headlights where water can most readily collect.

You should leave the car out in the open so that any water remaining can evaporate more easily.

Do not wash the car after it has been parked in the sun or while the bonnet is hot: it could take the shine off the paint.

Outside plastic parts must be cleaned following the usual car washing procedure.

Where possible avoid parking the car under trees; the resinous substance that certain species of tree shed dull the paintwork and increase the possibility of rust forming.

IMPORTANT Bird droppings must be washed off immediately and with great care as their acid is particularly aggressive.

Windows

Use specific window cleaners to clean the windows. Use very clean cloths to avoid scratching the glass or damaging the transparency.

IMPORTANT To prevent damage to the electric heater element, wipe the inside of the heated rear window gently in the same direction as the elements.

Engine compartment

At the end of each winter season, carefully clean the engine compartment without directing the water jet against electronic control units. Have this done at a garage.



Detergents pollute water. For this reason the car must be washed in an area equipped for the collection and purification of the liquids used while washing.

IMPORTANT The car should be washed with the engine cold and the ignition key at **STOP**. After washing make sure that the various protections (e.g. rubber caps and various covers) have not been damaged or removed.

INTERIORS

From time to time check that water has not collected under the mats (from dripping shoes, umbrellas, etc.) which could cause the steel to rust.



Never use inflammable products like fuel oil ether or rectified petrol for cleaning inside the car. The electrostatic discharges generated when rubbing to clean may cause fire.



Do not keep aerosol cans in the car. There is the risk they might explode. Aerosol cans must never be exposed to a temperature above 50°C; when the weather starts to get hot the temperature inside the car might go well beyond that figure.

PLASTIC PARTS INSIDE THE CAR

Use special products designed not to alter the appearance of the components.

IMPORTANT Do not use alcohol or petrol to clean the instrument panel.

CLEANING ALCANTARA SEATS

Alcantara upholstery is easy to clean. Follow the same instructions provided for velvet upholstery.

CLEANING VELVET SEATS AND FABRICS

- Remove dust with a soft brush and vacuum cleaner. Use a moist brush to clean velvet upholstery.
- Brush the seats with a damp sponge with water and a neutral soap.

CLEANING LEATHER SEATS

- Remove the dry dirt with a chamois leather or very slightly moist loth without exerting too much pressure.
- Remove liquid or grease stains with a dry absorbent cloth without rubbing. Then wipe with a chamois leather or soft cloth moistened with water and neutral soap. If the stain does not come out, use a special cleaning compound being particularly careful to follow the instructions for use.

IMPORTANT Never use alcohol or alcohol-based products.



Upholstery of your car has been designed to withstand wear deriving from common use of the car. You are however recommended to avoid strong and/or continuous scratching with clothing accessories such as metallic buckles, studs, Velero fastenings and the like, since these items cause circumscribed stress of the cover fabric that could lead to yarn breaking, and damage the cover as a consequence.

STEERING WHEEL/GEAR LEVER KNOB WITH GENUINE LEATHER COVERING

These components shall only be cleaned with water and neutral soap. Never use spirit or alcohol-based products.

Before using special products for cleaning interiors, read carefully label instructions and indications to make sure they are free from spirit and/or alcohol-based substances.

If when cleaning the windscreen with special glass products, some drops fall on the leather covering of the steering wheel/gear lever knob remove them immediately and then clean with water and neutral soap.

IMPORTANT Take the utmost care when engaging the steering lock to prevent scratching the leather covering.

TECHNICAL SPECIFICATIONS

IDENTIFICATION DATA

CHASSIS MARKING (fig. 1)

It is printed on the passenger compartment floor in front of the right-hand front seat and can be reached by lifting the carpeting and opening the cover.

Marking includes the following data:

- car model
- chassis number.



fig. 1

ENGINE MARKING

The marking is stamped on the cylinder block and includes the model and the chassis number.

MODEL PLATE

The plate (fig. 2) is to be found on the left side of the boot (in the spare wheel housing) by lifting the boot cover. The plate bears the following identification data (fig. 3):

- A - Manufacturer's name
- B - Homologation number
- C - Car model code
- D - Chassis number
- E - Maximum vehicle weight fully loaded



fig. 2

F - Maximum vehicle weight fully loaded with trailer

G - Maximum vehicle weight on front axle

H - Maximum vehicle weight on rear axle

I - Engine type

L - Body version code

M - Spare part code

N - Smoke opacity index (for diesel engines)

BODYWORK PAINT IDENTIFICATION PLATE

The plate (**fig. 4**) is applied on the inner bonnet panel.

It bears the following data (**fig. 5**):

A - Paint manufacturer

B - Colour name

C - LANCIA colour code

D - Respray and touch up code



fig. 3

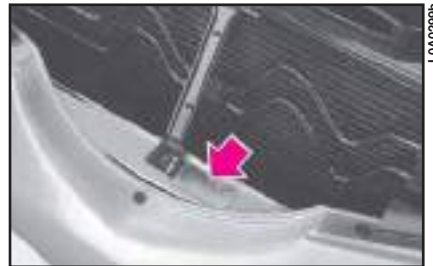

fig. 4



fig. 5

ENGINE CODES - BODYWORK VERSIONS

| | Engine code | Bodywork version |
|-----------------|-------------------------|---|
| 2.0 TB | 841E000 | 841AXA1B 03D 841AXA1B 03E (**) 841AXA1B 03F (*) |
| 2.4 | 841D000 | 841AXB1B 00C 841AXB1B 00D (*) |
| 2.4 CAE | 841D000 | 841AXB11 04C 841AXB11 04D (*) |
| 2.4 JTD 20V CAE | 841P000 841N000 (**) | 841AXN11 10 841AXH11 06B (**) 841AXM11 09 (**) |
| 3.2 V6 CAE | 841L000 | 841AXF11 07 |

(*) EURO 4 version (for specific markets)

(**) Version for specific markets

ENGINE

| | | 2.0 TB | 2.4 | 2.4 CAE |
|--------------------------------|-----|---------------------------------|---------------------------------|---------------------------------|
| GENERAL FEATURES | | | | |
| Engine code | | 841E000 | 841D000 | 841D000 |
| Location | | Front, transversally-mounted | Front, transversally-mounted | Front, transversally-mounted |
| Cycle | | Otto | Otto | Otto |
| Number and layout of cylinders | | 5 in line | 5 in line | 5 in line |
| Number of valves per cylinder | | 4 - Hydraulic tappets | 4 - Hydraulic tappets | 4 - Hydraulic tappets |
| Diameter x stroke | mm | 82 x 75.65 | 83 x 90.4 | 83 x 90.4 |
| Total capacity | cc | 1,998 | 2,446 | 2,446 |
| Compression ratio | | 8.5 : 1 | 10.3 : 1 | 10.3 : 1 |
| Maximum power (EEC): | kW | 136 | 125 | 125 |
| | HP | 185 | 170 | 170 |
| corresponding ratio | rpm | 5,500 | 6,000 | 6,000 |
| Maximum torque (EEC): | Nm | 308 | 226 | 226 |
| | Kgm | 31.4 | 23.0 | 23.0 |
| corresponding ratio | rpm | 2,200 | 3,500 | 3,500 |
| Fuel | | Unleaded petrol 95 R.O.N. | Unleaded petrol 95 R.O.N. | Unleaded petrol 95 R.O.N. |

| | | 2.4 JTD 20V CAE | 3.2 V6 CAE |
|--------------------------------|-----|---------------------------------|---------------------------------|
| GENERAL FEATURES | | | |
| Engine code | | 841H000 | 841L000 |
| Location | | Front, transversally-mounted | Front, transversally-mounted |
| Cycle | | Diesel | Otto |
| Number and layout of cylinders | | 5 in line | 6 V, 60° |
| Number of valves per cylinder | | 4 - Hydraulic tappets | 4 - Hydraulic tappets |
| Diameter x stroke | mm | 82 x 90.4 | 93 x 78 |
| Total capacity | cc | 2,387 | 3,179 |
| Compression ratio | | 17 : 1 | 10 : 1 |
| Maximum power (EEC): | kW | 136 | 169 |
| | HP | 185 | 230 |
| corresponding ratio | rpm | 4,000 | 6,200 |
| Maximum torque (EEC): | Nm | 330 | 289 |
| | Kgm | 34 | 29 |
| corresponding ratio | rpm | 1,750 | 4,800 |
| Fuel | | Diesel fuel for motor vehicles | Unleaded petrol 95 R.O.N. |

FUEL FEED - IGNITION

| | 2.0 TB | 2.4 | 2.4 CAE |
|-----------------|--|---|---|
| Fuel feed | BOSCH ME7 Multipoint sequential electronic injection, electronically controlled variable geometry turbosupercharger with intercooler | BOSCH ME3.1 Multipointsequential electronic injection | BOSCH ME3.1 Multipointsequential electronic injection |
| Ignition | Static electronic integral with ignition and single coil | Static electronic integral with ignition and single coil | Static electronic integral with ignition and single coil |
| Firing order | 1-2-4-5-3 | 1-2-4-5-3 | 1-2-4-5-3 |
| Injection order | - | - | - |
| Spark plugs | BOSCH FR6KTC | CHAMPION RC8BYC NGK BKR6EZ | CHAMPION RC8BYC NGK BKR6EZ |



Modifications or repairs to the fuel system that are not carried out properly or do not take the system's technical specifications into account can cause malfunctions leading to the risk of fire.

| | 2.4 JTD 20v CAE | 3.2 V6 CAE |
|-----------------|---|--|
| Fuel feed | BOSCH COMMON RAIL MULTIJET direct injection, BOSCH RADIALJET injection pump, electronically controlled variable geometry turbosupercharger with intercooler | BOSCH ME7 Multipointsequential electronic injection |
| Ignition | - | Static electronic integral with ignition and single coil |
| Firing order | - | 1-4-2-5-3-6 |
| Injection order | 1-2-4-5-3 | - |
| Spark plugs | - | NGK PFR6B |



Modifications or repairs to the fuel system that are not carried out properly or do not take the system's technical specifications into account can cause malfunctions leading to the risk of fire.

TRANSMISSION

| | 2.0 TB | 2.4 | 2.4 CAE |
|---------|--|--|---|
| Gearbox | Mechanical gearbox with six forward gears and reverse with synchromesh | Mechanical gearbox with six forward gears and reverse with synchromesh | Automatic gearbox with five forward gears and reverse |
| Clutch | Single disc, hydraulically controlled | Single disc, hydraulically controlled | - |
| Drive | Front | Front | Front |

BRAKES

| | 2.0 TB | 2.4 | 2.4 CAE |
|--------------------------------------|--|--|--|
| Service brakes: - front - rear | Self-ventilated discs Self-ventilated discs | Self-ventilated discs Self-ventilated discs | Self-ventilated discs Self-ventilated discs |
| Electric parking brake (EPB) | Electric control on rear discs, automatic engagement/disengagement | Electric control on rear discs, automatic engagement/disengagement | Electric control on rear discs, automatic engagement/disengagement |

| | 2.4 JTD 20V CAE | 3.2 V6 CAE |
|---------|---|---|
| Gearbox | Automatic gearbox with five forward gears and reverse | Automatic gearbox with five forward gears and reverse |
| Clutch | - | - |
| Drive | Front | Front |

| | 2.4 JTD 20V CAE | 3.2 V6 CAE |
|--------------------------------------|--|--|
| Service brakes: - front - rear | Self-ventilated discs Self-ventilated discs | Self-ventilated discs Self-ventilated discs |
| Electric parking brake (EPB) | Electric control on rear discs, automatic engagement/disengagement | Electric control on rear discs, automatic engagement/disengagement |

SUSPENSIONS

| | 2.0 TB | 2.4 | 2.4 CAE |
|-------|---|---|---|
| Front | Independent wheel, 5-link Multilink type, with aluminium wishbones, anti-roll bar, coil springs and telescopic shock absorbers. Telescopic shock absorbers with continuous damping action variation (SKYHOOK), where provided. | Independent wheel, 5-link Multilink type, with aluminium wishbones, anti-roll bar, coil springs and telescopic shock absorbers. Telescopic shock absorbers with continuous damping action variation (SKYHOOK), where provided. | Independent wheel, 5-link Multilink type, with aluminium wishbones, anti-roll bar, coil springs and telescopic shock absorbers. Telescopic shock absorbers with continuous damping action variation (SKYHOOK), where provided. |
| Rear | Independent wheel, multiple links, with lower wishbone and 3 control rods, anti-roll bar, coaxial coil springs and telescopic shock absorbers. Telescopic shock absorbers with continuous damping action variation (SKYHOOK), where provided. | Independent wheel, multiple links, with lower wishbone and 3 control rods, anti-roll bar, coaxial coil springs and telescopic shock absorbers. Telescopic shock absorbers with continuous damping action variation (SKYHOOK), where provided. | Independent wheel, multiple links, with lower wishbone and 3 control rods, anti-roll bar, coaxial coil springs and telescopic shock absorbers. Telescopic shock absorbers with continuous damping action variation (SKYHOOK), where provided. |

| | 2.4 | 2.4 JTD |
|-------|---|---|
| Front | Independent wheel, 5-link Multilink type, with aluminium wishbones, anti-roll bar, coil springs and telescopic shock absorbers. Telescopic shock absorbers with continuous damping action variation (SKYHOOK), where provided. | Independent wheel, 5-link Multilink type, with aluminium wishbones, anti-roll bar, coil springs and telescopic shock absorbers. Telescopic shock absorbers with continuous damping action variation (SKYHOOK), where provided. |
| Rear | Independent wheel, multiple links, with lower wishbone and 3 control rods, anti-roll bar, coaxial coil springs and telescopic shock absorbers. Telescopic shock absorbers with continuous damping action variation (SKYHOOK), where provided. | Independent wheel, multiple links, with lower wishbone and 3 control rods, anti-roll bar, coaxial coil springs and telescopic shock absorbers. Telescopic shock absorbers with continuous damping action variation (SKYHOOK), where provided. |

STEERING

| | 2.0 TB | 2.4 | 2.4 CAE |
|---|---|---|--|
| Control | Rack-and-pinion power steering gear. Optional, where provided, (VARIOSTEER) hydraulic power steering (power steering variable with speed) | Rack-and-pinion power steering gear. Optional, where provided, (VARIOSTEER) hydraulic power steering (power steering variable with speed) | Rack-and-pinion steering gear, with VARIOSTEER hydraulic power steering (power steering variable with speed) |
| Steering column | Energy-absorbing jointed steering column with manual or electric (position memory) angular adjustment system | Energy-absorbing jointed steering column with manual or electric (position memory) angular adjustment system | Energy-absorbing jointed steering column with manual or electric (position memory) angular adjustment system |
| Steering wheel | Energy-absorbing steering wheel | Energy-absorbing steering wheel | Energy-absorbing steering wheel |
| Minimum steering circle | metres | 12.2 | 12.2 |
| Number of steering wheel turns lock-to-lock | 2.24 | 2.24 | 2.16 |

| | 2.4 JTD 20V CAE | 3.2 V6 CAE |
|---|--|--|
| Control | Rack-and-pinion steering gear, with VARIOSTEER hydraulic power steering (power steering variable with speed) | Rack-and-pinion steering gear, with VARIOSTEER hydraulic power steering (power steering variable with speed) |
| Steering column | Energy-absorbing jointed steering column with manual or electric (position memory) angular adjustment system | Energy-absorbing jointed steering column with manual or electric (position memory) angular adjustment system |
| Steering wheel | Energy-absorbing steering wheel | Energy-absorbing steering wheel |
| Minimum steering circle metres | 12.2 | 12.2 |
| Number of steering wheel turns lock-to-lock | 2.16 | 2.16 |

WHEELS

| | 2.0 TB | 2.4 | 2.4 CAE |
|-----------------------|---------------------------------------|---------------------------------------|---------------------------------------|
| Standard tyres | | | |
| Rims | 7Jx16 H2-39 | 7Jx16 H2-39 | 7Jx16 H2-39 |
| Tyres | 215/60 R16 (95W) 215/60 ZR16 (95W) | 215/60 R16 (95W) 215/60 ZR16 (95W) | 215/60 R16 (95W) 215/60 ZR16 (95W) |
| Optional tyres | | | |
| Rims | 7Jx17 H2-41 | 7Jx17 H2-41 | 7Jx17 H2-41 |
| Tyres (*) | 225/50 R17 (94W) 225/50 ZR17 (94W) | 225/50 R17 (94W) 225/50 ZR17 (94W) | 225/50 R17 (94W) 225/50 ZR17 (94W) |
| Snow tyres | 215/60 R16 (95H) M+S | 215/60 R16 (95H) M+S | 215/60 R16 (95H) M+S |

(*) Chains cannot be fitted on these tyres

COLD TYRE INFLATION PRESSURE (excluding snow tyres)

| | 2.0 TB | 2.4 | 2.4 CAE |
|-----------------------------|--------|-----|---------|
| Front and rear tyres | | | |
| - average load | bar | 2.3 | 2.3 |
| - full load | bar | 2.3 | 2.3 |

| | 2.4 JTD 20V CAE | 3.2 V6 CAE |
|-----------------------|--|---------------------------------------|
| Standard tyres | | |
| Rims | 7Jx16 H2-39 | 7Jx16 H2-39 |
| Tyres | 215/60 R16 (95W) 215/60 ZR16 (95W) | 215/60 R16 (95W) 215/60 ZR16 (95W) |
| Optional tyres | | |
| Rims | 7Jx17 H2-37 7Jx17 H2-41 8Jx18 H2-37 | 7Jx17 H2-41 |
| Tyres (*) | 225/50 R17 (94W) 225/50 ZR17 (94W) 235/40 ZR18 (95Y) | 225/50 R17 (94W) 225/50 ZR17 (94W) |
| Snow tyres | 215/60 R16 (95H) M+S | 215/60 R16 (95H) M+S |

(*) Chains cannot be fitted on these tyres

COLD TYRE INFLATION PRESSURE (excluding snow tyres)

| | 2.4 JTD 20V CAE | 3.2 V6 CAE |
|----------------------|-----------------|------------|
| Front and rear tyres | | |
| - average load | 2.3/2.7 (*) | 2.3 |
| - full load | 2.3/2.7 (*) | 2.3 |

(*) Pressure for 235/40 ZR 18 (95Y) tyre

RIMS AND TYRES

Alloy rims or steel.

Tubeless tyres with radial carcass.

The homologated tyres are listed in the log book.

IMPORTANT In the event of discrepancies between information given in the Owner Handbook and that shown in the Log Book, refer to the latter one.

To ensure safety of the car in movement, it must be fitted with tyres of specified size and of the same make and type on all wheels.

IMPORTANT Do not use inner tubes with tubeless tyres.

CORRECT TYRE READING

Below, please find the instructions needed to understand the meaning of the code stamped on the tyre, as shown in **fig. 6**.

The code may be in one of the ways given in the example.

Example:
225/50 R 17 94 W
or
225/50 ZR 17 94W

225 = Nominal width (S, distance in mm between sides)

50 = Percentage height/width ratio (H/S)

R = Radial tyre

ZR = Radial tyre, with speed over 240 km/h

17 = Rim diameter in inches (\emptyset)

94 = Load index (capacity)

W = Maximum speed index.

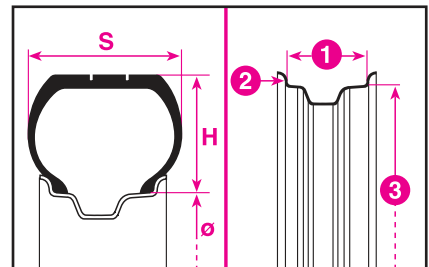

fig. 6

Load index (capacity)

| | |
|-------------|--------------|
| 60 = 250 kg | 84 = 500 kg |
| 61 = 257 kg | 85 = 515 kg |
| 62 = 265 kg | 86 = 530 kg |
| 63 = 272 kg | 87 = 545 kg |
| 64 = 280 kg | 88 = 560 kg |
| 65 = 290 kg | 89 = 580 kg |
| 66 = 300 kg | 90 = 600 kg |
| 67 = 307 kg | 91 = 615 kg |
| 68 = 315 kg | 92 = 630 kg |
| 69 = 325 kg | 93 = 650 kg |
| 70 = 335 kg | 94 = 670 kg |
| 71 = 345 kg | 95 = 690 kg |
| 72 = 355 kg | 96 = 710 kg |
| 73 = 365 kg | 97 = 730 kg |
| 74 = 375 kg | 98 = 750 kg |
| 75 = 387 kg | 99 = 775 kg |
| 76 = 400 kg | 100 = 800 kg |
| 77 = 412 kg | 101 = 825 kg |
| 78 = 425 kg | 102 = 850 kg |
| 79 = 437 kg | 103 = 875 kg |
| 80 = 450 kg | 104 = 900 kg |
| 81 = 462 kg | 105 = 925 kg |
| 82 = 475 kg | 106 = 950 kg |
| 83 = 487 kg | |

Maximum speed index

| |
|---------------------------|
| Q = up to 160 km/h |
| R = up to 170 km/h |
| S = up to 180 km/h |
| T = up to 190 km/h |
| U = up to 200 km/h |
| H = up to 210 km/h |
| V = over 210 km/h |
| ZR = over 240 km/h |
| W = up to 270 km/h |
| Y = up to 300 km/h |

Maximum speed index for snow tyres

| |
|--------------------------------|
| QM + S = up to 160 km/h |
| TM + S = up to 190 km/h |
| HM + S = up to 210 km/h |

CORRECT RIM READING

Below, please find the instructions needed to understand the meaning of the code stamped on the rim, as shown in **fig. 6**.

Example: **7 J x 16 H2 39**

- 7** = rim width in inches (1)
- J** = rim drop centre outline (side projection where the tyre bead rests) (2)
- 16** = rim nominal diameter in inches (corresponds to diameter of the tyre to be mounted) (3 = Ø)
- H2** = hump shape and number (relief on the circumference holding the tubeless tyre bead on the rim)
- 39** = wheel camber (distance between rim point of contact and wheel rim centre line)

WHEEL GEOMETRY

| | 2.0 TB | 2.4 2.4 CAE | 2.4 JTD 20v CAE | 3.2 V6 CAE |
|------------------------------|--------------|----------------|-----------------|--------------|
| Front wheels (STD A): | | | | |
| - caster angle | 2° 40' | 2° 40' | 2° 40' | 2° 40' |
| - kingpin angle | -50° ± 20' | -50° ± 20' | -50° ± 20' | -50° ± 20' |
| - toe-in | -1 mm ± 1 mm | -1 mm ± 1 mm | -1 mm ± 1 mm | -1 mm ± 1 mm |
| Rear wheels (STD A): | | | | |
| - kingpin angle | -41° ± 20' | -41° ± 20' | -41° ± 20' | -41° ± 20' |
| - toe-in | +3 mm ± 1 mm | +3 mm ± 1 mm | +3 mm ± 1 mm | +3 mm ± 1 mm |

PERFORMANCE

| | | 2.0 TB | 2.4 | 2.4 CAE | 2.4 JTD 20v CAE | 3.2 V6 CAE |
|-------------------------------|------|--------|------|---------|--------------------|------------|
| Top speed | km/h | 224 | 217 | 215 | 222 | 240 |
| Acceleration from 0-100 km/h | sec. | 8.9 | 9.5 | 10.0 | 9.7 | 8.8 |
| Kilometre with standing start | sec. | 28.9 | 30.2 | 31.2 | 31 | 29.3 |

DIMENSIONS

The sizes are in mm and refer to the car fitted with standard tyres.
Slight size changes with optional tyres. Height is intended for an unladen car.
Boot volume (as per VDA standards): 400 dm³

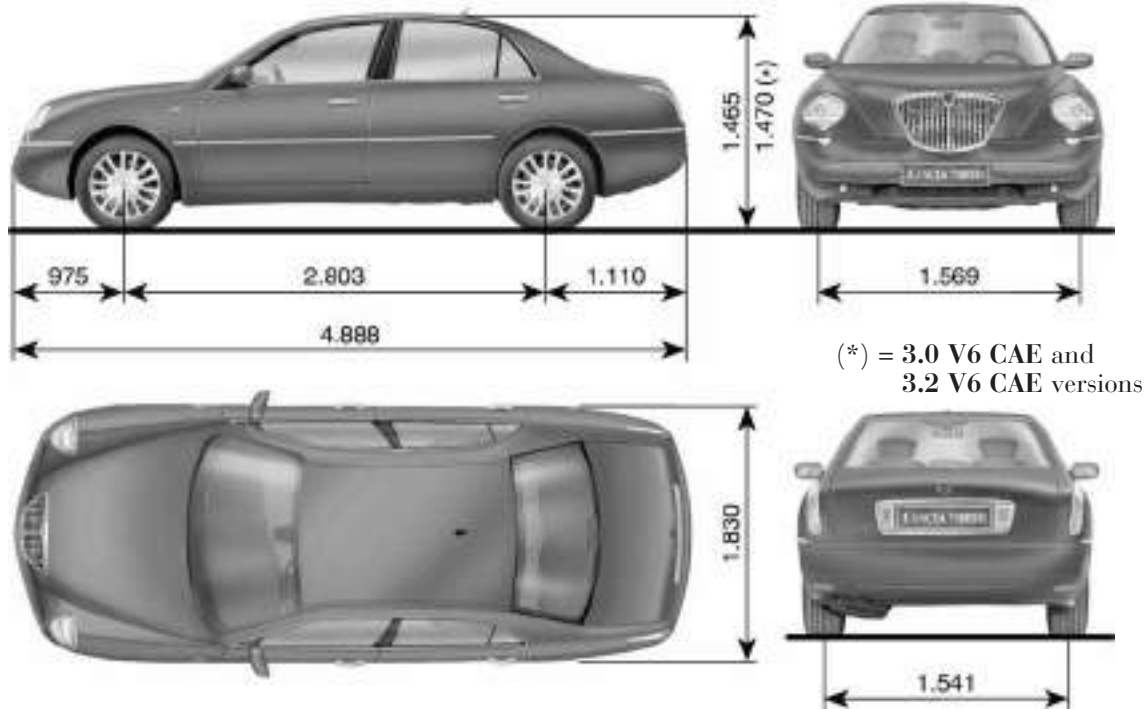

fig. 7

L0A0171b

WEIGHTS

| | | 2.0 TB | 2.4 | 2.4 CAE |
|--|----|--------|-------|---------|
| Empty weight (including all fluids, fuel tank at 90 % and with no optional): | kg | 1,780 | 1,760 | 1,790 |
| Payload (*) including the driver | kg | 510 | 510 | 510 |
| Maximum admitted loads (**): | | | | |
| – front axle | kg | 1,300 | 1,300 | 1,300 |
| – rear axle | kg | 1,300 | 1,300 | 1,300 |
| – total | kg | 2,290 | 2,270 | 2,300 |
| Towable loads: | | | | |
| – trailer with brakes | kg | 1,500 | 1,500 | 1,500 |
| – trailer without brakes | kg | 500 | 500 | 500 |
| Maximum load on roof | kg | 80 | 80 | 80 |
| Maximum load on tow hitch (trailer with brakes) | kg | 75 | 75 | 75 |
| Number of seats | | 5 | 5 | 5 |

(*) If special equipment is fitted (sunroof, tow hitch, etc.), the unladen car weight increases, thus reducing the specified payload.

(**) Loads not to be exceeded. The driver is responsible for arranging the loads so that they comply with these limits.

| | | 2.4 JTD 20v CAE | 3.2 V6 CAE |
|--|----|-----------------|------------|
| Empty weight (including all fluids, fuel tank at 90 % and with no optional): | kg | 1,820 | 1,820 |
| Payload (*) including the driver | kg | 510 | 510 |
| Maximum admitted loads (**): | | | |
| – front axle | kg | 1,300 | 1,300 |
| – rear axle | kg | 1,300 | 1,300 |
| – total | kg | 2,330 | 2,330 |
| Towable loads: | | | |
| – trailer with brakes | kg | 1,500 | 1,500 |
| – trailer without brakes | kg | 500 | 500 |
| Maximum load on roof | kg | 80 | 80 |
| Maximum load on tow hitch (trailer with brakes) | kg | 75 | 75 |
| Number of seats | | 5 | 5 |

(*) If special equipment is fitted (sunroof, tow hitch, etc.), the unladen car weight increases, thus reducing the specified payload.

(**) Loads not to be exceeded. The driver is responsible for arranging the loads so that they comply with these limits.

CAPACITIES

| | | 2.0 TB | 2.4 | 2.4 CAE | Prescribed fuels Recommended product |
|---|--------|------------|------------|------------|--|
| Fuel tank: | litres | 75 | 75 | 75 | Unleaded petrol with a RON not lower than 95 |
| – including a reserve of | litres | 10 | 10 | 10 | |
| Fuel tank: | litres | – | – | – | Diesel fuel for motor vehicles (Specification EN590) |
| – including a reserve of | litres | – | – | – | |
| Engine cooling system | litres | 8.6 | 8.6 | 8.6 | 50-50 mixture of distilled water and PARAFLU UP |
| Engine oil (amount for periodical change – sump and filter) | litres | 5.50 | 5.50 | 5.50 | SELENIA RACING |
| Engine oil (amount for periodical change – sump and filter) | litres | – | – | – | SELENIA WR |
| Manual gearbox/differential | kg | 1.70 | 1.70 | – | TUTELA CAR TECHNYX |
| Electronic automatic gearbox | litres | – | – | 7.25 | TUTELA CAR GI/V |
| Hydraulic power steering | litres | 1.05 | 1.05 | 1.05 | TUTELA CAR GI/E |
| Hydraulic brake circuit with ABS | litres | approx 1.5 | approx 1.5 | approx 1.5 | TUTELA TOP 4 |
| Windscreen headlight washer reservoir | litres | 4.5 | 4.5 | 4.5 | Mixture of water and TUTELA PROFESSIONAL SC 35 |

| | | 2.4 JTD 20V CAE | 3.2 V6 CAE | Prescribed fuels Recommended product |
|---|--------|--------------------|---------------|--|
| Fuel tank: | litres | – | 75 | Unleaded petrol with a RON not lower than 95 |
| – including a reserve of | litres | – | 10 | |
| Fuel tank: | litres | 75 | – | Diesel fuel for motor vehicles (Specification EN590) |
| – including a reserve of | litres | 10 | – | |
| Engine cooling system | litres | 8.6 | 12.2 | 50-50 mixture of distilled water and PARAFLU UP |
| Engine oil (amount for periodical change – sump and filter) | litres | – | 5.90 | SELENIA RACING |
| Engine oil (amount for periodical change – sump and filter) | litres | 5.0 | – | SELENIA WR |
| Electronic automatic gearbox | litres | – | – | TUTELA CAR GI/V |
| Hydraulic power steering | litres | 1.05 | 1.05 | TUTELA CAR GI/E |
| Hydraulic brake circuit with ABS | litres | approx 1.5 | approx 1.5 | TUTELA TOP 4 |
| Windscreen headlight washer reservoir | litres | 4.5 | 4.5 | Mixture of water and TUTELA PROFESSIONAL SC 35 |

FLUIDS AND LUBRICANTS

PRODUCTS WHICH MAY BE USED AND THEIR SPECIFICATIONS

| Use | Fluid and lubricant specifications for correct car operation | Original fluids and lubricants | Change |
|-------------------------------|---|--|-------------------------------|
| Lubricants for petrol engines | Synthetic-based oils, grade SAE 10W-60, FIAT 9.55535-H3 qualification. | SELENIA RACING Contractual Technical Reference N° F007.A00 | According to Service Schedule |
| Lubricants for diesel engines | Synthetic-based oils, grade SAE 5W-40, FIAT 9.55535-M2 qualification. | SELENIA WR Contractual Technical Reference N° F515.D06 | According to Service Schedule |

For regular operation of JTD versions fitted with DPF, use genuine lubricant only. In the event of an emergency, lacking the genuine lubricant, top up just once with max. 0.5 l and go to Lancia Dealership as soon as possible

Should non-genuine products be used, lubricants with minimum ACEA A3 properties for petrol engines and ACEA B4 for Diesel engines are tolerated; in this event top engine performance is not guaranteed.

Using low-quality products, not compliant with ACEA A3 and ACEA B4 properties and specifications could cause engine damages not covered by warranty.

For very cold temperatures, consult Lancia Dealership for the proper **Selenia** product to use.

| Use | Fluid and lubricant specifications for correct car operation | Original fluids and lubricants | Applications |
|--|---|---|--|
| Transmission and hydraulic power steering lubricants and greases | Synthetic-based oil, grade SAE 75W-85 that passes API GL 4 specifications Plus, Fiat 9.55550. | TUTELA CAR TECHNIX Contractual Technical Reference N° F010.B05 | Mechanical gearbox and differential petrol version |
| | Synthetic-based oil, grade SAE 75W-85, that pass API GL4 specifications. | TUTELA CAR MATRYX Contractual Technical Reference N° F108.F02 | Mechanical gearbox and differentials, diesel versions |
| | "ATF DEXRON III" oil.. | TUTELA GI/E Contractual Technical Reference N° F001.C94 | Power steering |
| | Special lubricant for 5-speed transmissions with controlled slip torque converters | TUTELA GI/V Contractual Technical Reference N° F333.105 | 5-speed automatic transmission |
| | Grease containing Molybdenum bisulphide for high temperature appliances. N.L.G.I. 1-2 consistency.y | TUTELA ALL STAR Contractual Technical Reference N° F702.G07 | CV joints on wheel side |
| | Poly-urea oil synthetic-based grease suitable for high temperatures. NL.GI. 2 consistency | TUTELA STAR 325 Contractual Technical Reference N°F301.D03 | CV joints on differential side |
| Brake fluid | Synthetic fluid FMVSS no. 116, DOT 4, ISO 4925, SAE J-1704 CUNA NC 956-01 | TUTELA TOP 4 Contractual Technical Reference N° F001.A93 | Brake and clutch hydraulic control |
| Protective agent for radiators | Protective with antifreeze action, red colour based on inhibited monoethylen glycol and organic formula, that passes CUNA NC 956-16, ASTM D 3306 specifications | PARAFLU UP (*) Contractual Technical Reference N° F101.M01 | Cooling circuits Proportion: 50% water and 50% PARAFLU UP |
| Windscreen/headlight washer fluid | Mixture of alcohol, water and surfactants CUNA NC 956-11 | TUTELA PROFESSIONAL SC 35 Contractual Technical Reference N° F201.D02 | To be used diluted or undiluted |

(*) IMPORTANT Do not top up or mix with fluids having characteristics different from those specified.

(□) When the vehicle is used under particularly harsh climate conditions, we recommend using a 60-40 mixture of PARAFLU UP and demineralised water.

FUEL CONSUMPTION

The fuel consumption values shown in the following table were defined according to the type-approval specifications in European Directives.

Consumption values are defined by means of the following procedures:

– **urban cycle:** consisting of a cold start and a simulated drive in city streets;

– **extra-urban cycle:** consisting in frequent accelerations, in all gears, simulating normal conditions of use. Speed ranges from 0 to 120 km/h;

– **combined consumption:** consisting of 37% urban cycle and 63% extra-urban cycle.

IMPORTANT Road and traffic conditions, weather, general conditions of the car, driving style, fittings and accessories, use of the climate control system, load, roof racks and other situations penalising aerodynamic penetration and effecting rolling resistance will influence fuel consumption rates which can be different from the values shown in the table (see “Cheap running that respects the environment” in “Driving your car” chapter).

| Consumption according to Directive 1999/100/CE (litres x 100 km) | 2.0 TB | 2.4 | 2.4 CAE | 2.4 JTD 20V CAE | 3.2 V6 CAE |
|--|--------|------|---------|-----------------|------------|
| Urban | 15.5 | 15.2 | 17.4 | 12.1 | 22.7 |
| Extra-urban | 8.5 | 8.4 | 8.8 | 6.9 | 10.3 |
| Average combined | 11.1 | 10.9 | 12.0 | 8.8 | 14.9 |

CO₂ EMISSION IN EXHAUST

The CO₂ emission in exhaust shown in the following tables refers to the combined consumption.

| CO ₂ emissions according to Directive 1999/100/CE | 2.0 TB | 2.4 | 2.4 CAE | 2.0 JTD 20V CAE | 3.2 V6 CAE |
|--|--------|-----|---------|-----------------|------------|
| (g/km) | 264 | 260 | 286 | 234 | 355 |

INDEX

- A**BS system 245
- EBD electronic
brakeforce distributor 245
- Accessories purchased by
the user 221
- Active carbon dust/
pollen filter 161
- maintenance 326
- Aerosol cans (important) 340
- Air bags (front and side) 88
- front passenger
presence sensor 91
 - general notes 95
 - manually deactivating
the passenger's
front air bag 90
 - manually deactivating
the rear side bags 94
 - passenger's
front air bag 90
 - side air bags (Side bag –
Window bag) 92
 - “Smart Bag” system
(front Multistage
Airbags) 88
- Air cleaner 325
- Air vents 144-145
- Anchoring the load 232
- Anti-lifting sensor 42
- Armrests
- front 65
 - rear 67
- Ashtray
- front 215
 - rear 215
- ASR system 189
- Autoclose function 50
- Automatic climate control
system 146
- controls 152
 - front control panel 148
 - general 146
 - how to use the climate
control system 151
 - maintenance 335
 - rear control panel 150
- Automatic gearbox display 110

| | | | |
|----------------------------|---------|--|------------|
| B attery | | | |
| - checking the battery | | | |
| charge..... | 327 | | |
| - disconnecting the loaded | | | |
| battery..... | 302 | | |
| - disconnecting the | | | |
| unloaded battery..... | 303 | | |
| - initialising the control | | | |
| units of the door locks, | | | |
| air conditioner and ESP | | | |
| system..... | 303 | | |
| - jump starting..... | 272-304 | | |
| - maintenance | 326 | | |
| - recharging the | | | |
| battery | 304-328 | | |
| - replacement | 328 | | |
| - useful advice | 329 | | |
| Bodywork | | | |
| - maintenance | 337 | | |
| - version code | 343 | | |
| | | Bodywork paint | |
| | | identification plate | 342 |
| | | Bodywork versions (codes) | 343 |
| | | Bonnet | 237 |
| | | Boot | |
| | | - anchoring the load | 232 |
| | | - ceiling light..... | 231 |
| | | - closing the boot..... | 231 |
| | | - functions that can be | |
| | | modified by the | |
| | | CONNECT menu..... | 229 |
| | | - luggage nets..... | 231 |
| | | - luggage transport - | |
| | | important notes | 233 |
| | | - opening by remote | |
| | | control..... | 228 |
| | | - opening from the inside | 227 |
| | | - opening from the outside | |
| | | with the key..... | 228 |
| | | - power socket | 234 |
| | | Boot light | |
| | | - bulb replacement..... | 290 |
| | | | |
| | | Bose HI-FI audio system | 248 |
| | | Bottle/can holder | |
| | | - front | 217 |
| | | - rear | 219 |
| | | Brake and hydraulic | |
| | | clutch fluid | 323 |
| | | Brakes | |
| | | - fluid level | 323 |
| | | - technical specifications | 348 |
| | | Bulbs (replacing) | 281 |
| | | - bulbs | 283 |
| | | - front light cluster..... | 284 |
| | | - general instructions | 282 |
| | | - rear light cluster | 286 |
| | | - replacing an exterior light.. | 284 |
| | | - types of bulbs | 282 |
| | | | |
| | | C apacities | 362 |
| | | Car maintenance | 309 |
| | | - additional checks | 314 |

| | | | | | |
|--|-----|--|-----|--|-----|
| - Annual Inspection Schedule | 314 | - presetting for mounting the “Type Isofix” child restraint system..... | 85 | CO ₂ emissions..... | 367 |
| - Scheduled Servicing | 309 | Children | | CODE Card | |
| - Service Schedule | 312 | (transport in safety) | 81 | (Lancia CODE system) | 28 |
| Carrying children safely | 81 | CID (Customer Identification Device) | 44 | CONNECT controls | 15 |
| Catalytic converter | | - battery replacement | 53 | CONNECT infotelematic system..... | 14 |
| - oxidising catalytic converter | 7 | CID device | | - CONNECT controls | 15 |
| - three-way catalytic converter | 6 | (Keyless System) | 44 | - controls on steering wheel.. | 18 |
| Central console compartment.. | 218 | Cigar lighter | 215 | - control summarising table | 21 |
| Chassis (marking) | 341 | Climate control system | 142 | - remote control | 19 |
| Cheap running that | | - air vents | 145 | Containing running costs | |
| respects the environment..... | 262 | - directional and adjustable vents..... | 144 | and pollution..... | 260 |
| Child lock safety device | 58 | - initialising the control units of the door locks, air conditioner and ESP system..... | 303 | Controls | 170 |
| Child restraint systems | 81 | - ventilation during a stop ... | 161 | Controls on steering wheel | 18 |
| - passenger seat | | Climate-controlled | | Courtesy mirrors | 214 |
| compliance with regulations | | drink compartment | 217 | Courtesy mirror lights | |
| on child’s seat use..... | 84 | | | - bulb replacement | 290 |
| | | | | Cruise Control (constant speed regulator) | 194 |
| | | | | D ashboard | 12 |

| | | | | | |
|----------------------------------|-----|--|-----|---------------------------------|-----|
| Dead lock device (doors)..... | 56 | - door pockets | 218 | - emergency | |
| Delayed light switching off | | - initialising the control | | disengagement | 178 |
| (Follow me home) | 99 | units of the door locks, | | Electric sunshade | 220 |
| Diesel filter | | air conditioner and ESP | | Electric windows | 73 |
| - draining the condense | 325 | system..... | 303 | - anti-trap safety system | 73 |
| Dimensions | 359 | - lock release in case | | - centralised window and | |
| Dipped beam headlights | | of accident | 59 | sunroof opening/closing | |
| - control | 97 | - opening/closing | | system..... | 75 |
| Direction indicators | | from the inside | 57 | - controls | 74 |
| - control | 100 | - opening/closing | | - manual and automatic | |
| - side bulb replacement | 285 | from the outside..... | 54 | operation | 75 |
| Door lights | | Drink compartment | | Electronic alarm | 39 |
| - bulb replacement | 291 | (climate-controlled) | 217 | - anti-lifting sensor..... | 41 |
| - puddle lights | 213 | Driving your car | 250 | - deactivating the alarm | 42 |
| Doors | 54 | E asy Entry/Exit (system) | 43 | - functions that can be | |
| - Autoclose function | 50 | EBD (electronic brakeforce | | deactivated or modified | 42 |
| - automatic door locking | 58 | distributor)..... | 245 | - indications of attempts | |
| - child lock safety device | 58 | E.G.R. (exhaust gas | | to break in..... | 42 |
| - dead lock device | 56 | recirculation system) | 7 | - ministerial homologation ... | 43 |
| - disabling rear door locking/ | | Electric parking brake(EPB) .. | 175 | - switching the alarm off..... | 41 |
| unlocking controls | 58 | | | - switching the alarm on | 40 |
| - door open indication | 57 | | | - volumetric protection | 41 |

| | | | | |
|--|-----|---|--|-----|
| - what triggers the alarm off | 42 | Engine | - ESP system action | 192 |
| Electronic automatic gearbox (COMFORTRONIC)..... | 180 | - identification code | - failure indication | 192 |
| - automatic operation..... | 182 | - marking | - initialising the control units of the door locks, air conditioner and ESP system..... | 303 |
| - bump starting..... | 188 | - technical specifications | - MSR system..... | 192 |
| - failure indication | 187 | Engine compartment (cleaning) | - operation | 190 |
| - gearbox display..... | 110 | 339 | Exhaust gas (recirculation system) | 7 |
| - manual sequential operation | 186 | Engine coolant | External lights (controls) | 97 |
| - moving off | 180 | 321 | F lash consumption gauge | 109 |
| - selecting the automatic/ manual sequential operation | 182 | Engine coolant temperature gauge | Flashing the headlights (main beam) | 100 |
| - sound signal | 188 | 108 | Fluids and lubricants | 364 |
| - starting the engine | 180 | Engine oil | Follow me home (delayed light switching off) | 99 |
| - stopping..... | 181 | - checking level | Front ceiling light | 212 |
| - technical specifications | 348 | - specifications | - bulb replacement | 287 |
| - towing the car | 189 | 364 | | |
| Electronic brakeforce distributor (EBD)..... | 245 | Engine oil consumption | | |
| Electronic control units (important) | 330 | 321 | | |
| | | Engine oil level | | |
| | | 320 | | |
| | | Engine warming up | | |
| | | 252 | | |
| | | Environment | | |
| | | (safety and protection)..... | | |
| | | 4-5 | | |
| | | EOBD system | | |
| | | 244 | | |
| | | EPB (electric parking brake) .. | | |
| | | 175 | | |
| | | - emergency disengagement.. | | |
| | | 178 | | |
| | | ESP system | | |
| | | 189 | | |
| | | - ASR function | | |
| | | 191 | | |

| | | | |
|--|-----|--|-----|
| Front fog lights | | | |
| - bulb replacement | 285 | | |
| - control | 171 | | |
| Front passenger presence sensor (airbag)..... | 91 | | |
| Front seats | 60 | | |
| - armrests..... | 65 | | |
| - Comfort Seats | 64 | | |
| - electrically adjustable seats | 60 | | |
| - head restraints | 65 | | |
| - heating | 62 | | |
| - manually adjustable seats (moving the seat backward and forward) | 60 | | |
| - paper pockets | 221 | | |
| - storing the driver's seat positions | 62 | | |
| Fuel | | | |
| - consumption | 366 | | |
| - cut-off switch | 173 | | |
| - fuel tank cap | 238 | | |
| | | - level gauge | 108 |
| | | Fuel consumption | 366 |
| | | Fuel cut-off switch and circuit breaker..... | 173 |
| | | Fuel evaporation canister | 6 |
| | | Fuel feed/ignition | |
| | | - technical specifications | 346 |
| | | Fuel filler cap..... | 238 |
| | | Fuel gauge..... | 108 |
| | | Fuses (replacing) | 292 |
| | | - fuses | 296 |
| | | - fuses in the boot | 295 |
| | | - fuses in the dashboard..... | 294 |
| | | - fuses in the engine compartment | 294 |
| | | - general | 292 |
| | | - general fuses | 293 |
| | | - location | 293 |
| | | Getting to know your car | 12 |
| | | Glove compartment | 216 |
| | | Glove compartment light | |
| | | - bulb replacement | 289 |
| | | H andles | 221 |
| | | Hazard lights | 170 |
| | | Headlight washer | |
| | | - control | 101 |
| | | - fluid | 324 |
| | | Headlights | |
| | | - (Bi-Xeno) gas-discharge lamps..... | 241 |
| | | - headlight orientation for left-/right-hand drive .. | 243 |
| | | Head restraints | |
| | | - front | 65 |
| | | - rear | 66 |
| | | Heated rear window | 172 |
| | | I dentification data | 341 |
| | | - bodywork paint identification plate..... | 342 |
| | | - chassis marking | 341 |
| | | - engine marking | 341 |
| | | - model plate | 341 |

| | | | | | |
|---|-----|---|----|--|-----|
| If a tyre is punctured (changing a wheel) | 274 | Key | 27 | - CID device | 44 |
| If an accident occurs | 308 | - actuation logic of the boot lock by means of the metal insert | 36 | - CID device battery replacement | 53 |
| - if anyone is injured | 308 | - actuation logic of the boot lock by means of the remote control | 35 | - door unlocking to access car..... | 49 |
| - first-aid kit | 309 | - automatically actuated functions..... | 37 | - knob for activating instrument panel and engine start-up | 47 |
| Ignition switch | 24 | - battery replacement | 38 | - failure indication | 52 |
| In an emergency | 271 | - functions that can be actuated with the metal insert of the key..... | 34 | - locking the door and leaving the car | 50 |
| Instrument dimmer | 172 | - remote control functions | 32 | - “Garage” position (emergency actuation) | 46 |
| Instrument panel | 105 | - request for additional keys with remote control.... | 39 | - ministerial homologation ... | 53 |
| Instruments | 107 | Keyless System (recognition system) | 44 | CID devices | 54 |
| Interior equipment | 212 | - Autoclose function | 50 | - system settings | 52 |
| Interiors (cleaning) | 339 | - bonnet opening | 50 | Kilometer counter and trip meter | 110 |
| “Isofix” child restraint system (presetting for mounting) | 85 | - central locking/opening of windows and sunroof..... | 51 | Kilometer counter and trip meter display..... | 110 |
| Jack | 276 | | | | |
| Jacking the car | 307 | | | | |
| - with an arm hoist or a shop jack | 307 | | | | |
| - with the jack | 307 | | | | |

| | | | | | |
|------------------------------|-----|-----------------------------------|-----|------------------------------------|-----|
| L ambda sensors | 6 | Manual gearbox | 179 | - towing a trailer | 211 |
| Lancia CODE (system) | 26 | - technical specifications | 348 | Performance | 358 |
| - CODE Card | 28 | Model plate | 341 | Power socket | |
| Levels (check) | 317 | MSR system | 192 | - in the boot | 234 |
| - brake and hydraulic | | Multifunction display | 110 | - in the rear armrest..... | 220 |
| clutch fluid | 323 | N umber plate lights | | Power steering fluid | 322 |
| - engine coolant..... | 321 | - bulb replacement | 287 | Pretensioners (seat belts) | 78 |
| - engine oil | 320 | O ddment compartment | 216 | R adar Cruise Control | 197 |
| - power steering fluid | 322 | Oddment compartment | | - controls | 198 |
| - windscreen/rear window | | on the dashboard | 218 | - failure indication | 207 |
| and headlight washer | | Outside mirror lights | | - general | 197 |
| fluid..... | 324 | - bulb replacement | 291 | Rain sensor | 102 |
| Light switch and | | P aper pockets | 221 | Rear armrest compartment..... | 219 |
| steering column stalks | 97 | Parking | 254 | Rear ceiling light | 213 |
| Load limiting devices | 79 | Parking lights | 97 | - bulb replacement | 288 |
| Lubricants | 364 | Parking sensor | 208 | Rear door safety lock | 58 |
| Luggage net (boot) | 231 | - failure indication | 211 | Rear fog lights | |
| M ain beam headlights | | - general warnings..... | 212 | - bulb replacement | 286 |
| - control | 100 | - sensors | 209 | - control | 171 |
| - to flash the lights | 100 | | | Rear seats | 66 |
| | | | | - armrests..... | 67 |

| | | | | | |
|--|-----|--|-----|--|-----|
| - Comfort Seats | 68 | - locking the door and leaving the car | 50 | S afe driving | 255 |
| - head restraints | 66 | - failure indication | 53 | - before getting behind the wheel..... | 255 |
| - heating | 67 | - “Garage” position (emergency actuation) | 46 | - driving at night | 257 |
| Rearview mirror lights | 214 | - locking the door and leaving the car | 50 | - driving in the fog | 258 |
| Rearview mirrors | | - ministerial homologation .. | 53 | - driving in the mountains | 258 |
| - external | 72 | - request for additional CID devices | 53 | - driving in the rain | 257 |
| - internal | 71 | - system settings | 52 | - driving on snow and ice | 259 |
| Recognition system | | Remote control (CONNECT) .. | 19 | - driving with ABS | 259 |
| (Keyless System) | 44 | Rev counter | 107 | - when travelling | 255 |
| - Autoclose function | 51 | Reverse lights | | Seat belts | |
| - bonnet opening | 50 | - bulb replacement | 286 | - front seat belt height adjustment | 77 |
| - central locking/opening of windows and sunroof..... | 52 | Rims | 354 | - general instructions | 79 |
| - CID device | 44 | - correct rim reading..... | 357 | - how to keep seat belts in proper working order..... | 80 |
| - CID device battery replacement | 54 | - important | 356 | - load limiting devices | 79 |
| - door unlocking to access car..... | 49 | Roof rack/ski rack..... | 240 | - pretensioners | 78 |
| - knob for activating instrument panel and engine start-up | 47 | - anchorage points..... | 240 | - use | 76 |
| | | Rubber tubing (maintenance) | 333 | Side/taillights | |
| | | | | - control | 97 |

| | | | | | |
|-----------------------------------|---------|---------------------------------|-----|--|---------|
| Ski tunnel | 234 | - JTD versions | 251 | - technical specifications | 170 |
| Snow chains | 268 | - jump starting..... | 272 | Suspensions | |
| Solar cell operated sunroof | 222 | - petrol versions | 251 | - technical specifications..... | 350 |
| - central locking/opening..... | 225 | Steering | | Symbols | 9 |
| - emergency manoeuvre..... | 226 | - technical specifications..... | 352 | T Technical specifications | 341 |
| - opening/closing | 223 | Steering column lock | 24 | Third brake light | 287 |
| - pivoting | 223 | Steering wheel..... | 70 | Tools | 275 |
| - solar cells | 226 | - controls | 18 | Towing a trailer | 264 |
| Sound system | 247 | - electric adjustment | 70 | - important | 264 |
| - Bose HI-FI sound system | 248 | - manual adjustment | 70 | - installation diagram | 265 |
| - speakers | 247 | Steering wheel stalks | 97 | - tow hitch installation | 265 |
| Spark plugs | | - left-hand stalk | 100 | Towing the car | 305 |
| - maintenance | 330 | - right-hand stalk | 101 | Transmission | |
| - type | 346 | Stopping the engine | 252 | - technical specifications..... | 348 |
| Speakers | 247 | Storing the car | 269 | Twilight sensor | 99 |
| Speedometer | 107 | - using the car again..... | 269 | Tyre inflation pressure | 354-384 |
| Starting the engine | 250 | Sun visors | 214 | - important | 331 |
| - bump starting | 273 | Supplementary heater..... | 162 | Tyres | |
| - emergency start-up..... | 253-271 | - operation with engine | | - changing a wheel | 274 |
| - engine stopping | 252 | running | 169 | - correct tyre reading | 356 |
| - engine warming up | 252 | - operation with engine | | - important | 332-356 |
| - ignition switch..... | 24 | stationary | 163 | | |

| | | | |
|--|-----|--------------------------------|---------|
| - maintenance | 331 | - fluid | 324 |
| - pressure (important) | 331 | Windscreen washer blades | |
| - winter tyres | 267 | - maintenance | 333 |
| U seful accessories | 270 | Windscreen wiper | |
| V olumetric protection | 41 | - blade maintenance | 333 |
| W arning lights and messages. 115 | | - control | 101 |
| Weights | 360 | Windscreen wiper spray nozzles | |
| Wheel geometry | 358 | (maintenance) | 334-335 |
| W heels | | | |
| - changing a wheel | 275 | | |
| - important | 332 | | |
| - inflation pressure | 354 | | |
| - pressure (important) | 331 | | |
| - technical specifications | 354 | | |
| - wheel geometry | 358 | | |
| Windscreen/rear window and | | | |
| headlight washer fluid | 324 | | |
| Windscreen washer | | | |
| - control | 101 | | |

PROVISIONS FOR THE PROCESSING OF A VEHICLE AT THE END OF ITS LIFE-CYCLE

For years now Lancia has been developing its global commitment towards the safeguarding and protection of the Environment through the continuous improvement of its production processes and the making of increasingly more “eco friendly” products. With a view to guaranteeing the best possible service to clients in full observance of environmental standards and in response to the obligations imposed by European Directive 2000/53/EC on end-of-life vehicles, Lancia offers its clients the possibility to hand in their vehicle* at the end of its life span without additional costs.

The European Directive, in fact, provides for the take-back of the vehicle without the last holder or owner of the same incurring expenses due to the fact that the market value of the vehicle is zero or negative. In particular, in almost all of the countries of the European Union, up until 1st January 2007, take-back of the vehicle free of charge only applies to vehicles registered from 1 July 2002 on, while, from 2007 on, take-back will be carried out free of charge, independently of the year of registration, provided that the vehicle still contains all its essential component parts (especially engine and body) and is free from additional waste materials.

Our contracted network of authorised treatment facilities has been carefully selected in order to provide a quality service to our customers by de-polluting and recycling “End of Life Vehicles” to approved environmental standards. To find out the location of your nearest authorised treatment facility, offering free of charge take-back, simply contact one of our dealers or refer to the Lancia web site or call the toll free number 00800 526242 00.

* Passenger transportation vehicles to seat a max. of nine persons, having a total admissible weight of 3.5 t

SELENIA®

At the heart of your engine.



Always ask your mechanic for **SELENIA®**

Oil change? The experts recommend Selenia.

*The engine of your car is factory filled with **Selenia**. This is an engine oil range which satisfies the most advanced international specifications. Its superior technical characteristics allow **Selenia** to guarantee the **highest performance** and **protection of your engine**.*

The Selenia range includes a number of technologically advanced products:

SELENIA PERFORMER MULTIPOWER

Particularly ideal for the protection of new generation petrol engines, very effective even in the most severe weather conditions. It guarantees a reduction in fuel consumption (Energy conserving) and it is also ideal for alternative engines.

SELENIA K

is the synthetic lubricant with innovative technology, which ensures improved cold starting for petrol engines and the utmost protection also under typically “urban” conditions of use. Owing to its 5W-40 viscosimetric grade and its special formulation it more effectively meets the emission limits required by new European regulations and exceeds the major international specifications.

SELENIA WR

Oil specifically designed for common rail Multijet engines. Particularly effective during cold starts, it guarantees maximum wear protection and hydraulic tappets control, reduction in consumption and stability at high temperatures.

SELENIA DIGITECH

Fully synthetic lubricant for petrol and diesel engines. Its advanced technology guarantees maximum protection, a reduction in consumption and reliability in extreme climate conditions.

The range also includes Selenia StAR, Selenia Racing, Selenia 20K Alfa Romeo, Selenia TD, Selenia Performer 5W-40
For further information on Selenia products visit the web site www.fliselenia.com.

COLD TYRE INFLATION PRESSURE (bar) (snow tyres excluded)

| | | 2.0 TB | 2.4 2.4 CAE | 2.4 JTD 20V CAE | 3.2 V6 CAE |
|----------------------|-----|---------------------|---------------------|---------------------|---------------------|
| Front and rear tyres | | 215/60 R16 95W | 215/60 R16 95W | 215/60 R16 95W | 215/60 R16 95W |
| | | 215/60 ZR16 95W | 215/60 ZR16 95W | 215/60 ZR16 95W | 215/60 ZR16 95W |
| | | 225/50 R17 94W (*) | 225/50 R17 94W (*) | 225/50 R17 94W (*) | 225/50 R17 94W (*) |
| | | 225/50 ZR17 94W (*) | 225/50 ZR17 94W (*) | 225/50 ZR17 94W (*) | 225/50 ZR17 94W (*) |
| Reduced load | bar | 2.3 | 2.3 | 2.3 | 2.3 |
| Full load | bar | 2.3 | 2.3 | 2.3 | 2.3 |

(*) Tyres that cannot be fitted with chains.

0.3 bar should be added to the values given if the pressure is measured while the tyre is hot.

ENGINE OIL CHANGE

| | | 2.0 TB | 2.4 - 2.4 CAE | 2.4 JTD 20V CAE | 3.2 V6 CAE |
|--|--------|--------|---------------|-----------------|------------|
| Engine oil (quantity for periodical replacement - sump and filter) | litres | 5.50 | 5.50 | 5.0 | 5.90 |

 Dispose of waste oil properly.

FUEL CAPACITIES

| | | 2.0 TB | 2.4 - 2.4 CAE | 2.4 JTD 20V CAE | 3.2 V6 CAE |
|---------------|--------|--------|---------------|-----------------|------------|
| Tank capacity | litres | 75 | 75 | 75 | 75 |
| Reserve | litres | 10 | 10 | 10 | 10 |

Refuel petrol engines with unleaded petrol with octane rating (RON) no lower than 95 only.

Refuel diesel engines with diesel fuel for motor vehicles (EN590 specifications) only.



Fiat Group Automobili S.p.A.
 Servizi al Cliente - Assistenza Tecnica - Ingegneria Assistenziale
 Largo Senatore G. Agnelli, 5 - 10040 Volvera - Torino (Italia)
 Print n. 603.81.230 - 09/2007 - 1st Edition



The data contained in this publication is intended merely as a guide. Lancia reserves the right to modify the models and versions described in this booklet at any time for technical and commercial reasons. If you have any further questions please consult your Lancia dealer.
Printed in recycled paper without chlorine.