

Musa

Owner Handbook



Dear Customer,

Congratulations on your choice of a LANCIA.

We have written this handbook to help you get to know all the features of your car and use it in the best possible way. You should read it right through before taking to the road for the first time.

You will find information, tips and important warnings regarding the driving of your car to help you derive the maximum from the technological features of your LANCIA. You will discover its features and details, along with essential information, advice and warnings for correct use, driving safety and maintenance of your LANCIA.

Read the warnings and indications, marked with the following symbols:



personal safety;



car safety;



environmental protection.

The attached Warranty Booklet lists the services that LANCIA offers to customers:

- the Warranty Certificate with terms and conditions for maintaining its validity
- the range of additional services available to LANCIA Customers.

We are sure that these will help you harmonise with your new car and further appreciate it and the care provided by the people at LANCIA.

Enjoy the road. Happy motoring!

**This Owner Handbook describes all the versions of the LANCIA Musa.
As a consequence, you should only consider the information which is related to the engine
and bodywork version of the car you have purchased.**

SAFETY AND PROTECTING THE ENVIRONMENT

Safety and respect for the environment have been the guidelines which have inspired LANCIA Musa design from the very start.

Thanks to this approach, LANCIA Musa has passed very stringent safety tests.

It is top in its class and is probably ahead of future models.

Furthermore, the continuous search for new, effective solutions for better environmental protection makes LANCIA Musa a model to be imitated also from this point of view.

All versions are equipped with environmental protection devices which abate harmful exhaust gas emissions well beyond the limits established by the laws in force.

PROTECTING THE ENVIRONMENT

The design and production methods of the LANCIA Musa have been developed with concern to the traditional performance and safety aspects, taking into account the increasingly more urgent issues related to environmental protection and conservation.

The chosen materials, techniques and devices are the result of a work which allows to drastically limit harmful effects on the environmental and comply with the strictest international standards.

USE OF ENVIRONMENTAL-FRIENDLY MATERIALS

All components of the LANCIA Musa are asbestos-free. Padding and the climate control system are free from CFC (chlorofluorocarbon), the gases deemed responsible for the destruction of the ozone layer. Paint and bolt corrosion protections are cadmium-free and safe for the air and water.

EMISSION REDUCTION DEVICES (petrol engines)

Three-way catalytic converter

The exhaust system is equipped with a catalyser made of noble metal alloys. It is accommodated in a stainless steel container which can withstand high operating temperatures.

The catalyser converts unburnt hydrocarbons, carbon oxide and nitrogen oxides contained in exhaust gases (the harmful gas content in exhaust is also limited by the electronic injection and ignition system), turning them into non-polluting compounds.

Due to the high temperature reached during operation of the catalytic converter, it is advisable not to park the car over flammable materials (paper, oil, dry grass, dry leaves, etc.).

Lambda sensors

The lambda sensors detect the oxygen content in exhaust gases. The signal transmitted by the lambda sensors is used by the injection and ignition system electronic control unit to adjust the air-fuel mixture.

Anti-evaporation system

It is impossible to prevent the formation of petrol vapours, even when the engine is off. For this reason, a system has been developed which traps the vapours in a special activate carbon canister.

The vapours are sucked in and burnt in the engine during operation.

EMISSION REDUCTION DEVICES (Multijet engines)

Oxidising catalytic converter

The device converts the polluting substances contained in exhaust gases (carbon oxide, unburnt hydrocarbons and particulate) into harmless substances, reducing the smokiness and the typical smell of diesel engines.

The catalytic converter consists of a stainless steel metallic casing which contains a wasp nest ceramic body on which the noble metal used for the catalysing action is applied.

Exhaust gas recirculation system (E.G.R.)

This device recirculates (i.e. reuses) part of the exhaust gases. The percentages depends on the conditions of use of the engine.

It is used to control nitrogen oxide emissions, when needed.

VERY IMPORTANT

REFUELLING



Petrol engines: refuel with unleaded petrol with an octane rating (RON) of 95 or higher only.



Multijet engines: only refuel with diesel fuel conforming to the European specification EN590.

The use of other products or mixtures may damage the engine beyond repair and consequently cause lapse of warranty in relation to the damage caused.

STARTING THE ENGINE



Petrol engines: make sure that the handbrake is engaged; set the gearshift lever to neutral; fully depress the clutch without pressing the accelerator, then turn the ignition key to **AVV** and release it as soon as the engine has started.

Multijet engines: Turn the ignition key to **MAR** and wait for the warning lights  e  to go out; turn the ignition key **AVV** and release it as soon as the engine starts.

PARKING ON FLAMMABLE MATERIAL



The catalytic converter develops high temperature during operation. Do not park on grass, dry leaves, pine needles or other flammable material: fire risk.

RESPECTING THE ENVIRONMENT



The car is fitted with a system that allows continuous diagnosis of the components correlated with emissions to ensure better respect for the environment.

ELECTRIC ACCESSORIES

If, after buying the car, you decide to add electric accessories (that will gradually drain the battery), visit a **Lancia Dealership**. They can calculate the overall electric requirement and check that the car's electric system can support the required load.



CODE card

Keep the card in a safe place, non in the car. Have the electronic code printed on the CODE card with you at all times. You will need it to start the engine in an emergency.

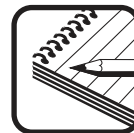



SCHEDULED SERVICING

Correct maintenance of the car is essential for ensuring it stays in tip-top condition and safeguards its safety features, its environmental friendliness and low running costs for a long time to come.



THE OWNER'S HANDBOOK CONTAINS...

... important information, advice and warnings for correct use, driving safety and maintenance of your car in time. Pay special attention to the symbols  (personal safety)  (environmental protection)  (car integrity).

Refer to the “Warning lights and messages” chapter in this handbook if the message “see Handbook” appears on the display.



DASHBOARD AND CONTROLS

DASHBOARD.....	8	FUEL CUT OFF SWITCH.....	72
INSTRUMENT PANEL.....	10	INTERIOR EQUIPMENT	73
SYMBOLS	11	SMOKER'S KIT	75
THE LANCIA CODE SYSTEM.....	11	SUN VISORS	76
KEY KIT AND DOOR LOCKING SYSTEM	13	SUNROOF	76
IGNITION SWITCH	20	WINDOW WINDERS	78
INSTRUMENTS	21	BOOT	80
MULTIFUNCTIONAL DISPLAY (ON TWO-LINE MODAL PANEL).....	22	BONNET	82
MULTIFUNCTIONAL DISPLAY (ON THREE-LINE COMFORT PANEL)	25	ROOF RAILS	83
ADJUSTING THE SEATS	38	HEADLIGHTS	84
HEAD RESTRAINTS	44	ABS SYSTEM	85
ADJUSTING THE STEERING WHEEL	45	EOBD SYSTEM	86
REAR VIEW MIRRORS	46	GSI SYSTEM.....	87
CLIMATE CONTROL SYSTEM	47	SOUND SYSTEM	87
MANUAL CLIMATE CONTROL SYSTEM	48	ACCESSORIES PURCHASED BY THE OWNER .	88
AUTOMATIC TWO-ZONE CLIMATE CONTROL SYSTEM.....	52	“DUAL DRIVE” ELECTRIC POWER STEERING SYSTEM	89
EXTERNAL LIGHTS	62	PARK SENSOR	90
CLEANING THE WINDOWS	64	REFUELLING	92
CRUISE CONTROL	67	PROTECTING THE ENVIRONMENT	94
CEILING LIGHTS	69		
LIGHT CONTROL BUTTONS	71		

DASHBOARD

The presence and position of the controls, instruments and gauges may vary depending on the version.

There are several solutions for the central upper and lower console according to the chosen customisations: see the following figures.

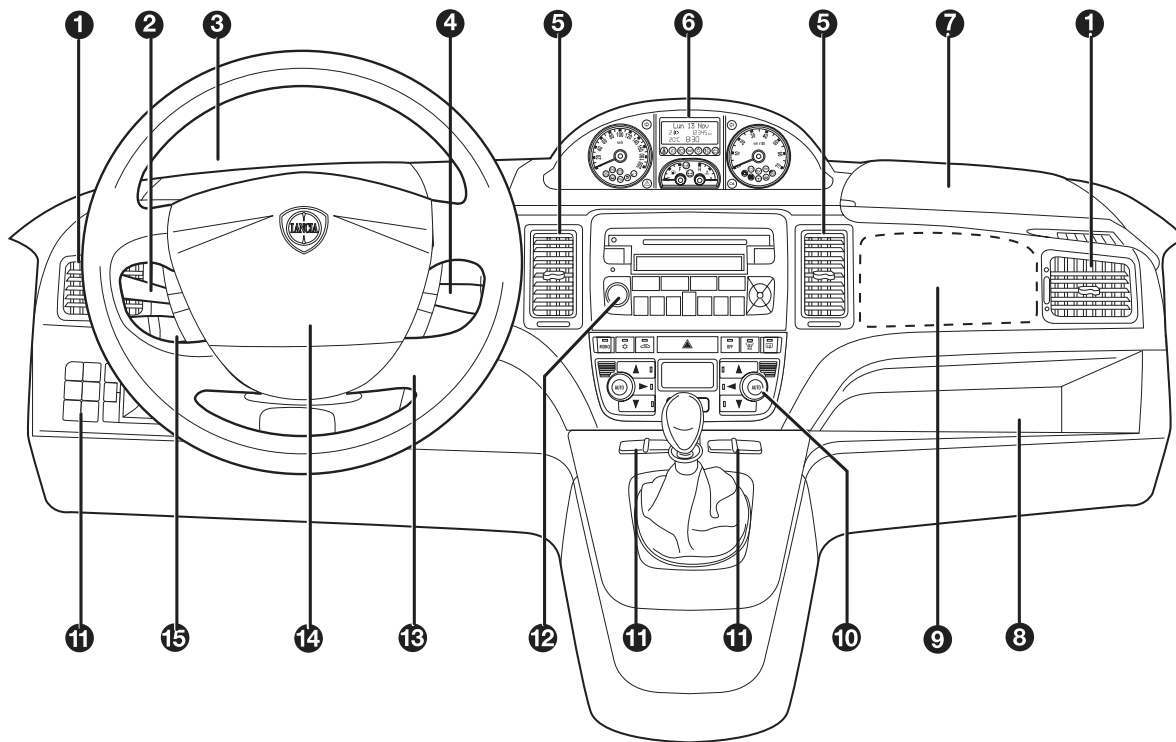

fig. 1

1. Side air vents - 2. Left stalk- 3. Left upper box - 4. Right stalk - 5. Central air vents - 6. Instrument panel - 7. Right upper box - 8. Oddment compartment 9 Passenger airbag - 10. HVAC controls - 11. Control buttons 12 Sound system (for versions/markets, where provided) - 13. Ignition switch - 14. Driver airbag - 15. Cruise control (for versions/markets, where provided).

L0D0374m

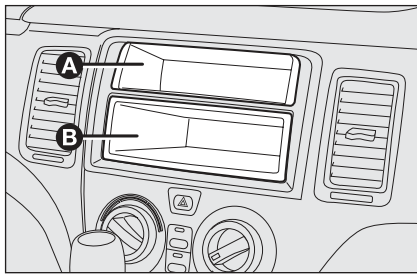

fig. 2

L0D0231m

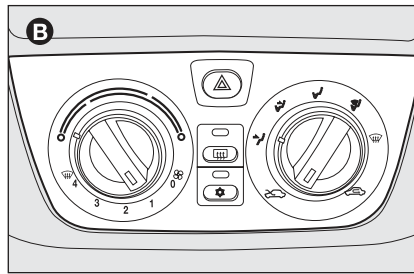

fig. 5

L0D0234m

Upper central console:

- with fixed oddment compartment **A-fig. 2** and extractable component (DIN) **B-fig. 2** for installing the sound system;
- with sound system **fig. 3**.
- with Connect Nav+ **fig. 4**.

Lower central console:

- with manual climate control system **B-fig. 5**;
- with two-zone automatic climate control system **C-fig. 6**.

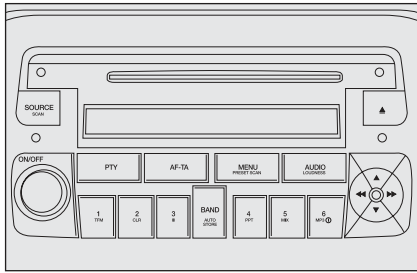

fig. 3

L0D0232m

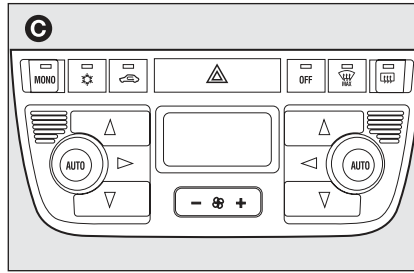

fig. 6

L0D0235m

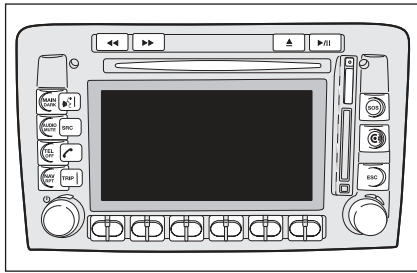



fig. 4

L0D0359m

INSTRUMENT PANEL

Modal fig. 7

- A – Speedometer
- B – Fuel level gauge with reserve warning light
- C – Engine coolant temperature gauge and hot engine coolant warning light
- D – Rev counter
- E – Multifunctional display

  Warning lights for Multijet versions only

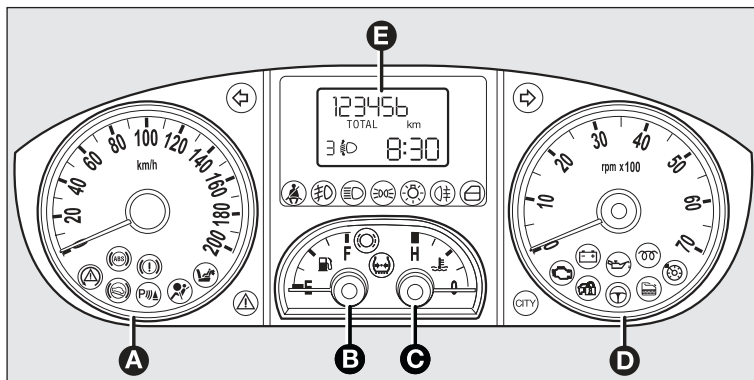



fig. 7

L0D0372m

Comfort fig. 8

- A – Speedometer
- B – Fuel level gauge with reserve warning light
- C – Engine coolant temperature gauge and hot engine coolant warning light
- D – Rev counter
- E – Reconfigurable multifunctional display

  Warning lights for Multijet versions only

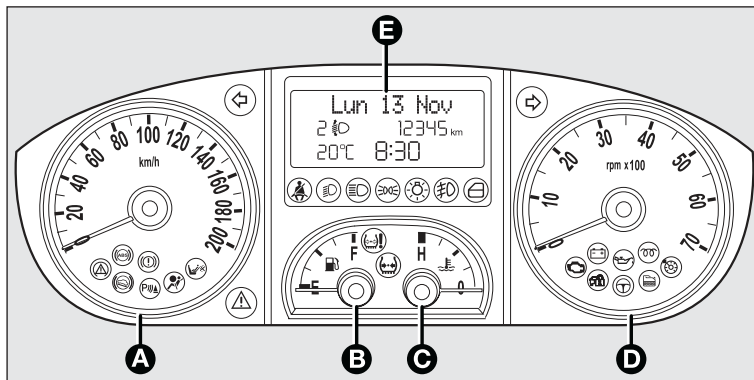

fig. 8

L0D0010m

SYMBOLS

Special coloured labels have been attached near or actually on some of the components of your car. These labels bear symbols that remind you of the precautions to be taken as regards that particular component.

The plate summarising the symbols used can be found under the bonnet **fig. 9**.

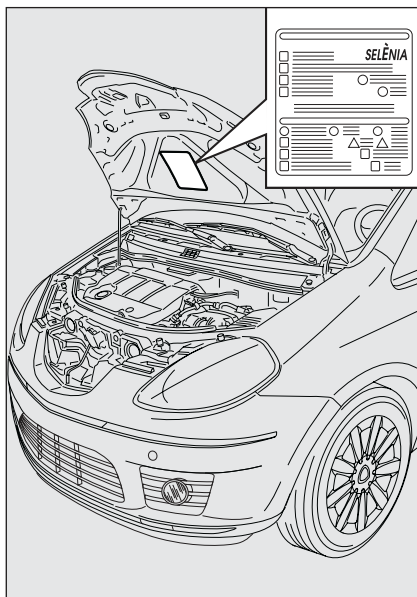

fig. 9

L0D0375m

THE LANCIA CODE SYSTEM

This is an electrical engine locking system which increases protection from attempted theft of the car. It is automatically activated when the ignition key is extracted.

Each key contains an electronic device which modulates the signal emitted during ignition by an antenna incorporated in the ignition device. This signal is the 'password' which changes at each ignition and which the control unit uses to recognise the key and allow ignition.

DASHBOARD
AND
CONTROLS

SAFETY

STARTING
AND DRIVING

WARNING
LIGHTS AND
MESSAGES

IN AN
EMERGENCY

MAINTENANCE
AND CARE

TECHNICAL
SPECIFICA-
TIONS

INDEX

OPERATION

Each time the car is started turning the ignition key to **MAR**, the Lancia CODE system control unit sends a recognition code to the engine control unit to activate the functions. The code is sent only if the Lancia CODE system control unit has recognised the code transmitted from the key. Each time the ignition key is turned to **STOP**, the Lancia CODE system deactivates the functions of the engine electronic control unit.

If the code has not been recognised correctly, the warning light  turns on on the display.

In this case, turn the key to **STOP** and then back to **MAR**; try with the other keys provided if the problem persists. Contact a Lancia Dealership if you still cannot start the engine.

IMPORTANT Each key has its own code which must be stored by the system electronic control unit. Contact a Fiat Dealership to have new keys (up to eight) stored.

Warning light coming on when driving

- If the warning light  turns on, this means that the system is running a self-test (for example for a voltage drop).
- If the fault persists, contact a Lancia Dealership.



The electronic components inside the key may be damaged if the key is submitted to sharp knocks.

KEY KIT AND DOOR LOCKING SYSTEM

CODE CARD Fig. 10
(for versions/markets, where provided)

The car is delivered the keys and a CODE card which bears the following information:

- ❑ the mechanical key code **B** to be given to the Lancia Dealership when ordering duplicate keys.

IMPORTANT In order to ensure perfect efficiency of the electronic devices contained inside the keys, they should never be exposed to direct sunlight.



All the keys and the CODE card must be handed over to the new owner when selling the car.

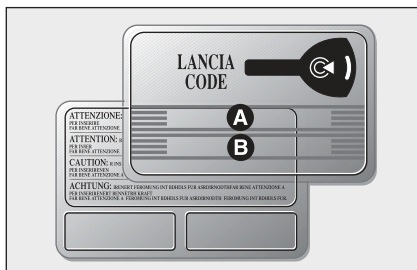

fig. 10

L0D0376m

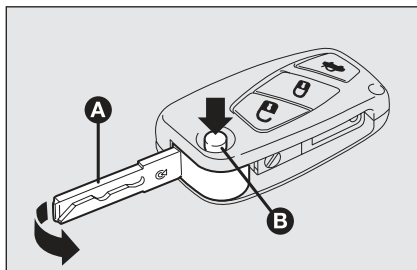

fig. 11a

L0D0377m

MAIN KEY WITH REMOTE CONTROL fig. 11

The metal insert of the key **A** retracts into the grip.

The key operates:

- ❑ the ignition switch;
- ❑ the door lock on drive side;
- ❑ operation of the emergency front and rear door lock release system **D**-fig. 12 from the outside for use the electric system is not working (e.g. flat battery);

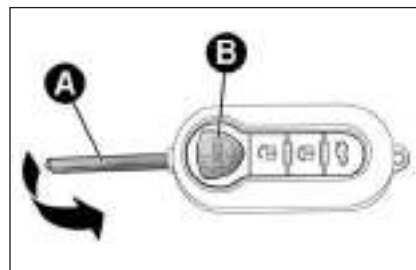

fig. 11b (for versions/markets, where provided)

L0D0491m

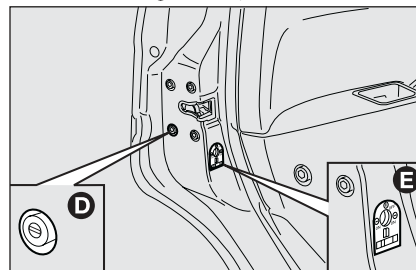

fig. 12

L0D0246m

- ❑ operation of the child lock **E**-fig. 12 on rear doors.

Press button **B**-fig. 11 to open the metallic part **A**.

To insert the metallic part **A** back in the grip:

- hold button **B** pressed
- move the metallic part **A**
- release button **B** and then turn the metal insert **A** until it clicks.

Button  is used to open the doors, tailgate and fuel flap (where provided).

Button  is used to lock the doors, tailgate and fuel flap (where provided).

Button  is used for remote opening the tailgate.



WARNING

*Only press button **B** with the key away from your body; specifically from your eyes and from objects which could get damaged (e.g. your clothes). Do not leave the key unattended, because someone, a child especially, may accidentally press the button while handling the key.*

Unlocking the doors and the tailgate

Press button  briefly: this will release the doors, the tailgate, the fuel flap; the internal ceiling light will come on and the direction indicators will blink twice.

The doors are automatically unlocked when the fuel inertia switch trips.

By using the “Setup Menu” of the multifunctional display (see the specific paragraph in the “Dashboard and controls” chapter), the system can be set so that only the driver’s door is unlocked when button  is pressed.

IMPORTANT Powerful radio transmissions not related to the car (e.g. mobile phones, amateur radios, etc.) may interfere with the frequency of the remote control. Remote control operation may be impaired.

Unlocking the doors and the tailgate

Press button  briefly: this will release the doors, the tailgate, the fuel flap; the internal ceiling light will come on and the direction indicators will blink twice.

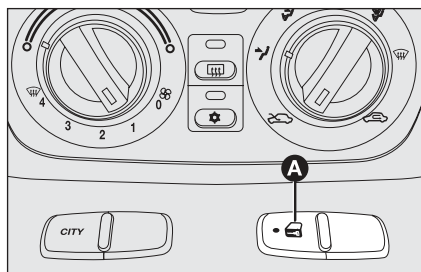

fig. 13

L0D0417m

Deterrent LED indications

When locking the doors, the deterrent LED on the button **A-fig. 13** lights up for about 3 seconds and then starts flashing (deterrence function). Once doors are locked, if one or more doors or the tailgate are not closed correctly, the led and direction indicators start flashing quickly.

IMPORTANT Strong radio transmission outside the vehicle (e.g. mobile phones, amateur radios, etc.) may interfere with the frequency of the remote control. Remote control operation may be impaired.

Opening the tailgate with the remote control

Hold button  pressed to unlock (open) the tailgate. The opening of the tailgate is signalled by the direction indicators flashing twice; when it is closed there is one flash.

IMPORTANT Strong radio transmission outside the vehicle (e.g. mobile phones, amateur radios, etc.) may interfere with the frequency of the remote control. Remote control operation may be impaired.

Door locking from the inside

With the doors closed, press button **A-fig. 13** on the central dashboard to lock or unlock the doors.

IMPORTANT If the door is not correctly closed or if a fault is present in the system, the door locking device from inside the car will not work.

The device will resume normal operation after removing the cause of the fault.



Only the doors used to get out of the car will be unlocked if the door lock button inside the car is pressed by mistake. The tailgate will remain locked. Press the lock/unlock buttons to realign the system.

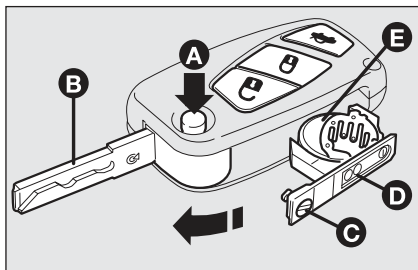

fig. 14a

L0D0379m

Replacing the remote control battery Fig. 14

To replace the battery, proceed as follows:

- press button **A** and open the metal insert **B**;
- turn the screw **C** to using a fine bit screwdriver;
- take out the battery case **D** and replace the battery **E** respecting its polarity;
- refit the battery case **D** inside the key and lock it by turning the screw **C**.

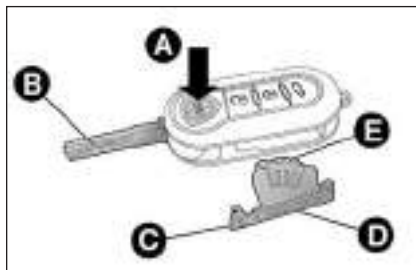
fig. 14b (for versions/markets, where ^{L0D0492m} provided)

Request for additional remote controls

The system may recognise up to 8 remote controls. Should a new remote control be necessary, contact a Lancia Dealership, taking with you the CODE card, a personal identity document and the car's ownership documents.



Used batteries are harmful to the environment. They should be disposed of as specified by law in the special containers provided, or take them to the Lancia Dealership, which will deal with their disposal.

MECHANICAL KEY (SPARE) fig. 15

The metal insert of the key **E**-fig. 15 is fixed.

The key operates:

- the ignition switch;
- the door lock on drive side;
- operation of the door safety device in case of electric system failure (e.g. flat battery);
- operation of the child lock on rear doors.

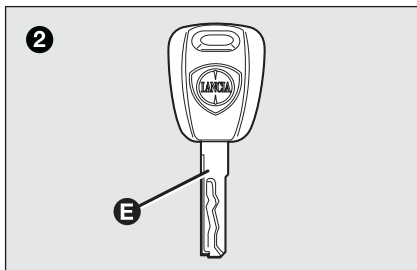

fig. 15

L0D0380m



WARNING

Only press button B with the key away from your body, specifically from your eyes and from objects which could get damaged (e.g. your clothes). Do not leave the key unattended, because someone, a child especially, may accidentally press the button while handling the key.

Changing the remote control cover fig. 16

(for versions/markets, where provided)

Proceed as shown in the figure to replace the remote control cover.

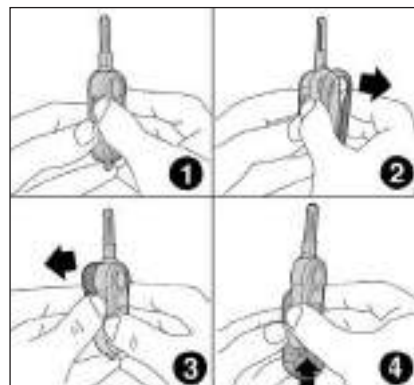



fig. 16

L0D0380m

The main functions that can be activated with the keys (with or without remote control) are the following:

Type of key	Unlocking the doors	Locking the doors from the outside	Unlocking the tailgate
Spare mechanical key	Turn key anticlockwise (driver's side)	Turn key clockwise (driver's side)	
Main key with remote control	Turn key anticlockwise (driver's side)	Turn key clockwise (driver's side)	
	Press briefly button 	Press briefly button 	Hold pressed button  (for longer than two seconds)
Direction indicators flash (for key with remote control only)	2 blinks	blinks once	2 blinks
Deterrence led	Turning off	Steady for approximately 3 seconds and then deterrent blinking	Deterrence led

Press button  to open the fuel flap.

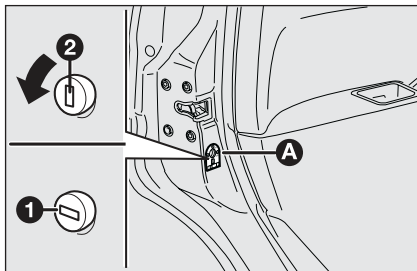

fig. 17

L0D0101m

CHILD LOCK fig. 17

To prevent opening the rear doors from the inside.

This device can be engaged only with rear doors open.

- position 1 - device on (door locked);
- position 2 - device off (door can be opened from the passenger's compartment).

The device A stays on even if the doors are unlocked by the centralised system.

IMPORTANT Always use this device when transporting children.

IMPORTANT After engaging the child lock on both rear doors, check for proper engagement by trying to open a rear door with the internal handle.



WARNING

Operation of the child lock A-fig. 19 is only guaranteed if the lock is turned and snaps into horizontal position 1.



WARNING

Release of the child lock A-fig. 17 is only guaranteed if the lock is turned and snaps into the vertical position 2.

EMERGENCY DOOR UNLOCKING DEVICE fig. 18

The doors are provided with a device for locking all the door using the lock in case of a power fault.

Proceed as follows to lock the doors:

- insert the ignition key in lock B
- turn the device to position 1 and close the door.

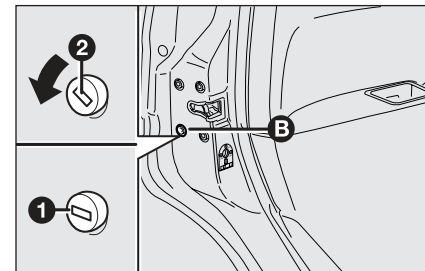

fig. 18

L0D0247

To reopen the doors:

- insert the key in the lock on driver's side and turn it anticlockwise
- open the driver's door
- operate the door levers from the inside of the vehicle for the remaining doors.



WARNING

Do not operate the child lock and the door handle at the same time.

IGNITION SWITCH

The key can be turned to 3 different positions:

- STOP**: engine off, key extractable, steering locked. Some electric devices (e.g. sound system, central door locking system, etc.) may work.
- MAR**: driving position. All electric devices may work.
- AVV**: engine starting (unstable position).

The ignition switch is fitted with a safety system that, in the event the engine is not started, turns back the ignition key to **STOP** before repeating the starting operation.

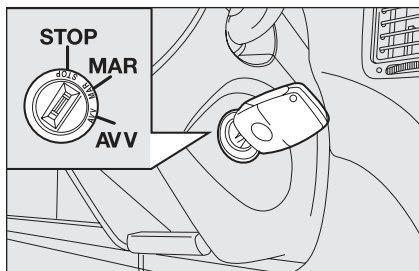

fig. 19

L0D0021m



WARNING

Under no circumstances should aftermarket operations involving steering system or steering column modifications (e.g.: installation of alarm) be carried out that could badly affect performance and safety. This also causes the warranty to become null and void and results in vehicle non-compliance with type-approval requirements.



WARNING

If the ignition device is tampered with (e.g.: attempted theft), have it checked over by a Lancia Dealership as soon as possible.



WARNING

Always remove the key when you leave your car to prevent someone from accidentally operating the controls. Remember to apply the handbrake. Engage first gear if the car is parked uphill or reverse if the car is parked downhill. Never leave children unattended in the car.

STEERING LOCK

Engagement

When the key is in position **STOP**, remove the key and turn the steering wheel until it is locked.

Switching off

Rock the steering wheel slightly as you turn the ignition key to **MAR**.



WARNING

Never extract the key while the vehicle is moving. The steering wheel would be locked as soon as the steering wheel is turned. This also applies to when the car is towed.

INSTRUMENTS

SPEEDOMETER Fig. 20

This indicates the vehicle speed.

REV COUNTER Fig. 21

This indicates the engine revolution per minute.

IMPORTANT The electronic injection control system gradually shuts off the flow of fuel when the engine is ‘over-revving’ resulting in a gradual loss of engine power.

When the engine is idling, the rev counter may indicate a gradual or sudden increase of the speed.

This is normal and does not indicate a fault. It may be caused, for example, by the operation of the climate control system or fan. In these case, a slow change in engine speed is used to protect the battery charge.

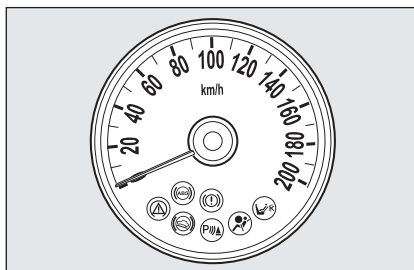

fig. 20

L0D0241m

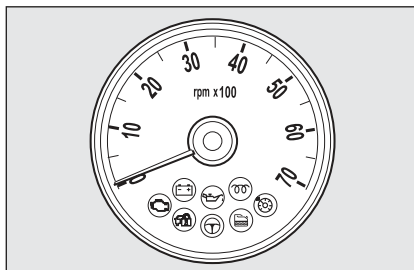

fig. 21

L0D0242m

FUEL LEVEL GAUGE Fig. 22

The instrument shows the litres of fuel contained in the tank (see the “Refuelling” paragraph for a description).

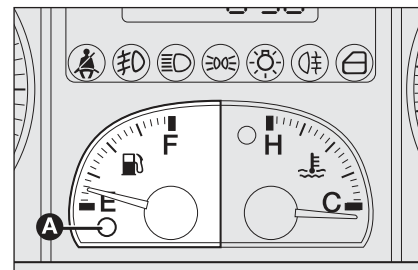

fig. 22

L0D0023m

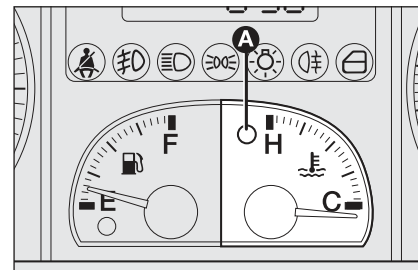

fig. 23

L0D0024m

The reserve warning light A turns on to indicate that approximately 6 litres of fuel are left in the tank.

Do not travel with the tank nearly empty: lack of fuel supply could damage the catalyser.

ENGINE COOLANT TEMPERATURE GAUGE fig. 23

Warning light **A** indicates overheating of the engine coolant. In this case, stop the engine and contact a Lancia Dealership. This shows the temperature of the engine coolant fluid and starts working when the fluid temperature exceeds approx. 50°C. In normal conditions, the needle may point to different positions according to use and the engine cooling system management.

IMPORTANT The needle will point to the lowest value of the scale (low temperature) and warning light **A** will light up to indicate a fault in the system. Go to a Lancia Dealership to have the system checked.



If the needle reaches the red area, stop the engine immediately and contact a Lancia Dealership.

MULTIFUNCTIONAL DISPLAY (on two-line modal panel)

The car can be equipped with the multifunction display for showing useful information necessary when driving according to settings.

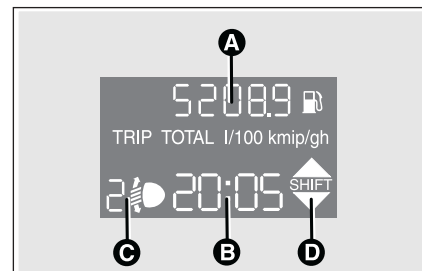

fig. 24

LOD0497m

“STANDARD” SCREEN fig. 24

The standard screen shows the following information:

- A** Odometer (kilometres or miles travelled)
- B** Clock (always displayed, even with key extracted and front doors closed)
- C** Headlight adjustment (only with dipped beam headlights on)
- D** Gear shift suggestion.

NOTE When opening one of the front doors, the display will turn on and show for a few seconds the clock and the kilometres or miles covered.

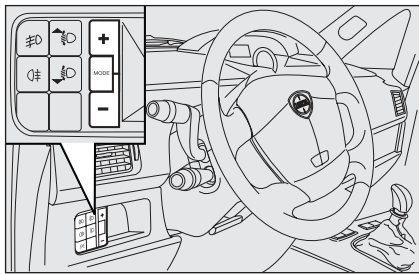

fig. 25

CONTROL BUTTONS fig. 25

+ To scroll the menu and the next options or to increase the displayed value.

MODE Press briefly to access the menu and/or go to next screen or to confirm the required menu option.

Hold pressed to go back to the standard screen.

- To scroll the menu and the previous options or to decrease the displayed value.

NOTE Buttons **+** and **-** activate different functions according to the following situations.

SET-UP MENU

The “Set-up Menu” is used for the following adjustments and/or settings:

- SETTING THE CLOCK
- SETTING THE BUZZER VOLUME
- SETTING THE SPEED LIMIT
- SETTING THE UNIT OF MEASUREMENT.

Setting the clock

The clock is set to 24 hours when the car is delivered.

Proceed as follows to set the required time:

- repeatedly press **MODE** to display “Hour”;
- press **+** to increase one minute;
- press **-** to decrease one minute;

Hold buttons **+** or **-** pressed for a few seconds to run the clock forwards or backwards rapidly until the buttons are released.

- Hold button **MODE** pressed for longer than two seconds to confirm the change made to the time.

Setting the buzzer volume

To set the desired volume, proceed as follows:

- repeatedly press **MODE** to display “BUZZ”;
- press **+** to increase the volume;
- press **-** to decrease the volume;
- Hold button **MODE** pressed for longer than two seconds to confirm the change made.

Setting the speed limit

A speed limit can be set and the system will inform the driver when the limit is exceeded by means of an indication on the display and the buzzer. Proceed as follows to set:

This function is “**OFF**” when the car is delivered.

Proceed as follows to select:

- repeatedly press **MODE** until “**SPEEd**” appears;
- press **+** to increase the value corresponding to speed (the maximum limit is 250 km/h);
- press **-** to decrease the value corresponding to speed (the limit is 30 km/h under which it switches to “OFF”);
- to confirm the setting, hold button **MODE** pressed for longer than two seconds.

Setting the unit of measurement

Proceed as follows to set the required unit of measurement (kilometres or miles):

- repeatedly press **MODE** to display **Unit**;
- press button **+** or **-** to change the unit of measurement;
- to confirm the setting, hold button **MODE** pressed for longer than two seconds.

Fuel inertia switch tripped indication

The indication appears automatically if the fuel inertia switch trips follow a collision of considerable severity.

The switch cuts off fuel feed.

See the “Fuel inertia switch” chapter for more information.



WARNING

If after the “FPson” message appears, you smell fuel or see leaks from the fuel system, do not reset the switch to avoid fine risk.

MULTIFUNCTIONAL DISPLAY (on three-line comfort panel)

The car can be equipped with the multifunction display for showing useful information necessary when driving according to settings.

“STANDARD” SCREEN fig. 26

The standard screen shows the following information:

- A Date / Odometer (covered km or miles).
- B Clock (always displayed, even with ignition key removed and front doors closed).
- C External temperature.

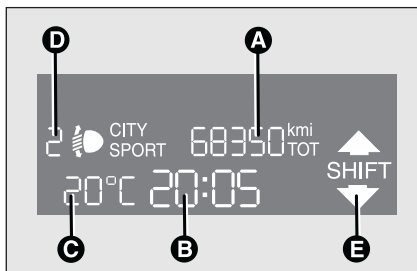

fig. 26

L0D0496m

D Headlight adjustment (only with dipped beam headlights on).

E Gear shift suggestion.

NOTE When opening one of the front doors, the display will turn on and show for a few seconds the clock and the kilometres or miles covered.

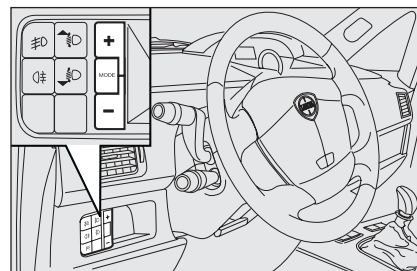

fig. 27

L0C0384m

CONTROL BUTTONS fig. 27

+ To scroll the menu and the next options or to increase the displayed value.

MODE Press briefly to access the menu and/or go to next screen or to confirm the required menu option.

Hold pressed to go back to the standard screen.

- To scroll the menu and the previous options or to decrease the displayed value.

NOTE Buttons **+** and **-** activate different functions according to the following situations.

Headlight adjustment (only with dipped beam headlights on).

– when the standard page is displayed, this is used to adjust the headlights (see the “Headlights” paragraph in this chapter).

Set-up menu

– for scrolling the menu up and down;
– to increase or decrease values during settings.

SET-UP MENU Fig. 28

The menu comprises a series of functions arranged in a “circular fashion” which can be selected through buttons **+** and **–** to access the different select operations and settings (setup) given in the following paragraphs.

The setup menu is activated by pressing briefly button **MODE**.

Single presses on buttons **+** and **–** will scroll the setup menu options.

Handling modes are different according to the characteristic of the option selected.

NOTE Only the following functions can be adjusted/set on the Instrument Panel display if the Connect Nav+ system is present: “Lights”, “Speed limit”, “Light sensor” (for versions/markets, where provided), “Belt buzzer” and “Passenger airbag”. The other functions are shown on the Connect Nav+ system display. Set and adjustment them there.

Selecting a menu option

– briefly press button **MODE** to select the menu option that needs to be changed.

– press buttons **+** and **–** (by single presses) to select the new setting;

– briefly press button **MODE** to store the new setting and at the same time go back to the previously selected menu option.

Selecting “Date” and “Clock”:

– briefly press button **MODE** to select the first value to be changed (e.g. hours /minutes or year / month / day).

– press buttons **+** and **–** (by single presses) to select the new setting;

– briefly press button **MODE** to store the new setting and go to the next setup menu option: if this is the last one you will go back to the previously selected option of the main menu.

Hold the button MODE pressed to:

– quit set-up and to save only the changes stored by the user (and confirmed by pressing button **MODE**).

The setup menu environment is timed. Only the changes saved by the user by briefly pressing **MODE** will be saved when the menu is automatically closed.

Example:

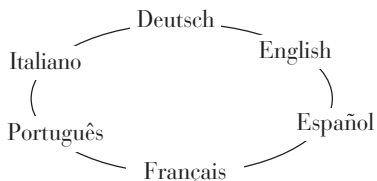

On the standard screen, briefly press **MODE** to start browsing. Press + or - browse within the menu.
NOTE Only the short menu may be accessed for reasons of safety while the car is moving (“Brightness” and “Speed Limit”). Stop the car to access the full menu. On car equipped with Connect Nav+, many functions are displayed on the navigator readout.

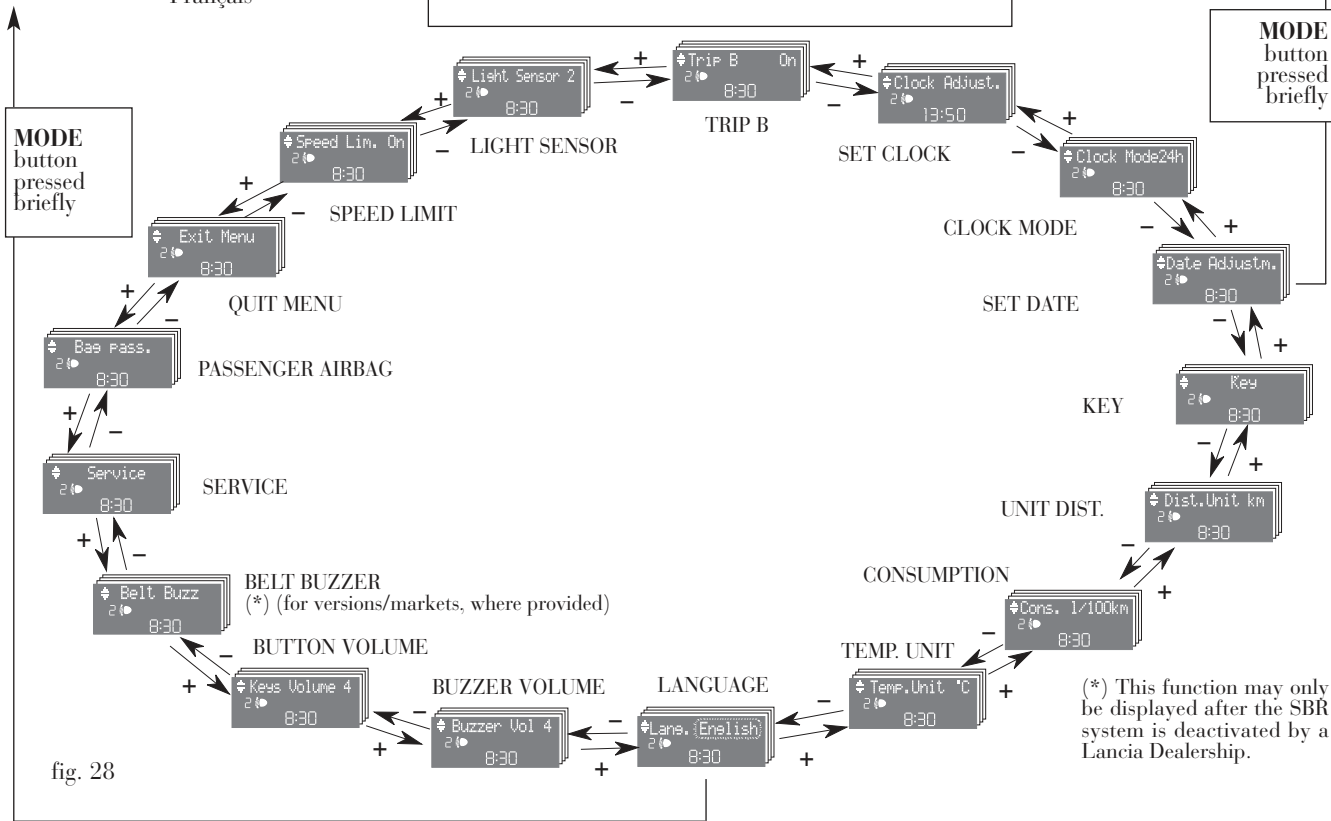

Example:

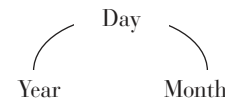

MODE
button
pressed
briefly

(* This function may only be displayed after the SBR system is deactivated by a Lancia Dealership.

- DASHBOARD AND CONTROLS
- SAFETY
- STARTING AND DRIVING
- WARNING LIGHTS AND MESSAGES
- IN AN EMERGENCY
- MAINTENANCE AND CARE
- TECHNICAL SPECIFICATIONS
- INDEX

fig. 28

Speed limit

This function is used to set the car speed limit (km/h or mph); the driver is immediately alerted when this limit is exceeded (see section “Warning lights and messages”).

To set the desired speed limit, proceed as follows:

- briefly press **MODE**, the message (speed limit) will appear on the display.
- press button **+** or **-** to select speed limit activation (On) or deactivation (Off);

– if the function has been activated (On), press buttons **+** or **-** to select the required speed limit and then press **MODE** to confirm.

NOTE The speed may be set in the range from 30 to 250 km/h, or from 20 to 155 mph according to the previously chosen unit (see “Setting the distance unit”) described below. The setting will increase/decrease by five units each time button **+** / **-** is pressed. Hold button **+** / **-** pressed to increase/decrease the setting rapidly. Complete the setting by briefly pressing the button when you approach the required setting.

– briefly press button **MODE** to go back to the menu screen or hold the button pressed to go back to the standard screen without storing the settings.

To cancel the setting, proceed as follows:

- briefly press button **MODE**: (On) will flash on the display;
- press button **+**: (Off) will flash on the display;
- briefly press button **MODE** to go back to the menu screen or hold the button pressed to go back to the standard screen without storing the settings.

Adjusting the automatic headlight sensor sensitivity (light sensor)

(for versions/markets, where provided)

This function is used to adjust the dusk sensor sensitivity to three levels (level 1 = minimum, level 2 = medium, level 3 = maximum); higher the sensitivity, lower the quantity of external light needed to switch the headlights on. The device is set to level “2” when the car is delivered.

Proceed as follows to set:

- briefly press button **MODE**, the previously set level will flash on the display;
- press button + or – for setting;
- briefly press button **MODE** to go back to the menu screen or hold the button pressed to go back to the standard screen without storing the settings.

Turning Trip B on/off (Trip B)

This function may be used to activate (On) or deactivate (Off) the Trip B (partial trip).

For further information see “Trip computer”.

Proceed as follows to turn on and off:

- briefly press **MODE ON** or **OFF** flashes on the display (according to the previous setting);
- press button + or – for setting;
- briefly press button **MODE** to go back to the menu screen or hold the button pressed to go back to the standard screen without storing the settings.

Setting the clock (Set clock)

This function is used to set the clock.

To carry out the adjustment, proceed as follows:

- briefly press button **MODE**: the “hours” will flash on the display;
- press button + or – to set;
- briefly press button **MODE**: “minutes” will start flashing on the display;
- press button + or – to set;

NOTE The setting will increase or decrease by one unit each time + or – is pressed. Hold the button pressed to increase/decrease the setting rapidly. Complete the setting by briefly pressing the button when you approach the required setting.

- briefly press button **MODE** to go back to the menu screen or hold the button pressed to go back to the standard screen without storing the settings.

12h/24h clock mode

This function is used to select 12h or 24 h display.

To carry out the adjustment, proceed as follows:

- briefly press **MODE**: either 12h or 24h will start flashing on the display (according to the previous setting);
- press button **+** or **-** for setting;
- briefly press button **MODE** to go back to the menu screen or hold the button pressed to go back to the standard screen without storing the settings.

Set date

This function is used to set the date (year – month – day).

Proceed as follows to update:

- briefly press button **MODE**: “year” will start flashing on the display;
- press **+** or **-** to adjust;

– briefly press **MODE**: “month” will start flashing on the display;

– press button **+** or **-** to set;

– briefly press button **MODE**: “day” will start flashing on the display;

– press button **+** or **-** to set.

Note The setting will increase or decrease by one unit each time **+** or **-** is pressed. Hold the button pressed to increase/decrease the setting rapidly. Complete the setting by briefly pressing the button when you approach the required setting.

– briefly press button **MODE** to go back to the menu screen or hold the button pressed to go back to the standard screen without storing the settings.

Unlocking the doors and the tailgate (key)

This function is used to: unlock the front and rear doors, unlock the driver’s side door or all the doors including the tailgate.

Proceed as follows to set:

– briefly press button **MODE**: “Open doors”, “Open driver”, “Open all”;

– press button **+** or **-** to select. The selected item will blink.

– briefly press button **MODE** to go back to the menu screen or hold the button pressed to go back to the standard screen without storing the settings.

“Distance” unit of measure

This function is used to set the unit of measure for distance (kilometres or miles)

Proceed as follows to set the required unit:

- briefly press **MODE**: (km) or (mi) will start blinking on the display (according to the previous setting);
- press button **+** or **-** for setting;
- briefly press button **MODE** to go back to the menu screen or hold the button pressed to go back to the standard screen without storing the settings.

“Consumption” unit of measure

This function is used to set the unit of measure for fuel consumption (km/l, l/100 km or mpg) according to the unit of measure selected in the previous paragraph (“Distance” unit of measure).

If the distance unit set is “km” the fuel consumption unit will be displayed in km/l or l/100km. If the distance unit set is “mi” the fuel consumption unit will be displayed in “mpg”.

Proceed as follows to set:

- briefly press **MODE**: (km/l) or (l/100km) will start flashing on the display (according to the previous setting);
- press button **+** or **-** for setting;
- briefly press button **MODE** to go back to the menu screen or hold the button pressed to go back to the standard screen without storing the settings.

“Temperature” unit of measure

This function is used to set the unit of measure for temperature (°C or °F).

Proceed as follows to set the required unit:

- briefly press **MODE** (°C) or (°F) will flash on the display (according to the previous setting);
- press button **+** or **–** for setting;
- briefly press button **MODE** to go back to the menu screen or hold the button pressed to go back to the standard screen without storing the settings.

Selecting the language

The messages may be displayed in the following languages: Italian, German, English, Spanish, French, Portuguese.

To set the required language proceed as follows:

- briefly press button **MODE**: the previously set “language” starts flashing on the display;
- press button **+** or **–** for setting;
- briefly press button **MODE** to go back to the menu screen or hold the button pressed to go back to the standard screen without storing the settings.

Adjusting the failure/warning buzzer volume (Buzzer Volume)

This function allows the volume of the buzzer which accompanies the display of failures / warnings to be adjusted (8 levels). To set the desired volume, proceed as follows:

- briefly press button **MODE**: the previously set volume “level” starts flashing on the display;
- press button **+** or **–** to set;
- briefly press button **MODE** to go back to the menu screen or hold the button pressed to go back to the standard screen without storing the settings.

Adjusting the button volume (Button Vol.)

This function is used to set the volume of the roger-beep accompanying the activation of buttons **MODE**, **+ e -** through 8 levels.

To set the desired volume, proceed as follows:

- briefly press button **MODE**: the previously set volume “level” starts flashing on the display;
- press button **+ or -** to set;
- briefly press button **MODE** to go back to the menu screen or hold the button pressed to go back to the standard screen without storing the settings.

S.B.R. buzzer reactivation (Belt Buzzer)

(for versions/markets, where provided)

This function can be only displayed after Lancia Dealership has deactivated the S.B.R. system (see paragraph “S.B.R. system” in section “Safety devices”).

Scheduled Servicing (Service)

This function may be used to display information connected to proper car servicing in terms of kilometres or days.

This information can be consulted as follows:

- briefly press button **MODE**: service in km or mi, according to previous setting, will be displayed (see paragraph “Units”);
- press button **+ or -** to set deadline in days;
- briefly press button **MODE** to go back to the menu screen or hold the button pressed to go back to the standard screen.

NOTE The “Service Schedule” requires the car to be serviced every 20,000 km (or equivalent distance in miles) or once a year. This message will appear automatically with key at **MAR** after 2,000 km (or equivalent distance in miles) or 30 before the deadline and will appear every 200 km (or equivalent distance in miles) or 3 days.

The indications will appear more frequently where there are 200 km left. For 1.3 Multijet versions, refer to the “Service Schedule” in the “Maintenance and care” chapter for replacing the air cleaner, the engine oil and the engine oil filter. The indication will appear in kilometres or miles according to the settings. When the next scheduled service operation is approaching, the message “Service” will appear on the display followed by the number of kilometres or miles left when the key is turned to **MAR**. The “Service Schedule” information is provided with kilometres (km)/miles (mi) or days (dd), according to the deadline which appears first. Go to a Lancia Dealership where the “Scheduled Service” operations will be performed and the message will be reset.

Activating/deactivating the passenger front and side airbag on/off (passenger bag)

(for versions/markets, where provided)

This function shall be used to activate/deactivate the passenger's airbag.

Proceed as follows:

- press **MODE** and after the message (Bag pass Off) (deactivate) or (Bag pass On) (activate) appears by pressing buttons **+** and **-**, press the **MODE** button again;
- the confirmation request message will be displayed;
- press buttons **+** or **-** to select (Yes) (to confirm activation/deactivation) or (No) (to abort);
- briefly press button **MODE**: the display shows a message confirming the selected value. Now, go back to the menu screen or press the button for a prolonged time to go back to the standard screen without storing the settings.

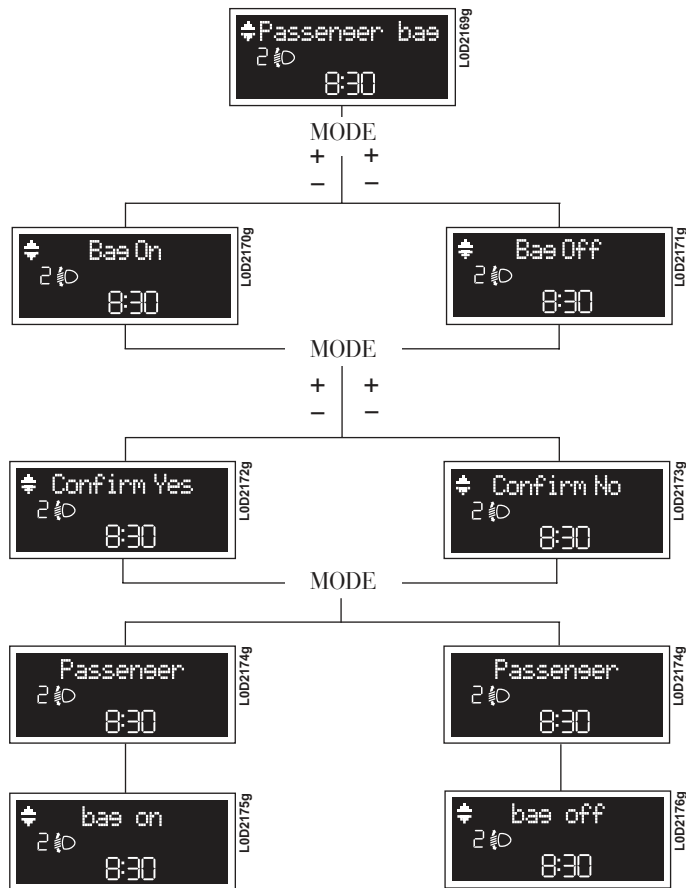

Quitting the menu

This function closes the cycle of settings listed in the menu screen.

Briefly press button **MODE** to go back to the standard screen without storing the settings.

Press button **+** to return to the first menu option (Speed Limit).

TRIP COMPUTER

(for versions/markets, where provided)

General features

The “Trip computer” is used to display information on car operation when the key is turned to **MAR**. This function consists of “General trip” for displaying the complete mission of the car and by “Trip B”, for trips; this function is included in the general trip information (as shown in **fig. 30**).

Both functions can be reset (to start a new trip). The following data can be displayed for “General Trip”:

- Range
- Distance travelled
- Average consumption
- Instant consumption
- Average speed
- Travel time (driving time).

“Trip B” may be used to display the figures relating to:

- Distance travelled B
- Average consumption B
- Average speed B
- Travel time B (driving time).

NOTE “Trip B” functions may be excluded (see “Trip B on”). “Range” and “Instantaneous consumption” cannot be reset.

Values displayed

Range

This indicates the indicative distance which may be travelled with the fuel in the tank assuming that driving conditions do not change. The display will show the reading “----” when the following events take place:

- range lower than 50 km (or 30 miles) or fuel level less than 4 litres in the tank;
- car left parked with engine running for a long time.

Distance travelled

This value shows the distance covered from the start of the new mission.

Average consumption

This indicates the indicative average consumption from the start of the new mission.

Instantaneous fuel consumption

This indicates the fuel consumption. The value is constantly updated. The message “----” will appear on the display if the car is parked with the engine running.

Average speed

This shows the car average speed as a function of the overall time elapsed since the start of the new mission.

Journey time

This value shows the time elapsed since the start of the new mission.

IMPORTANT If information is not available, the message “----” will appear instead of the Trip Computer values. Displaying of the values will be resumed when normal operation is restored without resetting the values displayed before the problem nor starting a new mission.

TRIP button fig. 29

Button **TRIP** located on the top of the right steering column stalk is used (with ignition key at **MAR**) to display and reset the previously described values to start a new mission:

- short push to display the different values
- long push to reset and then start a new mission.

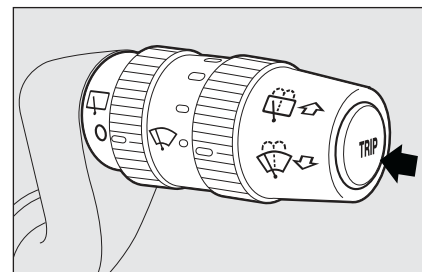

fig. 29

LOD0026m

New mission

The new mission begins after:

- “manual” resetting by the user, by pressing the relevant button;
- “automatic” resetting, when the “Trip distance” reaches 9999.9 km or when the “Travel time” reaches 99.59 (99 hours and 59 minutes);
- after disconnecting/reconnecting the battery.

IMPORTANT “General Trip” resets will reset “Trip B” at the same time, while resetting “Trip B” will only reset the values of the trip B function.

Start trip procedure

With ignition key on **MAR**, press and hold button **TRIP** pressed for over 2 seconds to reset.

Quitting TRIP

The **TRIP** function shuts down automatically after displaying all the data. Alternatively, hold **MODE** pressed for longer than two seconds.

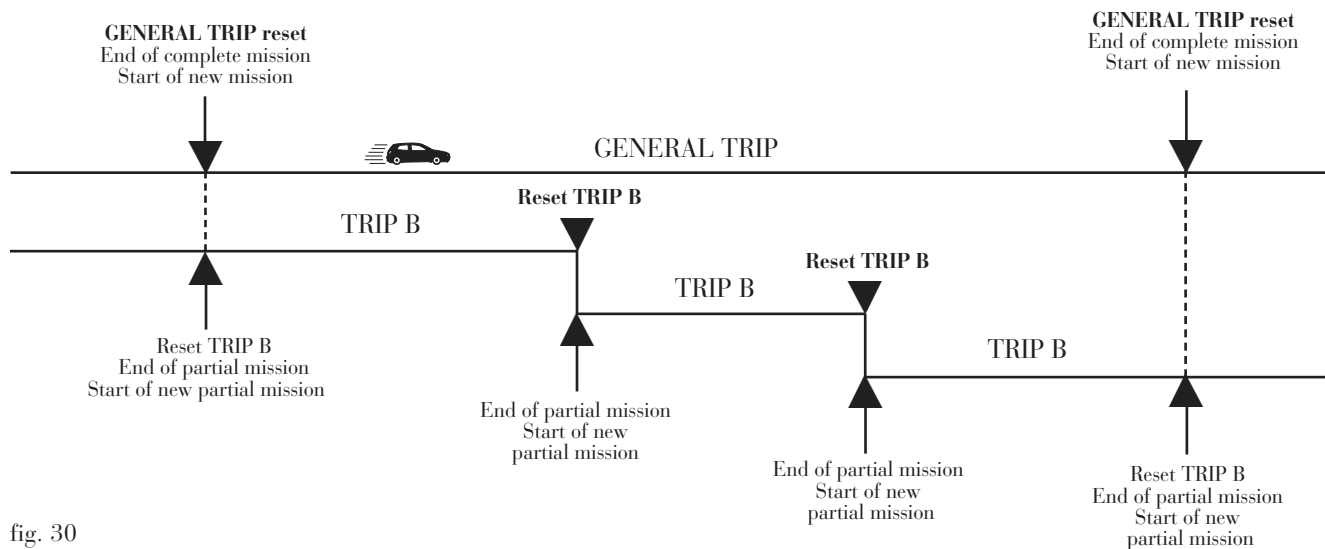

fig. 30

ADJUSTING THE SEATS

FRONT SEATS

Fore/aft adjustment

Lift lever **A**-**fig. 31** and push the seat forwards and backwards to reach the required position: your arms should rest on the steering wheel rim while you are driving.

Check that the seat is locked well on the guides by trying to push it forwards and backwards.

Adjusting the height (driver's seat)

(for versions/markets, where provided)

Move lever **B**-**fig. 31** upwards or downwards to achieve the required height.

IMPORTANT Sit in the driver's seat with the car not moving to adjust.

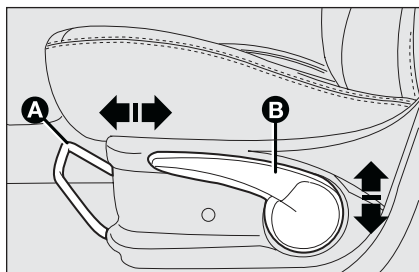

fig. 31

L0D0041m

Adjusting backrest inclination

Operate the lever **D**-**fig. 32** in the direction of the arrow, take the backrest to the required position and then release it.

Lumbar adjustment

(for versions/markets, where provided)

To adjust the support between back and backrest, turn knob **C**-**fig. 32** clockwise to increase the lumbar support or anticlockwise to decrease it.

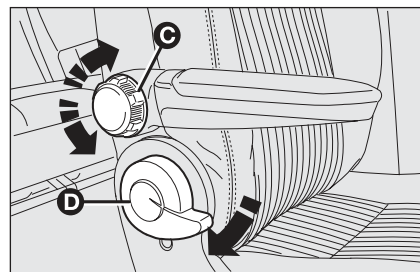

fig. 32

L0D0042m



WARNING

Make sure that the seats are correctly secured after making the adjustments.

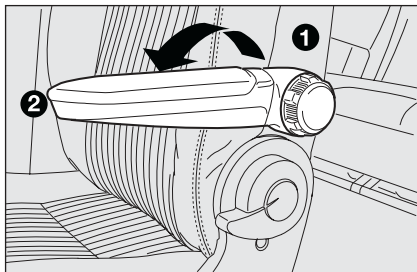

fig. 33

L0D0043m

Armrest adjustment fig. 33

(for versions/markets, where provided)

To use the armrest, move it from position **1** to position **2**.

Arranging the passenger seat in table position

Move the armrest (for versions/markets, where provided) to vertical position.

From the driver's seat or from the rear seats, operate the lever **A**-fig. 34 in the direction of the arrow, fold the backrest **fig. 35** onto the cushion and then release it. In this position, the backrest may be used as a table.

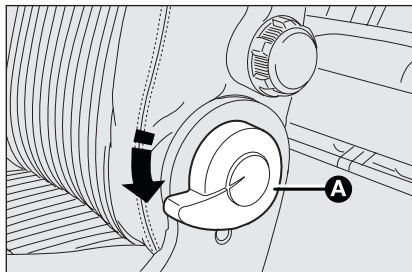

fig. 34

L0D0044m

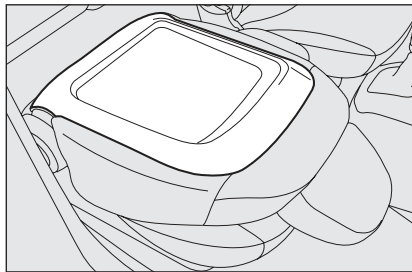

fig. 35

L0D0045m

Arranging the driver's seat in table position

To arrange the driver's seat in table position, remove the head restraint (see "Extracting the head restraint" in the "Head restraint" chapter) and proceed as shown above.

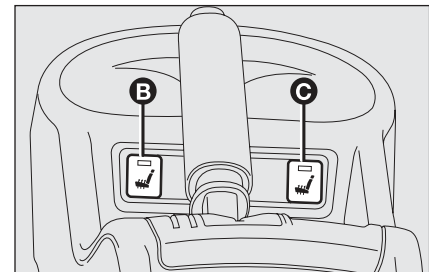

fig. 36

L0D0046m

Heated seats

(for versions/markets, where provided)

Press buttons **B**-fig. 36 to heat the driver's seat **C**-fig. 36 and to heat the passenger's seat.

The LED in the button will light up when heating is on.

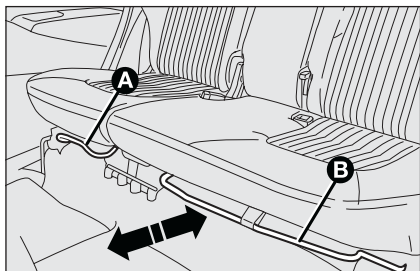

fig. 37

LOD0047m

SLIDING REAR SEATS

Adjusting from inside the passenger compartment

Fore/aft adjustment

Respectively lift the lever **A**-fig. 37 or the lever **B** to adjust the required seat portion, then push the seat back or forwards.

Adjusting backrest inclination

Push the lever **C**-fig. 38, move the backrest to position and then release it.

To prevent irregular operation: press the lever **C** as far as it will go.

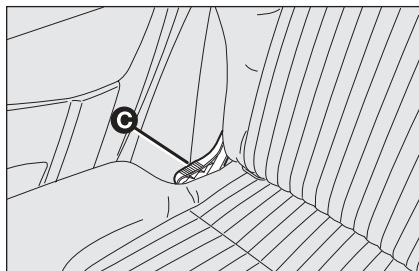

fig. 38

LOD0252m

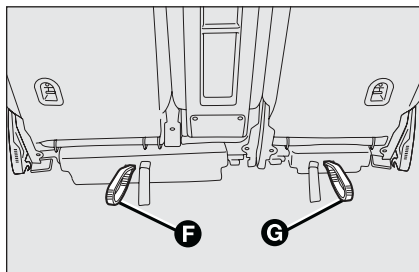

fig. 39

LOD0253m

Adjusting from inside the boot

Fore/aft adjustment

Operate on handles **F** and **G**-fig. 39 to adjust the required seat portion by pushing the seat forwards or backwards.

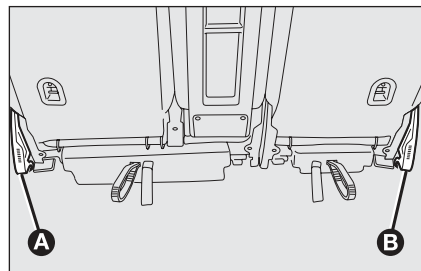

fig. 40

LOD0049m

Adjusting backrest inclination

Operate lever **A** or lever **B**-fig. 40 to adjust the required backrest portion, take the backrest to position and then release.



WARNING

Make sure that the seats are correctly secured after making the adjustments.

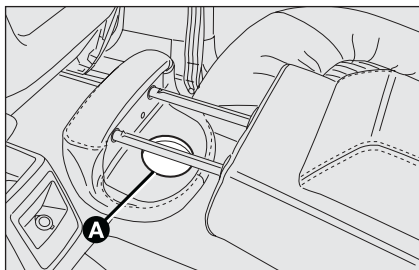

fig. 41

L0D0051m

Adjusting the central unit from the inside

To move the central unit to the horizontal position:

- operate the lever **D**-fig. 42 (one per side)
- fully lower the central unit
- release the lever.

The cup holder **A**-fig. 41 (for versions/markets, where provided) can be used when the central unit is all down and the head restraint is removed.

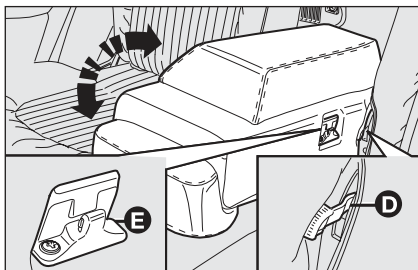

fig. 42

L0D0050m

To arrange the central unit back in vertical position, operate lever **D**-fig. 42 again (one on each side) and realign the unit with the side backrests and make the safety clip **E**click.

Using the compartment inside the central unit

The central unit is provided with a compartment **B**-fig. 43.

To use the compartment **B** press button **C** and lift up the cushion.

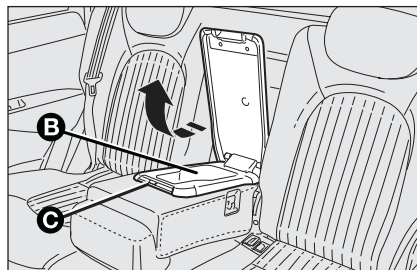

fig. 43

L0D0358m



WARNING

After releasing the lever, always check that the seat is locked on the guides by trying to move it backwards and forth. If it is not locked, the seat may move unexpectedly and make you loose control of the car.



WARNING

For maximum safety, keep the back of your seat upright, lean back into it and make sure the seat belt fits closely across your chest and hips.

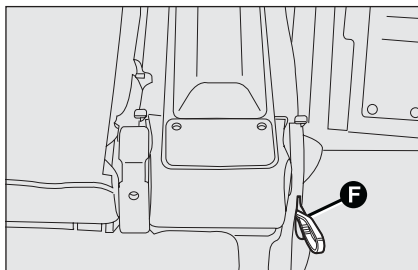

fig. 44

L0D0255m

Adjusting the central unit from the boot

Pull the ribbon **F**-**fig. 44** and push forward the upper part of the backrest until the retainer clicks. Accompany the backrest to the horizontal position and release the ribbon **F**. Reverse the operation to reposition the backrest in vertical position and make sure that the retainer clicks.

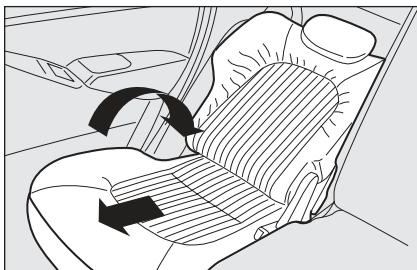

fig. 45

L0D0242m

Relax position (passenger side) fig. 45

To arrange the seat in relax position, with the door open:

- arrange the passenger's seat in table position (see "Arranging the seat in table position" paragraph in this chapter);
- push the rear seat forward as far as it will go **fig. 46**;
- push the passenger's seat (in table position) as far back as it will go;
- remove the rear window shelf (see the "Removing the rear window shelf" paragraph in this chapter);
- recline the rear seat backrest to the required position.

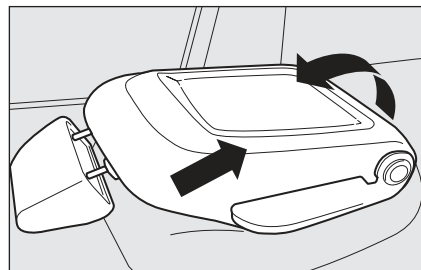

fig. 46

L0D0243m

Relax position (driver's side)

Proceed in the same way, this time removing the head restraint from the driver's seat (see the "Head restraint" paragraph in this chapter).

IMPORTANT Refer to the "Expanding the boot" chapter for moving the seats to expand the boot.

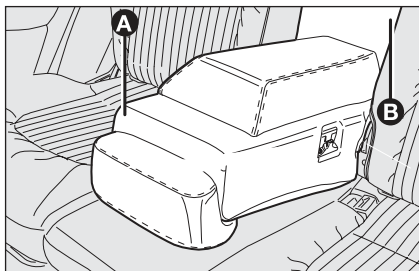

fig. 47

L0D0249m

Adjusting the central unit and using the ski compartment

The central unit may be lowered and used as rear armrest. Access to the ski compartment **B**-fig. 47 can be obtained in this manner.

The compartment **B** may be used for transporting long items (e.g. skis). Insert the item from the boot.

It is advisable to remove the cushion **C** to prevent damage.

IMPORTANT Avoid putting the cushion **C** in the boot in contact with heavy loads to prevent damage.

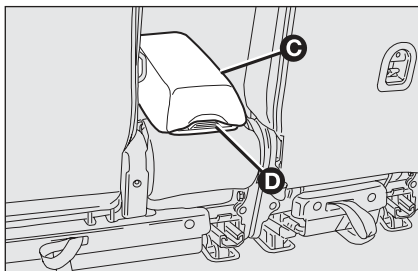

fig. 48

L0D0344m

Removing the cushion

The cushion **C**-fig. 48 can be removed.

To remove the cushion: operate the button **D** and extract it from the central unit.

To refasten: press the button **D** to release it from the retainer on the seatback and make sure that it fastened well.



WARNING

Secure heavy loads in the ski compartment to prevent them from being hurled forward in case of crashes or sudden braking.



WARNING

All adjustments must be made with the car stationary:

Fixed rear seats

(for versions/markets, where provided)

See the “Expanding the boot” paragraph for how to fold the seat.

HEAD RESTRAINTS

FRONT

The head restraints can be adjusted in height.

To adjust the height: pull the head restraint upwards or press button **A**-fig. 49 and push it downwards. Make sure that it clicks at the end of the operation.

Extracting the head restraint

Press button **B**-fig. 50 to extract the head restraint.

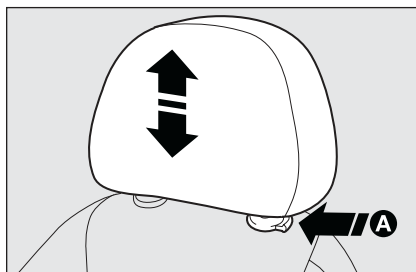

fig. 49

LOD0052m

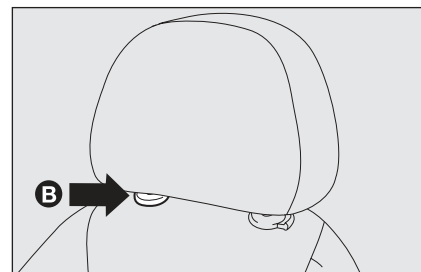

fig. 50

LOD0237m

REAR SIDE AND CENTRAL

(for versions/markets, where provided)

The head restraints can be adjusted in height.

To raise them, simply move the head restraints up until you hear the click.

To lower them, press button **C**-fig. 51.

To extract them (not needed for normal configurations) press button **D**-fig. 51.

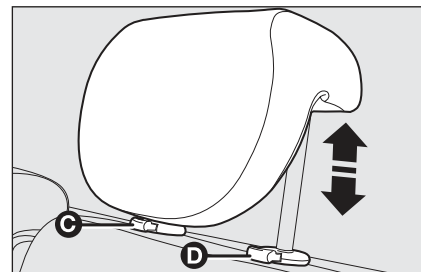

fig. 51

LOD0053m



WARNING

Travelling without head restraints is dangerous.



WARNING

If side bags are fitted, using seat covers other than those from Lineaccessori Lancia is dangerous.



WARNING

The head restraints must be adjusted so that they support your neck and not your head. Only in this way may they perform their protective action.



WARNING

To optimise head restraint protective action, adjust the seat back upright and keep your head as close as possible to the head restraint.



WARNING

To refit the head restraint, arrange it the right way and then proceed as for checking that it is locked.



WARNING

Saddle-shaped rear head restraints optimise visibility and must always be raised it when an occupant is present.

ADJUSTING THE STEERING WHEEL

The steering wheel can be adjusted in height **A**-fig. 52 and in depth **B**.

To carry out the adjustment, proceed as follows:

- release the lever by pulling it towards the steering wheel (position 2);
- adjust the steering wheel as required;
- release the lever by pushing it forwards (position 1);

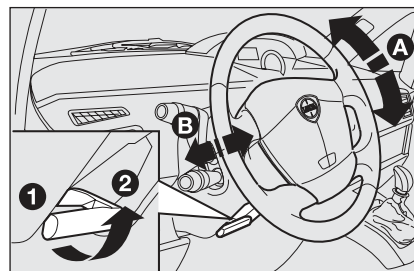

fig. 52

LOD0382m



WARNING

Any adjustment of the steering wheel position must be carried out only with the car stationary and the engine turned off.



WARNING

It is absolutely forbidden to carry out whatever after-market operation involving steering system or steering column modifications (e.g.: installation of anti-theft device) that could badly affect performance and safety; cause the lapse of warranty and also result in non-compliance of the car with homologation requirements.

REARVIEW MIRRORS

INTERNAL MIRROR

The mirror is fitted with a safety device that causes its release in the event of a violent impact with the passenger.

It can be moved using the lever **A**-**fig. 53** to two different positions: normal or antiglare.

DOOR MIRRORS

The mirrors can only be adjusted/folded with the ignition in the **MAR** position.

To carry out the adjustment, proceed as follows:

- use switch **B**-**fig. 54** to select the mirror required (left or right);
- to adjust the mirror move the switch **C** in the four directions.

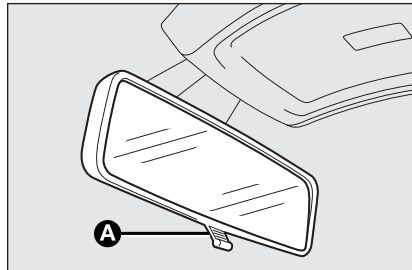

fig. 53

L0D0056m

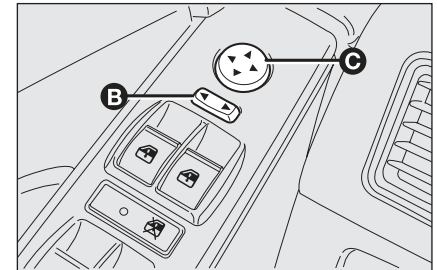

fig. 54

L0D0058m

Adjust with the vehicle stationary and the handbrake applied.

The mirror demister will be turned on automatically by the rear window heater.

Folding

When required (for example when the mirror causes difficulty in narrow spaces) it is possible to fold the mirror moving it from position **1** to position **2**-**fig. 55**.

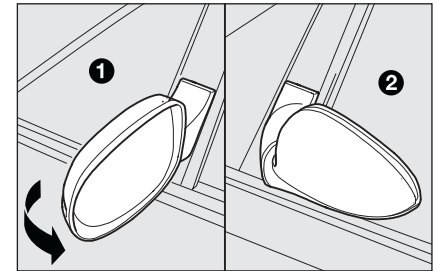

fig. 55

L0D00499m



When driving the mirrors shall always be in position 1-fig. 55.

As the driver's door mirror is curved, it may slightly alter the perception of distance.

HEATING/CLIMATE CONTROL SYSTEM

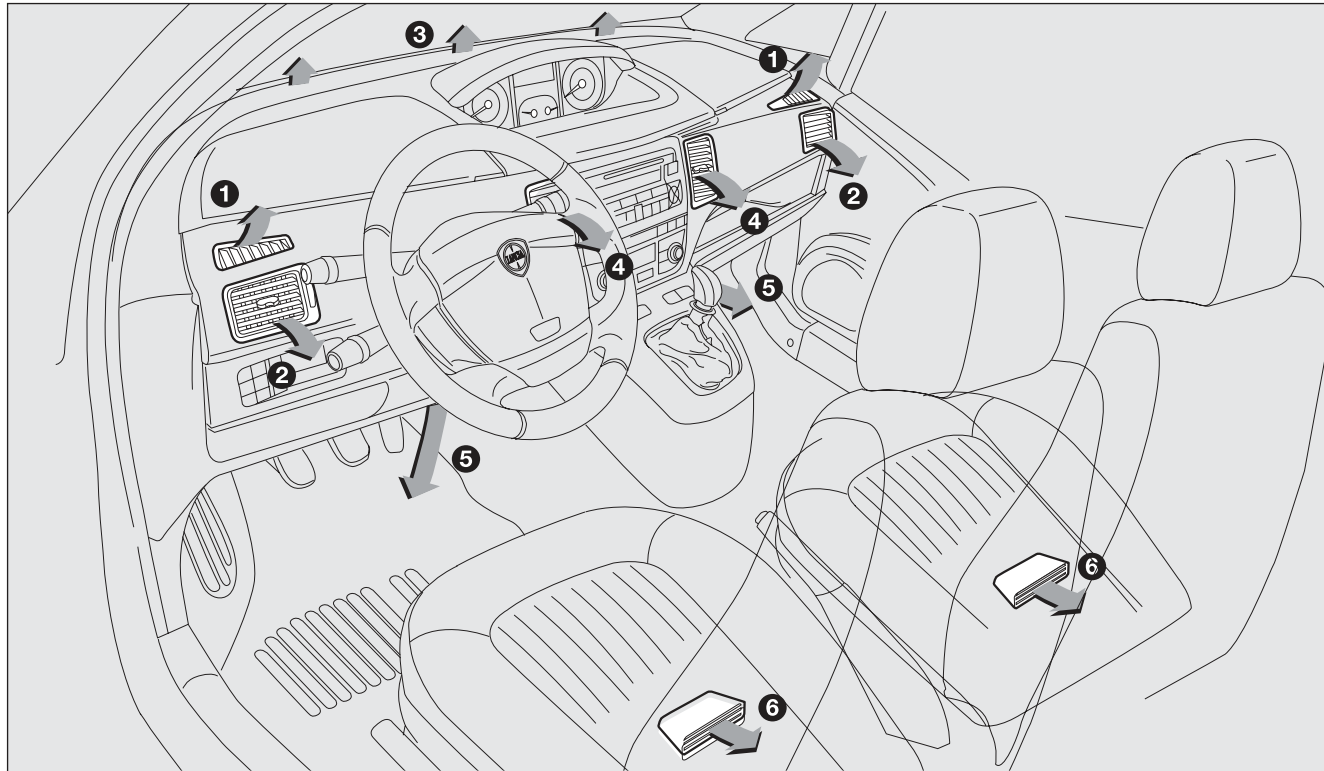

fig. 56

L0D0383m

1. Fixed vents for defrosting/demisting the side windows - 2. Adjustable side air vents - 3. Fixed windscreen defroster/demister vents - 4. Adjustable central vents - 5. Lower vents - 6. Rear passenger lower vents.

DASHBOARD
AND
CONTROLS

SAFETY

STARTING
AND DRIVING

WARNING
LIGHTS AND
MESSAGES

IN AN
EMERGENCY

MAINTENANCE
AND CARE

TECHNICAL
SPECIFICA-
TIONS

INDEX

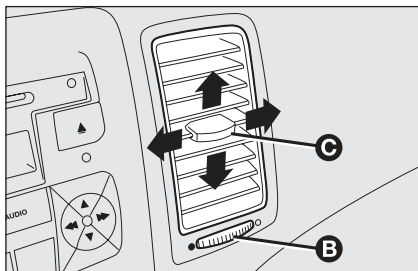

fig. 57

L0D0061m

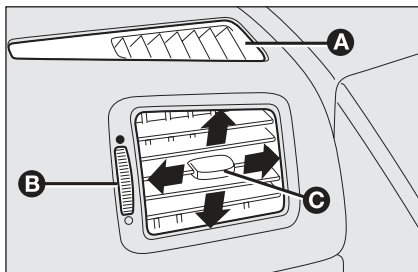

fig. 58

L0D0062m

CENTRAL AND SIDE VENTS

fig. 57-58

- A** Fixed vents for defrosting/demisting side windows.
- B** Vent open/closed control
- C** Vent direction and air flow control

MANUAL CLIMATE CONTROL SYSTEM

(for versions/markets, where provided)

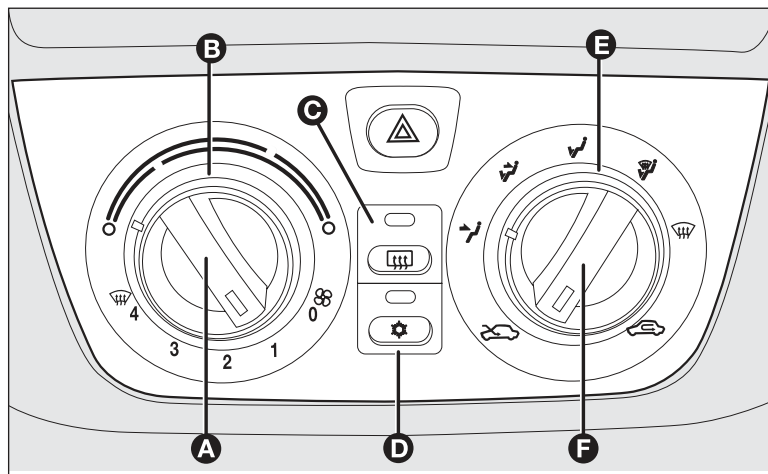

fig. 59





L0D0064m

CONTROLS

- A** fan and fan speed knob
- B** air temperature knob (for mixing warm/cool air)
- C** heated rear window on/off button
- D** climate control compressor on/off button;
- E** air distribution selection ring
- F** air recirculation knob.

AIR DISTRIBUTION

The ring **E** is used to make fresh air reach the entire passenger compartment. There are five selections:

-  air from central vents and side vents 2 and 4;
-  air from central side vents 2 and 4 and downward vents 5 and 6 (bi-level function);
-  air downwards 5 and 6;
-  air downwards 5 and 6 and to the windscreen 3;
-  for demisting and defrosting the windscreen 3 and the front side windows 1.



SETTING THE TEMPERATURE

Proceed as follows:

Turn the ring **B-fig. 59** (indicator pointing to the red sector) rightwards to turn the temperature up or leftwards to turn it down;

ADJUSTING THE FAN SPEED

To ventilate the passenger compartment properly proceed as follows:

- fully open the central 4 and side 2 air vents;
- turn the ring **B-fig. 59** to the blue sector;
- turn knob **A** to the required speed;
- turn the ring **E** to .
- stop internal air recirculation by turning knob **F** to .

ACTIVATING THE INTERNAL AIR RECIRCULATION



Position the knob **F-fig. 59** to .

It is advisable to switch internal air recirculation on while standing in queues or in tunnels to prevent the introduction of polluted air. Do not use the function for a long time, particularly if there are many occupants on board, to prevent the windows from misting up.

IMPORTANT The air recirculation system makes it possible to reach the required heating or cooling conditions faster. Do not use the air recirculation function on rainy/cold days as it would considerably increase the possibility of the windows misting inside.



QUICK HEATING

Proceed as follows:

- close all the vents on the dashboard;
- turn the ring **B**-fig. 59 to the red sector;
- turn knob **A** to 4 ;
- turn ring **E** to .

FRONT WINDOW FAST DEMISTING/ DEFROSTING (WINDSCREEN AND SIDE WINDOWS)



Proceed as follows:

- turn knob **B** to the red section;
- turn knob **A** to 4 .
- turn ring **E** to .
- stop air recirculation by turning knob **F** to .

After demisting/defrosting, operate the controls normally used to restore the required comfort.

Window demisting

In the event of considerable outside moisture and/or rain and/or considerable differences in temperature inside and outside the passenger compartment, perform the following preventive demisting procedure:

- stop internal air recirculation by turning knob **F**-fig. 59 to .
- turn knob **B** to the red section;
- turn knob **A** to 2;
- turn ring **E** to  or to position  if the windows are not demisted.

IMPORTANT The climate control system is very useful for demisting the windows: simply press **D** to operate the system and demist the windows.

HEATED REAR WINDOW AND DOOR MIRROR DEMISTING/DEFROSTING

(for versions/markets, where provided)



Press button **C-fig. 59** to activate the function. The LED in the button will light up when the function is on.

The function is timed and automatically deactivated by the system after a given time. Press **C** again to switch it off before.

IMPORTANT Do not apply stickers on the inside of the rear window over the heating filaments to avoid damage that might cause it to stop working properly.

AIR CONDITIONING (cooling and dehumidifying)

Proceed as follows:

- turn the ring **B-fig. 59** to the blue sector to select the temperature;
- turn knob **A** to the required speed;
- turn the ring **E** to ;
- turn the knob **F** to .
- press button **D**  (the LED on the button will light up).

Cooling

Proceed as follows:

- stop internal air recirculation by turning knob **F-fig. 59** to .
- turn ring **B** clockwise to increase the temperature;
- turn knob **A** anticlockwise to reduce the fan speed.

LOOKING AFTER THE SYSTEM

Run the climate control system for at least 10 minutes every month during the winter. Have the system inspected at a Lancia Dealership before the summer.

AUTOMATIC TWO- ZONE CLIMATE CONTROL SYSTEM

(for versions/markets, where provided)

GENERAL INFORMATION

The two-zone automatic climate control system distributes air in the passenger compartment in two zones: driver's and passenger's side. Temperature is controlled on the basis of an "equivalent temperature" principle; in other words, the system continuously works to keep the comfort level inside the car constant and to compensate for possible variations of external conditions, including sun radiation detected by a specific sensor.

The automatically controlled parameters and functions are:

- air temperature at the vents on driver/front passenger side;
- air at vents on driver/front passenger side;
- fan speed (continuous air flow variation);

- compressor activation (to cool/dehumidify air);
- air recirculation.

All functions may be manually changed. In order words, you may select one or more functions and change the parameters as required. Automatic control of the manually changed functions will be suspended: the system will change override your settings only for safety related reasons (e.g. risk of misting up).

Manual selections will always have higher priority over automatic settings and will be stored until the user switches the system back to automatic mode, except for the cases in which the system will intervene for particular, safety-related reasons.

You can adjust one function automatically and have the automatic system control all the others.

The amount of air introduced into the passenger compartment is independent from speed of the car because the fan is controlled by the electronic system.

The temperature of the air taken in is always controlled automatically depending on the temperature set on the display (except when the system is turned off or under certain conditions when the compressor is off. The following parameters and functions can be manually set:

- air temperature on driver/front passenger side;
- fan speed (continuous variation);
- air distribution to five positions (driver/front passenger side);
- compressor on;
- one-zone/two-zone distribution priority;
- fast demist/defrost function;
- air recirculation;
- heated rear window;
- system off.

CONTROLS

- A:** **MONO** function button (set temperature alignment)
- B:** climate control compressor on/off button;
- C:** air recirculation on/of button
- D:** climate control system information display

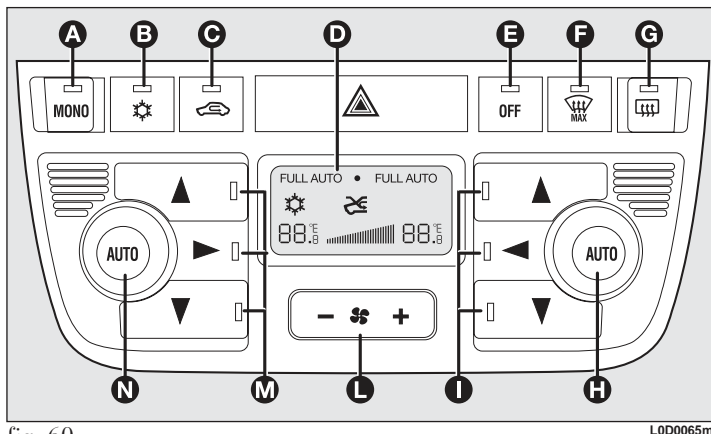

fig. 60

L0D0065m

- E:** climate control system off button
- F:** **MAX-DEF** button (windscreen quick defrosting/demisting)
- C:** heated rear window on/off button
- H:** **AUTO** button (automatic operation) and passenger side temperature knob
- I:** passenger side air distribution buttons
- L:** fan speed up/down
- M:** driver side air distribution buttons
- N:** **AUTO** function button (automatic operation) and temperature setting knob driver side



USING THE CLIMATE CONTROL SYSTEM

The system can be started in different ways, but it is advisable to press one of the **AUTO** buttons and then to turn the knobs to set the temperatures required on the display.

The system manages two passenger compartment zones: the driver and passenger can therefore select different temperatures. The maximum difference between the two zones is 7°C.

The system will start running automatically in this way and the set comfortable temperature will be reached as quickly as possible. The system adjusts the temperature, amount and distribution of air delivered to the passenger compartment. In addition, it manages the recirculation function to engage the climate control system compressor.

During fully automatic operation, the only functions that are enabled manually are:

- MONO** to uniform the temperature and the air distribution on front passenger or rear passenger zones to the driver's zone;
-  air recirculation, to keep it always on or off;
-  to speed up demisting/defrosting of windscreen, side windows, rear window and door mirrors;
-  to demist/defrost the heated rear window and the external rearview mirrors.

During completely automatic system operation, you can vary the set temperature, the air distribution and the fan speed using the corresponding buttons or knobs at any time: the system will automatically change settings to adapt to the new request.

During fully automatic operation (**FULL AUTO**), the word **FULL** will disappear if the air distribution, air speed, compressor and/or recirculation settings are changed. In this way, the functions will switch from automatic to manual control until **AUTO** is pressed again. The fan speed is the same in all the zones of the passenger compartment.

With on or more manually set functions, the introduced air temperature is still managed automatically by the system, except for when the compressor is off: in the case, the air introduced into the passenger compartment cannot be cooler than the outside air.

CONTROLS

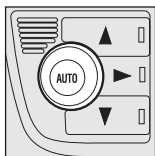

H-N air temperature setting knobs

Turn the knobs clockwise or anticlockwise to turn the temperature up or down in the front left zone (knob **N**) and the right zone (knob **H**) of the passenger compartment respectively.



The system manages two passenger compartment zones: the driver and passenger can therefore select different temperatures. The maximum difference between the two zones is 7°C.

The set temperature is shown on the display near the knobs.

Press **A (MONO)** to automatically align the temperature in the front passenger zone to the driver's side temperature. The same temperature can be set in both zones by turning knob **N** on driver's side.

This function is used to adjust the temperature in the passenger compartment when the driver only is in the car.

To go back to separate air and temperature distribution in the two zones of the passenger compartment, simply turn the knobs **H** or press **(A-MONO)** when the LED on the button is on.

Turn the knobs either all to the right or all to the left to the extreme **HI** or **LO** positions to use the maximum heating or maximum cooling functions:

HI function (maximum heating):

select by turning the temperature knob clockwise over the maximum value (32 °C). It can be operated from either by the driver or by the front passenger (by selecting the **MONO** function).

This function may be used to heat up the passenger compartment as fast as possible and exploit the system potential to the maximum. The function uses the maximum coolant temperature while air and fan speed distribution are managed by the system according to conditions.

Specifically, if the heating fluid is not warm enough, the fan will not start up at the maximum speed immediately to limit introducing excessively cool air into the passenger compartment.

All manual settings will be allowed when this function is on.

To switch the function off, simply turn the temperature knob anticlockwise and set the required temperature.

LO function (maximum cooling):

select by turning the temperature knob anticlockwise under the minimum value (16 °C). It can be operated from either by the driver or by the front passenger (by selecting the **MONO** function).

This function may be used to cool down the passenger compartment as fast as possible and exploit the system potential to the maximum. The function activates air recirculation and the climate control compressor, air distribution and fan speed are managed by the system according to environmental conditions. All manual settings will be allowed when this function is on.

To switch the function off, simply turn the temperature knob anticlockwise and set the required temperature.

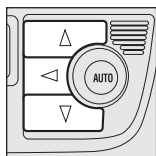
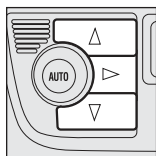

I-M air distribution buttons

Press these buttons to manually set one of the five possible air distribution patterns on the left and on the right side of the passenger compartment:

- ▲ Air flow to the windscreen and front side window vents to demist or defrost them.
- ▶ Air flow at central and side dashboard vents to ventilate the chest and the face during the hot season.
- ▼ Air flow to the front and rear foot well vents. Thanks to the natural tendency of hot air to spread upwards, this distribution pattern allows to warm the passenger compartment up as quickly as possible, providing an immediate feeling of warmth.

▶ Air flow between foot well vents (hotter air) and central and side dashboard vents (cooler air). This distribution is particularly useful in spring and autumn on a sunny day.

◆ Air flow distributed between foot well vents and windscreen and front side window defrosting/demisting vents. This allows an adequate warming of the passenger compartment and prevents the windows from misting up.

The set distribution is shown by the corresponding LEDs on the selected buttons. When the combined function is on, press a button to activate the corresponding functions along with the settings. If the button corresponding to a previously active button is pressed, the function is turned off and the corresponding LED will go out.

To restore automatic air distribution control after a manual adjustment, press button **AUTO**.

Air distribution is automatically aligned on driver and passenger side when the driver selects air distribution towards the windscreen. The passenger can select a different distribution by pressing the corresponding buttons afterwards.

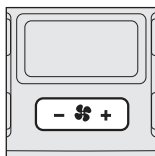

Fan speed adjustment buttons L

Press button  to increase or to decrease the fan speed and therefore the amount of air admitted into the passenger compartment, although keeping the required temperature set.

The fan speed is shown by the lit bars on the display:

- Maximum fan speed = all bars lit
- Minimum fan speed = one bar lit.

The fan can be cut off only if the climate control compressor has been switched off pressing button **B**.

IMPORTANT To restore automatic fan speed control after a manual adjustment, press button **AUTO**.

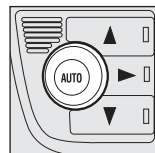
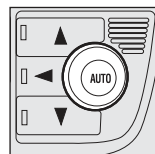

AUTO H-N buttons (automatic operation)

Press **AUTO** driver's side and/or passenger's side to automatically adjust the air speed and air distribution in the corresponding zones cancelling all previous manual settings.

The message **FULL AUTO** will appear on the front display in this condition.

By manually intervening on at least of the functions automatically managed by the system (air recirculation, fan speed or compressor on/off), the word **FULL** will disappear from the display indicating that the system is no longer automatically controlling all the functions (the temperature will still be controlled automatically by the system).

IMPORTANT Should the system (after manual settings) be no longer able to guarantee the required temperature set in the passenger compartment, the set temperature value will start flashing to indicate this condition, after one minute the **AUTO** message will go out.

To restore system automatic control at any time, after one or more manual adjustments, press button **AUTO**.

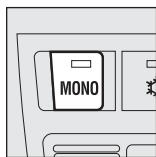



MONO A button (for aligning temperature and air distribution settings)

Press **MONO** to automatically align air temperature and distribution settings in the front passenger area to those of in the driver's area and to therefore set both zones by turning the knob on driver's side only. This function is used to adjust the temperature in the entire passenger compartment in presence of the driver only. To go back to separate air and temperature distribution in the two zones of the passenger compartment, simply turn the knobs **H** or press **A-MONO** when the LED on the button is on.



Air recirculation on/off button C

Air recirculation works according to the following operating logics:

- forced switching on (inside air recirculation always on), indicated by the turning off of the button led **C** and symbol  on the display;
- function off (air recirculation always off and introduction of external air), indicated by the fact that the LED on the button will go off and symbol  will appear on the display.

These operating conditions are obtained by pressing **C** in sequence.

For safety reasons, the system will automatically turn the recycle function off to allow the introduction of fresh air after a certain time.

IMPORTANT The air recirculation function makes it possible to reach the required heating or cooling conditions faster. It is however inadvisable to use it on rainy/cold days as it would considerably increase the possibility of the windows misting inside, especially if the climate control compressor is off.

Recirculation is forced off (i.e. air is introduced from the outside) when the the outside temperature is colder than 5-7°C to prevent misting up.



WARNING

It is advisable not to use the air recirculation function when the outside temperature is low to prevent the windows from rapidly misting up.

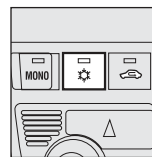

Climate control compressor on/off button B

Press button  when the LED on the button is on, to turn the climate control compressor off. The LED will go out. Press the button when the LED is off to restore automatically system control and use of the compressor. The LED will light up on the button in this case.

The system will switch recirculation off when the compressor is switched off to prevent misting up. Although the system is capable of maintaining the required temperature, the word **FULL** will disappear from the display. If on the other hand the system cannot maintain the required temperature, the digits will blink and the word **AUTO** will disappear.

IMPORTANT With the compressor off, it is not possible to introduced air cooler than ambient temperature into the passenger compartment. Furthermore, in certain conditions, the windows could mist up rapidly because the air is not dehumidified.

The switching off of the climate control compressor remains in storage even when the engine has been stopped.

To restore automatic compressor control, press  again (in this case, the system will only work as a heater) or press **AUTO**.

When the compressor is off, if the external temperature is hotter than the set temperature and the system cannot satisfy the request, the digits of the set temperature will blink for a few seconds and the message **AUTO** will go out.

With climate control compressor off, the fan speed can be set to zero manually (no bar shown).

With the compressor on and the engine started, the fan speed may be reduced to the minimum setting (only one bar shown).

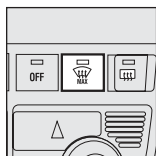

Fast window demisting/defrosting button F

Press this button: the climate control system will automatically switch on all the functions required for fast windscreen and front side window demisting/defrosting, that is:

- climate control compressor on when weather conditions are suitable;
- air recycle off;
- maximum air temperature **HI** on both areas;
- proper fan speed according to engine coolant temperature to limit the flow of not sufficiently warm air to demist the windows into the passenger compartment;
- air flow to the windscreen and front side windows vents;
- the heated rear window on

IMPORTANT The fast demist/defrost function will remain on for approximately 3 minutes, from when the engine coolant reaches a temperature of 50°C (petrol versions) or 35°C (Multijet versions).

When this function is on, the LED of the corresponding button switches on and that of the rear window demister. The message **FULL AUTO** goes off on the display.

You can only adjust the fan speed and switch the rear window demister off manually when this function is active.

To restore running operations before this function was activated, press either button **F**, air recirculation button **C**, compressor button **B** or button **AUTO N** or **H**.



Rear window heater and external rearview mirror heater on/off button G

Press this button to turn the rear window demister/defroster on. The LED in the button will light up when the function is on.

The heater will go out automatically after a certain time or by pressing the button again. It will also go out when the engine is stopped until it is started again.

IMPORTANT Do not apply stickers over the electric filaments on the inside of the rear window to prevent damage and ensure perfect operation.

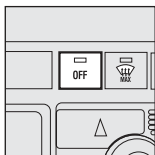

Switching the system off E

Press **E** to switch the climate control system off. The display will go out as a conse-

quence.

The following climate control conditions will be established when the system is off:

- LEDs off;
- set temperature not shown;
- air recirculation on, passenger compartment isolated from the outside;
- air conditioner compressor off;
- fan off.

The rear window heater can be turned on and off manually by pressing **G** when the system is off.

IMPORTANT The climate control system control unit stores the settings before the system is turned off and represents the same settings when it turned back on by pressing any button (except for the heated rear window). If the function corresponding to the pressed button was off, it will be turned on; if it was on, it will be kept on.

Press **AUTO** to turn the climate control system in fully automatic mode.

EXTERNAL LIGHTS

The left-hand lever includes the controls for the external lights.

The external lights can only be switched on when the ignition key is at **MAR**.

LIGHTS OFF Fig. 61

Turn the ring to position **O**.

SIDE/TAIL LIGHTS Fig. 62

Turn the ring to **☼**.

The warning light **☼** on the instrument cluster will come on at the same time.

DIPPED BEAM HEADLIGHTS fig. 63

Turn the ring to **☾**.

The warning light **☾** on the instrument cluster will come on at the same time.

BEAM HEADLIGHTS Fig. 64

With the ring at **☾**, pull the lever towards the steering wheel (permanent position).

The warning light **☾** on the instrument cluster will come on at the same time.

To turn the beam headlights off, pull again the lever towards the steering wheel (dipped beams will turn on again).

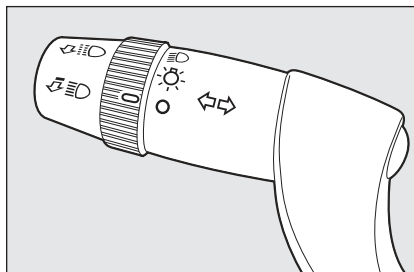

fig. 61

LOD0066m

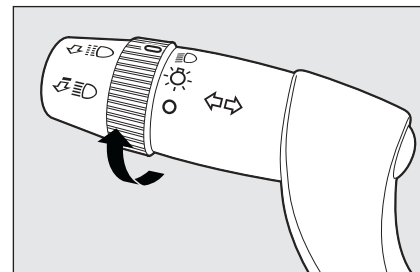

fig. 63

LOD0068m

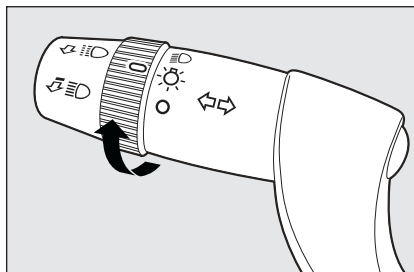

fig. 62

LOD0067m

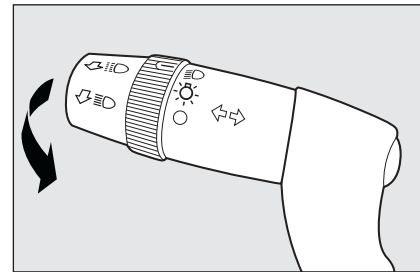

fig. 64

LOD0069m

FLASHING THE HEADLIGHTS

Pull the stalk towards the steering wheel (unstable position) regardless of the position of the ring. The warning light **☾** on the instrument cluster will come on at the same time.

PARKING LIGHTS fig. 65

With the key at **STOP** or extracted, turn the ring to position **☼**. Warning light **☼** on the instrument panel will go on with the side/taillights and the number plate lights. Move the stalk upwards **1** to turn on the right side lights only; move it downwards **2** to turn on the left side lights only. In either case, warning light **☼** will not light up on the instrument cluster.

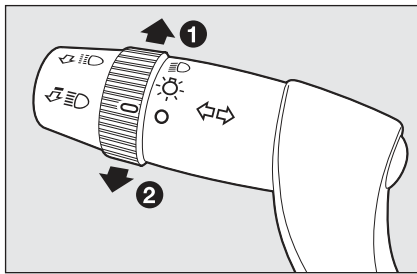

fig. 65

L0D0071m

DIRECTION INDICATORS

Fig. 65

Push the stalk to (stable) position:

- upwards (position 1): right-hand indicator;
- downwards (position 2): left-hand indicator;

Warning light \leftarrow or \rightarrow comes on intermittently on the instrument panel.

Indicators are switched off automatically when the steering wheel is straightened.

If you want the indicator to flash briefly to show that you are about to change lane, move the stalk up or down without clicking into position (unstable position). When released the stalk will return to its home position.

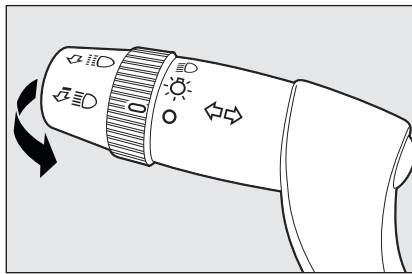

fig. 66

L0D0070m

“FOLLOW ME HOME”

DEVICE fig. 66

This function allows the illumination of the space in front of the car for a preset period of time.

Activation

With the ignition key on **STOP** or removed, pull the stalk towards the steering wheel within 2 minutes from when the engine is turned off.

At each single movement of the stalk, the lights will remain on for an extra 30 seconds up to a maximum of 210 seconds; then the lights are switched off automatically.

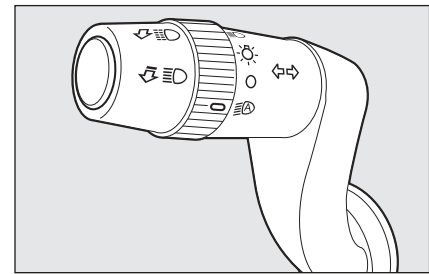

fig. 67

L0D0072m

AUTOMATIC LIGHT SENSORS

(dusk sensor)

(for versions/markets, where provided)

This sensor detects changes of external lights according to the sensitivity of the setting: the higher the sensitivity, the lower the amount of external light needed to switch the lights on. The sensitivity of the dusk sensor is adjusted by means of the “Setup menu” on the “Multifunctional display”.

Activation

Turn the ring to ☀ fig. 67 to light up the side/tail lights and dipped beam headlights according to the external brightness.

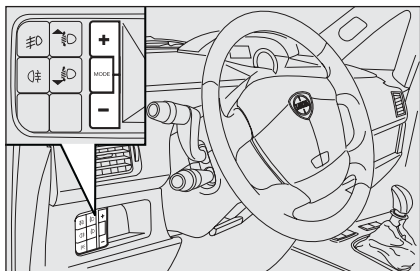

fig. 68

L0D0384m

The set sensitivity level of the sensor will appear on the multifunction display when the automatic headlight sensor is on. Adjust sensitivity by pressing **+** and **-** (see **fig. 68**) while the setting appears on the display.

Deactivation

When the command to switch off is given by the sensor, the dipped headlamps are deactivated and then the side lights about 10 seconds later.

If the main beam heads are turned on (manually by the driver) while the automatic headlight function is on, the main beam headlights will be turned off when the lights are automatically turned off.

IMPORTANT The sensor cannot detect the presence of fog; switch the lights on manually in this case.

CLEANING THE WINDOWS

WINDSCREEN WASHER/WIPER

The device can only work when the ignition key is at **MAR**.

The right hand stalk can take up five different positions:

A windscreen wiper off

B flick operation.

With the lever in position **B**, turn the knurled ring **F** to select one of four different speeds for the intermittent operation mode:

= very slow flick

-- = slow flick

--- = medium flick

---- = fast flick

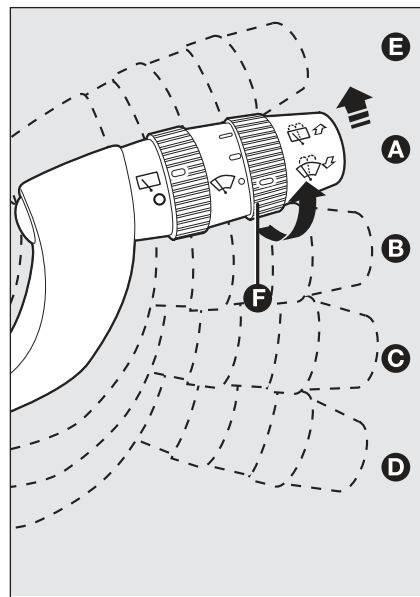

fig. 69

L0C0073m

C continuous slow

D continuous fast

E temporary fast operation (unstable position).

Operation in position E is limited to the time during which the lever is kept in that position manually. When released, the stalk will return to position A and the wiper will be automatically stopped.

IMPORTANT Replace wiper blades as specified in the “Maintenance and care” chapter.

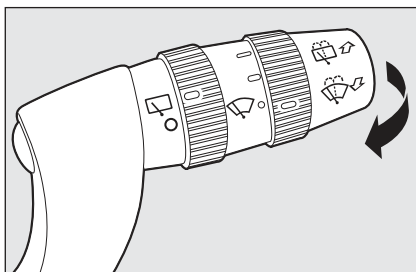

fig. 70

L0D0074m

“Smart washing” function

Pull the stalk towards the steering wheel (unstable position) to operate the windscreen washer.

Keeping the stalk pulled for more than half a second, with just one movement it is possible to operate the washer jet and the wiper at the same time.

The jet will be released immediately when the wiper stops after four flicks.

A further stroke after 5 seconds completes the wiping operation.

RAIN SENSOR

(for versions/markets, where provided)

The rain sensor is located behind the driving mirror in contact with the windscreen and has the purpose of automatically adjusting the frequency of the windscreen wiper strokes as to the rain intensity.

IMPORTANT Keep clean the glass in the sensor area.

Activation

Move the right stalk down by one click.

The activation of the rain sensor is signalled by a control acquisition flick.

Turn the ring **F-fig. 71** to increase the rain sensor sensitivity.

The increase of the sensitivity of the rain sensor is signalled by a control and acquisition flick.

The smart cycle is started when the windscreen wiper is turned on while the rain sensor is active without supplementary flick after 5 seconds. The sensor will resume normal automatic operation.



Do not use the windscreen wiper to remove layers of snow or ice from the windscreen. In such conditions, the windscreen wiper may be subjected to excessive stress and the motor protection which prevents operation for a few seconds may trip. If rear window wiper operation is not reset, contact a Lancia Dealership.

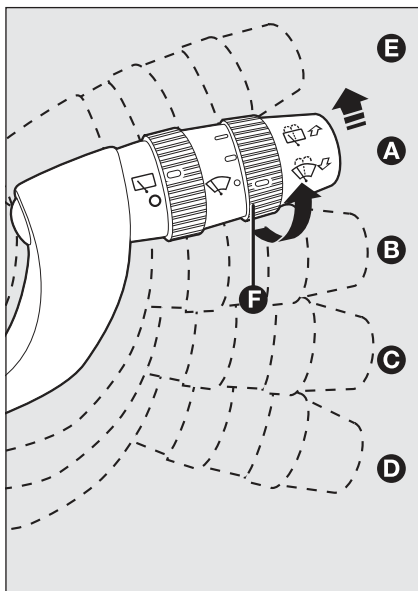

fig. 71

LOC0073m

Deactivation

Move the lever from position **B** or turn the ignition key to **STOP**.

At the next start-up (key at **MAR**), the sensor will not be reactivated even if the stalk is at **B**. To activate the sensor, move the stalk to position **A** or **C** and then to position **B** or turn the sensitivity adjustment knurled ring.

The wiper will flick once to indicate that the sensor has been reactivated.

The rain sensor is able to recognize and automatically adjust itself in the presence of the following particular conditions:

- dirt on the controlled surface (salt, dirt, etc.);
- difference between day and night.



WARNING

Streaks of water may cause undesired blade moving.

REAR WINDOW WIPER/ WASHER fig. 72

The device can only work when the ignition key is at **MAR**.

Turn ring **A** from position **O** to position  to open the rear window wiper as follows:

- in flick mode when the windscreen wiper is not running

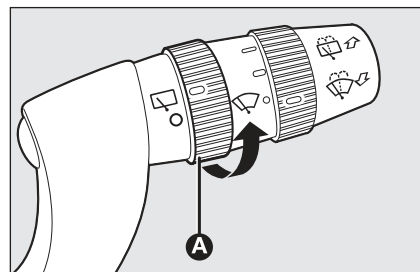

fig. 72

LOD0075m

- in synchronous mode (at half the frequency of the windscreen wiper) when the windscreen wiper is running.

The rear window wiper will run in continuous mode when the windscreen wiper is running and reverse gear is engaged.

Pull the stalk towards the dashboard (unstable position) to operate the rear window washer.

Hold the stalk pushed for longer than half a second to operate the rear window wiper as well.

Smart wash function is activated as for the windscreen wiper when the stalk is released.

CRUISE CONTROL

(for versions/markets, where provided)

It is a device able to support the driver, with electronic control, which allows driving at speed over 30 km/h on long and straight dry roads (e.g.: motorways), at a desired speed, without pressing the accelerator pedal. Therefore it is not suggested to use this device on extra-urban roads with traffic. Do not use it in towns.

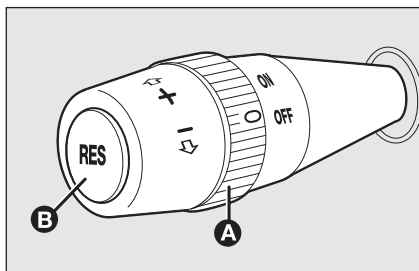

fig. 73

L0D0076m

TURING THE DEVICE ON

Turn the ring **A-fig. 73** to **ON**.

The device can only be turned on in 4th or 5th gear. Travelling downhill with the device engaged, the car speed may increase more than the memorised one. When the device is activated the warning light turns on together with the relevant message on the instrument panel (for versions/markets, where provided).

STORING THE SPEED

Proceed as follows:

- turn ring **A-fig. 73** to **ON** and press the accelerator pedal to the required speed;
- push the lever upwards (+) for at least 3 seconds, then release it: the car speed will be stored. The accelerator pedal may be released.

If needed (e.g. for overtaking), press the accelerator pedal to accelerate: the car will return to the previously set speed when the pedal is released.

RESTORING THE STORED SPEED

If the device has been disengaged, for example by pressing the brake or clutch pedal, the memorized speed can be reset as follows:

- accelerate gradually until reaching a speed approaching the stored speed;
- engage the gear selected when the speed was stored (4th or 5th gear);
- press **RES B**.

INCREASING THE STORED SPEED

The stored speed can be increased in two ways:

- by pressing the accelerator and then storing the new speed reached;

or

- by moving the stalk upwards (+).

Each operation of the stalk will correspond to a slight increase in speed (about 1 km/h), while keeping the stalk upwards will correspond to a continuous speed increase.

REDUCING THE STORED SPEED

This can be carried out in two ways:

- by turning the device off and then storing a new speed;
- or
- by moving the stalk downwards (–) until reaching the new speed which will be stored automatically.

Each operation of the stalk will correspond to a slight reduction in speed (about 1 km/h), while keeping the stalk downwards will correspond to a continuous speed reduction.

TURNING THE DEVICE OFF

Turn ring **A-fig. 73** to **OFF** or the ignition key to **STOP**. The device is automatically turned off in one of the following cases:

- when the brake pedal or clutch is pressed.



WARNING

When travelling with the device on, never set the gearshift lever to neutral.



WARNING

If the device is faulty, turn ring A to OFF, check the fuse and contact a Lancia Dealership.

CEILING LIGHTS

FRONT CEILING LIGHT

fig. 74

Switch **A** turns these lights on/off.

With switch **A** in central position, lights **C** and **D** will turn on/off when opening/closing the front doors.

With switch **A** pressed on the left side, lights **C** and **D** will always stay off.

With switch **A** pressed on the right side, lights **C** and **D** will always stay on.

The lights will be turned on/off gradually.

Switch **B** is used for operating the spot light function; it works as follows (light off):

- light **C** if the left side is pressed;
- light **D** if pressed on the right side.

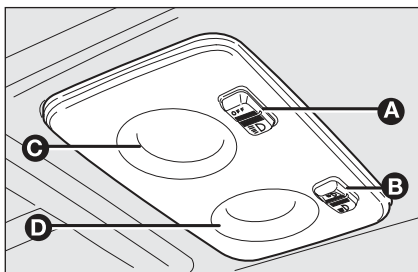

fig. 74

L0D0077m

IMPORTANT Before getting out of the vehicle, make sure the switch is at central position: lights off with doors closed in order to avoid draining the battery.

In any case, if the switch is left inadvertently to the on position, the lights will turn off automatically 15 minutes after turning the engine off.

Courtesy light timing

On certain versions to facilitate getting in/out of the car at night or with poor lighting, 2 different timed switching on modes have been provided.

Lights when getting into the car

Lights will be turned on as follows:

- for about 10 seconds when the door is unlocked;
- for about 3 minutes when a door is opened;
- for about 10 seconds when the doors are closed (within the three minutes).

Timing will stop when turning the ignition key to **MAR**.

Light when getting out of the car

After removing the key from the ignition switch, the lights will turn on as follows:

- within 2 minutes from turning the engine off for about 10 seconds;
- when a door is opened for about 3 minutes;
- for about 10 seconds when the doors are closed (within the three minutes).

Timing will stop automatically when locking the doors.

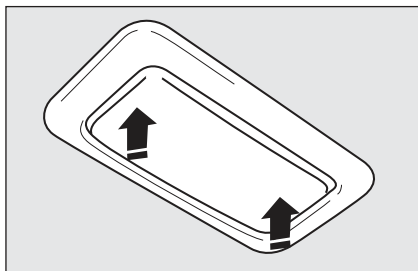

fig. 75

LOD0078m

REAR COURTESY LIGHT

The light will turn on/off by pressing the lens rightwards or leftwards as shown in **fig. 75**.

The light may be integrated in the ceiling unit, where provided.

Two 5W ceiling lights **fig. 76** are present if a sunroof is fitted.

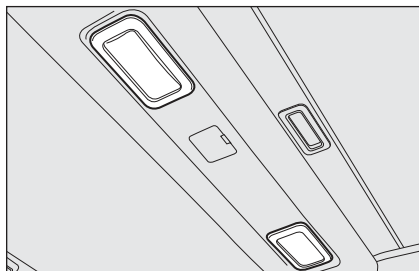

fig. 76

LOD0254m

Ceiling light timer

(for versions/markets, where provided)

On certain versions to facilitate getting in/out of the car at night or with poor lighting, 2 different timed switching on modes have been provided.

Lights when getting into the car

Lights will be turned on as follows:

- for about 10 seconds when the door is unlocked;
- for about 3 minutes when a door is opened;
- for about 10 seconds when the doors are closed (within the three minutes).

Timing will stop when turning the ignition key to **MAR**.

Light when getting out of the car

After removing the key from the ignition switch, the lights will turn on as follows:

- within 2 minutes from turning the engine off for about 10 seconds;
- when a door is opened for about 3 minutes;
- for about 10 seconds when the doors are closed (within the three minutes).

Timing will stop automatically when locking the doors.

HAZARD LIGHTS

EMERGENCY LIGHTS fig. 77-78

Press the toggle switch A in any position of the ignition switch to turn the lights on.

When the device is on, the switch is flashing and warning lights \leftarrow and \rightarrow on the cluster come on.

Press the switch again to turn the lights off.

FRONT FOG LIGHTS fig. 79

(for versions/markets, where provided)

To turn front fog lights on, press button D , to activate these lights it is necessary to have the side/tail lights switched on.

Press the button again or turn off the side/tail lights to turn the lights off.

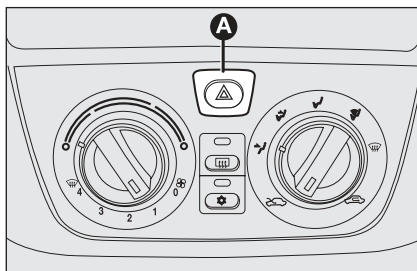

fig. 77

L0D0080m

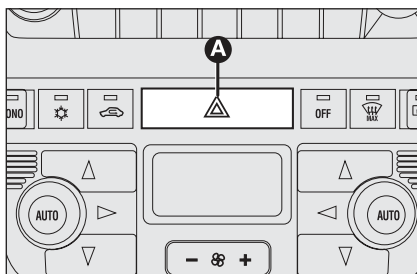

fig. 78

L0D0081m

WARNING

The use of hazard lights is governed by the Highway Code of the country you are in. Keep to the rules.

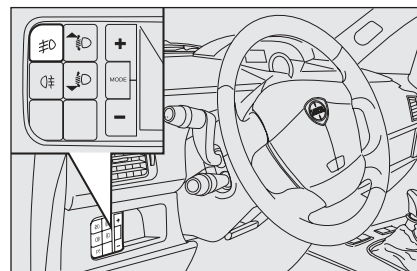

fig. 79

L0D0385m

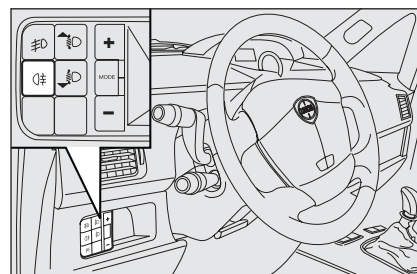

fig. 80

L0D0386m

REAR FOG LIGHTS fig. 80

Press button D to turn on with the dipped beam or fog lights on.

Press the button again or turn off the dipped beam headlights or the fog lights to turn the lights off.

FUEL CUT OFF SWITCH

The switch is located on the bottom of the car, near the pillar on passenger side. Move the carpet aside to reach the switch. It is tipped by a crash and cuts off the fuel feed, thus stopping the engine.

When the device is activated the warning light  turns on together with the relevant message on the reconfigurable multifunctional display (for versions/markets, where provided).

Inspect the car carefully for fuel leakages (e.g. in the engine compartment), under the car or near the fuel tank.

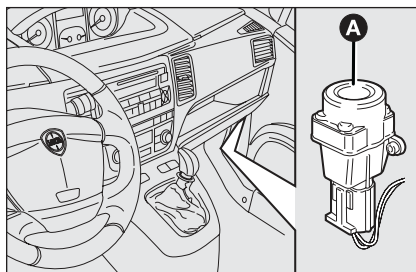

fig. 81

L0D0388m

Press button **A-fig. 81** to reactivate the fuel feed system if no leakage is found and the car is worthy of resuming travel.

After the accident, remember to turn the ignition key to **STOP** to prevent draining the battery.



WARNING

If, after a crash, you smell fuel or see leaks from the fuel system, do not reset the switch to avoid fire risk.

INTERIOR EQUIPMENT

UPPER ODDMENT COMPARTMENTS **fig. 82-83**

To open the compartments, release the lid using device **A** and lift to the stable opening position.



WARNING

Do not travel with the compartments open: they could cause injury in case of an accident.

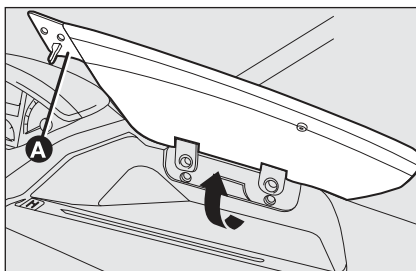

fig. 82

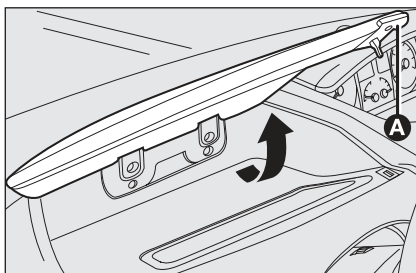

fig. 83

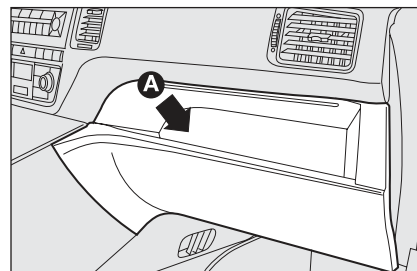

fig. 84

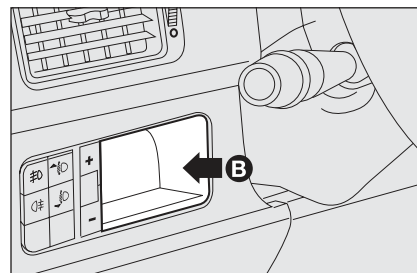

fig. 85

ODDMENT COMPARTMENTS

Compartment **A-fig. 84** is located on the dashboard facing the front passenger.

Compartment **A** may contain an extractable oddment bag **E-fig. 87** which can be ordered from Lineaccessori Lancia.

Compartment **B-fig. 85** is located on the dashboard on the left of the steering wheel.

Compartment **C-fig. 86** and the DIN compartment **D-fig. 86**, in the dashboard, are located in central position.

The DIN compartment **D** can be extracted to fit a Lineaccessori Lancia sound system.

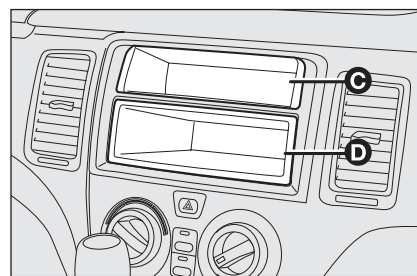

fig. 86

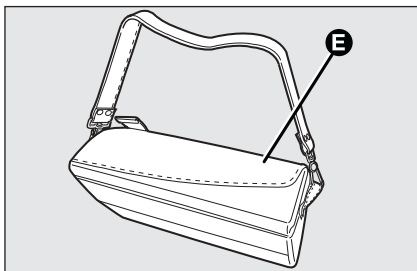

fig. 87

L0D0343m

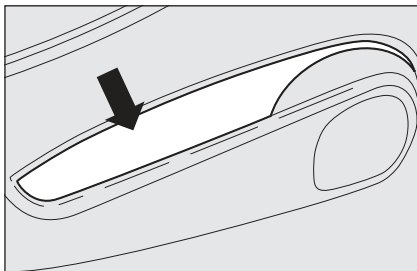

fig. 88

L0D0153m

DOOR POCKETS fig. 88

Paper/map pockets are located in door panels.

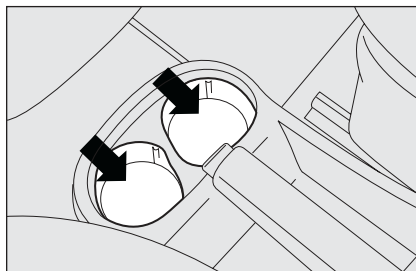

fig. 89

L0D0091m

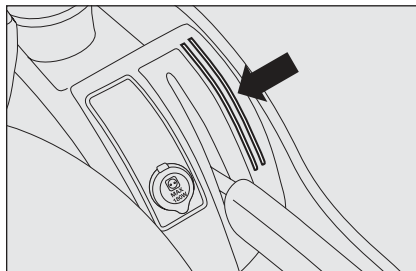

fig. 90

L0D0092m

CUP HOLDER – CAN HOLDER fig. 89

The cup/can holders – are located on the central tunnel near the hand-brake.

CARD HOLDER fig. 90

The central tunnel has recesses to keep telephone cards, magnetic cards and tickets.

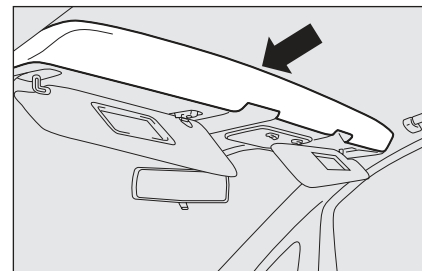

fig. 91

L0D0093m

ODDMENT SHELF ON ROOF fig. 91

The shelf is designed to contain easily retrievable light items (e.g. papers, maps, etc.).

IMPORTANT Do not place heavy objects on the shelf. Do not use it as a grip.

The shelf is alternative to the sunroof.

REAR COMPARTMENT CD HOLDER WITH CAN HOLDER fig. 92

There is a CD holder and cup holder on the central tunnel behind the handbrake.

POWER SOCKETS (12V)

They only work with the ignition key at **MAR**.

Socket **A-fig. 93** is located in front position. Socket **A** is replaced by a cigar lighter in cars with smoker's kit. For versions/markets, where provided, the car may be equipped with power socket **C-fig. 94** also on the left of the boot.

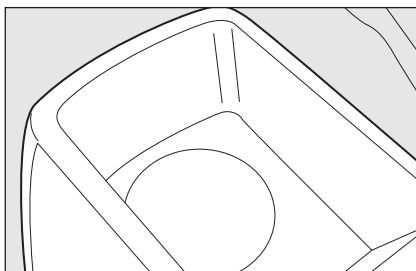

fig. 92

L0D0236m

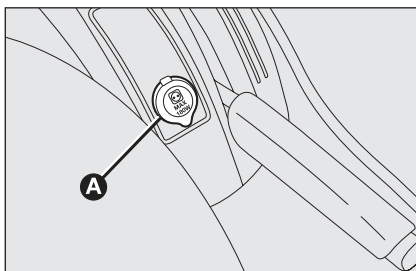

fig. 93

L0D0236m

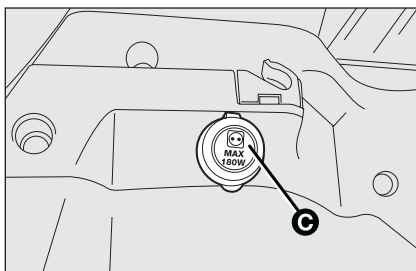

fig. 94

L0D0095m

SMOKER'S KIT

(for versions/markets, where provided)

Cigar lighter fig. 95

It is located on the central console by the side of the handbrake.

Press the button with the ignition switch at **MAR**. The button will automatically return to the initial position after approximately 15 seconds and the cigar lighter is ready for use.

IMPORTANT Always check that the cigar lighter has turned itself off.

Ashtray fig. 96

The ashtray is a removable plastic box that can be fitted into the glass/can recesses on the central tunnel.

IMPORTANT Do not use the box as an ashtray and a waste paper basket at the same time: it might set on fire in contact with cigarette stubs.

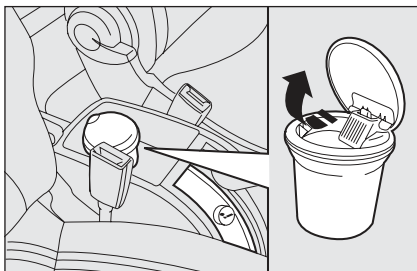

fig. 95

L0D0096m

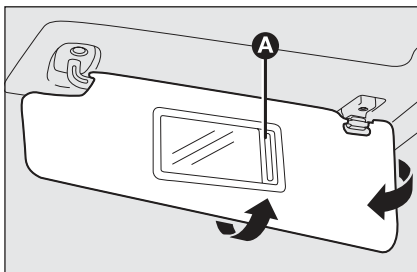

fig. 96

L0D0097m

**WARNING**

The cigar lighter becomes very hot. Handle with care. The device must not be used by children: risk of fire and/or burns.

SUN VISORS

These are arranged at the sides of the internal rearview mirror. They may be oriented frontally and to the side.

A courtesy mirror can be applied to the back of sun visors, according to the version.

To use the mirror, open the sliding flap **A**-fig. 96 (for versions/markets, where provided).

SUNROOF

(for versions/markets, where provided)

The sun roof has an anti-pinch safety system capable of detecting the presence of an object whilst the roof is closing; when this happens the system stops and the glass travel is immediately reversed. The large “Skydome” sunroof consists of two glass panels, one fixed and one mobile, with sun curtains which can be opened and closed manually. The sun roof can only be operated with the ignition key in the **MAR** position. The button near the front ceiling lights is used to open and close the roof.

To open

Hold button **B**-fig. 97 pressed: the front glass panel will go to spoiler position. Hold **B** pressed again for longer than half a second to move the roof automatically to end of travel position. Press the button again to stop the roof in an intermediate position.

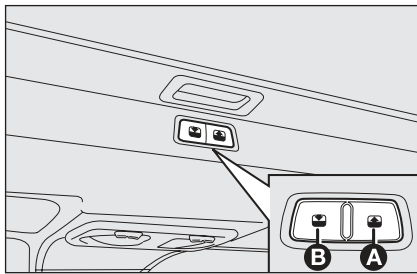

fig. 97

L0D0098m

To close

From the all open position, hold **A-fig. 101** pressed for longer than half a second to take the roof automatically to spoiler position. Press the button again to stop the roof in an intermediate position. Hold **A** pressed until the panel closes completely.

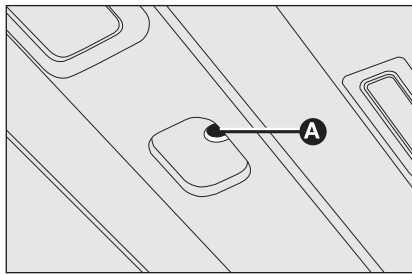

fig. 98

L0D0099m

EMERGENCY OPERATION

If the switch fails, the sunroof can be moved manually proceeding as described below:

- remove the protective cap on the internal upholstery between the two sun curtains.
- take the socket wrench provided
- introduce the socket in **A-fig. 98** and turn it:
 - clockwise, to open the roof
 - anticlockwise, to close the roof.



It is advisable to use the sunroof in the spoiler position only if a crosswise roof rack is used.



Do not open the sun roof in the presence of snow or ice: it may be damaged.



WARNING

When leaving the car, always remove the key from the ignition device to avoid the risk of injury due to accidental operation of the sun roof; it presents a risk to those left on board: improper use of the roof can be dangerous. Before operation, always check that no-one is at risk of being injured by the moving sun roof or by objects getting caught and dragged by it.

POWER

WINDOWS

The two-button version (front windows only) is not automatic. The four-button version (front and rear windows) has an automatic opening and closing feature: the passenger window will open automatically (and close automatically, for versions/markets, where provided); the rear windows may open automatically.

IMPORTANT With ignition key at **STOP** or removed, the power windows remain activated for about 2 minutes and are deactivated immediately the moment a door is opened.

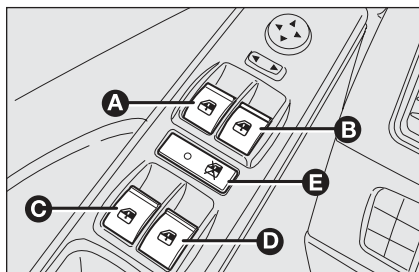

fig. 99

LOD0103m

DRIVER'S DOOR fig. 99

There are two or five switches (the latter for versions/markets, where provided) on the arm rest for operating the following with the key at **MAR**:

- A opening/closing the left front window
- B opening/closing the right front window

- C opening/closing the left rear window (for versions/markets, where provided)
- D opening/closing the right rear window (for versions/markets, where provided)
- E turn off the rear door switches (for versions/markets, where provided). The button in the LED will light up when the device is on.

Automatic continuous operation

(for versions/markets, where provided)

For some versions with four power windows, the front window (driver's side) can be opened and closed automatically while the other windows can be opened automatically.

A Button for automatically opening and closing

B-C-D Buttons for automatic opening only.

Hold one of the buttons pressed for a short time to open the window in steps. The window will stop when the button is released.

PASSENGER AND REAR DOORS

fig. 100

(for versions/markets, where provided)

The switch operating the corresponding window is located on the internal armrest of each door.

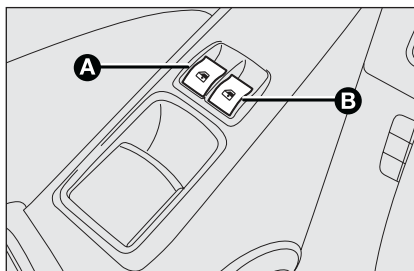



fig. 100

L0D0103m



WARNING

Incorrect use of the power windows may be dangerous. Before operation, always check that no-one is exposed to the risk of being injured by directly by the moving window or objects getting caught and dragged. When leaving the car, always remove the key from the ignition device to avoid the risk of injury due to accidental operation of the power windows.

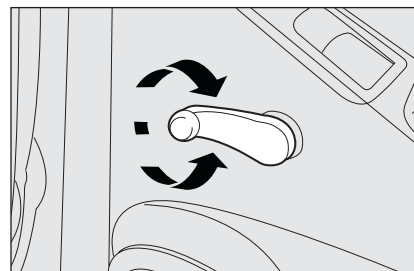

fig. 101

L0D0156m

MANUAL

(for versions/markets, where provided)

Operate the corresponding handle **fig. 101** to open/close the window.

BOOT

The tailgate can only be opened from the outside using the electric handle **A-fig. 102**.

The tailgate can be opened at any time, even if the doors are locked.

The “Key” option can be activated in the instrument panel display setup menu (see “Reconfigurable multi-functional display” in this chapter): the tailgate will not be unlocked with the doors in this case. Press button  on the remote control.

The direction indicators will blink twice when the tailgate is opened.

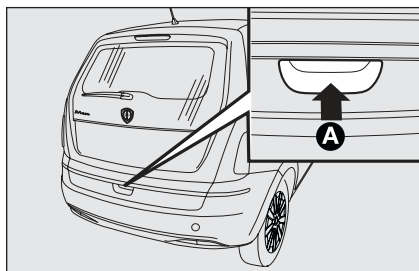

fig. 102

L0D0390m

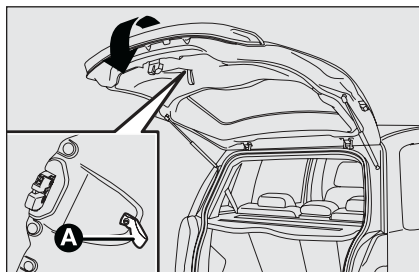

fig. 103

L0D0391m

CLOSING TAILGATE

Lower the tailgate using handle **A-fig. 103** as shown in the figure and then press the tailgate until you hear it click.

IMPORTANT If the “Key” option is selected, make sure that you have the ignition key before closing the tailgate because it will be automatically locked.



Do not fit additional objects onto the rear window shelf or tailgate (speakers, spoilers, etc.) except when contemplated by the manufacturer to ensure the correct operation of the side gas shock absorbers of the tailgate itself.



WARNING

Never exceed the maximum allowed load in the boot (see “Technical Specifications”). Make sure that the objects are well arranged in the boot so that they will not be projected forwards following sudden braking.



WARNING

Never travel with objects on the rear window shelf: they cause injury to passengers in the event of an accident or sudden braking.

EXTENDING THE BOOT WITH FIXED SEAT

Proceed as follows:

- ❑ fasten the buckles to the tabs (shown by the arrows) on the backrest **fig. 104**;
- ❑ check that each of the two side seat belts **C-fig. 105** is inserted in the corresponding seat belt guide **D**;
- ❑ raise the cushion **A** as shown in the figure ;
- ❑ release the backrest, by moving the levers **B** then fold it forward to obtain a flat loading surface.

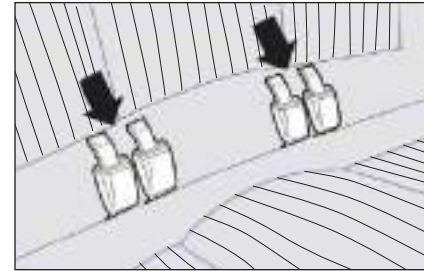

fig. 104

L0D0428m

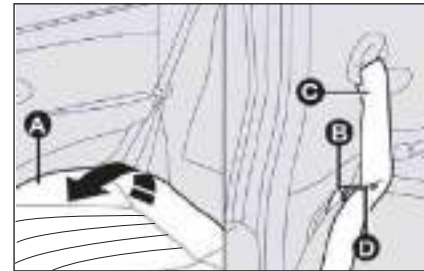

fig. 105

L0D0429m

BONNET

OPENING

Proceed as follows:

- pull lever **A**-fig. 106 in the direction of the arrow;
- move lever **B**-fig. 108 in the direction of the arrow;
- lift the bonnet and at the same time release the rod **C**-fig. 107 from the catch, then fit end **D** of the rod into the bonnet recess **E**.

IMPORTANT Before opening the bonnet, check that windscreen wiper arms are not lifted from the windscreen.

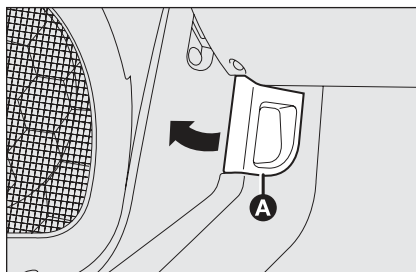

fig. 106

L0D0113m

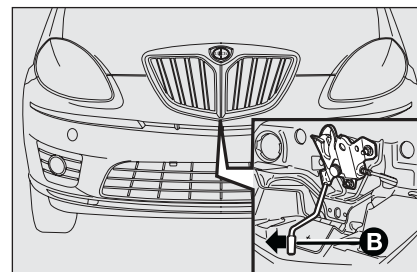

fig. 108

L0D0392m

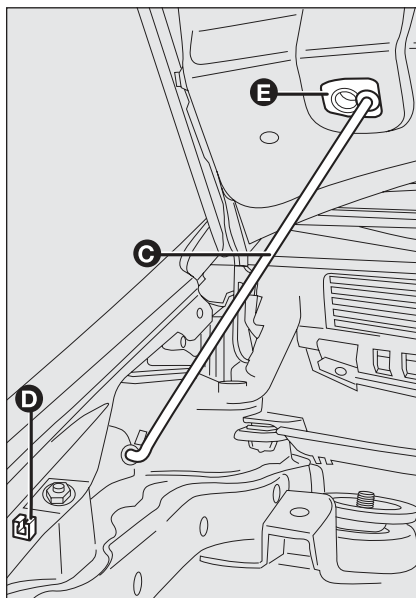

fig. 107

L0C0115m



WARNING

The bonnet must always be perfectly closed while travelling for reasons of safety. Make sure that the bonnet is perfectly closed and that the lock is engaged. If you discover that the bonnet is not perfectly closed while travelling, stop immediately and close the bonnet in the correct manner.

CLOSING fig. 107

Proceed as follows:

- ❑ hold the bonnet up with one hand and with the other remove rod C from recess and fit it back into its catch D;
- ❑ lower the bonnet to approximately 20 centimetres from the engine compartment and let it come down. Make sure that the bonnet is completely closed and not only fastened by the safety catch by trying to open it. If it is not perfectly closed, open the bonnet and repeat the procedure. Do not simply press it.

IMPORTANT Always check that the bonnet is closed properly to avoid its opening while the car is travelling.



WARNING

The bonnet may drop suddenly if the supporting rod is not in correct position.



WARNING

Perform these operations when the car is stationary only.

ROOF BARS

(for versions/markets, where provided)

IMPORTANT Use of Lineaccessori Lancia roof bars is recommended. Follow the instructions contained in the assembly kit to the letter. Assembly must be performed by qualified personnel.

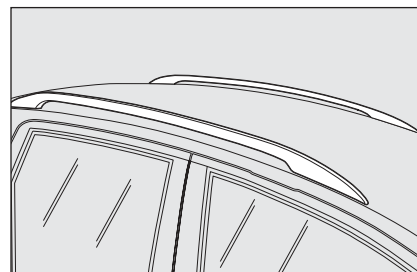

fig. 109

L0D0248m

IMPORTANT Never exceed the permitted weight (see section “Technical specifications”).

Check that the attachment fastening screws are correctly positioned after a few kilometres.

HEADLIGHTS

BEAM DIRECTION

Correction direction of the headlights is essentially for the comfort and safety of the driver and the other road users. The headlights must be correctly directed to ensure the best visibility conditions when the headlights are on. Contact Lancia Dealership to have the headlights properly adjusted.

HEADLIGHT CORRECTOR

This device works with the key at **MAR** and the dipped beam headlights on. The car will slant backwards when it is loaded, raising the light beam. The beams must therefore be directed again in this case.



Never operate the sunroof when roof bars are fitted.

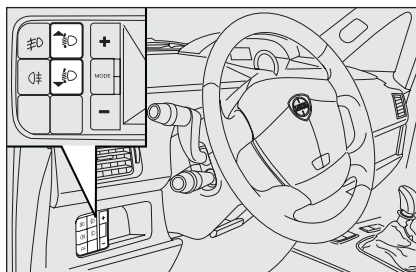



fig. 110

Adjusting headlight alignment fig. 110

To adjust, press buttons  and  on the control panel. The display shows the positions during the adjustment operation.

Position **0** - one or two occupants on front seats. - Position **1** - five occupants - Position **2** - five people + load in the boot - Position **3** - driver + maximum permitted load all in boot.

IMPORTANT Check beam alignment every time the load carried changes.

HEADLIGHT ADJUSTMENT WHEN TRAVELLING ABROAD fig. 111-112

The dipped headlamps are adjusted for service in the country where the car was originally purchased.

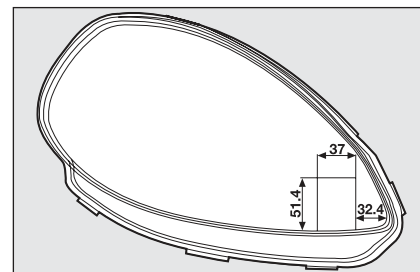

fig. 111

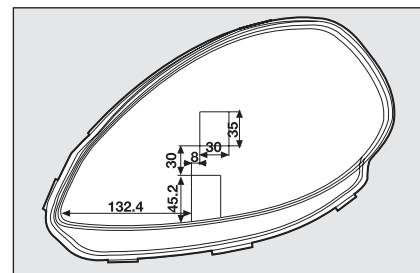

fig. 112

When travelling in countries on the other side of the road, cover the headlight as shown in the figure. Use non-transparent adhesive for this purpose. The figures show how to change from left-hand drive to right-hand drive.

ABS SYSTEM

The car is fitted with an ABS braking system, which prevents the wheels from locking when braking, makes the most of road grip and gives the best control when emergency braking under difficult road conditions.

System is completed by EBD (Electronic Braking force Distribution), which distributes the braking action between front and rear wheels.

IMPORTANT The braking system needs to settle for approximately 500 km: during this time, avoid sudden, repeated and prolonged braking.



WARNING

The ABS exploits the tyre-road grip at the best, but it cannot improve it; you should therefore take every care when driving on slippery surfaces without taking unnecessary risks.

SYSTEM INTERVENTION

Intervention of the ABS is detected by a slight pulsing of the brake pedal accompanied by noise: such an event indicates that you need to adjust your speed to the type of road on which you are travelling.

MECHANICAL BRAKE ASSIST (emergency braking assistance)

(for versions/markets, where provided)

This system (which cannot be deactivated) recognises emergency braking conditions according to the speed of operation of the brake pedal and provides an additional hydraulic braking pressure to support that provided by the driver. This allows faster and more powerful operation of the braking system.

IMPORTANT When the Mechanical Brake Assist is activated noises can be heard from the system. This is normal. Anyway, while braking keep the brake pedal depressed.

FAILURE INDICATIONS

ABS failure

ABS failure is indicated by the turning on of warning light  on the instrument panel together with the dedicated message on the multifunctional display (for versions/markets, where provided), (see section “Warning lights and messages”).



In the case, the braking system will work as normal without the extra potentials offered by the ABS system. Drive carefully to the nearest Lancia Dealership to have the system checked.



WARNING

When the ABS intervenes it means that you are approaching the grip limit between tyres and road: slow down to exploit all the available grip.

EBD failure

ABS failure is indicated by the turning on warning lights  and  on the instrument panel together with a message on the multifunctional display (for versions/markets, where provided), (see section “Warning lights and messages”).

In this case, the rear wheels may suddenly lock and the car may swerve. Drive carefully to the nearest Lancia Dealership to have the system checked.



WARNING

When the ABS cuts in, and you feel the brake pedal pulsating, do not remove your foot, but keep it pressed; in doing so you will stop in the shortest amount of space possible under the current road conditions.



WARNING

If warning light  only lights up on the instrument panel (with a message on the multifunctional display; for versions/markets, where provided), stop the car immediately and go to the nearest Lancia Dealership. Leakage of hydraulic fluid from the braking system will compromise functionality of the braking system, either of the conventional type or with ABS.

EOBD SYSTEM

The EOBD system (European On Board Diagnosis) allows continuous diagnosis of the components of the car correlated with emissions.

It also alerts the driver, by turning on the warning light  on the instrument panel (together with relevant message on the multifunctional display, for versions/markets, where provided) (see section “Warning lights and messages”), when these conditions are no longer in peak conditions.



The objective is:

- to keep the system efficiency under control;
- warn when a fault causes emissions levels to increase;
- to signal the need to replace deteriorated components.

The system also has a diagnostic connector that can be interfaced with appropriate tools, which makes it possible to read the error codes stored in the control unit, together with a series of specific parameters for engine operation and diagnosis. This check can also be carried out by the traffic police.

IMPORTANT After eliminating the inconvenience, to check the system completely, Lancia Dealerships are obliged to run a bench test and, if necessary, road tests which may also call for a long journey.



Go to a Lancia Dealership as soon as possible if warning light  either does not light up when the key is turned to MAR to if while travelling the warning lights comes on either steady or blinking (along with a message on the multifunctional display, where provided). The operation of warning light  may be checked by the traffic police using specific devices. Follow the laws in force in the country where you are driving.

GSI SYSTEM (for versions with mechanical gearbox only)

(for versions/markets, where provided)

The gear shift indication makes it possible, on cars with a manual gearbox, to suggest the driver should change gear (higher gear: shift up, see **Fig. a** or lower gear: shift down, see **Fig. b**), through a dedicated indication in the control panel. This suggestion to change gear is designed to improve consumption and ensure the best driving style.

NOTE: the indication in the instrument panel remains on until the driver makes a gear change or until the driving conditions return to a situation where a gear change is not required to improve consumption.



fig. a

fig. b

SOUND SYSTEM

(for versions/markets, where provided)

Refer to the supplement to this Owner's Handbook for operating the sound system with CD or with CD MP3.

SOUND SYSTEM SETUP

(for versions/markets, where provided)

The system consists of:

- sound system power wires
- front and rear speaker power wires
- aerial power wire
- 2 tweeters on front pillars (30W max power each);
- 2 mid-woofers on front doors (165 mm diameter, 30W max power each);
- 2 full-range speaker on front doors (165 mm diameter, 30W max power each).

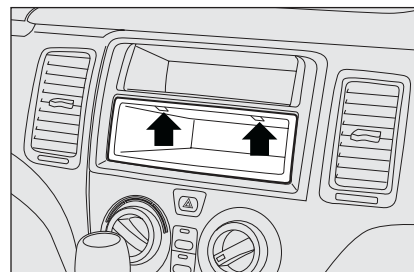

fig. 113

L0D0120m

Sound system installation

The sound system must be installed in the space occupied by the central oddment compartment where the wiring leads. To extract the compartment, press in the points shown at the retainer systems.



It is advisable to have the sound system and interference filter installed by a Lancia Dealership.

MOBILE PHONE SETUP

(for versions/markets, where provided)

The mobile phone setup with CD or CD MP3 sound system consists of:

- a dual function aerial (sound system + phone 900/1800 MHz) located on the roof;
- connection cables to the dual function sound system and wiring with 10 pin connector.

The connector is located between the steering column and the central unit.



The hands-free kit must be purchased by the customer because it must be compatible with the customer's mobile phone. It is advisable to install the microphone near the front ceiling light.



WARNING

The maximum applicable power to the aerial is 20W.



WARNING

For installing the mobile phone and connecting to system setup in the car, contact Lancia Dealership to prevent any trouble that could impair car safety.



WARNING

Be very careful when fitting non-standard additional spoilers, light alloy wheels or wheel cups: they could reduce brake ventilation and consequently brake efficiency in the case of repeated, violent braking or on long downhill roads. Make sure that nothing obstructs the pedal stroke (mats, etc.)

ACCESSORIES PURCHASED BY THE OWNER

If after buying the car, you decide to install electrical accessories that require a permanent electric supply (alarm, satellite antitheft system, etc.) or accessories that in any case burden the electric supply, contact Lancia Dealership, whose qualified personnel, besides suggesting the most suitable devices belonging to Lineaccessori Lancia, will also evaluate the overall electric consumption, checking whether the car's electric system is able to withstand the load required, or whether it needs to be integrated with a more powerful battery.

ELECTRICAL/ELECTRONIC DEVICE INSTALLATION

Electric and electronic devices installed after buying the car by after-market service must carry the following label:



Fiat Auto S.p.A. authorises the installation of transceiving devices provided that they are installed according to rules of good engineering practice respecting the manufacturer's indications by a specialised centre.

IMPORTANT Traffic police may not allow the car on the road in the event of assembly of devices which imply modifications to the features of the car. This may also cause lapse of warranty in relation to faults caused by the change or either directly or indirectly related to it.

Fiat Auto S.p.A. shall not be liable for damage caused by the installation of accessories either not supplied or recommended by Fiat Auto S.p.A. and/or installed in compliance with the provided instructions.

TRANSCIVERS AND MOBILE PHONES

Radio transmitter equipment (vehicle mobile phones, CB radios, amateur radio etc.) shall not be used inside the car unless a separate aerial is mounted on the roof.

IMPORTANT The use of similar devices inside the passenger compartment (without separated aerial) produces radio-frequency electromagnetic fields which, amplified by the resonance effects inside the passenger compartment, may cause electrical systems equipping the car to malfunction. This could compromise safety in addition to constituting a potential hazard for the passengers.

In addition, transmission and reception of these devices may be affected by the shielding effect of the car body.

As concerns EC-approved mobile phones (GSM, GPRS, UMTS), strictly comply with the instructions for use provided by the mobile phone's manufacturer.

“DUAL DRIVE” ELECTRIC POWER STEERING SYSTEM

The car is provided with an electric power steering system which only works with the key at **MAR** and the engine running. The system called “Dual drive” allows to customise the effort required to turn the steering wheel according to driving conditions.

ON/OFF (CITY function)

Press **fig. 118** in the central part of the dashboard to turn the function on and off.

The message **CITY** appears on the multifunctional display when the function is on.

With the **CITY** function the effort on the steering wheel is lighter, thus facilitating parking manoeuvres: this is particularly useful when driving in towns.

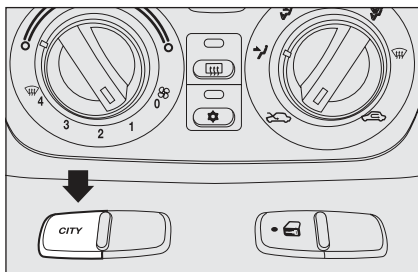



fig. 114

L0D0419m

**WARNING**

Under no circumstances should aftermarket operations involving steering system or steering column modifications (e.g.: installation of anti-theft device) be carried out that could badly affect performance and safety. This also causes the warranty to become null and void and results in vehicle non-compliance with type-approval requirements.

FAILURE INDICATIONS

Electric power steering failure is indicated by the turning on of warning light  on the instrument panel together with the dedicated message on the multifunctional display (where provided), (see section “Warning lights and messages”).

The car can be driven using the mechanical steering in case of failure to the electric power steering system. Take the car to a Lancia Dealership as soon as possible.

IMPORTANT The steering may be before stiffer when parking requiring a lot of steering. This is normal and caused by the electric control motor overheating system. No repairs are needed. The power steering system will start working properly again the next time the car is used.

**WARNING**

Before starting any maintenance operation, stop the engine and remove the key from the ignition switch to operate the steering lock, particularly when the car is lifted off the ground. If this is not possible (i.e. if the key must be kept in the MAR position or the engine must be kept running), remove the main electric power steering system fuse.

PARKING SENSORS

(for versions/markets, where provided)

Parking sensors are located in the rear bumper and their function is to inform the driver, through an intermittent buzzer, about the presence of obstacles behind the car.

ACTIVATION

The sensors are automatically activated when the reverse gear is engaged. As the distance from the obstacle behind the car decreases, the acoustic alarm becomes more frequent.

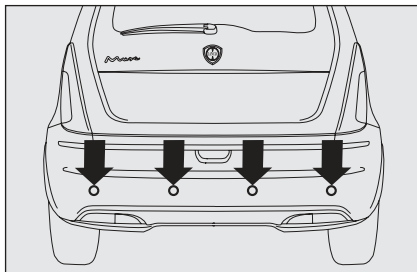

fig. 115

L0D0395m

BUZZER WARNINGS

When the reverse gear is engaged an intermittent acoustic signal is automatically activated.

The acoustic signal:

- becomes louder as the reduction of distance between the car and the obstacle decreases;
- becomes continuous when the distance between the car and the obstacle is less than 30 cm and stops immediately if the distance raises;
- is constant if the distance is unvaried; if this situation concerns the side sensors, the buzzer will stop after about 3 seconds to avoid, for example, warning indications in the event of manoeuvres along walls.

Detection distances

The central range of action varies according to the version: the range is equal to 140 cm and to 70 cm for small sized obstacles (or round parking posts). The side action range is 60 cm.

If several obstacles are detected by the sensors, only the nearest one is considered.

FAILURE INDICATIONS

See the “Warning lights and messages” chapter.

OPERATION WITH TRAILER

The system is deactivated automatically when the trailer electric cable plug is fitted into the car tow hook socket.

The sensors are automatically enabled again when the trailer cable plug is removed.

GENERAL WARNINGS

- When parking, take the utmost care to obstacles that may be set above or under the sensors.
- Objects set close to the car, under certain circumstances are not detected and could therefore cause damages to the car or be damaged.
- indications sent by the sensors can be altered by dirt, snow or ice deposited on the sensors or by ultrasound systems (e.g.: truck pneumatic brakes or pneumatic hammers) set nearby the car.



It is vital that the sensors are always clean in order for the system to work properly. Take great care when cleaning the sensors not to scratch or damage them; avoid using dry, rough or hard cloths. Clean the sensors with clean water with the addition of car shampoo if necessary. In washing stations, clean the sensors quickly, keeping the steam jet/high pressure washing nozzles at least 10 cm away from the sensors.



WARNING

The driver is always and only responsible for parking and other dangerous manoeuvres. Always make sure that there are no people, animals or objects in the way when carrying out these manoeuvres. Parking sensors are designed to assist drivers: in all cases, you must always pay the utmost attention during potentially dangerous manoeuvres, even when these are carried out a low speed.

REFUELLING

PETROL ENGINES

Use only unleaded petrol.

To avoid mistakes, the diameter of the fuel filler is too small to introduce the beak of a leaded petrol pump. The petrol octane rating (RON) must not be lower than 95.

IMPORTANT An inefficient catalyst leads to harmful exhaust emissions, thus contributing to air pollution.

IMPORTANT Never use leaded petrol, even in small amount or in an emergency, as this would damage the catalyst beyond repair.

MULTIJET ENGINES

Operation at low temperatures

If the outside temperature is very low, the diesel thickens due to the formation of paraffin clots with consequent defective operation of the fuel supply system.

In order to avoid these problems, different types of diesel are distributed according to the season: summer type, winter type and arctic type (cold/mountain areas). If refuelling with diesel fuel whose features are not suitable to the temperature of use, it is advisable to mix TUTELA DIESEL ART additive in the proportions shown on the container with the fuel. Pour the additive into the tank before the fuel.

When using or parking the car for a long time in the mountains or cold areas, it is advisable to refuel using locally available fuel.

In this case, it is also advisable to keep the tank over 50% full.

FILLING THE TANK

To fill the tank completely, top-up twice after the pump switches off. Further top-ups could cause faults in the fuel feeding system.



For diesel engines, use diesel fuel for motor vehicles compliant with EN590 European specifications only. The use of other products or mixtures may damage the engine beyond repair and consequently cause lapse of warranty in relation to the damage caused. If you accidentally introduce other types of fuel in the tank, do not start the engine and empty the tank. If the engine has run also for a very short time, you will need to have the entire fuel feed system emptied in addition to the tank.

FUEL TANK CAP

The fuel flap is opened by the door locking system. Therefore, if the doors are locked, press **D-fig. 117** to open the fuel flap.

The cap **C-fig. 116** has a device **B** securing it to the flap **A** so that is cannot be misplaced. To open the cap **C** turn it anticlockwise and extract.

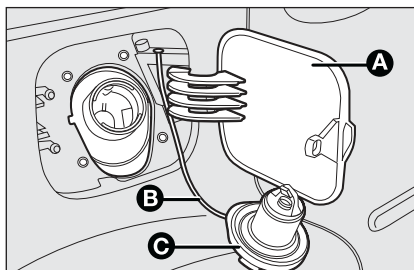

fig. 116

L0D0399m

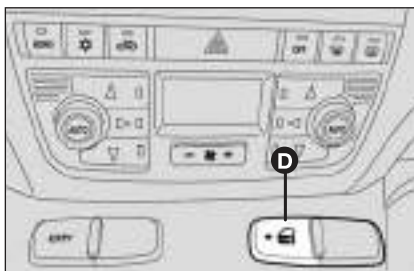

fig. 117

L0D0420m

The fuel cap **A-fig. 118** is key-lockable and has a catch (for versions/markets, where provided) to prevent misplacing it **B** that fastens it to the flap then use the ignition key to turn counter-clockwise and remove the cap.

When refuelling, hook the cap to the device on the inner flap, as illustrated.

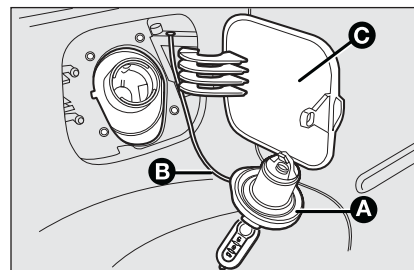

fig. 118

L0D0500m

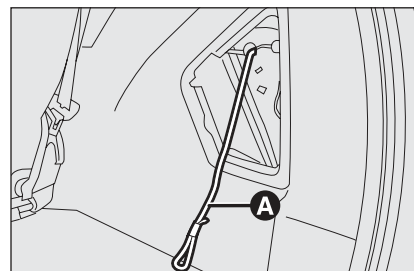

fig. 119

L0D0490m

OPENING THE FUEL CAP IN AN EMERGENCY

In case of emergency, pull the cord **A-fig. 119** to open the fuel flap.

Remove the protection to reach the cord.

When refuelling, fasten the cap to the device inside the flap as shown in the diagram.

IMPORTANT The airtight sealing of the tank may cause a slight vacuum. A suction noise when you release the cap is therefore entirely normal.

After refuelling, fasten the cap by turning it clockwise until you hear it click, then turn the key clockwise and remove the key from the flap.



WARNING

Do not approach naked flames or lit cigarettes to the fuel filler: fire risk. Keep your face away from the fuel filler to prevent breathing in harmful vapours.

PROTECTING THE ENVIRONMENT

The devices for curtailing petrol engine emissions are the following:

- three-way catalytic converter;
- Lambda sensor;
- fuel evaporation system.

In addition, do not let the engine run, even for a test, with one or more spark plugs disconnected.

The devices for reducing diesel fuel engine emissions are the following:

- oxidising catalytic converter;
- exhaust gas recirculation system (E.G.R.);
- diesel particulate filter (DPF)

DPF (DIESEL PARTICULATE FILTER)

(for 1.3 Multijet 90 HP - 1.3 Multijet 95 HP versions)

The Diesel Particulate Filter is a mechanical filter, integral with the exhaust system, that physically traps particulates present in the exhaust gases of Diesel engines. The diesel particulate filter has been adopted to eliminate almost totally particulates in compliance with current / future law regulations. During normal use of the vehicle, the engine control unit records a set of data (e.g.: travel time, type of route, temperatures, etc.) and it will then calcu-

late how much particulates has been trapped by the filter. Since this filter physically traps particulate, it should be regenerated (cleaned) at regular intervals by burning carbon particles. The regeneration procedure is controlled automatically by the engine management control unit according to the filter conditions and vehicle use conditions. The following phenomena may occur during the regeneration: limited increase of idle speed, activation of electric fan, limited increase of smoke, high temperatures at the exhaust. These are not faults; they do not impair vehicle performance or damage the environment. If the dedicated message is displayed, refer to section "Warning lights and messages".



WARNING

The catalytic converter develops high temperature during operation. Do not park on grass, dry leaves, pine needles or other flammable material: fire risk.

SAFETY

SEAT BELTS	96
PRETENSIONERS	99
CARRYING CHILDREN SAFELY	101
“UNIVERSAL ISOFIX” CHILD RESTRAINT ASSEMBLY SETUP	105
FRONT AIRBAGS	108
SIDE AIRBAG (Side bags - Front Window bags).....	110



SEAT BELTS

USING THE FRONT AND SIDE REAR SEAT BELTS

The belt should be worn keeping the chest straight and rested against the seat back.

To fasten the seat belts, take hold of the tongue **A**-fig. 1 and insert it into the buckle **B**, until hearing the locking click.

On removal, if it jams, let it rewind for a short stretch, then pull it out again without jerking.

Press button **C** to release the belt. Accompany the belt while it is being re-wound to prevent twisting.

Through the reel, the belt automatically adapts to the body of the passenger wearing it, allowing freedom of movement.

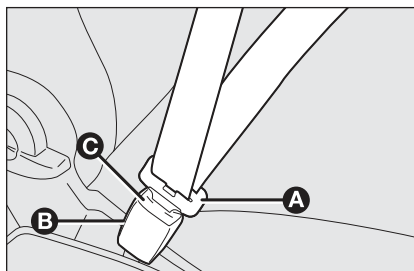

fig. 1

LOD0126m

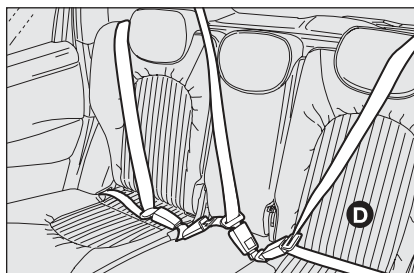

fig. 2

LOD0430m

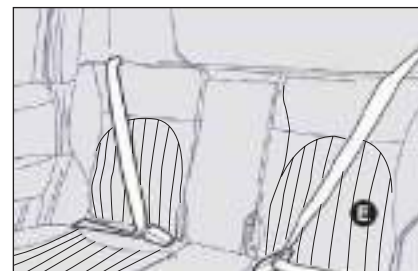

fig. 3

LOD0431m

Rear seat belts must be worn as shown in diagram **D**-fig. 2 (five seat versions) or as shown in diagram **E**-fig. 3 (four seat versions).



WARNING

Never press button C-fig. 1 when travelling.

The reel may lock when the car is parked on a steep slope: this is perfectly normal. Furthermore, the reel mechanism locks the belt if it is pulled and in the event of sudden braking, collisions and on high speed bends.

The rear seat is fitted with inertial seat belts with three anchor points and reel.

S.B.R. system

The car is fitted with a Seat Belt Reminder system (S.B.R.), consisting of a buzzer and a flashing warning light  on the instrument panel which warns the driver that the seat belt must be fastened.

The buzzer can be deactivated (until the next engine stop) as follows:

- fasten the driver's seat belt;
- turn the ignition key to **MAR**;
- wait for over 20 seconds and then release one of the seat belts.

For permanent deactivation, contact a Lancia Dealership.

The S.B.R. can only be reactivated using the setup menu (see the "Warning lights and messages" chapter, "Seat belt reminder" paragraph).

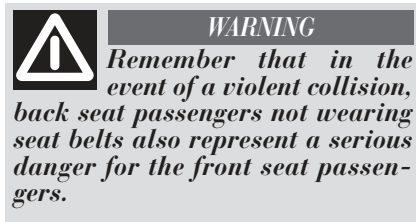

ADJUSTING THE FRONT SEAT BELT HEIGHT

(for versions/markets, where provided)

Always adjust the seat belt height to the passenger's body: this precaution may considerably reduce the risk of injury in the event of a collision.

Correct regulation is obtained when the belt passes approximately half way between the shoulder and the neck.

To adjust, move the grip **A**-**fig. 4** of the locking mechanism either up or down and at the same time move the ring **B** to the most suitable of the allowed positions.

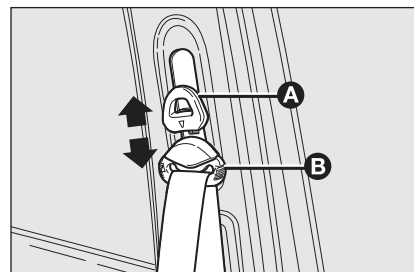
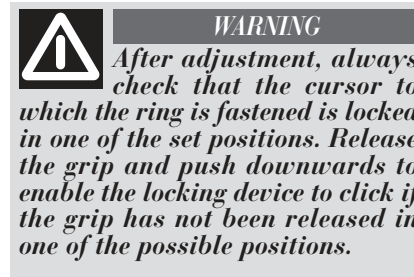
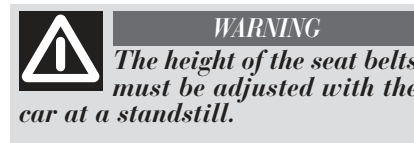

fig. 4

L0D0128m



USING THE MIDDLE SEAT BELT

The seat belt is provided with a double buckle and fastening tab.

To prepare the seat belt for use, extract the tabs from seat **H** and **P**-fig. 5 of the winder and pull the seat belt, making the webbing run. Avoid twisting and tugging. Then insert tab **G**-fig. 6 into the buckle **L** with button **M**.

To use the belt, make the webbing run further and insert the fastening tab **I**-fig. 6 in the seat of the buckle **N**.

To release the belt: press button **O**-fig. 6 and accompany the belt as it winds back to prevent twisting.

Expanding the boot: release the buckle by pressing **M**-fig. 6 and accompany the belt to prevent it from twisting. Position the tab **I** in the seat **P**-fig. 5 and the tab **G**-fig. 6 in the seat **H**-fig. 5 in the winder.

IMPORTANT Arrange the seat belt for use as described above after repositioning the seats.

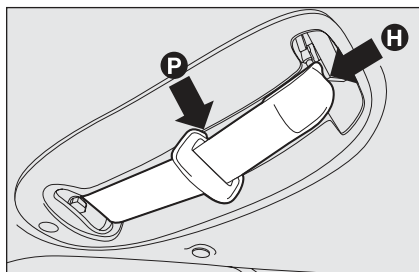

fig. 5

L0D0311m

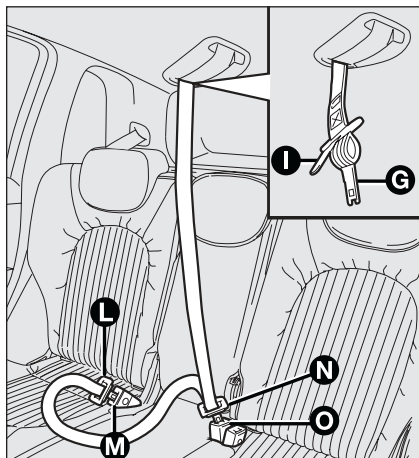

fig. 6

L0D0310m



WARNING

Remember that in the event of a violent collision, back seat passengers not wearing seat belts also represent a serious danger for the front seat passengers.

PRETENSIONERS

To increase the efficiency of the seat belts, the car is fitted with pretensioners. These devices, in the event of a violent crash, rewind the seat belts a few centimetres. In this way they ensure that the seat belt adheres perfectly to the wearer before the restraining action begins.

The seat belt locks to indicate that the device has intervened; the seat belt cannot be drawn back up even when guiding it manually.

IMPORTANT To obtain the highest degree of protection from the action of the pretensioner, wear the seat belt keeping it firmly close to the chest and pelvis. A slight amount of smoke may be detected during operation of the pretensioners. This smoke is not harmful and does not indicate a fire.

The pretensioner does not require any maintenance or lubrication.

Anything that modifies its original conditions invalidates its efficiency.

If due to unusual natural events (floods, seas storm, etc.) the device has been affected by water and mud, it must necessarily be replaced.



WARNING

The pretensioner can only be used once. Go to a Lancia Dealership to have it replaced after it has been deployed. The expiration date of the device is shown on the label inside the upper oddment compartment on passenger side: go to a Lancia Dealership to have the device replaced when the expiration date approaches.



Operations which lead to knocks, vibrations or localised heating (over 100°C for a maximum of 6 hours) in the area around the pretensioners may cause damage or trigger them. These devices are not affected by vibrations caused by irregularities of the road surface or low obstacles such as kerbs, etc. Contact a Lancia Dealership for any assistance.

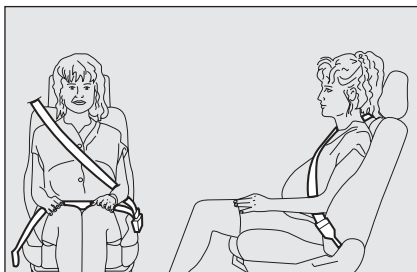

fig. 7

L0D0133m

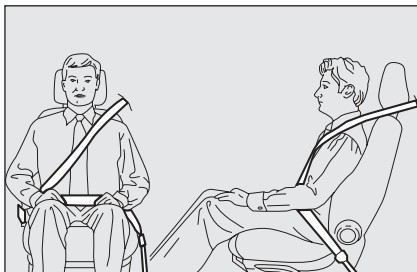

fig. 8

L0D0134m

LOAD LIMITERS

To increase passenger's safety, the front seat belt reels contain a load limiter which allows controlled sag in such a way as to dose the force acting on the chest and shoulders during the belt restraining action in case of front crash.



fig. 9

L0D0135m

GENERAL INSTRUCTIONS FOR USING THE SEAT BELTS

The driver is responsible for respecting and ensuring that all the other occupants of the car also respect the local laws in force in relation to the use of seat belts. Always fasten the seat belts before starting off.

Seat belts must also be used by pregnant women: risk will be significantly reduced for both the expectant mother and the child in the event of an accident.

Of course they must position the lower part of the belt very low down so that it passes under the abdomen, see fig. 7).



WARNING

The belt must not be twisted. The upper part must cross the shoulder and the chest diagonally. The lower part must adhere to the hips not to the abdomen. Do not use devices (clips, etc.) to hold the seat belt away from your body.



WARNING

For maximum safety, keep the back of your seat upright, lean back into it and make sure the seat belt fits closely across your chest and hips. Always fasten the seat belts on both the front and the rear seats. Travelling without seat belts will increase the risk of severe injury and even death in the event of an accident.



WARNING

Never disassemble or tamper with the seat belt or pretensioner components. All interventions must be performed by qualified and authorised personnel only. Always go to a Lancia Dealership



WARNING

If the belt has been subjected to heavy stress, for example after an accident, it should be changed completely together with the anchors, anchor fastening screws and the pretensioners. In fact, even if the belt has no visible defects, it could have lost its resilience.



WARNING

Each seat belt may only be used by one person at a time: do not carry children on your lap with one seat belt protecting both. In general, do not place any objects between the person and belt.

HOW TO KEEP THE SEAT BELTS ALWAYS IN EFFICIENT CONDITIONS

- ❑ Always use the belt with the tap taut and never twisted; make sure that it is free to run smoothly.
- ❑ Replace the belt after a serious accident even if it does not appear damaged. Always replace the belt if the pretensioners were deployed.
- ❑ To clean the belt, wash by hand with water and mild soap, rinse and leave to dry in the shade. Do not use strong detergents, bleach, paints or any other substance which could damage the belt fibres.
- ❑ Keep the reels dry: correct operation may only be ensured if the reels are dry.
- ❑ Replace the seat belt when showing significant wear or cut signs.

CARRYING CHILDREN SAFELY

For optimum protection in the event of a crash, all passengers must be seated and wearing adequate restraint systems.

This is even more important for children.

This prescription is compulsory in all EC countries according to EC Directive 2003/20/EC.

A child's head is larger and heavier in proportion to its body and the child's muscular and bone structures are not fully developed. For this reason, they require restraint systems which are different from those used by adults to protect them in the event of an accident.

The research results in relation to the best protection for children is illustrated in European Regulation EEC-R44 which divides the restraint systems into five groups in addition to making their use compulsory:

- Group 0 up to 10 kg of weight
- Group 0+ up to 13 kg of weight
- Group 1 9-18 kg of weight
- Group 2 15-25 kg of weight
- Group 3 22-36 kg of weight

As it may be noted, the groups overlap partly and in fact, there are devices that cover more than one weight group.

All child restraint devices must bear the certification data, together with the control brand, on a solidly fixed label which must absolutely never be removed.

When over 1.50 m in height, from the point of view of restraint systems, children are considered as adults and have to wear the standard seat belts.

Lineaccessori Lancia includes child restraint systems for each weight group. These devices are recommended having been specifically designed for Lancia cars.



WARNING

SEVERE DANGER: Do not arrange child seats facing backwards on the front seat if the passenger's airbag is enabled. Deployment of the airbag in an accident could cause fatal injuries to the baby. It is advisable to carry children on the rear seat, which is the most protected position in the event of an accident. Child seats must not be fitted on the front seat of cars fitted with a passenger air bag, whose deployment in an accident could cause fatal injuries to the baby regardless of the seriousness of the impact.



WARNING

In case of need, the passenger airbag can be deactivated and children can be placed on the front seat. It is very important to check that the airbag has been deactivated by means of the amber warning light (see the chapter on first and side airbags, specifically the paragraph on passenger front airbags). Move the passenger's seat as far back as possible to avoid contact between the child seat and the dashboard.



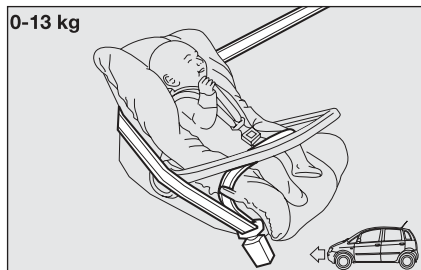

fig. 10

L0D0136m

GROUP 0 and 0+ (fig. 10)

Babies up to 13 kg must be carried facing backwards on a cradle seat, which, supporting the head, does not induce stress on the neck in the event of sharp deceleration.

The cradle is held in place by the car seat belts and in turn it must restrain the child with its own belts.



WARNING

The figure is indicative for assembly purposes only. Refer to the instructions supplied with the child restraint.

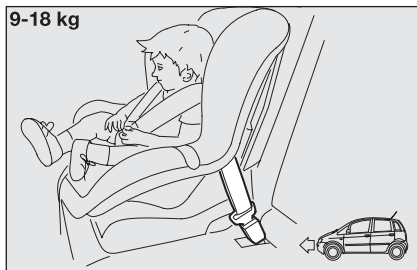

fig. 11

L0D0501m

GROUP 1 (fig. 11)

Starting from 9 kg to 18 kg in weight, children may be carried facing forwards.



WARNING

The figure is indicative for assembly purposes only. Refer to the instructions supplied with the child restraint.

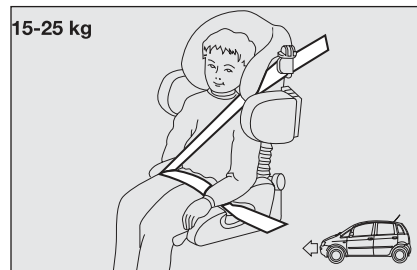

fig. 12

L0D0138m

GROUP 2 (fig. 12)

Children from 15 to 25 kg may use the car seat belts directly. The child seat is only needed to position the child correctly with respect to the belts so that the diagonal section crosses the child's chest and never the neck and is snug on the hips not the abdomen.



WARNING

The figure is indicative for assembly purposes only. Refer to the instructions supplied with the child restraint.

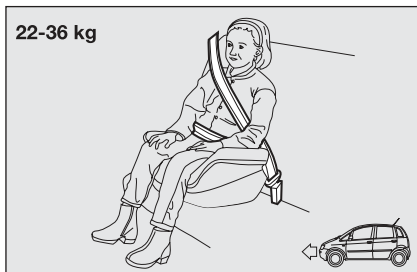

fig. 13

GROUP 3 fig. 13

For children between 22 kg and 36 kg, there are boosters allowing the seatbelt to fit correctly.

The figure shows proper child seat positioning on the rear seat.

Children taller than 1.50 m can wear seat belts like adults.

**WARNING**

The figure is indicative for assembly purposes only. Refer to the instructions supplied with the child restraint.

SUITABILITY OF PASSENGER SEATS FOR CHILD SEAT USE

The car complies with the new European Directive 2000/3/EC which governs the arrangement possibilities for child restraints on the various seats of the car as shown in the following table:

Group	Weight group	CAR SEAT		
		Passenger front	Passenger rear side	Passenger central (for versions/markets, where provided)
Group 0, 0+	up to 13 kg	U	U	*
Group 1	9 -18 kg	U	U	*
Group 2	15 -25 kg	U	U	*
Group 3	22 -36 kg	U	U	*

Key:

U = suitable for child restraint systems of the “Universal” category, according to European Standard EEC-R44 for the specified “Groups”.

* Never mount child restraint systems on the rear central seat.

Below is a summary of the rules of safety to be followed for carrying children:

- ❑ The recommended position for installing child's seat is on the rear seat, as it is the most protected in the case of a crash.
 - ❑ If the passenger's air bag is deactivated always check the amber warning light  on the cluster to make sure that it has actually been deactivated.
 - ❑ Carefully follow the instructions supplied with the child restraint system which are mandatory by law. Keep the instructions in the car along with the other papers and this handbook. Do not use child seats without instructions.
 - ❑ Always check the seat belt is well fastened by pulling the webbing.
- ❑ Only one child is to be strapped to each retaining system.
 - ❑ Always check the seat belts do not fit around the child's throat.
 - ❑ While travelling, do not let the child sit incorrectly or release the belts.
 - ❑ Never carry children on your lap, even newborns. No-one, however strong, can hold a child in the case of an accident.
 - ❑ In case of an accident, replace the child's seat with a new one.



WARNING

Never arrange a child restraint seat on the front seat in presence of a passenger airbag because children must never travel on the front seat.

“UNIVERSAL ISOFIX” CHILD RESTRAINT ASSEMBLY SETUP

(for versions/markets, where provided)

The car is provisioned for a Universal Isofix child restraint, a new European standardised system for carrying children safely.

An example of such a seat is shown in **fig. 14**.

The Universal Isofix child seat covers weight group 1.

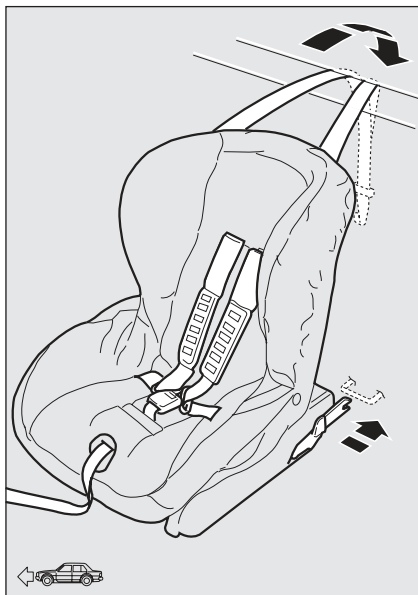

fig. 14

LOC0425m

Due to its different anchoring system, an Isofix child restraint must be anchored to the proper lower metal rings **A**-fig. 15, between rear seat back and cushion. The upper belt (provided with the child restraint) must be then secured to ring **D**-fig. 16 set in the boot at child's seat level.

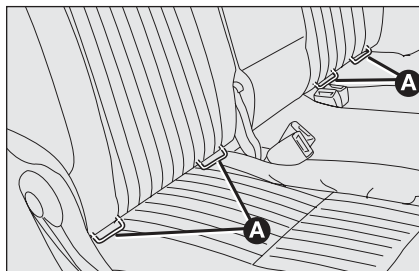

fig. 15

LOC0140m

It is possible to have a mixed assembly of the traditional child seats and the Universal Isofix ones.

Remember that in case of Universal Isofix child restrain systems, you can only use all those seats approved with the marking ECE R44/03 "Universal Isofix".

The Universal Isofix "Duo Plus" child seat and the special "G 0/1" seat are available from Lineaccessori Lancia.

For any further details on installation/use, refer to the instruction manual for the child seat.

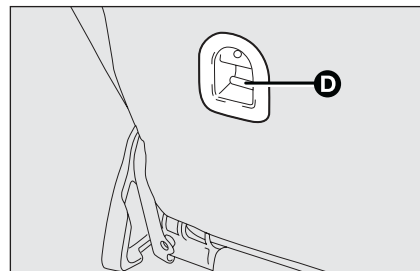

fig. 16

LOC0143m

**WARNING**

Fit the child seat when the car is stationary. The child seat is correctly anchored to the brackets when you hear the click. Follow the instructions for assembly, disassembly and positioning that the manufacturer must supply with the child seat.

PASSENGER SEAT COMPLIANCE FOR USING UNIVERSAL ISOFIX CHILD SEATS

The table below shows the different installation possibilities of Universal Isofix restraint systems on the seats fitted with Isofix fasteners, in accordance with European standard ECE 16.

Weight group	Orientation seat	Isofix position class	Isofix size side rear
Group 0 to 10 kg	Facing backwards	E	IL
	Facing backwards	E	IL
Group 0+ up to 13 kg	Facing backwards	D	IL
	Facing backwards	C	IL (*)
	Facing backwards	D	IL
Group I to 9 up to 18 kg	Facing backwards	C	IL (*)
	Facing forwards	B	IUF
	Facing forwards	B1	IUF
	Facing forwards	A	IUF

IUF suitable for Isofix child restraint systems to be set facing forwards, universal class (fitted with third upper fastener), approved for the weight group.

IL: suitable for special child restraint systems. Isofix type suitable and tested for this type of car. The seat may be installed by moving the front seat forward.

(*) Arrange the Isofix seat with the front seat in all up position.

FRONT AIRBAGS

The car is provided with front airbags for the driver and passenger and window bags (head protection system). It may be provided with optional front side bags.

The front driver / passenger air bags have been designed to protect the occupants in the event of head-on crashes of medium-high severity, by placing the cushion between the occupant and the steering wheel or dashboard.

Front air bags are designed to protect car's occupants in front crashes and therefore non-activation in other types of collisions (side collisions, rear shunts, roll-overs, etc.) is not a system malfunction.

An electronic control unit will make the bag inflate in the event of a frontal crash.

The bag will inflate instantaneously placing itself between the front occupant's body and the structures which could cause injury. It will deflate immediately afterwards.

Driver and passenger front airbags are not a replacement of but complementary to the belts, which you are recommended to always wear, as specified by law in Europe and most non-European countries.

In the event of a collision, a person not wearing a seat belt may be thrown forward and come into contact with the bag before it has fully opened. The protection offered by the cushion is reduced in such a case.

Front air bag may not be activated in the following situations:

- in collisions against highly deformable objects not affecting the car front surface (e.g. bumper collision against guard rail, etc.);
- jamming of the car underneath other vehicles or protective barriers (e.g. underneath a truck or a guard rail); in this case, the bags would offer no additional protection with respect to the seat belt and their deployment is unnecessary. No deployment in such cases is consequently not the sign of a fault.

The front airbags (driver and passenger) are designed and calibrated to protect front seat occupants who are wearing seat belts. The volume of front air bags at max. inflation fills most of the space between the steering wheel and the driver and between the dashboard and the passenger.

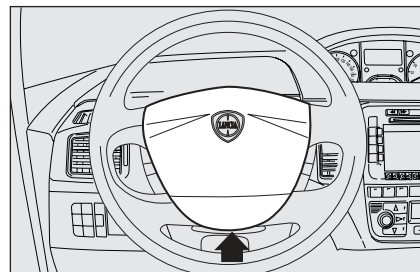

fig. 17

L0C0416m

FRONT AIR BAG ON DRIVER'S SIDE, fig. 17

It consists of an instant-inflating cushion contained in a special recess in the centre of the steering wheel.

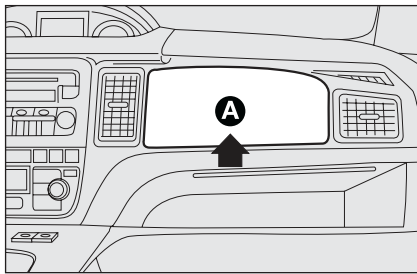

fig. 18

L0C0145m

FRONT AIR BAG ON PASSENGER'S SIDE fig. 18

It consists of an instant-inflating cushion contained into a special recess **A** in the dashboard, this cushion has a volume bigger than that of the driver. The airbags are not deployed in the event of collisions of low severity (for which the withholding action of the seat belts is sufficient). For this reason, the seat belt must be worn at all times. During side collisions the seat belts hold passengers in the correct position and prevent ejection from the vehicle during very violent collisions.



WARNING

Do not apply stickers or other objects on the steering wheel in zone A-fig. 18, passenger side airbag cover or side upholstery on roof. Do not place objects on the passenger side dashboard because these could interfere with the correct opening of the airbag (e.g. mobile phones) and cause severe injury to occupants.



WARNING

***SEVERE DANGER:** Do not arrange child seats facing backwards if the passenger's front airbag is on. Deployment of the airbag in an accident could cause fatal injuries to the baby.*



WARNING

If the car is provided with a front passenger airbag, deactivate the airbag when arranging a child restraint seat on the front seat. Move the passenger's seat as far back as possible to avoid contact between the cradle and the dashboard. Although this is not mandatory by law, the airbag should be immediately re-activated when children are no longer carried to ensure better protection to adults.



MANUAL DEACTIVATION OF PASSENGER'S FRONT AIRBAG AND SIDE BAG

(for versions/markets, where provided)

Whenever a child needs to be carried on the front seat, the passenger's front airbag and the Side Bag (for versions/markets, where provided) must be deactivated.

The instrument panel warning light  will stay on glowing steadily until reactivating the passenger's front air bag and the side bag (for versions/markets, where provided).



WARNING

To deactivate the passenger's front air bag and the side bag (for versions/markets, where provided), refer to "Multi-functional display" paragraph in the "Dashboard and controls" chapter.

SIDE BAGS (Side bags - Window bags)

(for versions/markets, where provided)

SIDE BAGS fig. 19

(for versions/markets, where provided)

The side bags are arranged in the front seat backrests and inflate instantly to protect the chest of occupants in case of medium-to-high severity crashes.



WARNING

Do not cover the backrest of the front seats with covers which are not suitable for use with side bags.

Lancia Dealership has covers suitable for seats with side bags.

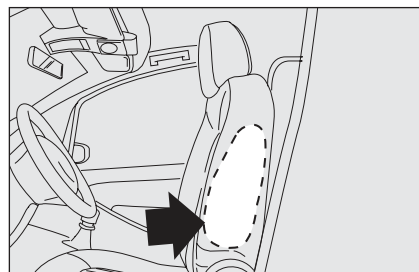

fig. 19

L0C0147m

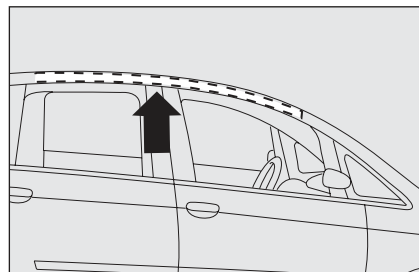

fig. 20

L0C0148m

WINDOW BAGS fig. 20

(for versions/markets, where provided)

It is formed by two "curtain" window bags are located behind the side roof upholstery and are covered by special trimming. They were designed to protect the head of front and rear passengers in case of side collisions, thanks to the wide cushion inflation surface.

Side bags are not a replacement of but complementary to the belts, which you are recommended to always wear, as specified by law in Europe and most non-European countries.

IMPORTANT In the event of side crash, you can obtain the best protection by the system keeping a correct position on the seat, allowing thus a correct window bag unfolding.

IMPORTANT The front air bags and/or side bags may be deployed if the car is subject to heavy knocks or accidents involving the underbody area, such as for example violent shocks, against steps, kerbs or low obstacles, falling of the car in big holes or sags in the road.

IMPORTANT A small amount of dust will be released when the airbags are deployed. The dust is not harmful and does not indicate the beginning of a fire. Furthermore, the surface of the deployed bag and the interior of the car may be covered in a dusty residue: this dust may irritate the skin and the eyes. Wash with mild soap and water in the event of exposure.

The airbag system expires after 14 years (charge) and 10 years (clock contact). Go to a Lancia Dealership to have the devices replaced when the expiration date approaches.

IMPORTANT Should an accident occur in which any of the safety devices is activated, take the car to a Lancia Dealership to have the devices activated replaced and to have the system checked.

All inspection, repair and replacement operations concerning the air bags must only be carried out at a Lancia Dealership.

If you are having the car scrapped, have the air bag system deactivated at a Lancia Dealership first. If the car changes ownership, the new owner must be informed of the method of use of air bags and the above warnings and also be given this “Owner’s Handbook”.

IMPORTANT Pretensioners, front airbags and front side bags are deployed according to different logics on the basis of the type of collision. Non deployment of one of the devices does not therefore indicate a system fault.



WARNING

Do not rest your head, arms or elbows on the door, on the windows and in the window bag area to prevent injury in case of deployment.

Never lean head, arms and elbows out of the window.

GENERAL WARNINGS



WARNING

If when turning the key to MAR the warning light  does not turn on or if it stays on when travelling (together with the message on the multifunctional display, for versions/markets, where provided) there could be a failure in safety systems; in this event air bags or pretensioners may not be deployed in case of impact or, in a minor number of cases, they be deployed accidentally. Contact Lancia Dealership immediately to have the system checked.

Do not cover the backrest of the front seats with covers which are not suitable for use with side bags.

**WARNING**

Always drive holding your hands on the steering wheel rim so that the airbag can inflate freely in the case of need. Do not drive with your body bent forward. Keep your back straight against the back rest. Have the airbag system checked by a Lancia Dealership if the car was stolen, if theft was attempted, or if the car was subjected to vandalism or flooding.

**WARNING**

Airbags may be deployed if another vehicle crashes if the key is inserted and at MAR also if the engine is not running and the car is stationary. For this reason, children must never sit on the front seat, even if the car is not moving. On the other hand, if the key is inserted and at STOP, none of the safety devices (airbag or pretensioners) will be deployed in a collision. Non deployment of the devices in this case does not indicate a system fault.

**WARNING**

Do not travel carrying objects in your lap, in front of your chest or between your lips (pipe, pencils, etc.): they could cause severe injury if the airbag is deployed.

**WARNING**

When the key is turned to MAR warning light  (with passenger front airbag activated) will blink for a few seconds to remind you that the airbag will be deployed in the event of a collision after which it should go out.

**WARNING**

Do not wash the seats with pressurised water or steam (by hand or in automatic seat washing stations).

**WARNING**

The airbag deployment threshold is higher than that of the pretensioners. For collisions in the range between the two thresholds, it is normal for only the pretensioners to be activated.

**WARNING**

Do not attach rigid objects to the coat hooks and support handles.

**WARNING**

An airbag is not a replacement for the seat belts but increases their efficiency. Furthermore, since front airbags are not deployed in low speed collisions, side collisions, rear-end shunts or roll-overs, the occupants are only protected by the seat belts which must be fastened at all times.

STARTING AND DRIVING

STARTING THE ENGINE	114
PARKING THE VEHICLE	116
USING THE MECHANICAL GEARBOX.....	117
CONTAINING RUNNING COSTS	118
TOWING TRAILERS	119
SNOW TYRES	122
SNOW CHAINS	123
CAR INACTIVITY	124

DASHBOARD
AND
CONTROLS

SAFETY

STARTING
AND DRIVING

WARNING
LIGHTS AND
MESSAGES

IN AN
EMERGENCY

MAINTENANCE
AND CARE

TECHNICAL
SPECIFICA-
TIONS

INDEX



STARTING THE ENGINE

The car is provided with an electronic engine lock device: refer to “The Lancia CODE system” paragraph in “Dashboard and controls” if you cannot start the engine. The engine may be noisier during the first seconds of operation, particularly after a long period of inactivity. This is characteristic of hydraulic tappets, the timing system chosen for petrol engine versions to reduce the number of servicing interventions and does effects neither functionality nor reliability.

STARTING PROCEDURE FOR PETROL VERSIONS

Proceed as follows:

- apply the handbrake;
- put the gear lever into neutral;
- press the clutch pedal all the way down without touching the accelerator;
- turn the ignition key to **AVV** and let it go the moment the engine starts.

If the engine does not start at the first attempt, return the ignition key to **STOP** before repeating the attempt to start the engine. If with the key at **MAR** the instrument panel warning light  stays on with warning light , turn the key back to **STOP** and then back to **MAR**; if the warning light stays on, try with the other keys provided.



It is advisable not to demand maximum performance from your car (e.g. excessive accelerations, long distances at top rpm, excessive intense braking, etc.) as soon as the engine is started.



*Do not leave the key in the ignition switch in the **MAR** position with the engine off to avoid unnecessary consumption of electricity which could drain the battery.*



WARNING



It is dangerous to run the engine in closed environments. The engine consumes oxygen and engine exhaust contains carbon dioxide, carbon oxide and other toxic gasses.



Contact a Lancia Dealership if you still cannot start the engine.

IMPORTANT Never leave the ignition key to **MAR** when the engine is off.

PROCEDURE FOR MULTIJET VERSIONS

Proceed as follows:

- apply the handbrake;
- put the gear lever into neutral;
- turn the ignition key to **MAR**; warning lights ,  and .

- ❑ will light up on the instrument panel; wait for warning lights  and  to go out. This will happen faster when the engine is warm;
- ❑ press the clutch pedal all the way down without touching the accelerator;
- ❑ turn the ignition key to **AVV** as soon as the warning light  turns off. Waiting too long will waste the work done by the glow plugs. Release the key as soon as the engine starts.

IMPORTANT With the engine cold, the accelerator must be entirely released when turning the ignition key to position **AVV**.

If the engine does not start at the first attempt, return the ignition key to **STOP** before repeating starting.

If, when the ignition key is at **MAR**, the instrument panel warning light  remains lit, turn the key to **STOP** and then back to **MAR**; if the warning lights remain on, try with the other keys provided with the car.

Contact a Lancia Dealership if you still cannot start the engine.

IMPORTANT Never leave the ignition key to **MAR** when the engine is off.



Warning light  will blink for 60 seconds after starting or during prolonged cranking to indicate a fault to the glow plug heating system. Use the car normally if the engine starts and go to a Lancia Dealership as soon as possible.

HOW TO WARM UP THE ENGINE AFTER IT HAS JUST STARTED (petrol and Multijet engines)

Proceed as follows:

- ❑ drive off slowly, letting the engine turn at medium speed. Accelerate smoothly;
- ❑ do not demand maximum performance for the first few kilometres. Wait until the engine coolant gauge starts moving.

STOPPING THE ENGINE

Turn the ignition to **STOP** while the engine is idling.

IMPORTANT After a taxing drive, you should allow the engine to “catch its breath” before turning it off by letting it idle to allow the temperature in the engine compartment to fall.



Never jump start the engine by pushing, towing or driving downhill. This could cause a flow of fuel into the catalytic converter and damage it beyond repair.



A quick burst on the accelerator before turning off the engine serves absolutely no practical purpose, it wastes fuel and is damaging especially to turbocharged engines.

PARKING THE VEHICLE

Proceed as follows:

- Stop the engine and engage the handbrake;
- Engage a gear (on a slope, engage first gear if the vehicle is faced uphill or reverse if it is faced downhill) and leave the wheels steered.

If the car is parked on a steep slope, it is further advisable to block the wheels with a wedge or stone. Avoid parking for a long time with one wheel on the pavement or steered against the curb. Do not leave the key in the ignition switch at **MAR** to prevent draining the battery. Always remove the key when you leave the car.

HANDBRAKE

The handbrake lever is located between the two front seats.

Pull the lever upwards to operate the handbrake.

Four or five notches are normally sufficient to lock the car on flat terrain, while nine or ten may be necessary on a steep slope with the car loaded.

IMPORTANT If this is not the case, contact Lancia Dealership to have the handbrake adjusted.

When the handbrake lever is pulled up and the ignition key is at **MAR**, the instrument panel warning light (Ⓢ) will turn on.

Proceed as follows to release the handbrake:

- slightly lift the handbrake and press release button **A**-fig. 1;
- hold the button **A** pressed and lower the lever; the warning light (Ⓢ) on the instrument panel will go out.

Press the brake pedal when carrying out this operation to prevent the car from moving accidentally.

IMPORTANT if the handbrake lever tends to reach end of stroke (groove on the central tunnel), go to a Lancia dealership to have the handbrake adjusted correctly.

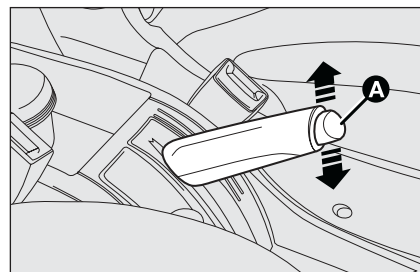

fig. 1



Never leave children unattended in the car. Always remove the ignition key when leaving the car and take it out with you.

USING THE MECHANICAL GEARBOX

To engage the gears, press the clutch pedal fully and shift the gear lever into one of the required positions (the diagram is shown on the knob).

IMPORTANT Reverse may only be engaged when the car is at a standstill. With the engine running, wait for at least 2 seconds with the clutch pedal fully pressed before engaging reverse to prevent damage to the gears and grating.

To engage 6th gear (for versions/markets, where provided), operate the lever by pressing it towards the right in order to avoid engaging 4th gear by mistake. The action is similar for shifting from 6th gear to 5th gear.

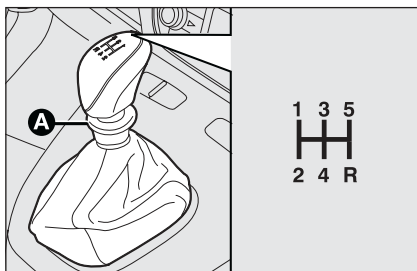

fig. 2

L0D0150m

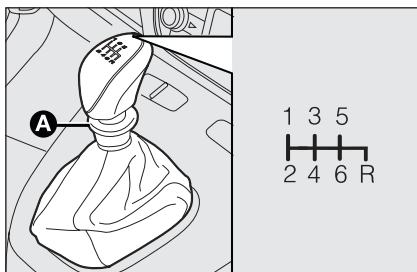

fig. 3

L0D0360m

To engage reverse **R** from the neutral position, lift the sliding ring **A**-fig. 2-3 under the knob and at the same time move the lever rightwards and then back (petrol versions only). For Multijet versions, simply move the lever rightwards and then back.



WARNING

Press the clutch pedal fully to change gears correctly. For this reason, there must be no obstacles on the floor under the pedals: ensure that rubber mats (if any) are correctly positioned, not interfering with the pedals.



Do not drive with your hand resting on the gear lever, because this pressure, even if light, over time can wear out the gearbox inner components.

CONTAINING RUNNING COSTS

Here are some suggestions which may help you to keep the running costs of your vehicle down and lower the amount of toxic emissions released into the atmosphere.

GENERAL CONSIDERATIONS

Car maintenance

Have checks and adjustments carried out in accordance with the “Service schedule”.

Tyres

Check tyre pressure regularly at least once every four weeks: excessively low pressure will increase consumption because rolling resistance will be higher.

Unnecessary loads

Do not travel with an overloaded boot. The weight of the car (especially when driving in town) and its trim greatly affects consumption and stability.

Roof rack/ski rack

Remove the roof rack or the ski rack from the roof after use. These accessories decrease aerodynamic penetration of the car and have a negative effect on consumption. It is better to use a trailer to transport particularly bulky objects.

Electric devices

Use electric devices only for the amount of time needed. Rear heated window, additional headlights, wind-screen wipers and heater fan need a considerable amount of energy, therefore increasing the requirement of current increases fuel consumption (up to +25% in the urban cycle).

Climate control

The climate control system requires higher fuel consumption (up to +20% in average): use the air vents when the external temperature allows to.

Spoilers

The use of non-certified aerodynamic items may adversely affect air drag and fuel consumption levels.

DRIVING STYLE

Starting

Do not warm the engine up with the car standing: the engine warms up very slowly in these conditions, increasing consumption and emissions. It is advisable to start off immediately and slowly keeping the engine speed down: the engine will warm up much faster this way.

Unnecessary actions

Avoid revving up when starting at traffic lights or before stopping the engine. The latter action, like doubling the clutch, is unnecessary and causes increase of consumption and pollution.

Gear selection

Use a higher gear as soon as traffic and road conditions allow. Using a low gear for faster acceleration will increase consumption.

In the same way improper use of a high gear increases consumption, emissions and engine wear.

Top speed

Fuel consumption considerably increases as speed increases. Keep your speed as even as possible, avoiding unnecessary braking and acceleration which cause excessive fuel consumption and increase emissions.

Acceleration

Sudden acceleration has a very negative effect on consumptions and emissions: accelerate gradually and do not go over the maximum torque ratio.

CONDITIONS OF USE

Cold starting

Short distances and frequent cold start-ups will prevent the engine from reaching optimal running temperature. Consequently, both consumption (from +15 to +30% on urban cycle) and emissions will increase.

Traffic and road conditions

Rather high consumption is caused by heavy traffic, for instance when travelling in a queue with frequent use of low gears or in cities with many traffic lights. Mountain and rough roads also have a negative effect on consumption.

Traffic hold-ups

During prolonged hold-ups (level crossings) the engine should be switched off.

TOWING TRAILERS

IMPORTANT NOTES

The car must be provided with a type-approved tow hitch and adequate electric system to tow caravans or trailers. Installation must be performed by specialised personnel who will issue the required papers for travelling on roads.

Install any specific and/or additional rearview mirrors as specified by the Highway Code.

Remember that when towing a trailer, steep hills are harder to climb, the braking spaces increase and overtaking takes longer depending on the overall weight.

Engage a low gear when driving downhill, rather than constantly using the brake.

DASHBOARD
AND
CONTROLS

SAFETY

STARTING
AND DRIVING

WARNING
LIGHTS AND
MESSAGES

IN AN
EMERGENCY

MAINTENANCE
AND CARE

TECHNICAL
SPECIFICA-
TIONS

INDEX

The weight of the trailer on the car's tow hitch will reduce the loading capacity of the car by the same amount. Consider the weight of the car at full load, including accessories and luggage to make sure you do not exceed the maximum towable weight (shown on the log book).

Respect the speed limits specific for each country for vehicles towing trailers. In all cases, the top speed must not exceed 100 km/h.



WARNING

The ABS with which the car may be equipped will not control the braking system of the trailer. Particular caution is required on slippery roads.



WARNING

Never modify the braking system of the car to control the trailer brake. The trailer braking system must be fully independent from the hydraulic system of the car.

INSTALLING THE TOW HOOK

The towing device should be fastened to the body by specialised personnel according to any additional and/or integrative information supplied by the Manufacturer of the device.

The towing device must meet current regulations with reference to 94/20/EC Directive and subsequent amendments.

For any version the towing device used must match the towable weight of the car on which it is to be installed.

For the electric connection a unified connector should be used which is generally placed on a special bracket normally fastened to the towing device, and a special ECU for external trailer light control shall be installed on the car.

For the electric connection, 7 or 13 pin 12VDC connection is to be used (CUNA/UNI and ISO/DIN Standards). Follow the instructions provided by the car manufacturer and/or the tow hitch manufacturer.

An electric brake should be supplied directly by the battery through a cable with a cross section of no less than 2.5 mm².

IMPORTANT Electric brake or other device shall be used with running engine.

In addition to the electric branches, the car's electric system can only be connected to the supply cable for an electric brake and to the cable for an internal light, though not above 15W.

For connections use the preset control unit with battery cable no less than 2.5 mm².

ASSEMBLY DIAGRAM fig. 4

The tow hook structure must be fastened in the points shown by the symbol  using a total of 4 M8 screws, 2 M10 screws and 2 M12 screws.

The hook should be fastened to the body avoiding any type of drilling and trimming of the rear bumpers that remains visible when the hook is removed.

IMPORTANT It is compulsory to fasten a label (plainly visible) of suitable size and material with the following wording:

MAX LOAD ON BALL 60 kg



WARNING

After fitting, screw holes shall be sealed to prevent exhaust gas inlet.

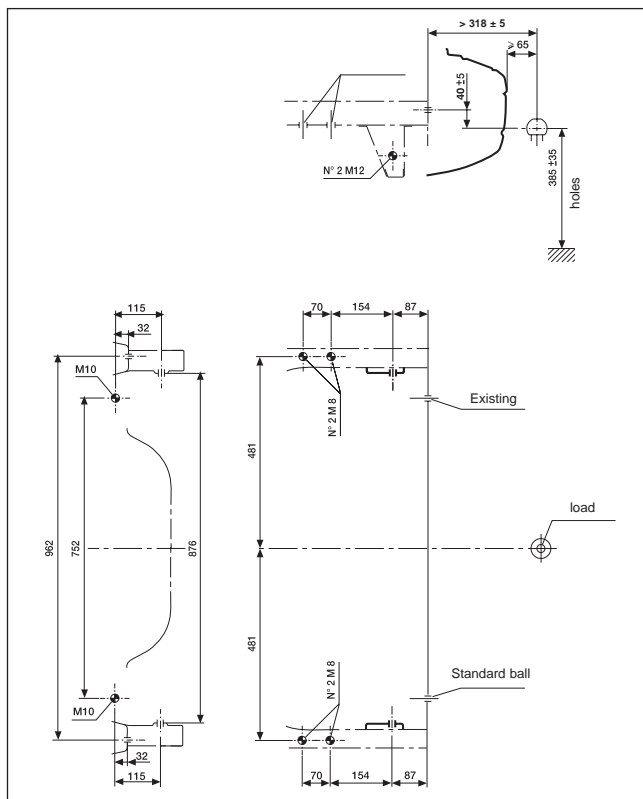

fig. 4

L0D0256m

SNOW TYRES

Use snow tyres of the same size as the normal tyres provided with the car.

Lancia Dealership will be happy to provide advice concerning the most suitable type of tyre for the customer's requirements.

For the type of tyre to be used, inflation pressures and the specifications of snow tyres, follow the instructions given in paragraph "Wheels" in section "Technical specifications".

The performance of these tyres is considerably reduced when the tread depth is less than 4 mm. Replace them in this case.

Due to their specific features, the performance of snow tyres is much lower than that of normal types in normal conditions or long motorway stretches. Limit performance according to the use for which they were approved.

IMPORTANT When snow tyres are used with a max speed index below the one that can be reached by the car (increased by 5%), place a notice in the passenger's compartment, plainly in the driver's view which states the max permissible speed of the snow tyres (as per EC Directive).

All four tyres should be the same (brand and track) to ensure greater safety when driving and braking and better driveability.

Remember that it is inappropriate to change the direction of rotation of tyres.



WARNING

The top speed of a "T" type snow tyre is 190 km/h. Respect the highway code in all cases.

SNOW CHAINS

Use of snow chains should be in compliance with local regulations.

The snow chains may be applied only onto the front wheel tyres (drive wheels). Use of Lineaccessori Lancia snow chains is recommended.

Check the tension of the chains after the first few metres have been driven.

IMPORTANT Snow chains cannot be fitted on the space saver wheel. In case of puncture to a front tyre, replace a rear wheel using the space saver spare and fit the normal size wheel on the front axle. In this way, you can fit snow chains on the two front wheels.



WARNING

Chains cannot be fitted on 205/50 R16 87V tyres.

Tyres suitable for fitting

185/65 R14 86T

195/60 R15 88T

Chain type snow chains to be used

Normal size snow chains with maximum protrusion beyond tyre profile equal to 12 mm.



The tyres which are suitable for fitting snow chains and the type of chain which can be used are shown in the table above. Follow indications carefully.



Keep your speed down when snow chains are fitted. Do not exceed 50 km/h. Avoid potholes, steps and pavements and also avoid driving long distances on roads not covered with snow in order to prevent damaging the car and the roadbed.

CAR INACTIVITY

If the car is to be left inactive for longer than a month, the following precautions should be noted:

- park the car in covered, dry and if possible well-ventilated premises;
- engage a gear;
- check that the handbrake is not engaged;
- disconnect the negative battery terminal and check battery charge. Repeat this check once every three months during storage. Recharge the battery if the optical indicator shows a dark colour without the central green area;

- clean and protect the painted parts using protective wax;
 - clean and protect the shiny metal parts using special compounds readily available;
 - sprinkle talcum powder on the rubber windscreen and rear window wiper blades and lift them off the glass;
 - slightly open the windows;
 - cover the car with a fabric or perforated plastic tarp. Do not use compact plastic sheets which do not allow humidity to evaporate from the surface of the car.
- inflate tyres to a pressure of +0,5 bar above the normal specified pressure and check it at intervals;
 - if you don't disconnect the battery from the electric system, check its charge every month and recharge it if the optical indicator shows a dark colour without the central green area;
 - do not drain the engine cooling system.

WARNING LIGHTS AND MESSAGES

GENERAL WARNINGS	126	GLOW PLUG FAILURE	131
LOW BRAKE FLUID LEVEL	126	WATER IN DIESEL FUEL FILTER	131
HANDBRAKE APPLIED.....	126	LANCIA CODE PROTECTION SYSTEM FAILURE	132
AIRBAG FAILURE	126	REAR FOG LIGHTS	132
HOT ENGINE COOLANT	127	GENERIC INDICATION	132
LOW BATTERY CHARGE	127	WORN BRAKE PADS	133
LOW ENGINE OIL PRESSURE	128	OBSTRUCTED PARTICULATE TRAP	133
EXHAUSTED OIL	128	SIDE, TAILLIGHTS AND DIPPED BEAM HEADLIGHTS	133
“DUALDRIVE” ELECTRIC POWER STEERING SYSTEM	129	FOLLOW ME HOME	133
DOOR OPEN	129	FOG LIGHTS	133
SEAT BELT REMINDER.....	129	LEFT-HAND DIRECTION INDICATOR	134
EBD FAILURE	129	RIGHT-HAND DIRECTION INDICATOR	134
INJECTION SYSTEM FAILURE	129	“DUALDRIVE” ELECTRIC POWER STEERING SYSTEM ON	134
EOBD ENGINE CONTROL SYSTEM FAILURE	129	CRUISE CONTROL	134
FRONT PASSENGER AIRBAG DEACTIVATED..	130	MAIN BEAM HEADLIGHTS	134
ABS FAILURE	131	POSSIBLE ICE ON ROAD	134
FUEL RESERVE	131	LIMITED RANGE	134
GLOW PLUGS	131		

GENERAL WARNINGS

Warning lights are associated to a specific message and/or buzzer when applicable. Indications are **brief and precautionary** and as such must not be considered as exhaustive and/or alternative to the information contained in the Owner's Handbook, which you are recommended to read carefully in all cases. Refer to the information in this chapter **in the event of a failure indication**.

IMPORTANT Failure indications on the display fall into either of two categories: **serious** faults and **less serious** faults.

A warning cycle will be repeated in case of **severe** failures until the cause of the problem is eliminated.

A shorter warning cycle will be run in case of **less severe** faults.

Press **MODE** to stop the warning cycle in both cases. The warning light on the instrument panel will stay on until the cause of the fault is eliminated.



LOW BRAKE FLUID

(red)

HANDBRAKE ON (red)

When the ignition key is moved to **MAR**, the warning light turns on and should go off after a few seconds.

Low brake fluid level

The warning light comes on when the level of the brake fluid in the reservoir falls below the minimum level due to possible leaks in the circuit.

The display will show the dedicated message.



WARNING

If the warning light (ⓘ) turns on when travelling (with the message on the display) stop the car immediately and contact Lancia Dealership.

Handbrake on

The warning light turns on when the handbrake is on.

On certain versions, if the car is moving the buzzer will also sound.

IMPORTANT If the warning light turns on when travelling, check that the handbrake is not engaged.



AIRBAG FAILURE (red)

When the ignition key is moved to **MAR**, the warning light turns on and should go off after a few seconds.

The warning light stays on steady if there is a failure in the airbag system.

The display will show the dedicated message.





WARNING

*If when turning the key to **MAR** the warning light  does not turn on or if it stays on when travelling (together with the message on the multifunctional display, where provided) there could be a failure in safety systems; in this event air bags or pretensioners may not be deployed in case of impact or, in a minor number of cases, they be deployed accidentally. Contact Lancia Dealership immediately to have the system checked.*



WARNING

Failure of warning light  is indicated by warning light  which will blink for longer than the normal 4 seconds indicating that the front passenger airbag is off. The airbag system will automatically deactivate the passenger airbag (front and side, for versions/markets, where provided). In this case, warning light  may not indicate fault to the system. Contact Lancia Dealership immediately to have the system checked.



HOT ENGINE COOLANT (red)

When the ignition key is moved to **MAR**, the warning light turns on and should go off after a few seconds.

The warning light turns on when the engine is overheated.

If the warning light comes on, proceed as follows:

- ❑ **during normal travel:** stop the car, stop the engine and check that the water level in the vessel is not under the **MIN** line. In this case, wait for a few minutes for the engine to cool down when slowly and carefully open the cap, top-up with coolant and check that the level is between the **MIN** and **MAX** references on the vessel itself. Also check for leakages. Go to a Lancia Dealership if the warning should come on when the engine is started again.

- ❑ **In the case of demanding use** (e.g. towing trailers uphill or car at full load): slow down and stop the car if the warning light stays on. Stand for 2 or 3 minutes with the engine running and slightly accelerated to promote a better circulation of coolant. Then stop the engine. Check correct liquid level as described above.

IMPORTANT After taxing operation, it is advisable to keep the engine on and slightly accelerated for a few minutes before switching it off.

The display will show the dedicated message.



LOW BATTERY CHARGE (red)

When the ignition key is moved to **MAR**, the warning light turns on and should go out as soon as the engine is started (with the engine running at idle speed a brief delay in going out is allowed). Go to a Lancia Dealership immediately if the warning light stays on.



LIGHT STAYS ON: LOW ENGINE OIL PRESSURE (red)

FLASHING LIGHT: EXHAUSTED ENGINE OIL (only Multijet versions with DPF - red)

When the ignition key is turned to MAR (ON), the warning light switches on and should go out as soon as the engine is started.

1. Low engine oil pressure

The warning light turns on and stays on constantly (for versions/markets, where provided) along with the message on the display when the system detects that engine oil pressure is low.



WARNING

If the warning light  turns on when the vehicle is travelling (on certain versions together with the message on the display) stop the engine immediately and contact a Lancia Dealership.

2. Exhausted engine oil (only Multijet versions with DPF)

The warning light will flash and a specific message will appear on the display (for versions/markets, where provided). The warning light may flash in the following ways, depending on the version:

- for 1 minute every two hours;
- for 3 minute cycles with the warning light off for intervals of 5 seconds until oil is changed.

After the initial warning, each time the engine is started up, the warning light will continue to flash in the above mentioned modes, until the oil is changed. A specific message will appear on the display (for versions/markets, where provided) in addition to the warning light.

If the warning light flashes, this does not mean that the car is defective but simply informs the driver that it is now necessary to change the oil as a result of regular vehicle use.

Note that engine oil is exhausted faster under the following circumstances:

- use of the vehicle prevalently for city driving, requiring more frequent regeneration of DPF
- use of the vehicle for short drives, in which the engine does not have time to reach its regular operating temperature
- repeated interruption of the regeneration process, signalled by the DPF warning light coming on.



WARNING

Exhausted engine oil should be replaced as soon as possible after the warning light comes on, never more than 500 km after the warning light first comes on. Failure to change the oil within the first 500 km may result in severe damage to the engine and will result in forfeiture of the warranty. Remember that when the warning light flashes, it does not mean that the level of engine oil is low, so if the light flashes you must not top up.



“DUALDRIVE” ELECTRIC POWER STEERING SYSTEM (red)

This warning light comes on when the ignition key is turned to **MAR**, but it should go off after a few seconds.

The electric power steering system will not work when the warning light is on and considerably more effort is needed on the steering wheel. The car can still be steered: go to a Lancia Dealership.

The display will show the dedicated message.



DOOR OPEN (red)

On certain versions the warning light turns on when one or more doors or the tailgate are not properly closed.

The display will show a dedicated message.

A buzzer will sound when doors/tailgate are open and the car is moving.





SEAT BELTS REMINDER (red) (for versions/markets, where provided)

The warning light on the display will light up when the car is moving and the driver's seat belt is not correctly fastened. The warning light will blink and a buzzer will sound if the front seat belts are not correctly fastened. The buzzer of the SBR (Seat Belt Reminder) system may only be switched off by a Lancia Dealership. The system can be reactivated by means of the setup menu.



EBD FAILURE (red) (amber)

Warning lights  and  lit at the same time with the engine running indicates an EBD system failure or that the system is not available. Early locking of the rear wheels may occur in the event of violent braking causing the car to swerve. Drive very carefully to a Lancia Dealership to have the system inspected.

The display will show the dedicated message.



INJECTION SYSTEM FAILURE (Multijet versions - amber)

SYSTEM FAILURE EOBD ENGINE CONTROL (petrol versions - amber)

Injection system failure

When the ignition key is moved to **MAR**, the warning light turns on and should go out as soon as the engine is started.

If the warning light stays on or turns on when travelling, means a fault in the supply/ignition system which could cause high emissions at the exhaust, possible lack of performance, poor handling and high consumption levels.

The display will show a dedicated message.

In these conditions, you may continue travelling at moderate speed without demanding excessive effort from the engine. Go to a Lancia Dealership as soon as possible.

EOBD engine control system failure

In normal conditions, when the ignition key is moved to **MAR**, the warning light turns on and should go off after engine start-up. This indicates that the warning light is working correctly. If the warning light either stays on or comes on while travelling:

- *steady light*: a fault in the supply/ignition system which could cause high emissions at the exhaust, possible lack of performance, poor handling and high consumption levels.



The display will show the dedicated message.

In these conditions, you may continue travelling at moderate speed without demanding excessive effort from the engine. Prolonged use of the car with the warning light on may cause damage. Go to a Lancia Dealership as soon as possible. If warning light will go out after the fault goes away but it will be stored in the system.

- *blinking light*: indicates the possibility of damage to the catalyser (see “EOBD system” in section “Dashboard and controls”).

If the light flashes, release the accelerator pedal to lower the speed of the engine until the warning light stops flashing; continue the journey at moderate speed, trying to avoid driving conditions that may cause further flashing and contact Lancia Dealership as soon as possible.



Go to a Lancia Dealership as soon as possible if warning light  either does not light up when the key is turned to MAR to if while travelling the warning lights comes on either steady or blinking (along with a message on the multifunctional display, where provided). The operation of warning light  may be checked by the traffic police using specific devices. Follow the laws in force in the country where you are driving.





FRONT PASSENGER AIRBAG DEACTIVATED (amber)

Warning light  comes on when front passenger's airbag is deactivated.

With the front passenger's airbag on, when the ignition key is moved to **MAR**, the warning light  comes on steadily for about 4 seconds; then, it continues to flash for 4 seconds and finally goes off.



WARNING

Failure of the warning light  is indicated by warning light . The airbag system will automatically deactivate the passenger airbag (front and side, “”). Contact Lancia Dealership immediately to have the system checked.



ABS SYSTEM FAILURE (amber)

When the ignition key is moved to **MAR**, the warning light turns on and should go off after a few seconds.

The warning light will light up when the system is either not working or not available. In the case, the braking system will work as normal without the extra potentials offered by the ABS system. Drive carefully and go to a Lancia Dealership as soon as possible.

The display will show the dedicated message.



FUEL RESERVE (amber)

When the ignition key is moved to **MAR**, the warning light turns on and should go off after a few seconds.

The warning light turns on when about 6/7 litres fuel are left in the tank.

IMPORTANT The warning light will blink to indicate a system failure. Go to a Lancia Dealership to have the system checked.



GLOW PLUG WARMING (Multijet versions - amber)

GLOW PLUG FAILURE (Multijet versions -amber)

Glow plugs

The warning light will go on when the key is turned to **MAR**. It will go out as soon as the glow plugs have reached a predetermined temperature. Start the engine as soon as the warning light goes out.

IMPORTANT With hot ambient temperature, warning light stays on for very short time.

Glow plug warming failure

The warning light will blink in the event of a failure to the glow plug heating system. Go to a Lancia Dealership as soon as possible.

The display will show the dedicated message.



WATER IN DIESEL FUEL FILTER (Multijet versions - amber)

When the ignition key is moved to **MAR**, the warning light turns on and should go off after a few seconds.

The warning light  turns on when there is water in the diesel fuel filter.

The display will show the dedicated message.





The presence of water in the feeding circuit may cause severe damage to the injection system and irregular engine operation. If warning light  lights up (on some versions with the message on the display), go to a Lancia Dealership as soon as possible to have the system bled. Water may have been introduced in the tank if this appears immediately after refuelling: in this case, stop the engine immediately and contact a Lancia Dealership.



LANCIA CODE PROTECTION SYSTEM FAILURE (amber)

Turning the key to **MAR**, the warning light flashes once and then goes off.

If with the ignition key at **MAR**, the warning light stays on, this indicates a possible failure (see “Lancia Code system” in section “Dashboard and controls”).

IMPORTANT The turning on at the same time of the  and  warning lights indicates a failure of the Lancia CODE system.

If with the engine running the warning light  flashes, this means that the car is not protected by the engine immobilizer device (see “Lancia Code system” in section “Dashboard and controls”).

Contact Lancia Dealership to have all the key stored.



REAR FOG LIGHTS (amber)

The warning light comes on when the rear fog lights are on.



GENERIC INDICATION (amber)

The warning light turns on in the following circumstances.

Exterior lights failure

The warning light will come on (some versions only) when a fault to one of the following lights is detected:

- side/taillights
- brake lights (excluding third brake light)
- rear fog lights
- direction indicators
- number plate lights.

The fault may be caused by: one or more burnt lamps, a blow protection fuse or interruption of the electrical connection.

The display will show the dedicated message.

Obstructed particulate trap (for versions/markets, where provided)

The warning light turns on when the diesel particulate trap is clogged and the driving conditions do not enable to activate automatically the regeneration procedure.

To allow the regeneration procedure, keep the car running until the warning light turns off.

The display will show a dedicated message.

Engine oil pressure sensor failure

The warning light turns on when failure is detected in parking sensors. Go to a Lancia Dealership as soon as possible.

Rain/dusk sensor failure

The warning light comes on when a dusk/rain sensor failure is detected. Go to a Lancia Dealership as soon as possible.

The display will show a dedicated message.

Fuel cut-off switch tripped

The warning light comes on when the fuel cut-off switch trips.

The display will show a dedicated message.

Speed limit exceeded

The display will show the dedicated message when the car exceeds the set speed limit (see “Multifunctional Display” in section “Dashboard and controls”).



WORN BRAKE PADS (amber)

The warning light turns on if the front brake pads are worn; in this case have them changed as soon as possible.

The display will show the dedicated message.

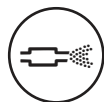

CLEANING DPF (PARTICULATE FILTER) IN PROGRESS (only Multijet versions with DPF - amber)

When the ignition key is turned to MAR (ON), the warning light switches on but it must switch off after a few seconds. The warning light comes on constantly to notify the driver that the DPF system needs to eliminate captured pollutants (particulate) by the regeneration process. The warning light does not come on during every

DPF regeneration, but only when driving conditions require notification of the driver. To switch the warning light off, the car must stay in motion until regeneration has been completed. The process normally takes about 15 minutes. The optimum conditions to end the process are achieved by keeping the car in motion up to 60km/h with an engine speed higher than 2,000 rpm. This light coming on is not a car defect and therefore the car does not need to go to the workshop. A specific message will appear on the display when the warning light comes on (for versions/markets, where provided).



WARNING

Always drive at a speed appropriate to the traffic conditions, the weather and speed limits. The engine may be turned off while the DPF light is on; however, repeated interruption of the regeneration process may result in premature exhaustion of engine oil. For this reason it is always advisable to wait for the light to go off before turning off the engine, following the instructions appearing above. It is not advisable to complete DPF regeneration with the vehicle stationary



SIDE/TAIL LIGHTS AND LOW BEAMS (green)

FOLLOW ME HOME (green)

Side/tail lights and low beams

The warning light comes on when side/tail lights or low beams are turned on.

Follow me home

The warning light will turn when this device is active (see “Follow me home” in section “Dashboard and controls”).

The display will show the dedicated message.



FOG LIGHTS (green)

The warning light comes on when the fog lights are on.



LEFT-HAND DIRECTION INDICATOR

(green - blinking)

The warning light turns on when the direction indicator control lever is moved downwards or, together with the right indicator, when the hazard warning light button is pressed.



RIGHT-HAND DIRECTION INDICATOR

(green - blinking)

The warning light turns on when the direction indicator control lever is moved upwards or, together with the left indicator, when the hazard warning light button is pressed.



“DUALDRIVE” ELECTRIC POWER STEERING SYSTEM ON (symbol on display)

The message CITY lights up on the display when the “Dualdrive” electric power steering system is turned on by pressing the corresponding control button. Press the button again to turn the CITY indication off.



CRUISE CONTROL (green)

(for versions/markets,
where provided)

When the ignition key is moved to **MAR**, the warning light turns on and should go off after a few seconds.

The warning light is lit up on the display by rotating the Cruise Control selector wheel to **ON**.

The display will show the dedicated message.



MAIN BEAM HEADLIGHTS (blue)

The warning light turns on when the main beams are turned on.

POSSIBLE ICE ON ROAD

When the external temperature reaches or drops under 3 °C, to indicate the possible presence of ice on the road. Symbol ❄ will appear on the display, with a warning message and the temperature indication will start blinking.

LIMITED RANGE

A message will appear on the display to inform the driver that the remaining range is less than 50 kilometres (30 miles) or that there are less than 4 litres of fuel in the tank.

IN AN EMERGENCY

In an emergency we recommend that you call the toll-free number found on the Warranty Booklet. You will go to our web site at www.Lancia.com to find the Lancia Dealership nearest to you.

OPENING/CLOSING THE DOORS	136
STARTING THE ENGINE	136
FIX & GO Automatic QUICK TYRE REPAIR KIT	138
REPLACING A WHEEL	142
WHEN NEEDING TO CHANGE A BULB	147
REPLACING EXTERIOR BULBS	150
REPLACING AN INTERIOR BULB	155
REPLACING FUSES	156
IF THE BATTERY IS FLAT	161
LIFTING THE CAR	161
TOWING THE CAR	162

DASHBOARD
AND
CONTROLS

SAFETY

STARTING
AND DRIVING

WARNING
LIGHTS AND
MESSAGES

IN AN
EMERGENCY

MAINTENANCE
AND CARE

TECHNICAL
SPECIFICA-
TIONS

INDEX

OPENING/CLOSING THE DOORS

Emergency device for opening the doors from the outside

The doors are provided with a device for locking all the door using the lock in case of a power fault.

Proceed as follows to lock the doors:

- insert the ignition key in lock **B**-fig. 1
- turn the device to position **1** and close the door.

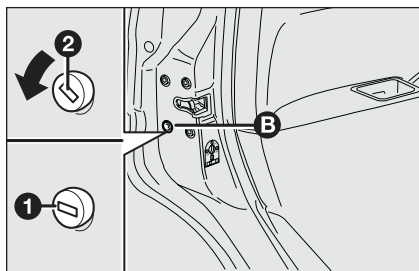

fig. 1

L0D0247m

To reopen the doors:

- insert the key in the lock on driver's side and turn it anticlockwise
- open the driver's door
- operate the door levers from the inside of the vehicle for the remaining doors.

STARTING THE ENGINE

JUMP STARTING

If the battery is flat, the engine may be started using an auxiliary battery with the same capacity or a little higher than the flat one.

Proceed as follows to start the engine:

- connect the positive terminals (+ sign near terminal) of both batteries using a lead;
- With a second lead, connect the negative terminal (-) of the auxiliary battery to an earthing point ↓ on the engine or the gearbox of the car to be started;
- start the engine;
- when the engine has been started, remove the leads reversing the order above. If engine fails to start again do not attempt any further and call a Lancia Dealership.

If after a few attempts the engine does not start, do not insist but contact the nearest Lancia Dealership.

IMPORTANT Never connect the negative terminals of the two batteries directly: sparks could ignite explosive gas released from the battery. If the auxiliary battery is installed on another car, prevent accidental contact between metallic parts of the two cars.

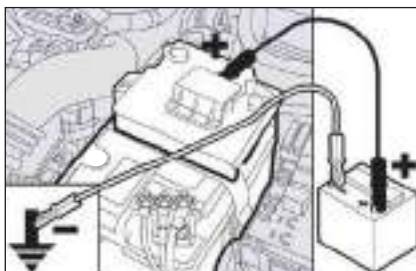

fig. 2

L0D0396m



Never use a rapid battery charger to jump start the engine: this could damage the electronic systems and the engine ignition and injection control units.



WARNING

This procedure must be performed by expert personnel because incorrect actions may cause electrical discharge of considerable intensity. Furthermore, battery fluid is poisonous and corrosive: avoid contact with your skin and eyes. Keep naked flames away from the battery. No smoking. Do not cause sparks.

DASHBOARD
AND
CONTROLS

SAFETY

STARTING
AND DRIVING

WARNING
LIGHTS AND
MESSAGES

IN AN
EMERGENCY

MAINTENANCE
AND CARE

TECHNICAL
SPECIFICA-
TIONS

INDEX

BUMP STARTING

Never bump start the engine by pushing, towing or driving downhill. This could cause a flow of fuel into the catalytic converter and damage it beyond repair.

IMPORTANT Remember that the brake servo and the electric power steering system are not activated until the engine is started, a greater effort will therefore be required to press the brake pedal or turn the steering wheel.



WARNING

Indicate that the car is standing according to the laws in force: emergency lights, refracting warning triangle, etc. Passengers should leave the car, particularly if it is very loaded, and wait for the wheel to be changed away from on-coming traffic. Arrange wedges or other suitable material under the wheels to block the car on slopes or rough roads.

FIX & GO Automatic QUICK TYRE REPAIR KIT

(for versions/markets, where provided)

The automatic Fix & Go quick tyre repair kit **fig. 3** is placed in the boot.

The kit includes:

- bottle **A** containing sealer and fitted with:
 - filling pipe **B**;
 - an adhesive label **C** with the message “max. 80 km/h” to be apply in a position clearly visible by the driver (on the dashboard) after repairing the tyre;
- instruction brochure (see **fig. 4**), to be used for prompt and proper use of the quick repair kit and to be then handed to the personnel charged with handling the treated tyre;

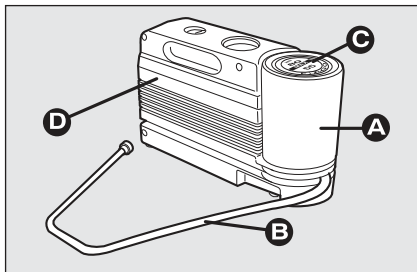

fig. 3

L0D0361m



fig. 4

L0D0362m

- compressor **D** including gauge and connections;
- a pair of protection gloves located in the side space of the compressor;
- adapters for inflating different elements.

The quick repair kit container in the boot under the mat also contains the screwdriver and tow rings.



WARNING

Give the instruction booklet to the tyre repair workshop personnel.

IMPORTANT Do not use the quick repair kit if the tyre was damaged by running on a flat.

IMPORTANT INFORMATION:

The sealing fluid of the quick tyre repair kit is effective with external temperatures between 20 °C –and +50 °C.

The sealing fluid will expire.



Replace the cylinder containing the sealant after the expiration date. Dispose of the cylinder and the sealant liquid properly. Dispose according to the national and local laws in force.



In the event of a puncture caused by foreign bodies, the kit may be used to repair tyres showing damages on the track or shoulder up to max 4 mm diameter.



WARNING

The kit cannot be used to repair damage to the tyre sidewall. Do not use the quick repair kit if the tyre was damaged by running on a flat.

The damage cannot be repaired with the kit if the wheel rim is damaged (deformation of the channel causing leakage of air). Do not remove the foreign body (screw or nail) from the tyre.

Do not operate the compressor for longer than 20 consecutive minutes. Risk of overheating. The quick repair kit is not suitable for definitive repairs. The tyres may only be repaired temporarily.

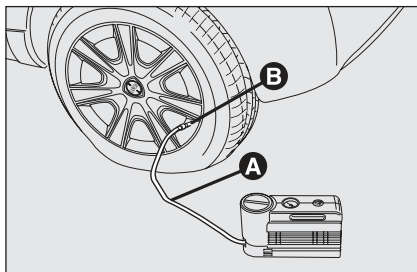

fig. 5

L0D0484m

INFLATION PROCEDURE

- Ensure that the handbrake is up. Undo the tyre valve cap, extract the inflation tube **A**-fig. 5 and tighten the ring nut **B** on the tyre valve;



WARNING

Put on the protection gloves provided together with quick tyre repair kit.



WARNING

The cylinder contains ethyl glycol. Contains latex: may cause an allergic reaction. Harmful if swallowed. Irritant for the eye. May cause sensitization by inhalation or contact. Avoid contact with your eyes, skin and clothes. In the event of contact, wash immediately with plenty of water. Do not induce vomit if swallowed. Rinse your mouth and drink plenty of water. Call a doctor immediately. Keep away from children. The product must not be used by asthmatics. Do not breath in the vapours during insertion and suction. Call a doctor immediately if allergic reactions are noted. Store the cylinder in the specific compartment, away from sources of heat.

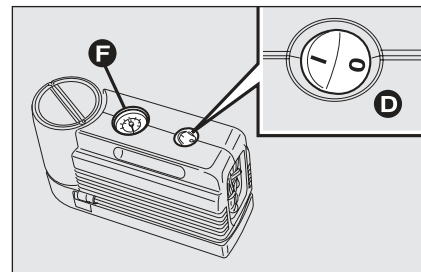

fig. 6

L0D0364m

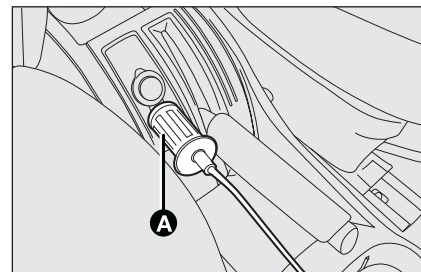

fig. 7

L0D0177m

- make sure that the switch **D**-fig. 6 of the compressor is in position **0** (off), start the engine, insert plug **A**-fig. 7 into the cigar lighter (or 12V socket) and operate the compressor by taking the switch **D** to position **I** (on). Inflate the tyre to the pressure specified in the "Inflation pressure" paragraph, "Technical Specifications" chapter.

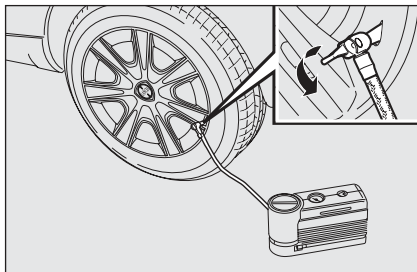

fig. 8

L0D0485m

For a more accurate reading, check pressure gauge **F-fig. 6** with the compressor off;

- if after 5 minutes it is still impossible to reach at least 1.5 bar, disengage compressor from valve and current outlet, then move the car forth for approx. ten metres in order to distribute the sealing fluid inside the tyre evenly, then repeat the inflation operation;
- If after this operation it is still impossible after 5 minutes to reach at least 1.8 bar, do not start driving since the tyre is excessively damaged and the quick tyre repair kit cannot guarantee suitable sealing, contact Lancia Dealership.



WARNING

Apply the adhesive label in a position clearly visible by the driver as a reminder that the tyre has been treated with the quick repair kit. Drive carefully, particularly on bends. Do not exceed 80 km/h. Do not accelerate or brake suddenly.



WARNING

Stop if the pressure has dropped to less than 1.8 bars: the automatic Fix & Go quick repair kit cannot work properly because the tyre is excessively damaged. Go to a Lancia Dealership.

- if reaching the tyre pressure specified in paragraph “Inflation pressure” in section “Technical Specifications”, start driving immediately;
- after driving for about 10 minutes stop and check again the tyre pressure; pull up the handbrake;
- if at least 1.8 bar pressure is read, restore proper pressure (with engine running and handbrake on) and restart;
- drive with the utmost care to the nearest Lancia Dealership.

FOR CHECKING AND RESTORING PRESSURE ONLY

The compressor may also be used for restoring pressure only. Release the quick coupling and connect directly to the tyre valve; in this way, the cylinder will not be connected to the compressor and no sealant will be injected.

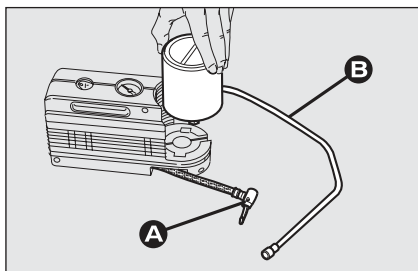

fig. 9

L0D0368m

CANISTER REPLACEMENT PROCEDURE

To replace the canister, proceed as follows:

- disconnect connection **A**-fig. 9;
- turn anticlockwise the canister to replace and raise it;
- fit the new canister and turn it clockwise;
- connect **A** to the canister and insert the transparent tube **B** in the specific compartment.



WARNING

Remember to inform the workshop that the tyre has been treated with a quick repair kit. Give the instruction booklet to the tyre repair workshop personnel.

REPLACING A WHEEL

GENERAL INSTRUCTIONS

Wheel changing and correct use of the jack and spare wheel call for some precautions as listed below.

IMPORTANT Refer to the instructions in the previous chapter if the car is equipped with “Fix&Go (quick tyre repair kit)”.



WARNING

The spare wheel is specific for your car. Do not use it on cars of different models. Do not use spare wheels of different models on your car. The space saver spare wheel must only be used in case of emergency. Use only for as long as strictly necessary and drive at a speed slower than 80 km/h. An orange label is affixed on the spare wheel summarising instructions and limitations for use. Never remove or cover the label. Never apply a wheel cup on a space saver spare. The following information is provided in four languages on the label: Warning! Suitable for temporary use only! 80 km/h max! Replace with a standard wheel as soon as possible. Do not cover this label.



WARNING

The driving features of the car may change when a space saver spare wheel is fitted. Avoid sudden acceleration and braking, sudden steering and fast cornering. The total life of a space saver spare wheel is approximately 3000 km, after which it must be replaced by another wheel of the same type. Never install a traditional tyre on a space saver spare wheel rim. Repair and refit the standard wheel as soon as possible. Only one space saver spare can be used at a time. Do not apply grease to the bolt threading before assembly: the bolts could come loose unexpectedly.



WARNING

The jack may only be used to replace wheels on the car which it equips or other cars of the same model. Never use the jack for other purposes, such as lifting other car models. Never use the jack to carry out repairs under the car. Incorrect positioning of the jack may cause the car to fall. Do not use the jack for loads higher than those shown on the label. Snow chains cannot be fitted on a space saver spare wheel. Therefore, if a front wheel (drive wheel) is punctured and you need to use snow chains, swap with a rear wheel. In this way, you will have two normal wheels on the front on which you can fit snow chains and solve the emergency.



WARNING

Incorrect wheel cup assembly may cause it to come off when the car is travelling. Never tamper with the inflation valve. Never introduce tools of any kind between rim and tyre. Check tyre and space saver spare wheel pressure regularly referring to the values shown in the “Technical Specifications” chapter.

DASHBOARD
AND
CONTROLS

SAFETY

STARTING
AND DRIVING

WARNING
LIGHTS AND
MESSAGES

IN AN
EMERGENCY

MAINTENANCE
AND CARE

TECHNICAL
SPECIFICA-
TIONS

INDEX

Important notes:

- the jack cannot be repaired: replace with an original spare part if damaged;
- no tool other than its cranking device may be fitted on the jack.

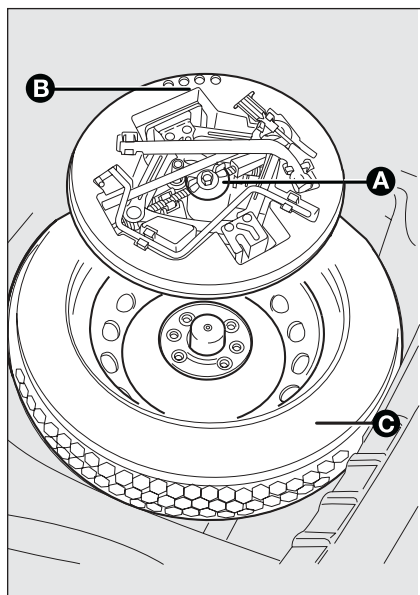

fig. 10

L0D0161m

To change a wheel proceed as follows:

- stop the car in a position so that it is not a danger for on-coming traffic and where you can replace the wheel safely. The ground must be flat and compact;
- turn the engine off and pull up the handbrake.
- engage first gear or reverse;
- lift the boot mat;
- loosen the fastening device **A-fig. 10**;
- take out the tool container **B** and take it near to the wheel to be changed;
- take the space saver spare wheel **C**;

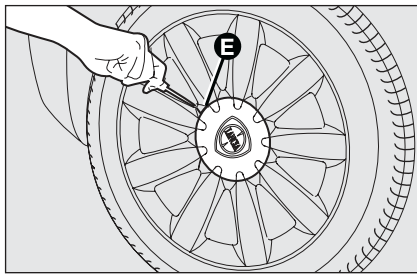

fig. 11

L0D0397m

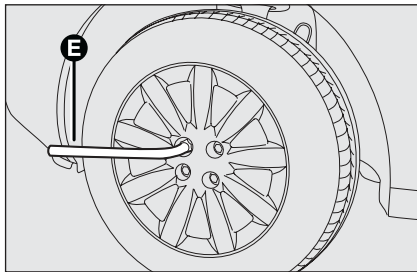

fig. 12

L0D0163m

- ❑ for cars fitting alloy rims, remove the hub cap using the screwdriver provided levering in groove **E**-**fig. 11**, as shown in the figure;
- ❑ loosen the bolts of the wheel to be replaced by about one turn with the wrench provided **E**-**fig. 12**; if the car is fitted with alloy rims, shake the car to facilitate removing the rim from the wheel hub;

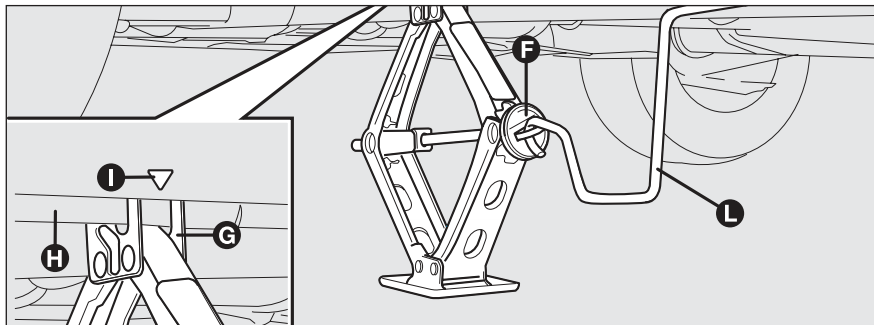

fig. 13

L0D0164m

- ❑ operate the device **F**- **fig. 13** to expand the jack, until the groove **G** on the upper part of the jack is correctly inserted on the lower edge **H** of the body at indication **I** (at approximately 60 cm from the front wheel centre or 80 cm from the rear wheel centre);
- ❑ warn anybody nearby that the car is about to be lifted. They must stay clear and not touch the car until it is back on the ground;
- ❑ fit the handle **L**-**fig. 13** to operate the jack and lift the car until the wheel to be changed is several centimetres off the ground;
- ❑ for versions with wheel cap, remove the wheel cap after loosening the three fastening bolts and finally loosen the fourth bolt and extract the wheel;
- ❑ for versions with snap fitted wheel cup, remove the cup being careful not to damage it;
- ❑ make sure the contact surfaces between space saver spare wheel and hub are clean so that the fastening bolts will not come loose;

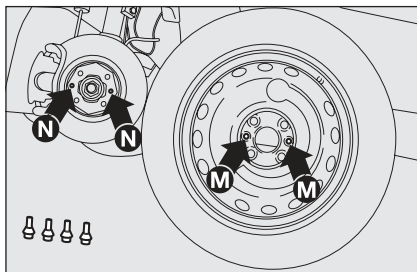

fig. 14

L0D0165m

- fit the space saver spare wheel making the holes **M**-fig. 14 coincide with the corresponding centering pins **N**;
- using the wrench provided, tighten the fastening bolts;
- turn the jack handle to lower the car and remove the jack;
- use the wrench provided to fasten the bolts completely in a criss-cross fashion as shown in figure.

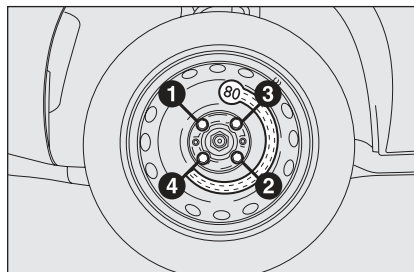

fig. 15

L0D0166m

REFITTING THE STANDARD WHEEL

Following the procedure described previously, raise the car and remove the space saver spare wheel.

Versions with steel rims

Proceed as follows:

- Make sure the contact surfaces between standard wheel and hub are clean so that the fastening bolts will not come loose.
- Fit the standard wheel by inserting the first bolt for two threads into the hole closest to the inflation valve.

- Fit the wheel cup making the groove (on the cup) coincide with the inflation valve and then insert the other three bolts.
- For models with snap-on wheel cup, press the edge of the cup with the palm of your hands against the wheel (do not hammer).
- Using the wrench provided, tighten the fastening bolts.
- Lower the car and remove the jack.
- using the wrench provided, fully tighten the bolts in the sequence shown previously in figure **fig. 15**.

IMPORTANT Incorrect assembly may cause the cup to come off while travelling.

Versions with alloy rims

- ❑ Check that the hub contact surfaces are clean;
- ❑ fit the normal wheel centring it on the pins, lead in the fastening screws and tighten them using the wrench provided;
- ❑ lower the car and remove the jack;
- ❑ using the wrench provided, fully tighten the bolts in the sequence shown in **fig. 15**.
- ❑ snap fit the wheel cup on the hub.

When you have finished

- ❑ stow the spare wheel in the space provided in the boot;
- ❑ fit the jack partially open in its box forcing it lightly to prevent it from vibrating when travelling;
- ❑ put the tools back into their places in the container;
- ❑ arrange the container and tools in the spare wheel and secure the fastening device;
- ❑ rearrange the preformed boot cover correctly.

WHEN NEEDING TO CHANGE A BULB

GENERAL INSTRUCTIONS

- ❑ When a bulb is not working, check that the corresponding fuse is intact before replacing it: refer to the “If a fuse blows” paragraph in this chapter for fuse location.
- ❑ before changing a bulb check the contacts for oxidation;
- ❑ burnt bulbs must be replaced by others of the same type and power;
- ❑ always check the height of the headlight beam after changing a bulb.



Halogen lamps must be handled holding the metallic part only. Touching the transparent part of the bulb with your fingers may reduce the intensity of the emitted light and even compromise duration of the lamp itself.

**WARNING**

Modifications or repairs to the fuel feed system that are not carried out properly or do not take the system's technical specifications into account can cause malfunctions leading to the risk of fire.

**WARNING**

Halogen bulbs contain pressurised gas which, if broken, may cause small fragments of glass to be projected outwards.

IMPORTANT When the weather is cold or damp or after hard rain or after washing, the area of headlamps or rear lights, may steam up and/or form drops of condensation on the inside. This is a natural phenomenon due to the difference in temperature and humidity between the inside and the outside of the glass which does not indicate a fault and does not compromise the normal operation of lighting devices. The mist disappears quickly turning the lights on, starting from the centre of the diffuser, extending progressively towards the edges.

BULB TYPES fig. 16

Various types of bulbs are fitted to your car:

- A All glass bulb: clipped into place. Pull to extract.
- B Bayonet bulbs: to remove this type of bulb from its holder, press the bulb and turn it anticlockwise.
- C Cylindrical bulbs: release from the contacts to extract.
- D-E Halogen bulbs: release the fastening clip from the corresponding seat to remove the lamp.

**WARNING**

The taillights and the third brake light fit LEDs. Contact a Lancia Dealership in case of faults.

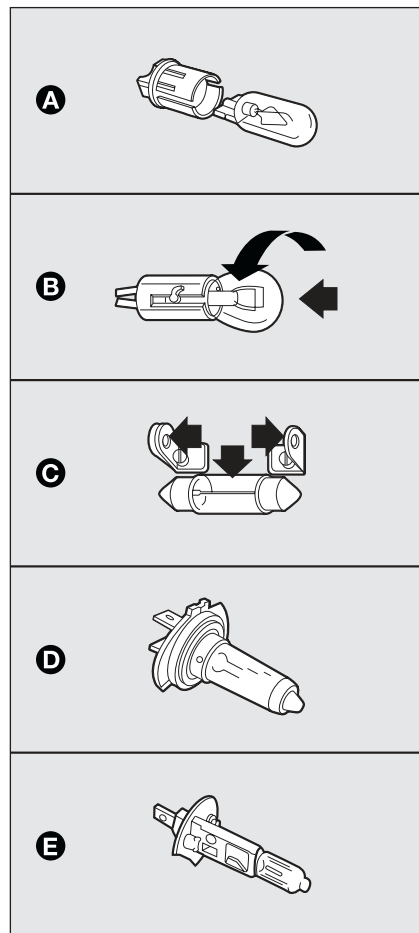

fig. 16

LOD0178m

Bulbs	Figure ref.	Type	Power
Main beam headlights	E	H1	55W
Dipped beam headlights	E	H1	55W
Front sidelights	A	W5W	5W
Front fog lights (for versions/markets, where provided)	E	H1	55W
Front direction indicators	B	PY21W	21W
Side direction indicators	A	WY5W	5W
Rear direction indicators	B	PY21W	21W
Reversing lights	B	P21W	21W
Rear fog lights	B	P21W	21W
Number plate lights	C	C5W	5W
Front ceiling light	A	W5W	10W
Rear ceiling light	A	W5W	10W
Rear ceiling lights (with sunroof)	A	W5W	5W
Boot light	A	W5W	5W

DASHBOARD
AND
CONTROLS

SAFETY

STARTING
AND DRIVING

WARNING
LIGHTS AND
MESSAGES

IN AN
EMERGENCY

MAINTENANCE
AND CARE

TECHNICAL
SPECIFICA-
TIONS

INDEX

REPLACING EXTERIOR BULBS

For the type of bulb and power rating, see “When needing to change a bulb”.



WARNING

Before replacing bulbs, wait for the engine to cool down: RISK OF BURNS!

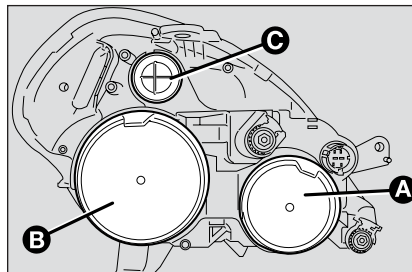

fig. 17

L0D0157m

FRONT LIGHT CLUSTER

The front light clusters contain side lights, dipped beam, main beam and direction indicator bulbs.

Remove the protective caps to remove the side lights, the dipped beam and the main beam headlights.

The bulbs are arranged inside the light cluster **fig. 17** as follows:

- A** dipped beam headlights
- B** main beam headlights and Side-lights
- C** direction indicators

After replacing, refit the protective caps and check that they are secured well.

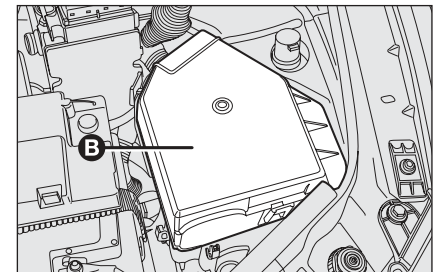

fig. 18

L0D0125m

IMPORTANT Remove the engine compartment fusebox **B-fig. 18** to access the left headlights cover (in direction of travel) for replacement.

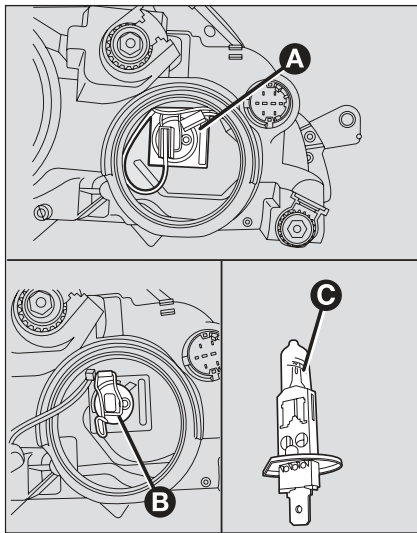

fig. 19

L0D0158m

DIPPED BEAM HEADLIGHTS

fig. 19

To replace the bulb, proceed as follows:

- remove the protective cap;
- disconnect the electrical connector **A**-fig. 19;
- release the bulb holder catch **B**, take out the bulb **C** and replace it;

- fit the new bulb, ensuring that the outline of the metal part coincides with the grooves on the curve of the headlight. Then reconnect the electrical connector **B** and refasten the bulb holder catch **A**;
- after replacing the bulb, put the protective cap back into position.

MAIN BEAM HEADLIGHTS

fig. 20

To replace the bulb, proceed as follows:

- remove the protective cap;
- disconnect the electric connector **A**-fig. 20;
- release the bulb holder catches **B**, take out the bulb **C** and replace it;
- fit the new bulb, ensuring that the outline of the metal part coincides with the grooves on the curve of the headlight. Then reconnect the electrical connector **B** and refasten the bulb holder catches **A**;
- after replacing the bulb, put the protective cap back into position.

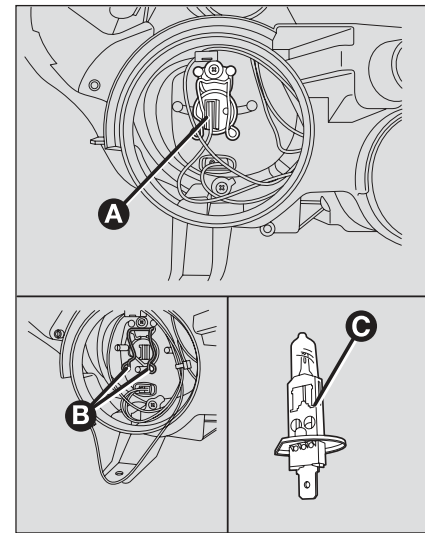

fig. 20

L0D0159m

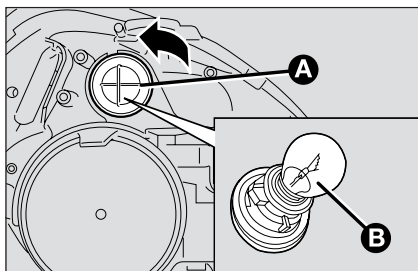

fig. 22

L0D0169m

DIRECTION INDICATORS

Front fig. 22

To change the bulb, proceed as follows:

- turn the bulb holder anticlockwise **A** and pull it out;
- remove the bulb **B** by pushing it slightly and turning it in an anticlockwise direction (bayonet mount);
- replace the bulb;
- refit the bulb holder by turning it clockwise and locking it properly.

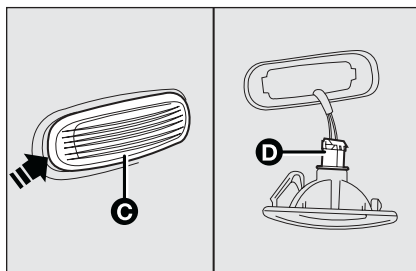

fig. 23

L0C0148m

Side fig. 23

To change the bulb, proceed as follows:

- lever in the point shown by the arrow in order to compress the fastening spring and extract the unit **C**;
- turn the bulb holder **D** anticlockwise, extract the clipped bulb and replace it;
- refit the bulb holder **D** in the lens, then position the assembly to the unit making sure that the fastening clip clicks.

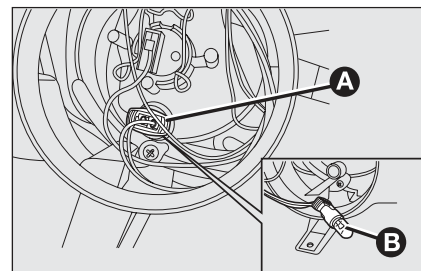

fig. 24

L0D0520m

SIDE LIGHTS fig. 24

To change the bulbs, proceed as follows:

- remove the protective cover releasing the relevant catch;
- remove snap-fitted bulb holder **A**, remove the bulb **B** and replace it;
- refit the snap-fitted bulb holder **A**;
- refit the protective caps correctly after replacing.

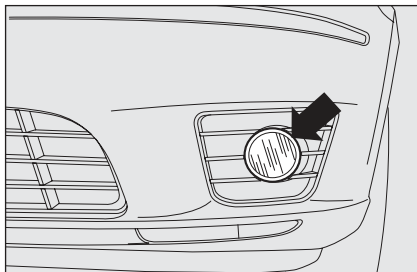

fig. 25

L0D0406m

FRONT FOG LIGHTS fig. 25

(for versions/markets, where provided)

Contact a Lancia Dealership to replace the front fog lights.

REAR LIGHT CLUSTERS

LEDs are used for the taillights and the brake lights. Contact a Lancia Dealership in case of faults.

To change a direction indicator bulb, proceed as follows:

- ❑ open the tailgate;
- ❑ turn the fastening device **A** anticlockwise (left flap) or clockwise (right flap) and remove the cover;
- ❑ disconnect the electric connector **C**;
- ❑ loosen the two fastening nuts **B**;
- ❑ to remove the light cluster, pull perpendicularly using the handle present on the light cluster body;
- ❑ press the bulb fastening tabs and extract the bulb;
- ❑ remove the bulb by pushing it slightly and turning it anticlockwise;

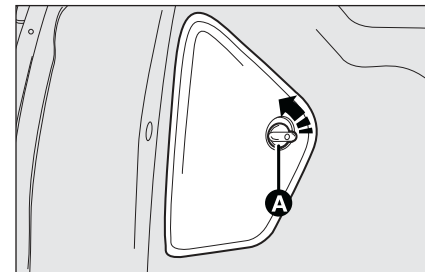

fig. 26

L0D0187m

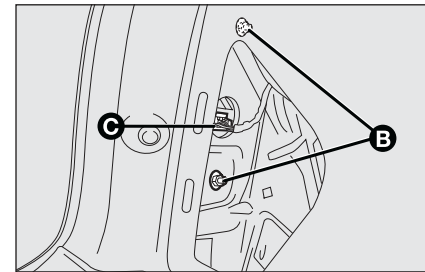

fig. 27

L0D0188m

- ❑ insert the bulb holder, making sure that the two tabs are correctly fastened; insert the light cluster inside the housing and connect the electric connector **C**; fasten the two nuts **B**; fasten the cover making sure that the tabs are inserted in the seat and turn the fastening device **A** anticlockwise (left flap) or clockwise (right flap) to secure it.

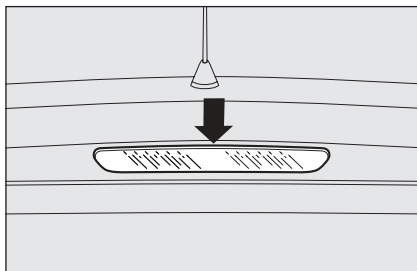

fig. 28

L0D0407m

THIRD BRAKE LIGHTS

The third brake light fits LEDs. Contact a Lancia Dealership in case of faults.

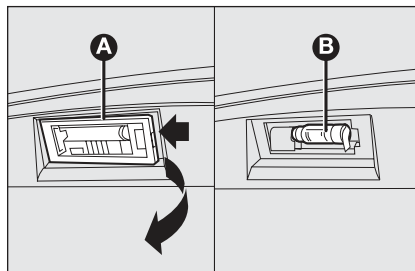

fig. 29/a

L0D0357m

NUMBER PLATE LIGHTS

fig. 29a

To change the bulbs, proceed as follows:

- apply pressure to the point shown by the arrow and remove lens **A**;
- change the bulb **B** releasing it from the side contacts and making sure the new bulb is correctly fastened between the contacts;
- withdraw the transparent cover assembly.

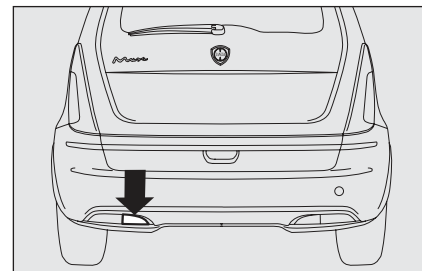

fig. 29/b

L0D0426m

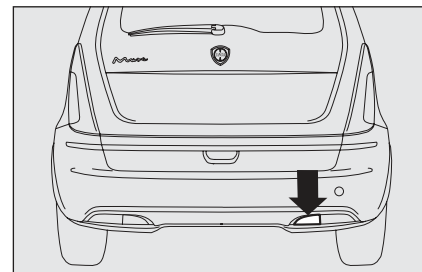

fig. 29/c

L0D0427m

REAR FOG LIGHTS fig. 29/b

Go to a Lancia Dealership to replace the rear fog light.

REVERSING LIGHTS fig. 29/c

Go to a Lancia Dealership to replace the reversing light.

REPLACING AN INTERIOR BULB

For the type of bulb and power rating, see “When needing to change a bulb”.

FRONT CEILING LIGHT

fig. 30-31

To change the bulbs, proceed as follows:

- operate in the points shown by the arrows and remove light **A**;
- open the protection lid **B**;
- replace bulbs **C** releasing them from the side contacts; make sure that new bulbs are correctly clamped between contacts;
- close the lid **B** and secure light **A** into its housing locking it properly.

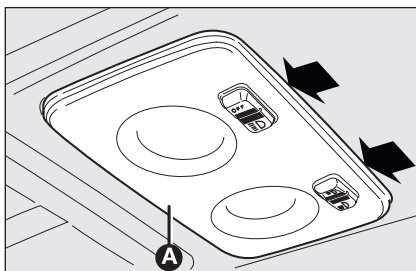

fig. 30

L0D0193m

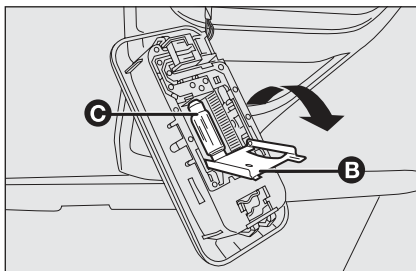

fig. 31

L0D0194m

REAR CEILING LIGHT

fig. 32-33

To change the bulbs, proceed as follows:

- operate in the points shown by the arrows and remove light **D**;
- open the protection lid **E**;

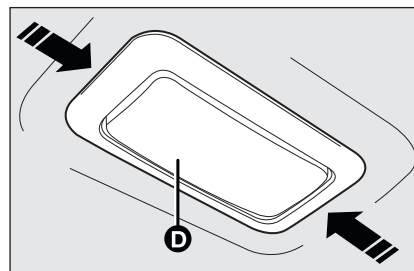

fig. 32

L0D0195m

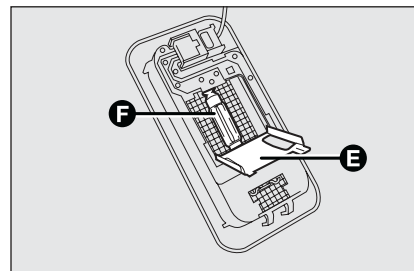

fig. 33

L0D0196m

- change the bulb **F** releasing it from the side contacts and making sure the new bulb is correctly fastened between the contacts;
- close the protection lid **E** and secure light **D** into its housing locking it properly.

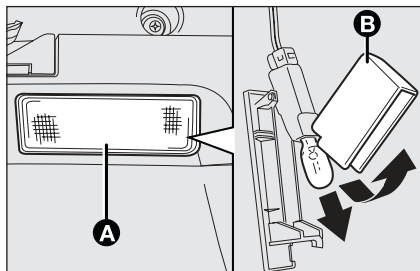

fig. 34

L0D0197m

BOOT LIGHT fig. 34

To change the bulb, proceed as follows:

- open the tailgate;
- remove the light **A** levering in the point shown by the arrow.
- open the protection **B** and replace the snap-fitted bulb;
- re-close the protective cover **B** on the lens;
- refit the light **A** inserting it in its correct position firstly on one end and then on the other until it clicks into place.

REPLACING FUSES

INTRODUCTION fig. 35

The fuse is a protective device for the electric system: it comes into action (i.e. it cuts off) mainly due to a fault or improper action on the system.

Check the efficiency of the corresponding fuse when a device does not work: the conducting element **A** must not be interrupted. If it is, replace the blown fuse with another with the same amperage (same colour).

B: intact fuse

C: fuse with damaged filament.

Use the tongs **D** in the fusebox on the dashboard to change a fuse.

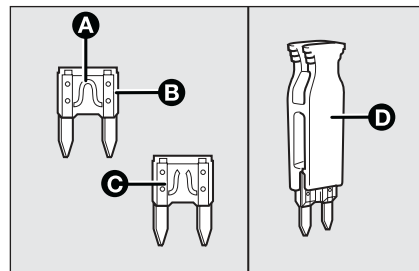

fig. 35

L0D0198m

**WARNING**

If a general protection fuse for safety systems (air bag system, braking system), power unit systems (engine system, transmission system) or steering system is triggered, contact a Lancia Dealership.

**WARNING**

If a fuse blows again, contact a Lancia Dealership.

**WARNING**

If a general protection fuse (MEGA-FUSE, MIDI-FUSE, MAXI-FUSE) blows, contact your Lancia Dealership



Never replace a fuse with another of higher amperage: FIRE RISK.

**WARNING**

Remove the key from the ignition switch and switch off all loads before replacing a fuse.

FUSE LOCATION

The fuses are contained in two dashboards, one on the dashboard on the left hand of the steering column and one in the engine compartment next to the battery.

Dashboard fusebox fig. 37

To access the dashboard fusebox, loosen the fastening screws **A**-fig. 36 and then remove the protection panel **B**.

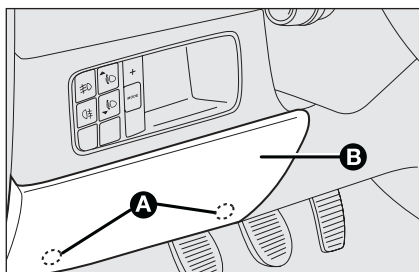

fig. 36

L0D0424m

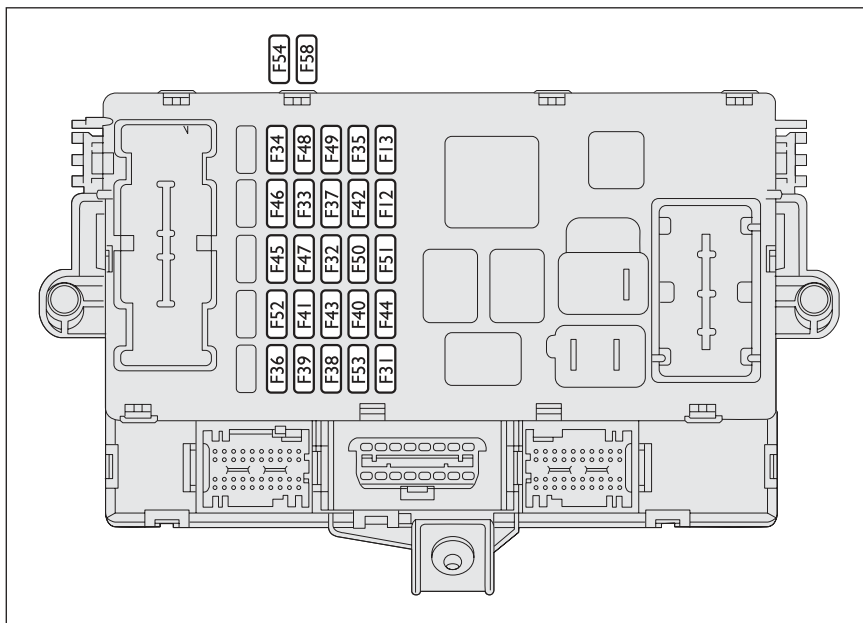

fig. 37

L0D0200m

DASHBOARD
AND
CONTROLS

SAFETY

STARTING
AND DRIVING

WARNING
LIGHTS AND
MESSAGES

IN AN
EMERGENCY

MAINTENANCE
AND CARE

TECHNICAL
SPECIFICA-
TIONS

INDEX

Fusebox next to the battery fig. 39

To gain access to the fuses in the fusebox next to the battery, remove the protection cover **B**-fig. 38.



If you need to wash the engine compartment, take care not to directly hit the engine compartment control unit with the water jet.

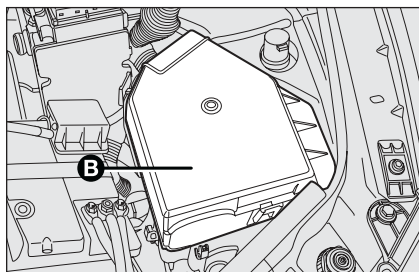

fig. 38

L0D0201m

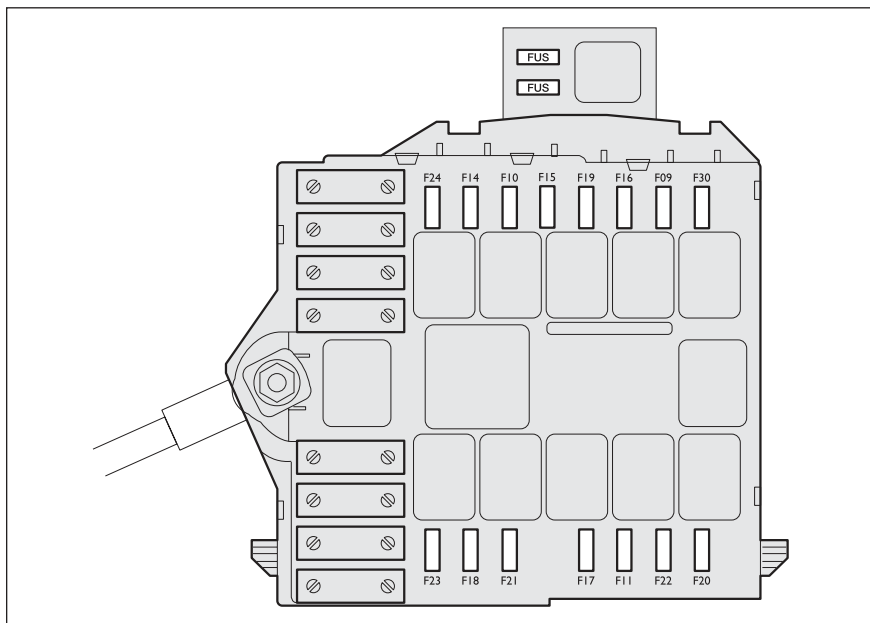

fig. 39

L0D0409m

FUSE TABLE

Dashboard fusebox fig. 37

USERS

	FUSE	AMPERES
Right dipped headlamp	F12	7.5
Left dipped headlamp/headlamp alignment corrector	F13	7.5
Engine compartment fuse box relay coils, body computer	F31	7.5
Rear left electric window	F33	20
Rear right electric window	F34	20
+15 Signal from switch on brake pedal for control units, reverse light/s, flow meter (MultiJet versions, Start&Stop excluded), heater plug control unit (1.3 MultiJet EURO 5 versions), clutch control (Start&Stop), brake servo (Start&Stop) and water sensor in diesel (*)	F35	7.5
Boot unlocking	F36	10
+15 Brake lights, instrument panel (*)	F37	7.5
Door lock, fuel flap actuator	F38	20
+30 Radio, navigator, Blue&Me™ system, electric window control unit, tyre pressure control unit, climate control, EOBD diagnosis socket (*)	F39	10
Heated rear window	F40	30
Heated electric mirrors	F41	7.5
Windscreen wiper, windscreen/rear window washer	F43	30
Cigar lighter / current socket on tunnel	F44	15
Heated front seats	F45	15
Luggage compartment current socket	F46	15
Driver's side front electric window	F47	20
Passenger 's side front electric window	F48	20
+15 Controls on the steering wheel, lighting for sun roof controls, left and centre dashboards, rain/dusk sensor, electric mirrors, heated front seat controls (*)	F49	7.5
+15 Navigator, radio setup, Blue&Me™ system, parking sensors, tyre pressure control unit, power window control unit, electric mirrors, climate control system knob lighting and ECO button, Cruise Control, voltage stabiliser (Start&Stop) (*)	F51	7.5
Rear window wiper	F52	15
+30 Instrument panel, rear fog lamp/s (*)	F53	7.5

(*) +30 = battery direct positive pole (not ignition switch)

+15 = positive pole ignition switch

DASHBOARD
AND
CONTROLS

SAFETY

STARTING
AND DRIVING

WARNING
LIGHTS AND
MESSAGES

IN AN
EMERGENCY

MAINTENANCE
AND CARE

TECHNICAL
SPECIFICA-
TIONS

INDEX

Fusebox in engine compartment fig. 39**USERS**

	FUSE	AMPERES
Horn	F10	15
Right beam	F14	7.5
Left beam	F15	7.5
Compressor	F19	7.5
Starting system (Start&Stop)	F20	30
Fuel pump	F21	15
Fog lights	F30	15

(*) +30 = battery direct positive pole (not ignition switch)

+15 = positive pole ignition switch

Optional fusebox (on auxiliary bracket) fig. 37**USERS**

	FUSE	AMPERES
+30 External radio amplifier (*)	F54	15
+30 Sunroof (*)	F58	20

(*) +30 = battery direct positive pole (not ignition switch)

+15 = positive pole ignition switch

IF THE BATTERY IS FLAT

IMPORTANT The battery recharging procedure is provided as an example only. You are recommended to go to a Lancia Dealership to have this operation performed.

Low amperage slow recharging for approximately 24 hour is advised. A long charge could damage the battery. Proceed as follows to charge the battery:

- disconnect battery negative terminal;
- connect the charger cables to the battery terminals, observing the poles;
- turn on the charger;
- when you have finished, turn the charger off before disconnecting the battery;
- reconnect battery negative terminal.

IMPORTANT If the car is equipped with an alarm system, disarm the alarm system by means of the remote control (see “Alarm” paragraph in “Dashboard and controls”).



WARNING

Battery fluid is poisonous and corrosive: avoid contact with your skin and eyes. The battery recharging operation must be performed in a ventilated place away from naked flames or possible sources of sparks to avoid the risk of explosion and fire.



WARNING

Never attempt to recharge a frozen battery: defrost it first to prevent the risk of explosion. If a battery was frozen, have it inspected by specialised personnel before recharging to check that the internal elements are not damaged and that the casing is not cracked causing the risk of leakage of poisonous, corrosive gas.

LIFTING THE CAR

If the car is to be lifted, go to a Lancia Dealership which is equipped with the arm hoist or workshop lift.

Lift the car exclusively by positioning the jack arms or the shop jack in the points shown in the figure.

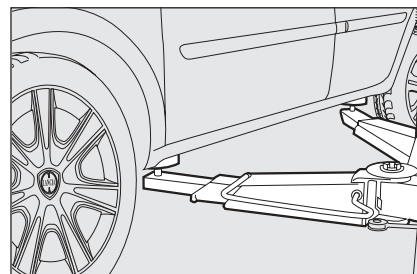

fig. 40

L0D0486m

DASHBOARD
AND
CONTROLS

SAFETY

STARTING
AND DRIVING

WARNING
LIGHTS AND
MESSAGES

IN AN
EMERGENCY

MAINTENANCE
AND CARE

TECHNICAL
SPECIFICATIONS

INDEX

TOWING THE CAR

The car is provided with two tow rings: use the shorter one on the front and the longer one on the back.

The tow rings are arranged inside the tool container.

The arrangement of the rear ring (long) inside the spare wheel and inside the automatic Fix & Go quick repair kit are shown in **fig. 41** and in **fig. 42** respectively.

On cars with Dual Function System gearbox, make sure that the gearbox is in neutral N (check that the car can move when pushed) and tow as a normal car with mechanical gearbox.

If the gearbox cannot be placed in neutral, do not tow the vehicle and contact a Lancia Dealership.

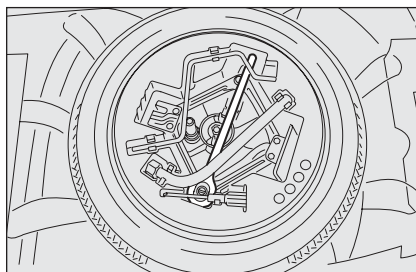

fig. 41

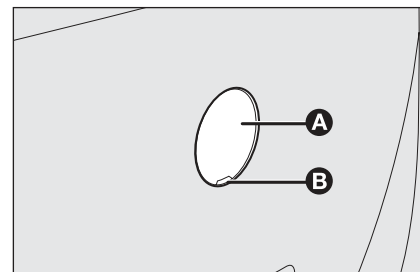

fig. 43

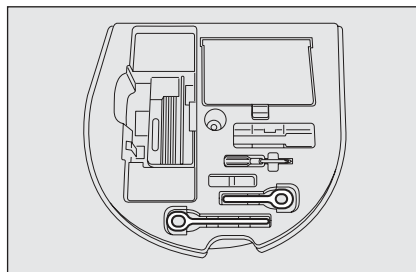

fig. 42

REMOVING THE TOW HITCH CAPS

To avoid damaging the cap **A-fig. 43**, proceed as follows:

- take the screwdriver from the tool container;
- insert the screwdriver in the slot **B** on the cap;
- rest your thumb on the cap to avoid damage (see figure);
- extract the cap (without turning it) perpendicular to the supporting surface **fig. 44**.

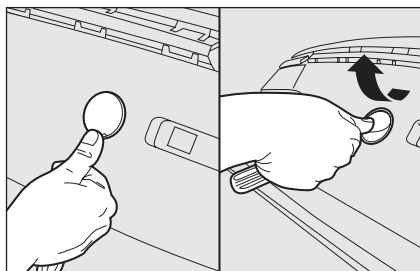

fig. 44

L0D0251m

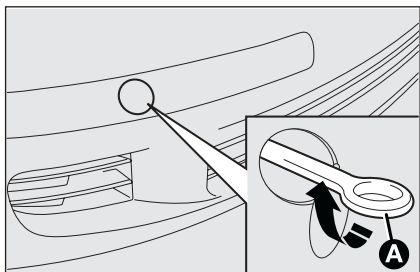

fig. 45

L0D0487m

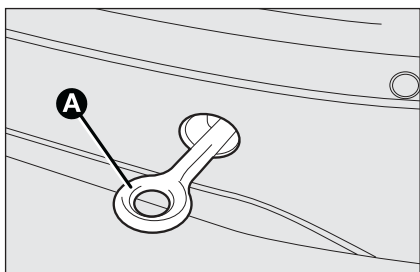

fig. 46

L0D0205m

FASTENING THE TOW RING

Proceed as follows:

- ❑ take the tow hook **A** from the support;
- ❑ tighten the ring on the rear **fig. 46** or front **fig. 45** threaded pin.



WARNING

*Before towing, turn the key to **MAR** and then to **STOP** without extracting it. The steering column will automatically lock when the key is removed and the wheels cannot be steered.*



WARNING

The power brakes and power steering will not work while the car is being towed. More effort on the brake pedal and steering wheel will therefore be required. Do not use wires for towing. Do not jerk. Make sure not to damage parts in contact with the car while towing. Respect the specific rules of the Highway Code when towing the car specifically in relation to the towing device and the behaviour to maintain on the road.



WARNING

Do not start the engine while towing the car.

**WARNING**

Before fitting the hook, clean accurately its threaded seat. Before starting to tow, make sure to have tighten the hook.



*The front and rear tow hooks must only be used for emergency situations on the road. The vehicle may be towed for short distances when a dedicated device is used in compliance with the Highway Code (rigid bar), in order to move the vehicle on the road in preparation for towing by a tow truck. Tow hooks **MUST NOT** be used to tow vehicles off the road or where there are obstacles and/or for towing operations using cables or other non-rigid devices. Respecting the above conditions, towing must only take place with two vehicles (one towing, the other towed) travelling as far as possible in alignment along the same centre-line.*

MAINTENANCE AND CARE

SCHEDULED SERVICING	166
SERVICE SCHEDULE	167
YEARLY INSPECTION PLAN	169
ADDITIONAL INTERVENTIONS	169
CHECKING THE LEVELS	171
FUEL FILTER (green filter)	177
BATTERY	177
WHEELS AND TYRES	179
RUBBER HOSES	180
WINDSCREEN/REAR WINDOW WIPER/WASHER	181
BODYWORK	182
INTERIORS	185

DASHBOARD
AND
CONTROLS

SAFETY

STARTING
AND DRIVING

WARNING
LIGHTS AND
MESSAGES

IN AN
EMERGENCY

MAINTENANCE
AND CARE

TECHNICAL
SPECIFICA-
TIONS

INDEX

SCHEDULED SERVICING

Correct maintenance is essential for ensuring long car life under the best conditions.

This is why Lancia has planned a series of checks and maintenance operations every 20,000 km.

Scheduled servicing will not however fully cover all of the need of your car: It is however important to remember that scheduled servicing does not completely cover all the car's requirements: also in the initial period before 20.000 km service coupon and later, between one coupon and another, ordinary care is still required such as for example routine check and topping up the level of fluids, tyre pressure check, etc.

IMPORTANT Scheduled service coupons are required by the manufacturer. Default may cancel the warranty.

Scheduled Servicing is performed by all Lancia Dealerships at pre-established times.

If during each operation, in addition to the ones programmed, the need arises for further replacements or repairs, these may only be carried out with the explicit agreement of the Customer.

IMPORTANT You are advised to contact Lancia Dealership in the event of any minor operating faults, without waiting for the next service coupon.

If your car is used frequently for towing, the interval between one service coupon and the other must be reduced.

SERVICE SCHEDULE

Thousands of kilometres	20	40	60	80	100	120	140	160	180
Check tyre condition/wear and, if necessary, adjust pressure	●	●	●	●	●	●	●	●	●
Check lighting system operation (headlights, direction indicators, hazard lights, boot, passenger compartment, oddment compartments, instrument panel warning lights, etc.)	●	●	●	●	●	●	●	●	●
Check windscreen wiper/washer (nozzle direction and blade wear)	●	●	●	●	●	●	●	●	●
Check conditions and wear of front disk brake pads and operation of pad wear indicator	●	●	●	●	●	●	●	●	●
Check rear drum brake linings and wear			●			●			●
Check condition and wear of rear brake discs (for versions/markets, where provided)		●		●		●		●	
Visually inspect the condition of: exterior bodywork, underbody protection, flexible and stiff piping (exhaust, fuel feed, brakes), rubber parts (boots, sleeves, bushings, etc.)	●	●	●	●	●	●	●	●	●
Check cleanness of locks, bonnet and boot and lever cleanness and lubrication	●	●	●	●	●	●	●	●	●
Check tension and conditions of various accessory drive belts (except for engines with automatic take-up devices)	●						●		
Inspect conditions of various drive belts			●						●
Check and adjust tappets (1.48V versions)			●			●			●
Check battery charge status and possibly recharge	●	●	●	●	●	●	●	●	●

DASHBOARD
AND
CONTROLS

SAFETY

STARTING
AND DRIVING

WARNING
LIGHTS AND
MESSAGES

IN AN
EMERGENCY

MAINTENANCE
AND CARE

TECHNICAL
SPECIFICA-
TIONS

INDEX

	Thousands of kilometres	20	40	60	80	100	120	140	160	180
DASHBOARD AND CONTROLS	Check handbrake stroke adjustment		●		●		●		●	
	Check exhaust emissions/smokiness (Multijet engines).		●		●		●		●	
	Check emissions in exhaust (petrol versions)		●		●		●		●	
SAFETY	Replace fuel filter (Multijet versions)			●			●			●
	Replace air cleaner filter (petrol versions)			●			●			●
STARTING AND DRIVING	Replace air cleaner filter (diesel versions) (☐)			●			●			●
	Top-up liquid level (engine coolant, brakes, windscreen washer, battery, Dual Function System etc...)	●	●	●	●	●	●	●	●	●
	Check timing belt conditions (■)			●						●
WARNING LIGHTS AND MESSAGES	Replace timing belt (*) (■)						●			
	Replace timing belt (1.6 Multijet versions) (*)							●		
	Replace auxiliary drive belt						●			
IN EMERGENZA	Replace spark plugs (petrol versions)		●		●		●		●	
	Check operation of engine management systems (using diagnostic socket)		●		●		●		●	
	Replace engine oil and oil filter (petrol versions)	●	●	●	●	●	●	●	●	●
MAINTENANCE AND CARE	Change engine oil and oil filter (Multijet versions with DPF) (**), (▲)									
	Change engine oil and oil filter (Multijet versions without DPF) (▲)									
	Change brake fluid (or every two years)			●			●			●
TECHNICAL SPECIFICATIONS	Replace pollen filter (or once a year)	●	●	●	●	●	●	●	●	●
	Check battery charge status and possibly recharge	●	●	●	●	●	●	●	●	●

(*) Or every 4 years if the vehicle is used in one of the following particularly demanding conditions:

- prolonged use in cold/hot climates,
- city use with long standing with engine idling,
- use on particular dusty roads or roads sprinkled with sand and/or salt.

Or every five years regardless of mileage and conditions of use of the car.

(**) The engine oil and the filter must be changed when instrument panel warning light comes on (see "Warning lights and messages" chapter) or however every 2 years.

(☐) Every 30,000 km for 1.3 Multijet versions. (■) Excluding 1.3 Multijet and 1.6 Multijet versions. (▲) Every 30,000 km

(▲) If the car is used mainly in towns the engine oil and filter need to be changed every 12 months.

YEARLY INSPECTION PLAN

The following yearly inspection plan is recommended for cars clocking less than 20,000 km a year (e.g. approximately 15,000 km):

- check tyre conditions/wear and pressure (included spare wheel)
- check lighting system operation (headlights, direction indicators, hazard lights, boot, passenger compartment, instrument panel warning lights, etc.)
- check windscreen wiper/washer (nozzle direction and blade wear)
- check front disk brake pad conditions and wear;
- visually inspect: engine, gearbox, transmission, flexible and stiff piping (exhaust, fuel feed, brakes), rubber parts (boots, sleeves, bushings, etc.);
- check cleanness of locks, bonnet and boot and lever cleanness and lubrication;
- check battery charge;
- visually inspect the accessory drive belt conditions;
- check and top up liquids if required (engine coolant, brakes, windscreen washer, battery, etc.);
- engine oil replacement;
- replace engine oil filter;
- replace pollen filter (for versions/markets, where provided).

ADDITIONAL INTERVENTIONS

Every 1,000 km or before long journeys, check and, if necessary, top up:

- engine coolant fluid level;
- brake fluid level;
- brake fluid level;
- tyre pressure and conditions.

Every 3,000 km check the following and top-up, if required: engine oil level.

You are recommended to use PETRONAS LUBRICANTS products, designed and produced specifically for Lancia cars (see table “Capacities” in section “Technical specifications”).

IMPORTANT - Engine oil

Should prevailing use of the car be under one of the following specially heavy conditions:

- trailer or caravan towing;
- dusty roads;

DASHBOARD AND CONTROLS

SAFETY

STARTING AND DRIVING

WARNING LIGHTS AND MESSAGES

IN AN EMERGENCY

MAINTENANCE AND CARE

TECHNICAL SPECIFICATIONS

INDEX

- ❑ short distances (less than 7-8 km) repeated and with external temperatures below zero;
- ❑ frequently idling engines or long distance low speed driving (e.g. taxis or door-to-door deliveries) or in case of a long term inactivity;
- ❑ change engine oil more frequently than shown on the “Service Schedule”.

IMPORTANT - Air cleaner

When the car is used on dusty roads, change the air cleaner more frequently than shown on the “Service Schedule”. Call a Lancia Dealership for doubts regarding engine oil and air cleaner replacement.

IMPORTANT - Pollen filter

It is advisable to replace the filtering element more frequently if the car is used in dusty or very polluted places. Specifically, replace if a lower air flow into the passenger compartment is found.

IMPORTANT - Diesel filter

Using diesel not complying with European Specification EN590 may lead to the need to replace the diesel fuel filter more frequently than shown in the “Service Schedule”.

IMPORTANT - Battery

Check the battery charge once a year, preferably before the beginning to winter, to prevent freezing of the electrolyte.

Perform this inspection more frequently if the car is mainly used for short distances or if electrical devices running with the key off are installed, particularly after-market. Check the battery level (electrolyte) more frequently than shown on the “Service Schedule” if the car is used in hot climates or in particularly demanding conditions.



Take the car to a Lancia Dealership for servicing. Make sure you have the right equipment, genuine Lancia spare parts and consumables for ordinary, minor interventions. Do not attempt the operations if you lack the experience.

CHECKING THE LEVELS



Be careful not to confuse the various types of fluids while topping up: they are all reciprocally incompatible and may severely damage your car.



WARNING

Never smoke while working in the engine compartment. Flammable gases may be present. Risk of fire.

1 Engine coolant - 2 Engine oil -
3 Brake fluid - 4 Battery - 5 Wind-
screen/rear window washer/wiper

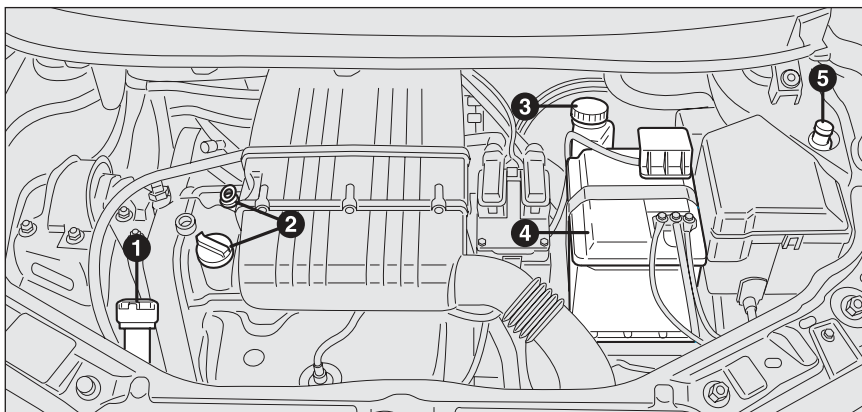

fig. 1 - 1.4 8V versions (for versions/markets, where provided)

L0D0412m

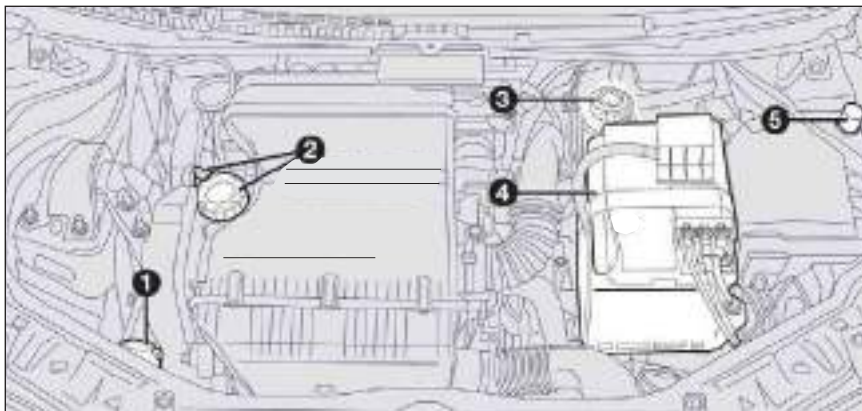

fig. 2 - 1.4 16V versions

L0D0412m

DASHBOARD
AND
CONTROLS

SAFETY

STARTING
AND DRIVING

WARNING
LIGHTS AND
MESSAGES

IN AN
EMERGENCY

MANUTENZIONE
E CURA

TECHNICAL
SPECIFICA-
TIONS

INDEX

1 Engine coolant - 2 Engine oil -
3 Brake fluid - 4 Battery - 5 Wind-
screen/rear window washer/wiper

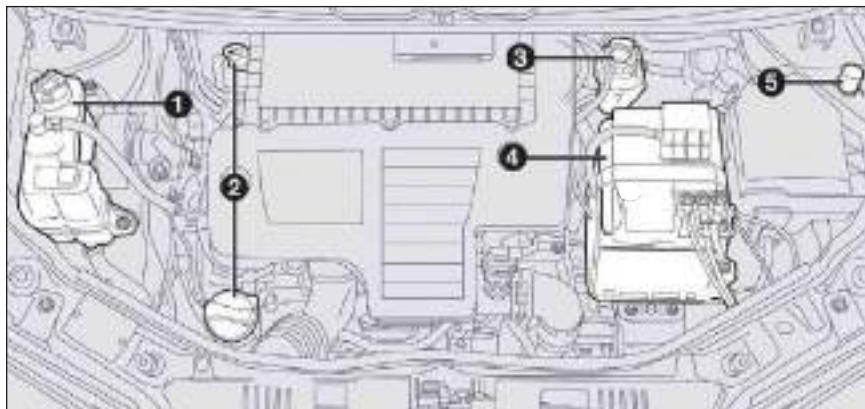

fig. 3 - 1.3 Multijet versions

L0D0413m

1 Engine coolant - 2 Engine oil -
3 Brake fluid - 4 Battery - 5 Wind-
screen/rear window washer/wiper

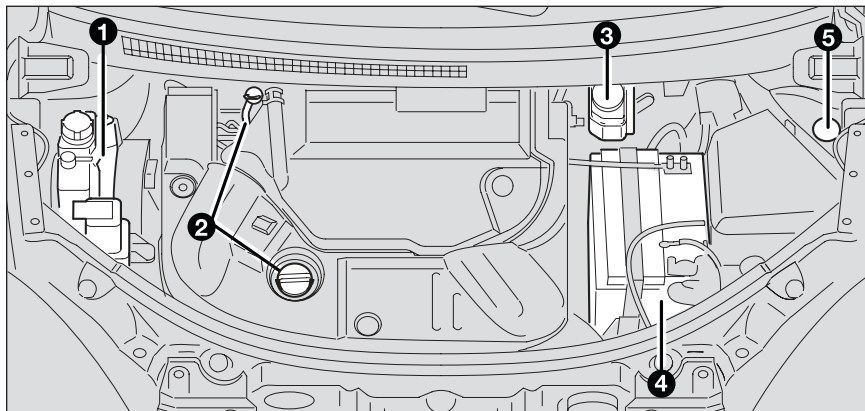

fig. 4 - 1.3 Multijet 95 HP versions

L0D0494m

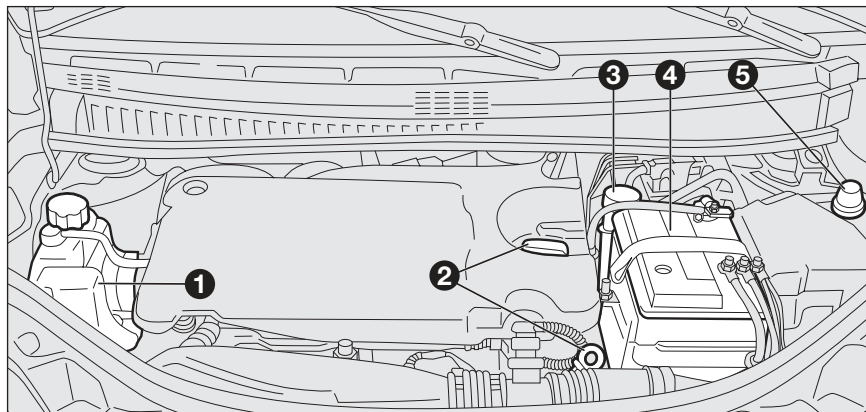

fig. 5 - 1.6 Multijet versions

L0D0488m

1 Engine coolant - 2 Engine oil - 3 Brake fluid - 4 Battery - 5 Windscreen/rear window washer/wiper

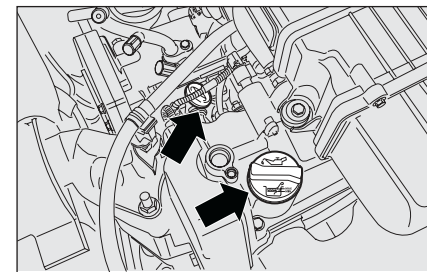

fig. 6 - 1.4 8V versions
(for versions/markets, where provided)

L0D0258m

ENGINE OIL fig. 6-7-8-9-10

Checking engine oil level

Check the oil level a few minutes (about 5) after the engine has stopped, with the car parked on level ground.

The oil level shall be included between the **MIN** and **MAX** marks on the dipstick . The range between the **MIN** and **MAX** levels corresponds to approximately 1 litre of oil.

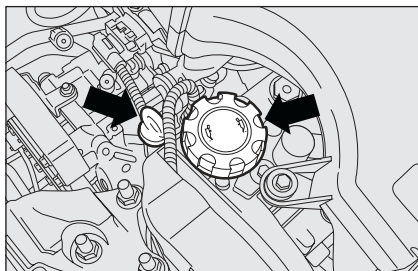

fig. 7 - 1.4 16V versions

L0D0208m

Topping up engine oil

If the oil level is near or even under the **MIN** line, add oil through the filler to reach the **MAX** line. Oil level shall never exceed the **MAX** line.

IMPORTANT If the engine oil level after the check is over the **MAX** level, go to a Lancia Dealership to have the correct level restored.

IMPORTANT After adding or changing the oil, let the engine turn over for a few seconds and wait a few minutes after turning it off before you check the level.

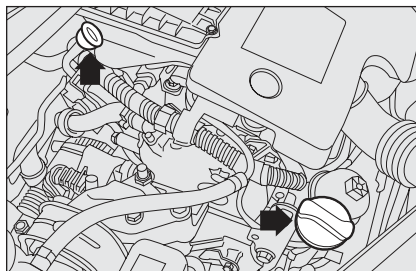

fig. 8 - 1.3 Multijet versions

L0D0209m

Engine oil consumption

The maximum engine oil consumption is usually 400 grams every 1000 km.

When the car is new, the engine needs to run in, therefore the engine oil consumption can only be considered stabilised after the first 5000 - 6000 km.

IMPORTANT The oil consumption depends on driving style and the conditions under which the car is used.

IMPORTANT Always top up using engine oil of the same types as that already in the engine.

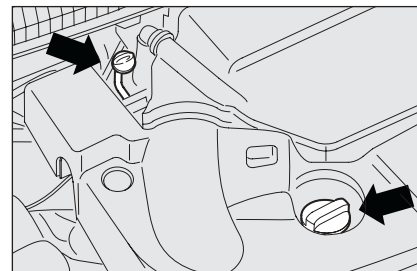

fig. 9 - 1.3 Multijet 95 HP versions

L0D0495m



WARNING

Proceed very carefully inside the engine compartment when the engine is hot: risk of burns. Remember that the fan may start up if the engine is hot: risk of injury. Pay attention to scarves, ties and other loose fitting garments: they could get dragged by the moving parts.



Waste engine oil and oil filters contains substances which are dangerous for the environment. You are advised to go to a Lancia Dealership to have the oil and filters replaced.

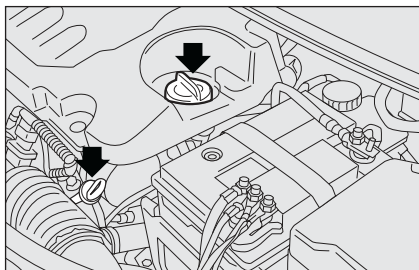

fig. 10 - 1.6 Multijet versions

L0D0489m

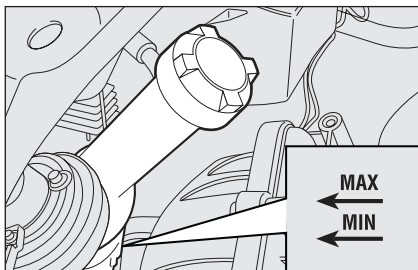

fig. 11 - 1.4 8V versions
(for versions/markets,
where provided) and 1.4 16V

L0D0210m

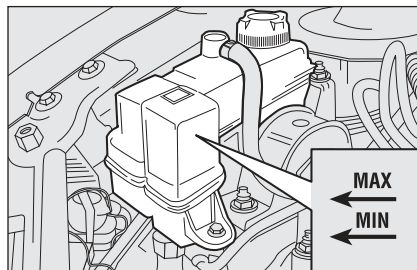

fig. 12 - 1.3 Multijet
and 1.6 Multijet versions

L0D0211m

ENGINE COOLANT fig. 11-12

The coolant level must be checked when the engine is cold and must be between the **MIN** and **MAX** lines on the vessel.

If the level is so, slowly pour a mixture of demineralised water and PETRONAS LUBRICANTS **PARAFLU^{UP}** in a 50-50 proportion.

A 50-50 mixture of **PARAFLU^{UP}** and distilled water gives freeze protection to 35°C.

IMPORTANT Do not remove the cap from the vessel when the engine is very hot: risk of burns.

When the vehicle is used under particularly harsh weather conditions, we recommend using a 60-40 mixture of **PARAFLU^{UP}** and demineralised water.



WARNING

PARAFLU^{UP} antifreeze is used in the engine cooling system. Use fluid of the same type contained in the cooling system for top-ups. PARAFLU^{UP} may not be mixed with other types of fluids. If this accidentally occurs, do not start the engine and contact a Lancia Dealership.



WARNING

The engine cooling system is pressurized. If required, replace the cap with an original spare part so as not to compromise system efficiency.

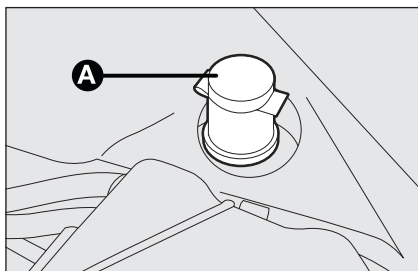

fig. 13

L0D0212m

WINDSCREEN/REAR WINDOW WASHER FLUID fig. 13

To add fluid, lift the cap **A** and pour in a mixture of water and **TUTELA PROFESSIONAL SC35** fluid in the following proportions:

- 30% of **TUTELA PROFESSIONAL SC35** and 70% water in summer.
- 50% of **TUTELA PROFESSIONAL SC35** and 50% water in summer.

Use **TUTELA PROFESSIONAL SC35** neat at temperatures lower than 20°C.

Check level through the reservoir.

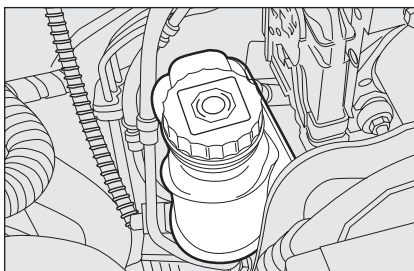

fig. 14

L0D0213m

BRAKE FLUID fig. 14

Release cap: check that the liquid contained in the tank is at the maximum level.

Fluid level in the reservoir must not exceed the **MAX** mark.

Use the brake fluid shown in the “Fluids and lubricants” table (see “Technical Specifications”).

NOTE Carefully clean the cap of reservoir **A** and the surrounding surface.

When opening the cap, make sure that no dirt gets into the reservoir.

For topping up always use a funnel with built-in filter (mesh smaller than or equal to 0.12 mm).

IMPORTANT Brake fluid is hygroscopic (i.e. it absorbs moisture). For this reason, if the car is mainly used in areas with a high degree of atmospheric humidity, the fluid should be replaced at more frequent intervals than specified in the “Service schedule”.



WARNING

Some commercial additives for windscreen washing are flammable. The engine compartment contains hot parts which could start a fire if they come into contact.



WARNING

Do not travel with the windscreen washing reservoir empty; the action of the windscreen washer is essential for improving visibility.



Prevent brake fluid which is highly corrosive from coming into contact with painted parts. Should this occur, immediately wash with water.



WARNING

Brake fluid is poisonous and highly corrosive. In the case of accidental contact, wash the parts with water and mild soap and rinse with plenty of water. Call a doctor immediately if swallowed.



WARNING

Symbol © on the contain indicates a synthetic brake fluid, which is different from a mineral fluid. Use of a mineral type fluid will damage the special rubber seals of the braking system beyond repair.

FUEL FILTER (green filter)

DRAINING CONDENSATION (Multijet versions)



WARNING

The presence of water in the feeding circuit may cause severe damage to the injection system and irregular engine operation. If the warning lights  on the cluster lights up or a message appears on the reconfigurable multifunctional display (some versions), contact a Lancia Dealership to have the system bled. Water may have been introduced in the tank if this appears immediately after refuelling: in this case, stop the engine immediately and contact a Lancia Dealership.

BATTERY

The battery is of the low maintenance type and the electrolyte does not need to be topped up with distilled water in normal conditions of use.

CHECKING CHARGE AND ELECTROLYTE LEVEL

The operations must be carried out as described in this Owner's Handbook only by specialised personnel.

Topping must be carried out by specialised personnel at a Lancia Dealership.



WARNING

Battery liquid is poisonous and corrosive. Avoid contact with the skin and eyes. Keep naked flames and sources of sparks away from the battery: risk of explosion and fire.

**WARNING**

Running the battery with an excessively low liquid level will damage the battery beyond repair and even cause an explosion.

CHANGING THE BATTERY

If required, replace the battery with a genuine spare part having the same specifications.

If a battery with different specifications is fitted, the service intervals given in the "Service schedule" in this section will no longer apply.

Follow the battery manufacturer's instructions for maintenance.



Incorrect assembly of electric and electronic devices may cause severe damage to your car. Go to a Lancia Dealership if you want to install accessories (alarms, mobile phone, etc.): they will suggest the most suitable devices and advise you if a higher capacity battery needs to be installed.



Batteries contain very dangerous substances for the environment. You are recommended to go to a Lancia Dealership to have the battery replaced where the old battery will be disposed of respecting both the environment and the laws in force.

**WARNING**

If the car is left for long periods in very cold environments, remove the battery and store it in a warm place to prevent freezing.

**WARNING**

Always wear the proper protective eyewear when working on the battery or near it.

USEFUL ADVICE FOR LENGTHENING THE LIFE OF YOUR BATTERY

To avoid draining your battery and lengthen its life, observe the following indications:

- when the car is parked, make sure that the doors, bonnet and tailgate are closed properly to make sure that the lights inside the passenger compartment go out;
- switch off all lights inside the vehicle: the car is however equipped with a system which switches all internal lights off automatically;
- do not keep devices (e.g. sound system, hazard lights, etc.) on for a long time with the engine off;
- before performing any operation on the electrical system, disconnect the battery negative cable;
- battery terminals shall always be perfectly tightened.

IMPORTANT A battery which is kept at a charge of less than 50% (optical indicator with dark colour without green area in the middle) for any length of time will be damaged by sulphation leading to a reduction in cranking power.

The battery will also be more at risk of freezing (e.g. already at -10°C).

In case of prolonged halt, refer to the “Storing the car” paragraph in the “Starting and driving” chapter.

If after buying the car, you want to install electric accessories which require permanent electric supply (alarm, etc.) contact Lancia Dealership whose qualified personnel, in addition to suggesting the most suitable devices from Lineaccessori Lancia, will evaluate the overall electric absorption, checking whether the car’s electric system is capable of withstanding the load required, or whether it should be integrated with a more powerful battery.

Since these devices continue absorbing energy even when the ignition key is off, they gradually run down the battery.

WHEELS AND TYRES

Check the pressure of each type, including the spare, approximately once every two weeks and before starting a long journey: this check must be performed with the tyre rested and cold.

It is normal for pressure to increase when the car is used. For the correct tyre inflation pressure, see “Wheels” in “Technical specifications” section.

Incorrect pressure causes abnormal tyre wear **fig. 15**:

A: normal pressure: evenly worn tread.

B: low pressure: tread particularly worn on the edges.

C: excessive pressure: tread particularly worn in the middle.

The tyres must be replaced when the tread is less than 1.6 mm thick. In all cases, follow the laws in force in the country where you are driving.

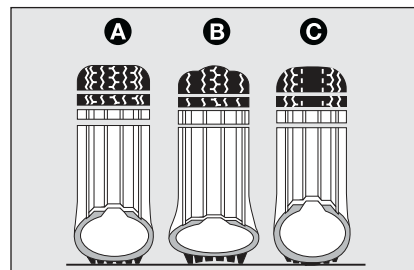

fig. 15

L0D0216m

IMPORTANT NOTES

- Avoid braking suddenly, burning starts and violent knocks against the curb, potholes or other obstacles if possible. Long distances on rough roads may damage the tyres;
- check the tyres regularly for cuts on the sides, swelling or irregular tread wear. Go to a Lancia Dealership if required.
- Do not overload your vehicle: this may cause serious damage to wheels and tyres;
- if a tyre is punctured, stop the vehicle immediately and charge it to avoid damage to the tyre, the rim, suspensions and steering system;

DASHBOARD
AND
CONTROLS

SAFETY

STARTING
AND DRIVING

WARNING
LIGHTS AND
MESSAGES

IN AN
EMERGENCY

MAINTENANCE
AND CARE

TECHNICAL
SPECIFICATIONS

INDEX

- ❑ a tyre will age even if it is not used much. Cracks in the tread and on the sidewalls are a sign of ageing. Have the tyres checked by specialised personnel if they have been fitted for longer than 6 years. Remember to check the spare wheel very carefully;
- ❑ In case of replacement, always fit new tyres, avoiding those with an unknown origin.
- ❑ If a tyre is replaced, also change the inflation valve.
- ❑ to allow even wear between the front and rear tyres, it is advisable to change them over every 10-15 thousand kilometres, keeping them on the same side of the car so as not to reverse the direction of rotation.

**WARNING**

Remember that the road holding qualities of your car also depends on the correct inflation pressure of the tyres.

**WARNING**

Excessively low pressure will cause overheating of the tyre and may cause severe tyre damage.

**WARNING**

Do not exchange the tyres from the left to the right of the car and vice versa.

**WARNING**

Do not repaint alloy wheel rims at temperatures higher than 150°C. The mechanical features of the wheels could be compromised.

RUBBER HOSES

Carefully follow the information contained in the “Service schedule” in this section for maintenance of brake system and fuel feed rubber hoses.

Ozone, high temperatures and prolonged lack of fluid in the system may cause hardening and cracking of the hoses, with possible leaks. Careful inspections are therefore necessary.

WINDSCREEN/REAR WINDOW WIPER/WASHER

BLADES

Periodically clean the rubber part using special products; **TUTELA PROFESSIONAL SC 35** is recommended.

Replace the blades if the rubber edge is deformed or worn. In all cases, it is advisable to replace them approximately once a year.

A few simple precautions can reduce the possibility of damage to the blades:

- make sure that the rubber part is not stuck to the windscreen at sub-zero temperatures. Use an antifreeze product to release it if required.
- remove the snow from the window: this will avoid overstressing the electrical motor in addition to protecting the blades;
- do not operate the windscreen and rear window wipers on dry glass.

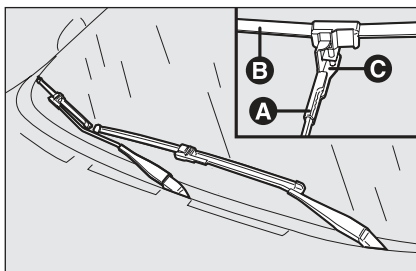
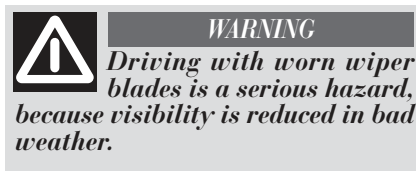

fig. 16



Replacing the windscreen wiper blades fig. 16

How to remove the blade:

- raise the windscreen wiper arm **A** from the windscreen;
- turn blade **B** 90° around pin **C**, located at the end of the wiper arm;
- remove the blade from pin **C**.

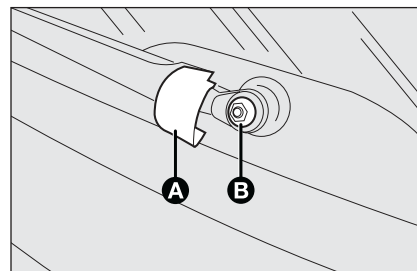

fig. 17

How to insert the blade:

- insert the pin **C** in the hole in the middle of the blade **B**;
- refit the arm with the blade on the windscreen.

Replacing the rear window blade fig. 17

Proceed as follows:

- lift the cover **A** and remove the arm from the car, loosen the nut **B** which fastens it to the rotating pin;
- position the new arm correct and tighten the nut;
- lower the cover.

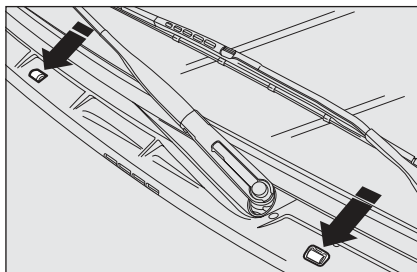

fig. 18

SPRAY NOZZLES

Windscreen washer fig. 18

If there is no jet of fluid, firstly check that there is fluid in the reservoir: see “Checking fluid levels” in this section).

Then check that the nozzle holes are not clogged, if necessary using a needle.

The front window nozzle do not need to be adjusted. The liquid is atomised over a predetermined area of the windscreen.

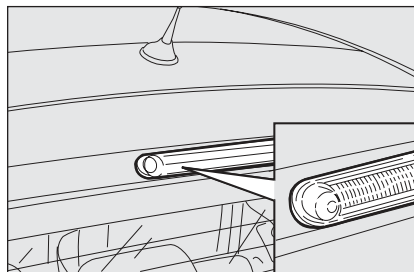

fig. 19

Rear window washer fig. 19

The rear window nozzle do not need to be adjusted. The liquid is atomised over a predetermined area of the rear window.

The nozzle is arranged on the upper part of the tailgate.

BODYWORK

PROTECTION FROM ATMOSPHERIC AGENTS

The main causes of corrosion are the following:

- atmospheric pollution;
- salty air and humidity (coastal areas, or hot humid climates);
- seasonal environment conditions.

Not to be underestimated is also the abrasive action of wind-borne atmospheric dust and sand and mud and gravel raised by other cars.

On your vehicle, Lancia has implemented the best manufacturing technologies to effectively protect the bodywork against corrosion.

These include:

- ❑ painting products and systems which give the car particular resistance to corrosion and abrasion;
- ❑ use of galvanised (or pretreated) steel sheets, with high resistance to corrosion;
- ❑ spraying of plastic parts with a protective function in the more exposed points: under door, inner wing parts, edges, etc.;
- ❑ boxed parts are designed to prevent condensation and pooling of water which can cause corrosion from the inside.

BODY AND UNDERBODY WARRANTY

Your car is covered by warranty against perforation due to rust of any original element of the structure or body. For the general terms of this warranty, refer to Lancia Warranty Booklet.

ADVICE FOR PRESERVING THE BODYWORK

Paint

Paintwork does not only serve an aesthetic purpose, but also protects the underlying sheet metal.

Touch up abrasions and scratches immediately to prevent the formation of rust. Only use genuine spare paint products for touch-ups (see “Bodywork paint identification plate” in the “Technical Specifications” section).

Normal maintenance of paintwork consists in washing the car: the frequency depends on the conditions and environment where the car is used. For example, it is advisable to wash the car more often in areas with a high environmental pollution or on roads sprinkled with salt.

DASHBOARD
AND
CONTROLS

SAFETY

STARTING
AND DRIVING

WARNING
LIGHTS AND
MESSAGES

IN AN
EMERGENCY

MAINTENANCE
AND CARE

TECHNICAL
SPECIFICA-
TIONS

INDEX

To correctly wash the car:

- remove the aerial from the roof to prevent damage to it if the car is washed in an automatic system;
- wash the body using a low pressure jet of water;
- wipe a sponge with a slightly soapy solution over the bodywork, frequently rinsing with the sponge;
- rinse well with water and dry with a jet of air or a chamois leather.

Dry the parts less in sight particularly carefully, such as the door frames and the headlight frames, where water may stagnate more easily. It is a good idea to leave the car in the open for a while after washing it to give time for the water to evaporate.

Do not wash the car after it has been parked in the sun or when the engine is bonnet is hot: this could take the shine off the paint.

Exterior plastic parts must be cleaned in the same way as the rest of the car.

Where possible, do not park under trees; the resinous substance many species release give the paint a dull appearance and increase the possibility of triggering rust processes.

IMPORTANT Bird droppings must be washed off immediately and thoroughly as the acid they contain is particularly aggressive.



Detergents pollute the environment. The vehicle should be washed in areas equipped for collecting and purifying the liquid used in the washing process.

Windows

Use specific window cleaner products. Also use clean cloths to avoid scratching the glass or damaging the transparency.

IMPORTANT Wipe the rear window inside gently with a cloth in the direction of the filaments to avoid damaging the heating device.

Front headlights

IMPORTANT Never use aromatic substances (e.g.: petrol) or ketenes (e.g.: acetone) for cleaning front headlight plastic lens.

Engine compartment

At the end of every winter, wash the engine compartment thoroughly, taking care not to aim the jet of water directly at the electronic control units or at the windscreen wiper motors. Have this operation performed at a specialised workshop.

IMPORTANT Perform this operation on a cold engine and with the key at **STOP**. After the washing operation, make sure that the various protections (e.g. rubber caps and guards) have not removed or damaged.



WARNING

Never use flammable products, such as petrol ether or rectified petrol to clean inside the car. The electrostatic charges which are generated by rubbing during the cleaning operation may cause a fire.

INTERIORS

Periodically check that water is not trapped under the mats (due to water dripping off shoes, umbrellas, etc.) which could cause oxidation of the sheet metal.

CLEANING SEATS AND FABRIC PARTS

Remove dust with a soft brush or a vacuum cleaner. It is advisable to use a moist brush on velvet upholstery. Rub the seats with a sponge moistened with a solution of water and neutral detergent.

INTERIOR PLASTIC PARTS

It is advisable to clean interior parts with a moist cloth and a solution of water and mild soap. Use specific products for cleaning plastic, without solvents and specifically designed to prevent damage to the appearance and colour of the treated parts to remove grease and tough stains.

IMPORTANT Never use spirit or petroleum to clean the instrument panel.

DASHBOARD
AND
CONTROLS

SAFETY

STARTING
AND DRIVING

WARNING
LIGHTS AND
MESSAGES

IN AN
EMERGENCY

MAINTENANCE
AND CARE

TECHNICAL
SPECIFICA-
TIONS

INDEX

LEATHER STEERING WHEEL/GEAR KNOB

These components must be cleaned with mild soap and water only. Never use spirit and/or alcohol based products.

Read the product label carefully before using specific products for cleaning the interiors: make sure the product does not contain alcohol or alcohol based substances.

If window cleaner accidentally drips onto the steering wheel or gear lever knob, wipe away immediately and then wash the concerned area with mild soap and water.

IMPORTANT Be careful when arranging a steering wheel lock device, where applicable, to prevent damaging the leather upholstery by rubbing.



WARNING

Do not keep aerosol cans in the car: risk of explosion. Aerosol cans must not be exposed to a temperature exceeding 50°C. When the vehicle is exposed to sunlight, inner temperature can greatly exceed this value.

TECHNICAL SPECIFICATIONS

IDENTIFICATION DATA	188
ENGINE CODES - BODYWORK VERSIONS	190
ENGINE	191
FUEL FEED	192
TRANSMISSION	192
BRAKES	193
SUSPENSIONS	193
STEERING SYSTEM	193
WHEELS	194
DIMENSIONS	198
PERFORMANCE	199
WEIGHTS	200
CAPACITIES	201
FLUIDS AND LUBRICANTS	202
FUEL CONSUMPTION	204
CO ₂ EMISSIONS	205

DASHBOARD
AND
CONTROLS

SAFETY

STARTING
AND DRIVING

WARNING
LIGHTS AND
MESSAGES

IN AN
EMERGENCY

MAINTENANCE
AND CARE

TECHNICAL
SPECIFICA-
TIONS

INDEX

IDENTIFICATION DATA

Take note of the identification codes. The identification data are printed on labels **fig. 1** in the following positions:

- 1 - Model plate
- 2 - Chassis marking.
- 3 - Bodywork paint identification plate.
- 4 - Engine marking.

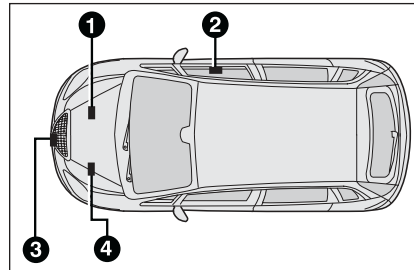

fig. 1

LOD0450m

MODEL PLATE **fig. 2**

This plate is fitted to the engine compartment front crossmember and contains the following data:

- B** - Type approval number.
- C** - Vehicle type code.
- D** - Chassis number.
- E** - Maximum vehicle weight fully loaded.
- F** - Maximum vehicle weight fully loaded with trailer.

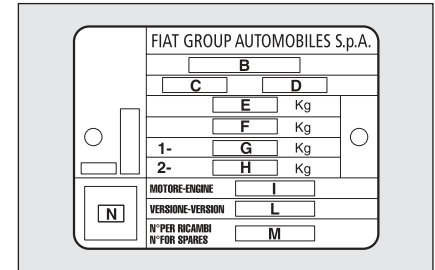

fig. 2

LOD0415m

G - Maximum vehicle weight on front axle.

H - Maximum vehicle weight on rear axle.

I - Engine type.

L - Body version code.

M - Spare part code.

N - Smoke opacity index (for diesel engines).

CHASSIS MARKING fig. 3

This is printed on the passenger compartment floor bed near the front right seat.

The label can be accessed by lifting the window in the mat and comprises:

- vehicle model;
- the chassis progressive number.

BODYWORK PAINT IDENTIFICATION PLATE fig. 4

This plate is applied to the bonnet and shows the following data:

- A - Paint manufacturer.
- B - Colour name.
- C - Lancia colour code.
- D - Respray and touch up code.

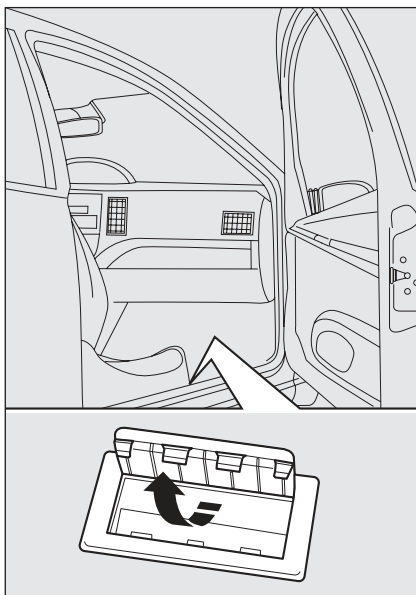

fig. 3

L0D0227m

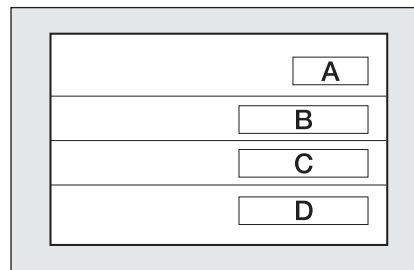

fig. 4

L0D0228m

ENGINE MARKING

It is stamped onto the cylinder block (passenger compartment side) and shows the type and the serial number.

DASHBOARD
AND
CONTROLS

SAFETY

STARTING
AND DRIVING

WARNING
LIGHTS AND
MESSAGES

IN AN
EMERGENCY

MAINTENANCE
AND CARE

TECHNICAL
SPECIFICA-
TIONS

INDEX

ENGINE CODES - BODYWORK VERSIONS

Versions	Engine type code	Bodywork code
1.4 8v (▲)	350A1000	350 AXF1A08 VL (5 seats) (○)
1.4 16V	843A1000	350 AXA1B 07RL (5 seats) (□)
1.4 16v 90 HP (▲)	192B2000	350 AXE1A06EL (5 seats) (○)
1.3 Multijet 70 HP	188A9000	350 AXB1A01UL (5 seats) (○)
1.3 Multijet 90 HP	199A3000	350 AXG1A09ASL (5 seats) (○) 350 AXC1A09ATL (5 seats) (*) (○)
1.3 Multijet 95 HP	199B1000	350AXM1A 13DL (5 seats) (*) (□)
1.6 Multijet	350A2000	350 AXH1A 11PL (5 seats) (*) (○) 350 AXH1A 11RL (5 seats) (*) (□)
1.6 Multijet 115 HP (▲)	350A3000	350 AXL1A12 PL (5 seats) (*) (○) 350 AXL1A12 RL (5 seats) (*) (□)

(▲) Engine version for some versions/markets only

(*) DPF version

(○) EURO 4

(□) EURO 5

ENGINE

		1.48v (▲)	1.416v	1.3 Multijet 70 HP	1.3 Multijet 90 HP	1.3 Multijet 95 HP	1.6 Multijet
INTRODUCTION							
Type code:		350A1000	843A1000	188A9000	199A3000	199B1000	350A2000
Cycle:		Otto	Otto	Diesel	Diesel	Diesel	Diesel
Cylinder number and position:		4 in line	4 in line	4 in line	4 in line	4 in line	4 in line
Number of valves per cylinder:		2	4	4	4	4	4
Piston bore and stroke	mm	72 x 84	72 x 84	69.6 x 82	69.6 x 82	69.6 x 82	79.5 x 80.5
Total displacement	cm ³	1368	1368	1248	1248	1248	1598
Compression ratio		11±0,2	11±0,2	18±0.4	17,6±0,4	16,8 + 0.2/- 0.4	16,5±1
Max. EEC power	kW	57	70	51	66	70	88
	HP	77	95	70	90	95	120
corresponding rpm:	rpm	6000	5800	4000	4000	4000	3500
Max. EEC torque	Nm	115	128	180	200	200	300
	kgm	11,7	13	18,3	20	20	30,5
corresponding rpm:	rpm	3000	4500	1750	1750	1500	1500
Spark plugs:		NGK ZKR7A-10	NGK ZKR7A-10	—	—	—	—
Fuel:		Unleaded petrol 95 RON (EN228 specifications)	Unleaded petrol 95 RON (EN228 specifications)	Diesel fuel for motor vehicles (EN590 specifications)	Diesel fuel for motor vehicles (EN590 specifications)	Diesel fuel for motor vehicles (EN590 specifications)	Diesel fuel for motor vehicles (EN590 specifications)

(▲) Engine version for some versions/markets only

DASHBOARD
AND
CONTROLS

SAFETY

STARTING
AND DRIVING

WARNING
LIGHTS AND
MESSAGES

IN AN
EMERGENCY

MAINTENANCE
AND CARE

TECHNICAL
SPECIFICATIONS

INDEX

FUEL FEED

	1.48v (▲) - 1.416v	1.3 Multijet - 1.6 Multijet
Fuelfeed	Multipoint sequential phased injection, integrated with ignition, returnless system	Common Rail Multijet direct injection electronically controlled with turbo and intercooler

TRANSMISSION

	1.48v (▲) - 1.3 Multijet - 1.6 Multijet	1.416v
Gearbox	Five forward gears plus reverse with synchronisers for forward gears	Five forward gears plus reverse with synchronisers for forward gears
Clutch	Hydraulic control and play-less pedal	Hydraulic control and play-less pedal
Traction	Front	Front



Modifications or repairs to the fuel feed system that are not carried out properly or do not take the system's technical specifications into account can cause malfunctions leading to the risk of fire.

(▲) Engine version for some versions/markets only

BRAKES

	1.48v (▲) - 1.416v - 1.3 Multijet 70 HP	1.3 Multijet 90 HP - 1.3 Multijet 95 HP 1.6 Multijet
Service brakes:		
– front	Self-ventilating discs (257 mm x 22 mm)	Self-ventilating discs (284 mm x 22 mm)
– rear	Drum (203 mm x 38 mm)	1.3 Multijet 90 HP -1.3 Multijet 95 HP: drum (228 mm x 40 mm) 1.6 Multijet: disc (240 mm x 11 mm)
Parking brake	Operated by hand lever, acting on rear brakes	Operated by hand lever, acting on rear brakes

IMPORTANT Water, ice and salt sprinkled on the roads may deposit on the brake disks reducing braking efficiency the first time the brakes are applied.

(▲) Engine version for some versions/markets only

SUSPENSIONS

	1.48v (▲) - 1.416v - 1.3 Multijet - 1.6 Multijet
Front	McPherson independent wheels
Rear	Semi-independent wheels interconnected by means of torque axle

(▲) Engine version for some versions/markets only

STEERING SYSTEM

	1.48v (▲) - 1.416v - 1.3 Multijet - 1.6 Multijet
Type	Rack and pinion with electric power steering
Steering circle (kerb to kerb)	m 10,0

(▲) Engine version for some versions/markets only

DASHBOARD
AND
CONTROLS

SAFETY

STARTING
AND DRIVING

WARNING
LIGHTS AND
MESSAGES

IN AN
EMERGENCY

MAINTENANCE
AND CARE

TECHNICAL
SPECIFICATIONS

INDEX

WHEELS

RIMS AND TYRES fig. 5

Pressed steel or alloy rims. Tubeless radial carcass tyres. All approved tyres are listed in the Log Book.

IMPORTANT In the event of discrepancies between the information provided on this “Owner’s handbook” and the “Log book”, consider the specifications shown in the log book only.

Respect the prescribed size to ensure safety of the car in movement. Fit tyres of the same make and type on all wheels.

IMPORTANT Do not use inner tubes with Tubeless tyres.

SPACE SAVER SPARE WHEEL

Pressed steel rim Tubeless tyre.

WHEEL GEOMETRY

Front wheel toe-in measured between rims: 0 ± 1 mm.

The values refer to the car in running order.

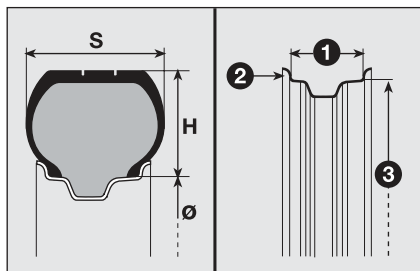

fig. 5

L0D0229m

HOW TO READ TYRE DATA

Example: 185/65 R 14 86 T

185 = Nominal width (S, distance in mm between sidewalls).

65 = Percentage height/width ratio (H/ S).

R = Radial tyre.

14 = Rim diameter in inches (Ø).

86 = Load rate (capacity).

T = Maximum speed rating.



fig. 6

L0D0502m

RIM PROTECTOR TYRES fig. 6



WARNING

If after-sale tyres with rim protector are used (fig. 6) and the car has integral caps fixed (by springs) to the sheet wheel, DO NOT fit wheel caps. The use of unsuitable tyres and wheel caps could cause a sudden pressure loss of the tyre.

Load rating (capacity)

60 = 250 kg	84 = 500 kg
61 = 257 kg	85 = 515 kg
62 = 265 kg	86 = 530 kg
63 = 272 kg	87 = 545 kg
64 = 280 kg	88 = 560 kg
65 = 290 kg	89 = 580 kg
66 = 300 kg	90 = 600 kg
67 = 307 kg	91 = 615 kg
68 = 315 kg	92 = 630 kg
69 = 325 kg	93 = 650 kg
70 = 335 kg	94 = 670 kg
71 = 345 kg	95 = 690 kg
72 = 355 kg	96 = 710 kg
73 = 365 kg	97 = 730 kg
74 = 375 kg	98 = 750 kg
75 = 387 kg	99 = 775 kg
76 = 400 kg	100 = 800 kg
77 = 412 kg	101 = 825 kg
78 = 425 kg	102 = 850 kg
79 = 437 kg	103 = 875 kg
80 = 450 kg	104 = 900 kg
81 = 462 kg	105 = 925 kg
82 = 475 kg	106 = 950 kg
83 = 487 kg	

Maximum speed rating

Q = up to 160 km/h.
R = up to 170 km/h.
S = up to 180 km/h.
T = up to 190 km/h.
U = up to 200 km/h.
H = up to 210 km/h.
V = up to 240 km/h.
W = up to 270 km/h.
Y = up to 300 km/h.

HOW TO READ THE RIM DATA

Example: **6 J x 14 ET 40**

- 6** = rim diameter in inches (1).
- J** = rim drop centre outline (side projection where the tyre bead rests) (2).
- 14** = rim nominal diameter in inches (corresponds to diameter of the tyre to be mounted) (3 = Ø).
- ET** = shape and number of humps (used for withholding tubeless tyre beads on the rim).
- 40** = wheel camber angle (distance between the disc/rim supporting plane and the wheel rim centre line).

RIMS AND TYRES

VERSIONS	RIMS	TYRES		SPACE SAVER SPARE	
		Provided	Winter	Rim	Tyre
1.4 petrol - 1.3 Multijet 70 HP	6 Jx14" ET 40	185/65 R14 86T	185/65 R14 86Q (M+S)	4Bx14" (***)	135/80 B14 84M (***)
	6 Jx15" ET 40 (*)	195/60 R15 88H	195/60 R15 88Q (M+S)	alternatively	
	6 1/2 Jx16" ET 40 (alloy)	205/50 R16 87V (**)	-	4Bx15"	125/80 R15 95M (***)
1.3 Multijet 90 HP	6Jx15" ET 40 (*)	195/60 R15 88H	195/60 R15 88Q (M+S)	4Bx15"	125/80 R15 95M
1.3 Multijet 95 HP					
1.6 Multijet	6 1/2 Jx16" ET 40 (alloy)	205/50 R16 87V (**)	-		

(*) Optional alloy rim

(**) Tyres to which chains cannot be fitted

(***) **IMPORTANT** The 14" space saver spare wheel can only be used on 1.4 petrol and 1.3 Multijet 70HP versions **with chassis number higher than 1012200**.

COLD TYRE INFLATION PRESSURES (bar)

Tyre size	TYRES PROVIDED			
	Medium load		Full load	
	Front	Rear	Front	Rear
185/65 R14 86T	2.2	2.1	2.3	2.3
195/60 R15 88T	2.2	2.1	2.3 (2.4 ▲)	2.3
205/50 R16 87V	2.2	2.1	2.3 (2.5 ▲)	2.3
▲ 1.6 Multijet versions only				
SPACE SAVER SPARE WHEEL	135/80 B14 84M		2.8	
	125/80 R15 95M		4.2	

Add +0.3 bar to the prescribed inflation pressure when the tyres are warm. Recheck pressure value with cold tyres.

With snow tyres, add +0.2 bar to the inflation pressure value prescribed for standard tyres.

DIMENSIONS

Dimensions are expressed in mm and refer to the vehicle equipped with its original tyres.

The height refers to the unladen vehicle.

Luggage compartment volume

Capacity with vehicle unladen
(V.D.A. standards): 390 dm³

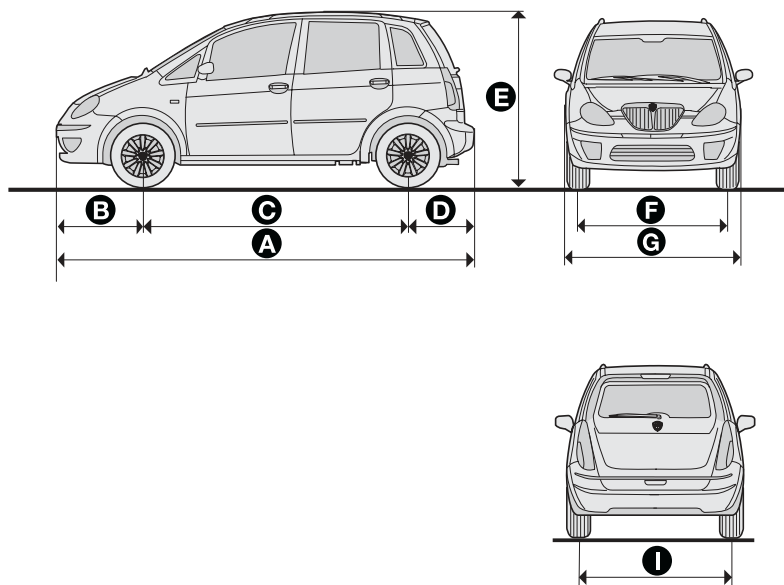

fig. 7

L0D0451m

A	B	C	D	E	F (*)	G	I
4035	848	2508	679	1660	1444	1698	1431

(*) Minor variations in size are possible depending on the dimensions of the rims

PERFORMANCE

With mechanical gearbox

Top permissible speed after initial car use in km/h.

1.48v (▲)	1.416v	1.3 Multijet 70HP	1.3 Multijet 90HP	1.3 Multijet 95HP	1.6 Multijet
163	175	159	173	175	190

(▲) Engine version for some versions/markets only

DASHBOARD
AND
CONTROLS

SAFETY

STARTING
AND DRIVING

WARNING
LIGHTS AND
MESSAGES

IN AN
EMERGENCY

MAINTENANCE
AND CARE

TECHNICAL
SPECIFICA-
TIONS

INDEX

WEIGHTS

Weights (kg)

1.48V (▲) - 1.416V

1.3 Multijet

1.6 Multijet

Unladen weight (with all liquids,
fuel tank filled to 90 % and
without optional equipment):

1155

1200

1275

Payload (*)
including the driver:

500

500

500

Maximum permissible loads
(**)

– front axle:

940

940

1000

– rear axle:

805

805

805

– total:

1655

1700

1775

Towable loads:

– trailer with brakes:

1000

1000

1100

– trailer without brakes:

400

400

500

Maximum load on roof:

75

75

75

Maximum load on tow hitch
(trailer with brakes):

60

60

60

(*) If special equipment is fitted (sun roof, tow hook, etc.) the unladen weight increases and consequently the payload will decrease in relation to the maximum permitted loads.

(**) Loads not to be exceeded. The driver is responsible for arranging goods in the luggage compartment and/on load carrying platform within the maximum permitted loads.

(▲) Engine version for some versions/markets only

CAPACITIES

	1.48v (▲)		1.416v		1.3 Multijet		1.6 Multijet		Recommended fuels Genuine products
	litres	kg	litres	kg	litres	kg	litres	kg	
Fuel tank: including a reserve of:	47 5 - 7	- -	47 5 - 7	- -	- -	- -	- -	- -	Unleaded petrol with no less than 95 R.O.N. (EN 228 Specification)
Fuel tank: including a reserve of:	- -	- -	- -	- -	47 5 - 7	- -	47 5 - 7	- -	Diesel fuel for motor vehicles (EN590 specifications)
Engine cooling system:	4.5	-	4.5	-	6.0	-	7.8	-	50% mixture of demineralized water and PARAFLU^{UP} (□)
Engine sump: Engine sump and filter:	2.4 2.6	2.1 2.25	2.5 2.7	2.2 2.35	- -	- -	- -	- -	SELENIA K P.E.
Engine sump: Engine sump and filter:	- -	- -	- -	- -	2.85 3.0	2.54 2.65	4.4 4.7	3.74 4.0	SELENIA WR P.E.
Gearbox/differential casing:	1.65	1.5	1.65	1.5	1.98	1.8	-	1.6	TUTELA CAR TECHNIX
Hydraulic brake circuit:	0.45	-	0.45	-	0.45	-	0.45	-	TUTELA TOP 4
Windscreen/rear window washer fluid reservoir:	1.5	-	1.5	-	1.5	-	1.5	-	Mixture of water and TUTELA PROFESSIONAL SC35

(▲) Engine version for some versions/markets only

(□) When the vehicle is used under particularly harsh climate conditions, we recommend using a mix of 60% **PARAFLU^{UP}** and 40% demineralised water.

DASHBOARD
AND
CONTROLS

SAFETY

STARTING
AND DRIVING

WARNING
LIGHTS AND
MESSAGES

IN AN
EMERGENCY

MAINTENANCE
AND CARE

TECHNICAL
SPECIFICATIONS

INDEX

FLUIDS AND LUBRICANTS

RECOMMENDED PRODUCTS AND SPECIFICATIONS

Use	Fluid and lubricant features for correct car operation	Genuine fluids and lubricants	Replacement procedures
Engine lubricants petrol	Synthetic base lubricants SAE 5W-40 ACEA C3 grade. Qualification FIAT 9.55535-S2.	SELENIA K P.E. Contractual Technical Reference No. F603.C07	According to Service Schedule
Lubricants for diesel engines	Synthetic base lubricants SAE 5W- 30 grade. Qualification FIAT 9.55535-S1.	SELENIA WR P.E. Contractual Technical Reference No. F510.D07	According to Service Schedule

For diesel engines, in the event of an emergency in which the original products are not available, lubricants with at least ACEA C2 performance are acceptable; however, in this case optimum engine performance is not guaranteed and the lubricant should be replaced as soon as possible at a Lancia Dealership.

The use of products with features lower than ACEA A3 and ACEA C2 could cause engine damage not covered by warranty.

Use	Fluid and lubricant features for correct car operation	Genuine fluids and lubricants	Applications
Motion transmission lubricants and grease	All synthetic lubricant SAE 75W-85 grade. Exceeding API GL-4 PLUS, FIAT 9.55550 MIL-L- 2105 D LEV specifications. Classification FIAT 9.55550-MX3	TUTELA CAR TECHNIX Contractual Technical Reference N° F010.B05	Gearbox and differentials (mechanical)
	Molybdenum disulphide grease for high temperatures. Consistency NLGI 1-2 Classification FIAT 9.55580	TUTELA ALL STAR Contractual Technical Reference N° F702.G07	CV joint wheel side
	Polyurea base synthetic grease for high temperatures. Consistency NLGI 2 Classification FIAT 9.55580	TUTELA STAR 325 Contractual Technical Reference N° F301.D03	CV joints on differential side subject to high temperatures (1.416V versions)
	Specific grease for low-friction coefficient CV joints. Consistency NLGI 0-1 Classification FIAT 9.55580	TUTELA STAR 700 Contractual Technical Reference N° F701.C07	CV joints differential side
Brake liquid	Synthetic fluid, F.M.V.S.S. n.116, DOT 4, ISO 4925, SAE J-1704, CUNA NC 956-01 Classification FIAT 9.55597	TUTELA TOP 4 Contractual Technical Reference N° F001.A93	Hydraulic brake and clutch
Radiator protection	Red protective with antifreeze action, based on inhibited monoethylene glycol with organic formula based on O.A.T, that passes CUNA NO 956-16, ASTM D 3306 specifications Classification FIAT 9.55523	PARAFLU^{UP} (●) Contractual Technical Reference N° F101.M01	Cooling circuit. Percentage of use 50% to -35° C. Do not mix with product of different type(□)
Additive for diesel fuel	Additive for diesel fuel, protecting Diesel engines	TUTELA DIESEL ART Contractual Technical Reference N° F601.L06	To be mixed with fuel oil (25 cc per 10 litres)
Windscreen/rear window washer fluid	Mixture of alcohol and surfactants CUNA NC 956-11 Classification FIAT 9.55522	TUTELA PROFESSIONAL SC35 Contractual Technical Reference N° F201.D02	To be used diluted or undiluted in windscreen/rear window washer/wiper systems

(●) **IMPORTANT** Do not use fluids with different specifications for topping up or mixing.

(□) When the vehicle is used under particularly harsh climate conditions, we recommend using a 60% mixture of **PARAFLU^{UP}** and demineralised water.

DASHBOARD AND CONTROLS

SAFETY

STARTING AND DRIVING

WARNING LIGHTS AND MESSAGES

IN AN EMERGENCY

MAINTENANCE AND CARE

TECHNICAL SPECIFICATIONS

INDEX

FUEL CONSUMPTION

The fuel consumption figures given in the table below are determined on the basis of the homologation tests laid down by specific European Directives.

The procedures below are followed for measuring consumption:

- urban cycle: cold starting followed by driving that simulates urban use of the car;
- extra urban cycle: driving simulating the use of the vehicle in a non-urban situation with frequent acceleration in all gears; the speed varies between 0 and 120 km/h;
- combined consumption: calculated weighing about 37% of urban cycle consumption and about 63% of extra urban consumption.

IMPORTANT The type of route, traffic situations, weather conditions, driving style, general conditions of the car, trim level/equipment/accessories, load, climate control system, roof rack, other situations that affect air drag may lead to different fuel consumption levels than those measured.

According to European Directive in force
(litres/100 km)

	Urban	Extra urban	Combined
1.48V (▲)	7.9	5.1	6.1
1.416V (5 gears)	8.5	5.5	6.6
1.416V (6 gears)	8.5	4.8	6.2
1.3 Multijet 70 HP	5.8	4.1	4.7
1.3 Multijet 90 HP	5.8	3.9	4.6
1.3 Multijet 95 HP	5.7	3.8	4.5
1.6 Multijet	6.0	4.0	4.7

(▲) Engine version for some versions/markets only

CO₂ EMISSIONS

The CO₂ emission figures in the table below refer to combined fuel consumption.

CO₂ EMISSIONS ACCORDING TO EUROPEAN DIRECTIVE IN FORCE (g/km)

1.48v (▲)	5 gears	6 gears
145	157	146

(▲) Engine version for some versions/markets only

1.3 Multijet 70HP	1.3 Multijet 90HP	1.3 Multijet 95HP	1.6 Multijet
125	120	118	124

DASHBOARD
AND
CONTROLS

SAFETY

STARTING
AND DRIVING

WARNING
LIGHTS AND
MESSAGES

IN AN
EMERGENCY

MAINTENANCE
AND CARE

TECHNICAL
SPECIFICA-
TIONS

INDEX

ARRANGEMENTS FOR DEALING WITH THE CAR AT THE END OF ITS LIFE

Lancia has been committed for many years to safeguarding the environment through the constant improvement of its production processes and manufacturing products that are increasingly compatible with the ecosystem. To assure customers of the best possible service in terms of respecting environmental laws and in response to European Directive 2000/53/EC governing vehicles at the end of their life, Lancia is offering their customers the opportunity of handing over their vehicle* at the end of its life without incurring any additional costs.

The European Directive sets out that when the vehicle is handed over the last keeper or owner should not incur any expenses as a result of its market value. In particular, in all European Union countries, until 1st January 2007, vehicles registered after 1st July 2002 will be collected free of charge, whilst from 2007 collection will be free of charge irrespective of the year of registration as long as the vehicle contains its basic components (in particular, the engine and bodywork) and has no additional waste.

To hand your vehicle over at the end of its life without extra cost, go to one of our Lancia dealerships or authorized collection and scrapping centres. These centres have been carefully chosen to offer high quality service for the collection, treatment and recycling of unused vehicles with respect to the environment.

You can find further information on these collection and scrapping centres either from a Lancia Dealership or by calling the freephone number 00800 526242 00 or on the Lancia website.

* Vehicle for transporting passengers with a maximum of nine seats with a total permitted weight of 3.5 t

SELENIA®

In the heart of your engine.



Always ask your mechanic for **SELENIA®**

Oil change? The experts recommend Selenia

*The engine of your car is factory filled with **Selenia**. This is an engine oil range which satisfies the most advanced international specifications. Its superior technical characteristics allow **Selenia** to guarantee the **highest performance and protection of your engine.***

The Selenia range includes a number of technologically advanced products:

SELENIA K PURE ENERGY

Synthetic lubricant designed for latest generation, low emission, petrol engines. Its specific formulation warrants the utmost protection also for high performance turbocharged engines with high thermal stress. Its low ash content helps to maintain the total cleanliness of modern catalysis.

SELENIA WR PURE ENERGY

Fully synthetic lubricant that can meet the requirements of the latest diesel engines. Low ash content to protect the particulate filter from the residual products of combustion. High Fuel Economy System that allows considerable fuel saving. It reduces the danger of dirtying the turbine to ensure the protection of increasingly high performance diesel engines

SELENIA MULTIPower

Particularly ideal for the protection of new generation petrol engines, very effective even in the most severe weather conditions. It guarantees a reduction in fuel consumption (Energy conserving) and it is also ideal for alternative engines.

SELENIA SPORT

Fully synthetic lubricant capable of meeting the needs of high performance engines. Studied to protect the engine also in high thermal stress conditions, it prevents deposits on the turbine to achieve the utmost performance in total safety.

The range also includes Selenia StAR Pure Energy, Selenia Racing, Selenia K, Selenia WR, Selenia 20K, Selenia 20K AR. For further information on Selenia products visit the web site www.selenia.com.

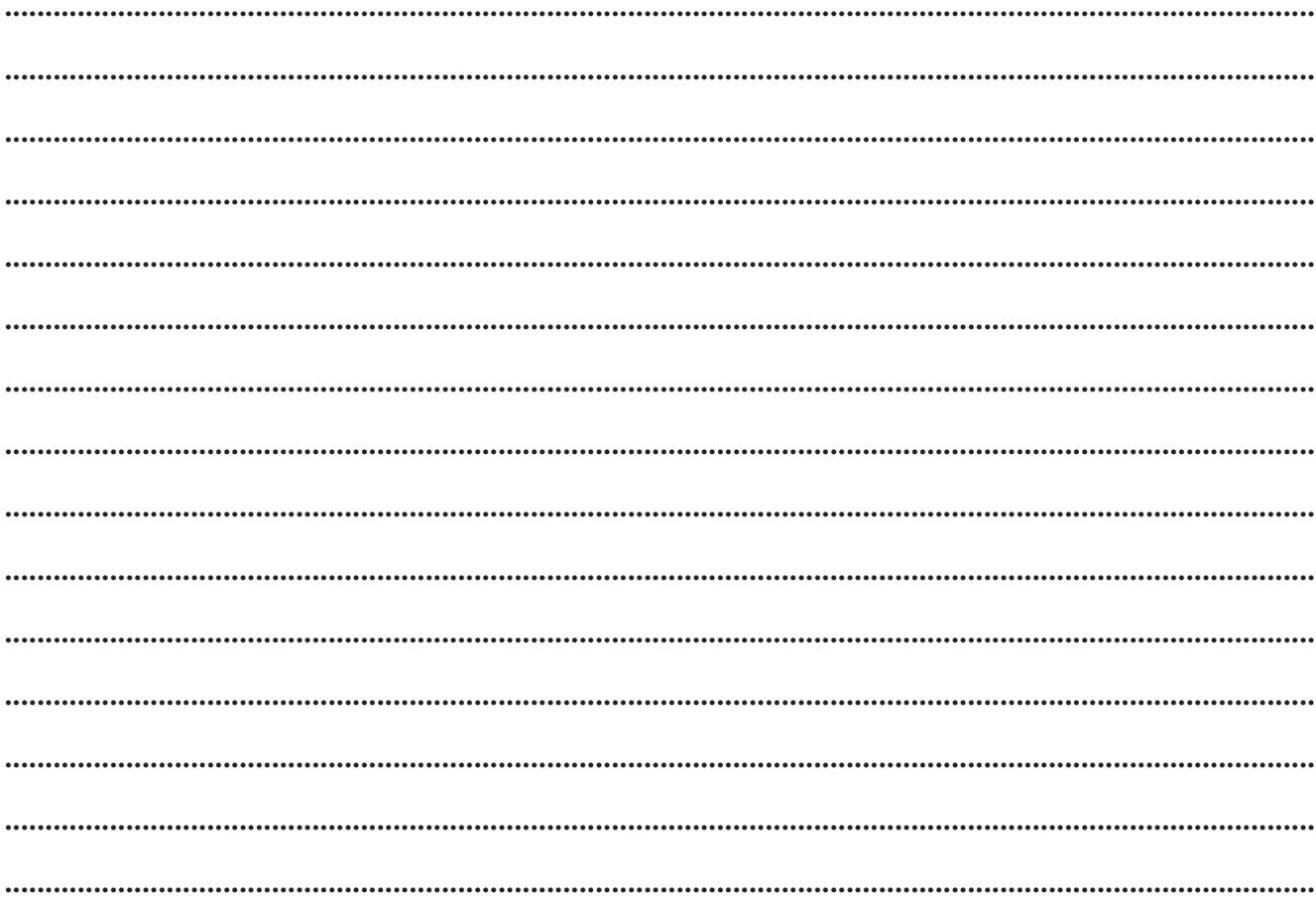

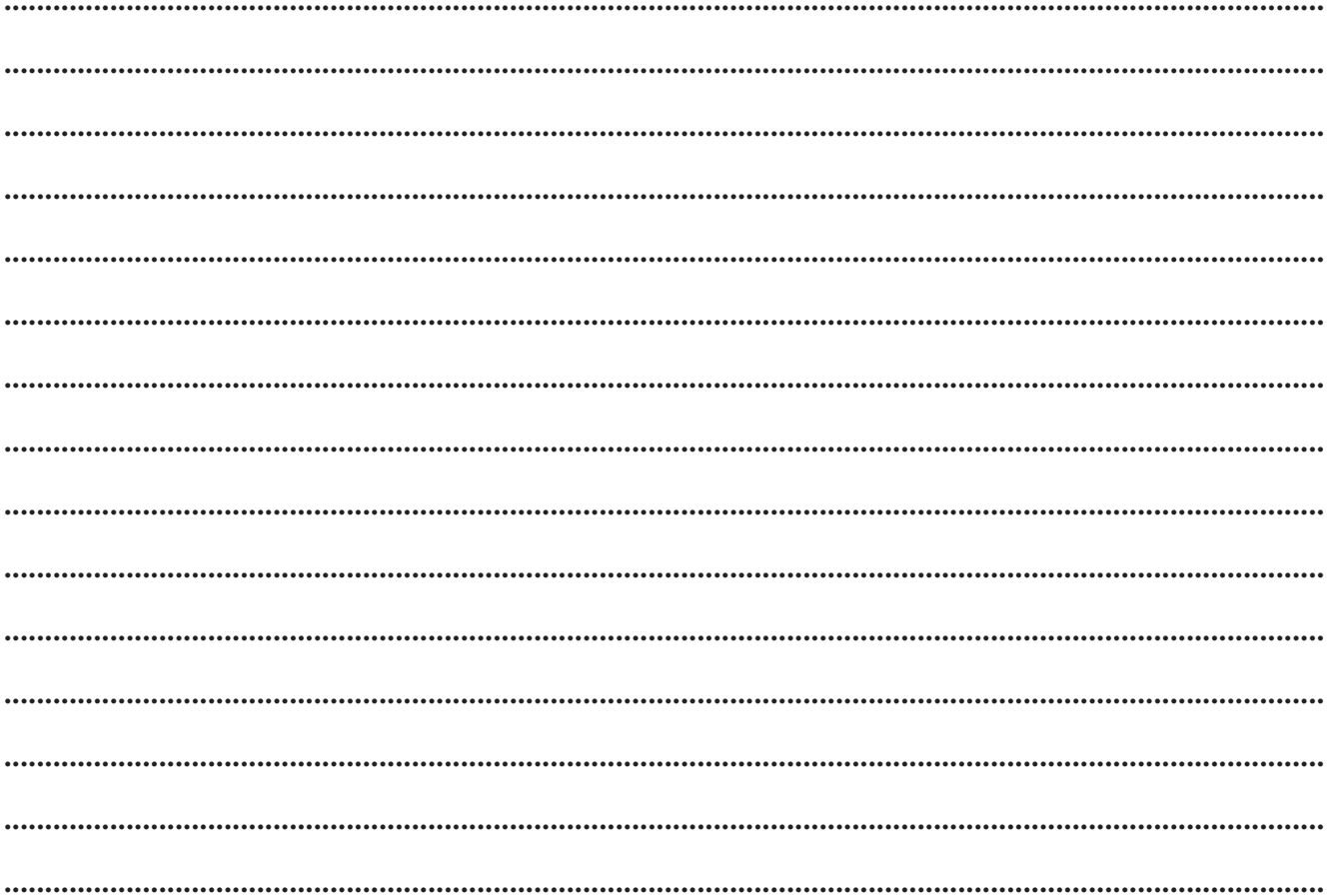

INDEX

DASHBOARD AND CONTROLS	ABS (System)	85	Brakes	Dashboard	8
SAFETY	Accessories purchased by the owner	88	- fluid level	Dashboard and controls	7
	Air vents	48	- handbrake	Dimensions	198
STARTING AND DRIVING	Ashtray (smoker's kit)	75	- technical data	Dipped beam headlights	
	Automatic dual-zone climate system.....	52	Bulb (replacement)	- bulb replacement	151
WARNING LIGHTS AND MESSAGES	Battery		Capacities	- controls	62
	- checking battery charge and liquid level (electrolyte).....	177	Car maintenance and care	Direction indicators	63
IN AN EMERGENCY	- jump starting	137	- scheduled maintenance plan	Direction indicators	
	- replacement	178	Car parked	- bulb replacement	152
MAINTENANCE AND CARE	Bodywork		Car radio	- controls	63
	- maintenance	182	- setup	Dualdrive	
TECHNICAL SPECIFICATIONS	- version codes	190	Carrying children safely	(electric power steering)	89
	Bonnet	82	Ceiling light	Engine compartment	171
INDEX	Boot	80	Changing a wheel	Engine coolant gauge	22
	Boot extension	80	Checking fluid levels	Engine cooling system fluid level	174
	Brake fluid level	176	Child lock	Engine oil level	173
	Brake lights		Cigar lighter (smoker's kit)	Engine oil	
	- bulb replacement	153	Clutch	- level check	173
			CO ₂ emissions	- technical specifications	202
			Control buttons display.....		
			22-25		
			Cruise Control		
			67		

Engine		Fuel		- CD holder compartment with can holder.....	75
- cranking	20	- consumption.....	204	- cup/can holder	74
- features	191	- fuel gauge	21	- current socket.....	75
- power supply	192	- inertia fuel switch	72	- glove compartment.....	73
- identification code	188	Fuses	156	- oddment compartments (upper).....	73
Environment protection	94	Gearbox (use)	117	- oddment shelf on roof.....	74
EOBD (system)	86	GSI system.....	87	Isofix child seat	105
Exterior lights	62	Hazard warning lights		Jack	144
Fire protection system (FPS)..	72	- controls	71	Key and door locking kit.....	13
Fix&GO Automatic (quick tyre repair kit)	138	Head restraints	44	Lancia CODE system	11
Fluids and lubricants	202	Headlamp alignment corrector	84	Levels	
Fog lights		Headlight beam corrector (electric corrector)	84	- checking	171
- bulb replacement	153	Headlights	84	Lubricants (features)	202
- control buttons	71	Identification data	188	Main beam headlights	
FPS (Fire Protection System)	72	Ignition switch	20	- bulb replacement	151
Front air bags	108	In an emergency	135	- controls	62
- driver's front airbag.....	108	Instrument panel	10	Manual climate control	48
- front airbag passenger side	109	Interior	185	Mechanical Brake Assist.....	85
- manually deactivating the passenger front and side airbag	110	Interior equipment			
Fuel cap	92	- card holder	74		

Multifunctional display22-25	- fluid level 175	- bulb replacement 152
Number plate light	Rear window wiper	- controls 62
- bulb replacement 154	- blades 181	Snow chains 123
Oddment compartments (upper) 73	- controls 64	Spark plugs 191
On board instruments 21	- nozzles..... 182	Speedometer 21
Parking sensors 90	Rev counters 21	Starting the engine
Performance 199	Reversing light	- bump starting..... 138
Plates 188	- bulb replacement 154	- ignition switch 20
Power socket..... 75	Rim Protector 194	- jump starting 137
Power windows 78	Rims and wheels 194	- procedure for petrol versions 114
Protecting the environment ... 94	Roof bars 83	- procedure for Multijet
Radiotransmitters	Rubber hoses 180	versions 114
and mobile phones 89	Safety 95	- stopping the engine..... 115
Rain sensor 65	Seat belts	- warming up the engine once
Raising the vehicle 161	- general information 100	started 115
Rear fog light	- height adjustment 97	Starting up and driving 113
- bulb replacement 154	- maintenance 101	Steering lock 20
- control buttons 71	- S.B.R. system..... 97	Steering wheel adjustment 45
Rear view mirrors 46	- use 96	Steering 193
Rear window washer	Seatbelt tensioners 99	Storing the car 124
- controls 64	Seats 38	Sun roof 76
	Side air bags 110	Sun visors 76
	Side lights	Suspension 193
		Symbols 11

Technical data	187
Third brake light	
- bulb replacement	154
Towing the car	162
Towing trailers	119
Transmission	192
Tyres provided	179
Warning lights and messages	125
Weights	200
Wheel geometry	194
Wheels	194
Window wipers	
- blades	181
- controls	64
- jets	182
Windows (cleaning)	182
Windscreen washer	
- controls	64
- fluid level	175
Windscreen/rear screen washing fluid level	175
Universal Isofix child seats	105

Fiat Group Automobiles S.p.A. - Customer Services - Technical Services - Service Engineering
Largo Senatore G. Agnelli, 5 - 10040 Volvera - Torino (Italia)
Print n. 603.81.883 - 01/2011 - 1 edition



The data contained in this publication is intended merely as a guide. Lancia reserves the right to modify the models and versions described in this booklet at any time for technical and commercial reasons. If you have any further questions please consult your Lancia dealer.
Printed in recycled paper without chlorine.