

Delta

Owner Handbook



WHY CHOOSING GENUINE PARTS

We really know your car because we invented, designed and built it: we really know every single detail. At **Lancia Service authorised workshops** you can find technicians directly trained by us, offering quality and professionalism for all service operations.

Lancia workshops are always close to you for the regular servicing operations, season checks and practical recommendations by our experts.

With Lancia Genuine Parts you keep the reliability, comfort and performance features of your new car unchanged in time: that's why you bought it for.

Always ask for Genuine Parts for the components used on our cars; we recommend them because they come from our steady commitment in research and development of highly innovative technologies.

For all these reasons: **rely on Genuine Parts, because they are the only ones designed by Lancia for your car.**

SAFETY:
BRAKING SYSTEM

ENVIRONMENT: PARTICULATE FILTERS,
CLIMATE CONTROL MAINTENANCE

COMFORT: SUSPENSION
AND WINDSCREEN WIPERS

PERFORMANCE: SPARK PLUGS,
INJECTORS AND BATTERIES

LINEACCESSORI
ROOF RACK BARS, WHEEL RIMS

**CHOOSING GENUINE PARTS IS
THE MOST NATURAL CHOICE**



HOW TO RECOGNISE GENUINE PARTS

To recognise a **Genuine Part**, check that the component bears our brands, always clearly visible on Genuine Parts, from the braking system to windscreen wipers, from shock absorbers to air cleaner.

All **Genuine Parts** undergo **strict controls**, both during design and manufacturing stages, by specialists using **vanguard materials**, to **test the component reliability**.

This to guarantee **performance** and **safety** for you and your passengers on board, for a long time.

Always ask for and make sure a **Genuine Part** has been used.



Air cleaner



Shock absorber



Brake pads

Dear Customer,

We would like to congratulate and thank you for choosing LANCIA.

We have written this handbook to help you get familiar with all the features of your car.

You should read it right through before taking to the road for the first time.

It contains important information, advice and instructions for the use of the car which will help you get the very best out of your LANCIA.

This handbook also provides a description of special features, essential information for the correct care and maintenance of your LANCIA as well as safe driving tips.

Read the warnings and indications, marked with the following symbols:



personal safety;



car safety;



environmental protection.

The enclosed Warranty Booklet lists the services that LANCIA offers to its Customers:

–the Warranty Certificate with terms and conditions for maintaining its validity

– the range of additional services available to LANCIA Customers.

We are sure that these will help you get in touch with your new car and further appreciate it and the care provided by the people at LANCIA.

Enjoy reading and happy motoring!

This Owner Handbook describes all the versions of the LANCIA Delta. As a consequence, you should only consider the information which is related to the trim level, engine and version that you have purchased.

ESSENTIAL INFORMATION!

REFUELLING





Use only diesel fuel for motor vehicles compliant with European specification EN590.

The use of other products or mixtures may damage the engine beyond repair and consequently invalidate the warranty due to the damage caused.

STARTING THE ENGINE



Turn the ignition key to **MAR** and wait for the warning lights  and  to switch off; turn the ignition key to **AVV** and release it as soon as the engine starts.

PARKING ON FLAMMABLE MATERIAL



The catalytic converter develops high temperatures during operation. Do not park the car on grass, dry leaves, pine needles or other flammable material: fire hazard.

RESPECTING THE ENVIRONMENT



The car is fitted with a system that carries out a continuous diagnosis of the emission-related components in order to help protect the environment.

ELECTRICAL ACCESSORIES



If, after buying the car, you decide to add electrical accessories (that may gradually drain the battery), visit a **Lancia Dealership**. They can calculate the overall electrical requirement and check that the car's electric system can support the required load.

CODE CARD (for versions/markets where provided)



Keep the card in a safe place, not in the car. We recommend that you always carry the electronic code provided on the CODE card with you, in case you need to perform an emergency start.



SCHEDULED SERVICING



Correct car maintenance is essential to ensure that the performance, safety features, environmental friendliness and low running costs are unchanged over the years.

THE OWNER HANDBOOK CONTAINS...



...important information and warnings on the correct use and maintenance of your car over time as well as safe driving tips. Pay special attention to the symbols  (personal safety)  (environmental protection)  (car safety).

Refer to the “Warning lights on panel” chapter in this handbook if the message “See Handbook” appears on the display.

SUMMARY



Knowing your car

1

Safety

2

Starting and driving

3

In an emergency

4

Maintenance and care

5

Technical specifications

6

List of contents

7





blank page



Dashboard	8	Interior fittings	81
Control panel and on-board instruments.....	9	Sunroof	86
Display	26	Doors	89
Menu items	30	Electric windows	92
Trip Computer	40	Luggage compartment.....	96
Symbols	42	Bonnet	102
Lancia Code system.....	43	Roof rack/ski rack.....	104
The keys	44	Headlights.....	105
Alarm	48	DST system.....	107
Ignition switch	51	SPORT function	107
Seats	52	Reactive Suspension System	109
Head restraints	55	Driving Advisor	110
Steering wheel	56	Advanced ESP system	117
Rear view mirrors	56	EOBD system	124
Climatic comfort	58	“Dualdrive” electric power steering system	125
Manual climate control system	59	TPMS system	127
Dual-zone automatic climate control system...	61	Parking sensors	131
External lights.....	67	Magic Parking	134
Window cleaning	70	Wiring for radio system	148
Cruise Control	73	Accessories purchased by the owner.....	149
Roof lights.....	75	Refuelling the car	150
Controls	77	Protecting the environment.....	152
Fuel cut-off system.....	80		

DASHBOARD

The presence and position of controls, instruments and gauges may vary depending on the versions.

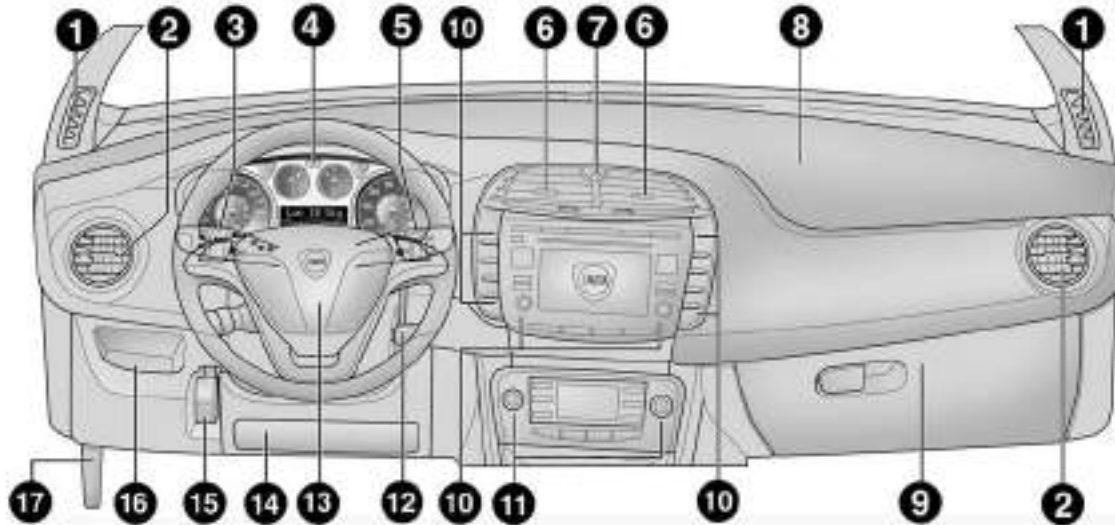

fig. 1

LOE0001m

1. Diffuser for sending air to the side windows - 2. Adjustable and directable air diffuser - 3. Exterior lights control lever - 4. Instrument panel - 5. Windscreen wiper/rear window wiper/trip computer control lever - 6. Adjustable and directable air diffusers - 7. Hazard warning lights switch - 8. Front passenger airbag - 9. Glove compartment - 10. Controls in the dashboard - 11. Climate control system controls - 12. Ignition key and starting device - 13. Driver's airbag - 14. Driver's knee bag (for versions/markets where provided) - 15. Steering wheel locking lever - 16. Fuse box access flap - 17. Bonnet release lever.



CONTROL PANEL AND ON-BOARD INSTRUMENTS



fig. 2

L0E0+00m

VERSIONS WITH MULTIFUNCTION DISPLAY

- A Speedometer (speed indicator)
- B Fuel level gauge with reserve warning light
- C Engine coolant temperature gauge with overheating warning light
- D Rev counter
- E Multifunction display

IMPORTANT The type and background colour of the instruments can vary between different versions.



fig. 3

LOE0402m

“S” SPECIAL SERIES

- A Speedometer (speed indicator)
- B Fuel level gauge with reserve warning light
- C Engine coolant temperature gauge with overheating warning light
- D Rev counter
- E Multifunction display

IMPORTANT The type and background colour of the instruments can vary between different versions.

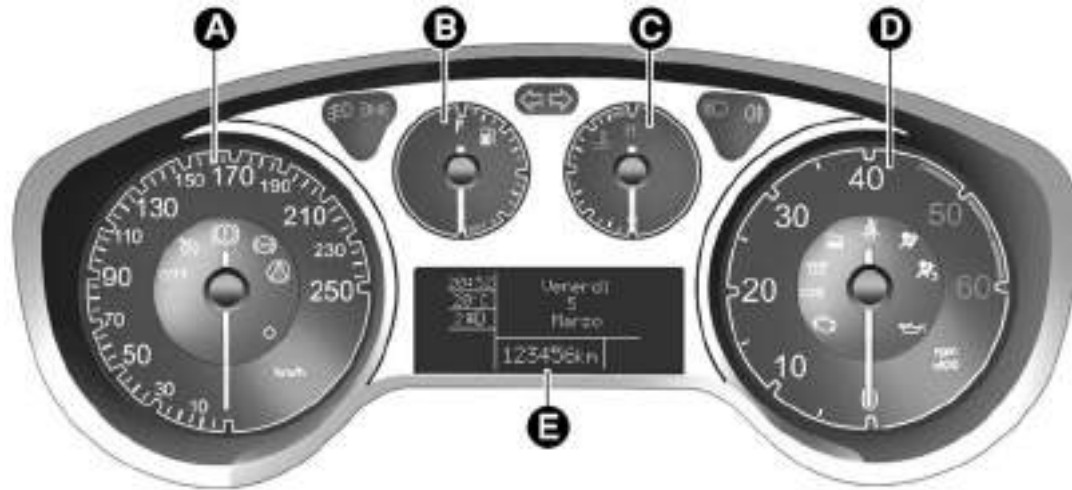

fig. 4

L0E0+01m

VERSIONS WITH RECONFIGURABLE MULTIFUNCTION DISPLAY

- A Speedometer (speed indicator)
- B Fuel level gauge with reserve warning light
- C Engine coolant temperature gauge with overheating warning light
- D Rev counter
- E Reconfigurable multifunction display.

IMPORTANT The type and background colour of the instruments can vary between different versions.

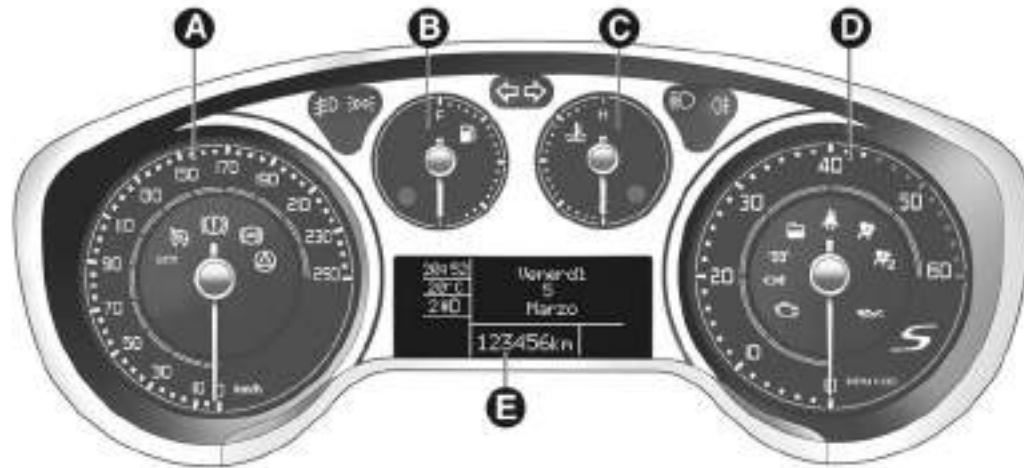

LOE0500m

*fig. 5***“S” SPECIAL SERIES**

- A Speedometer (speed indicator)
- B Fuel level gauge with reserve warning light
- C Engine coolant temperature gauge with overheating warning light
- D Rev counter
- E Reconfigurable multifunction display.

IMPORTANT The type and background colour of the instruments can vary between different versions.



SPEEDOMETER (SPEED INDICATOR)

Indicator A shows the speed of the car.

REV COUNTER

Indicator D shows the engine revs.

FUEL LEVEL GAUGE

Indicator B shows the amount of fuel in the tank.

The  warning light will switch on (together with a message on the display) to indicate there are between 5 and 7 litres of fuel remaining.

Do not travel with the fuel tank almost empty: any gaps in fuel delivery could damage the catalytic converter.

ENGINE COOLANT TEMPERATURE GAUGE

Gauge C shows the temperature of the engine coolant and indicates when the coolant temperature exceeds 50°C. The first reference remains on constantly to indicate that the system is operating correctly. The  warning light switches on (together with a message on the display) to indicate that the temperature of the engine coolant has increased significantly. In this event, stop the engine and go to a Lancia Dealership.

INSTRUMENT PANEL WARNING LIGHTS

Important information

The warning lights switch on together with a dedicated message and/or a buzzer where appropriate. These indications are precautionary and as such must not be considered as exhaustive and/or alternative to the information contained in the Owner Handbook, which you are advised to read carefully in all cases. Always refer to the information in this chapter in the event of a failure indication.



Low brake fluid level (red)

Turning the key to the MAR position illuminates the warning light, but it should switch off after a few seconds. The warning light switches on when the brake fluid in the reservoir falls below the minimum level, possibly due to a leak in the circuit. The display shows the dedicated message.



Handbrake on (red)

When the key is turned to MAR, the warning light switches on but it should switch off after a few seconds. The warning light switches on when the handbrake is engaged. If the car is moving the buzzer will also sound.

IMPORTANT If the warning light turns on when travelling, check that the handbrake is not engaged.



EBD failure

If warning lights  (red) and  (amber) are on at the same time with the engine running, this indicates an EBD system failure or that the system is not available. Early locking of the rear wheels may occur in the event of sharp braking, possibly causing the car to swerve.

Drive very carefully to a Lancia Dealership to have the system inspected immediately. The display will show the dedicated message.



If the  warning light turns on when travelling (with the message on the display) stop the car immediately and contact a Lancia Dealership.



Brake pad wear (amber)

The warning light (or symbol on the display) switches on when the front brake pads show signs of wear; under these circumstances have them replaced as soon as possible. The display shows the dedicated message.

IMPORTANT Because the car is equipped with a wear detection system only for the front brake pads, when these are replaced the rear brake pads should also be checked for wear.





Airbag failure (red)

When the key is turned to MAR, the warning light switches on but it should switch off after a few seconds. The warning light stays on constantly if there is a fault in the airbag system. The display will show the dedicated message.



If the  warning light does not come on when the key is turned to MAR or if it stays on with the car in motion (together with the message on the display) there could be a fault in the restraint systems; under these circumstances, the airbags or pretensioners may not be deployed in the event of an impact or, more rarely, they could be deployed accidentally. Contact a Lancia Dealership to have the system checked immediately.



The failure of the  warning light is indicated by the  warning light flashing longer than the expected 4 seconds, which signals that the front passenger airbag is deactivated. In addition, the airbag system automatically deactivates the passenger side airbags (front airbag and side bag). In this case, the  warning light may not indicate failures in the retaining systems. Before proceeding, contact a Lancia Dealership to have the system checked immediately.



Passenger side airbag/side bags deactivated (amber)

The warning light switches on when the front passenger's airbag and side bag are disabled. With the front passenger airbags activated, when the ignition key is turned to MAR, the warning light switches on constantly for about 4 seconds, flashes for another 4 seconds and should then switch off.



Failure of the warning light is indicated by the warning light coming on. In addition, the airbag system automatically deactivates the passenger side airbags (front airbag and side bag for versions/markets, where provided). Before proceeding, contact a Lancia Dealership to have the system checked immediately.



Seat belts unfastened (red)

This warning light switches on constantly when the car is not in motion and the driver side seat belt is not correctly fastened. The warning light will flash and a buzzer will sound if the car is in motion and the front seat belts are not correctly fastened. The SBR (Seat Belt Reminder) system buzzer can only be permanently deactivated by a Lancia Dealership. The system can be reactivated using the Setup Menu.



Low battery charge (red)

The warning light comes on when the ignition key is turned to MAR, but it should go out as soon as the engine has started (with the engine running at idle speed a brief delay before going out is acceptable). If the warning light stays on, constantly or flashing, contact a Lancia Dealership immediately.



Continuously on: low engine oil pressure (red)

Flashing: engine oil deteriorated (red)

When the key is turned to MAR the warning light comes on, but should go out as soon as the engine is started.

1. Low engine oil pressure

The warning light switches on constantly together (for versions/markets, where provided) with the message on the display when the system detects that engine oil pressure is low.



If the warning light turns on when the car is travelling (on certain versions together with the message on the display) stop the engine and contact a Lancia Dealership immediately.

2. Degraded engine oil (only versions with DPF)

The warning light will turn on flashing together with the message on the display (for versions/markets where provided). Depending on the versions, the warning light flashing modes are as follows:

- for 1 minute every two hours;
- cycles of 3 minutes with intervals with the warning light off for 5 seconds until the oil is changed.

After the first indication, at each engine start up the warning light will continue flashing as described above until the oil is changed. The display (for versions/markets, where provided), shows a dedicated message together with the warning light.

The flashing of the warning light should not be considered as a fault, it simply informs the customer that the oil needs to be changed following normal car use.

Remember that the deterioration of the engine oil is accelerated by:

- mainly town use of the car which makes the DPF regeneration process more frequent
- use of the vehicle for short drives, in which the engine does not have time to reach its regular operating temperature
- repeated interruption of the regeneration process, signalled by the DPF warning light switching on.



Degraded engine oil should be replaced as soon as possible after the warning light comes on, and never more than 500 km after it first comes on. Failure to observe the above indications may result in severe damage to the engine and invalidate the warranty. Remember that when the warning light comes on, it does not mean that the level of engine oil is low, so if the light flashes you definitely do not need to top up the engine oil.



“Dualdrive” electric power steering failure (red)

This warning light switches on when the ignition key is turned to MAR, but it should switch off after a few seconds.

The electric power steering system will not work when the warning light is on and considerably more effort is needed on the steering wheel. The car can still be steered. In this case, go to a Lancia Dealership. The display will show the dedicated message.



“Dualdrive” electric steering engagement

The warning light switches on (or the word “CITY” appears on the display) when the “Dual drive” electric power steering system is activated by pressing the relevant control button. If the button is pressed again the word CITY goes out.



Engine coolant overheating (red)

Turning the key to the MAR position illuminates the warning light, but it should switch off after a few seconds. The warning light turns on when the engine is overheated. If the warning light switches on when driving, proceed as follows:

- when driving normally: stop the car, switch off the engine and check that the water level in the reservoir is not below the MIN mark. If it is, wait for the engine to cool down, then slowly and carefully open the cap, top up with coolant and check that the level is between the MIN and MAX marks on the reservoir. Also check visually for any fluid leaks. In this case, go to a Lancia Dealership if the warning light should switch on when the engine is started again.
- if the vehicle is used under demanding conditions (e.g. towing trailers uphill or fully loaded): slow down and, if the light stays on, stop the car. Wait for 2 or 3 minutes with the engine running and slightly accelerated to further favour the coolant circulation. Then stop the engine. Check the correct coolant level as described above.

IMPORTANT Over demanding routes, it is advisable to keep the engine on and slightly accelerated for a few minutes before switching it off. The display will show the dedicated message.

**Doors not closed correctly (red)**

The warning light switches on when one or more doors are not completely shut. An acoustic signal is activated with the doors open and the car moving. The warning light in the multifunction display also switches on when the bonnet and/or tailgate are not properly shut. The display will show the dedicated message.

**General failure indication (amber)****Fuel cut-off activated**

This warning light (or symbol on the display) switches on when the fuel cut-off system intervenes. The display shows the dedicated message.

Engine oil pressure sensor failure

This warning light (or symbol on the display) switches on when a fault is detected in the engine oil pressure sensor. The display shows the dedicated message.

Dusk sensor failure

This warning light (or symbol on the display) switches on when a fault is detected in the dusk sensor.

Speed limit exceeded

This warning light (amber), or symbol (red) on the display, switches on when the preset speed limit is exceeded (for Arab countries the speed limit is set at 120 km/h). The display shows the dedicated message.

Rain sensor failure

(for versions/markets where provided)

This warning light (or symbol on the display) switches on when a fault is detected in the rain sensor. The display shows the dedicated message.

**Parking sensor fault**

(for versions/markets, where provided)

This warning light (or symbol on the display) switches on when a fault is detected in the parking sensors. The display shows the dedicated message.

Tyre pressure monitoring system failure

(for versions/markets, where provided)

This warning light (or symbol on the display) switches on when a failure is detected in the TPMS (for versions/markets, where provided).

Should one or more wheels without a sensor be fitted, the instrument panel warning light will come on and stay on until the initial conditions are restored. The display shows the dedicated message.

NOTE If one of the failures listed above occurs, contact a Lancia Dealership as soon as possible.

AFS failure

This warning light (or symbol on the display) switches on when a fault is detected in the AFS (see “Headlights” paragraph in this chapter). The display shows the dedicated message.

Steering corrector not available

This warning light (or symbol on the display) switches on when the steering corrector is not available. The display will show the dedicated message.

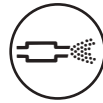
**DPF (diesel particulate filter) cleaning in progress (only versions with DPF) (amber)**

When the key is turned to MAR, the warning light switches on but it should switch off after a few seconds. The warning light turns on constantly when the DPF system needs to eliminate the trapped pollutants (particulate) through the regeneration process.

The warning light does not come on every time the DPF is being regenerated, rather only when the driving conditions are such that the driver needs to know it. To switch the warning light off, the car must be kept moving until the regeneration process is completed.

On average, the process lasts 15 minutes. The best conditions to complete the regeneration process are reached driving the car at about 60 km/h with engine speed over 2000 rpm. When this warning light switches on, it does not indicate a car failure and thus it should not be taken to a workshop. A dedicated message will appear on the display when the warning light switches on (for versions/markets, where provided).



The driving speed must always be suitable for traffic and weather conditions and the driver must always comply with the Highway Code. The engine can also be switched off if the DPF warning light is on; nevertheless, repeated interruptions of the regeneration process could cause an early deterioration of engine oil. For this reason, always wait until the warning light switches off before stopping the engine as described above. It is not advisable to complete DPF regeneration with the car stationary.



Fuel reserve (amber)

When the key is turned to MAR, the warning light switches on but it should switch off after a few seconds. The warning light switches on when about 5 to 7 litres of fuel are left in the tank. The display shows the dedicated message.

IMPORTANT The warning light will blink to indicate a system failure. Go to a Lancia Dealership to have the system checked.





Emission control/injection system failure (amber)

Under normal conditions, when the ignition key is turned to MAR, the warning light switches on, but should switch off as soon as the engine is started.

If the warning light remains on or comes on whilst driving, it means that the injection system is not working properly; in particular, if the warning light comes on constantly, this indicates a malfunction in the supply/ignition system that could cause excessive exhaust emissions, a possible loss of performance, poor driveability and high fuel consumption. On some versions the display shows the dedicated message. Under these conditions, you may continue travelling at a moderate speed without demanding excessive effort from the engine. Prolonged use of the car with the warning light on constantly may cause damage. Go to a Lancia Dealership as soon as possible. The warning light switches off if the malfunction disappears, but it is still stored by the system.



Go to a Lancia Dealership as soon as possible if  warning light either does not light up when the key is turned to MAR or if while travelling the warning light comes on either constantly or flashing (on some versions along with a message in the display). The operation of the  warning light may be checked by the traffic control authorities using specific devices. Comply with the laws and regulations of the country where you are driving.



Advanced ESP system (amber)

When the key is turned to MAR, the warning light switches on but it should switch off after a few seconds. If the warning light does not switch off or stays on together with the LED on the ASR button when travelling, contact a Lancia Dealership. On some versions, the display shows the dedicated message. If the warning light flashes when driving, this indicates that the Advanced ESP system is activated.

If the battery is disconnected, the  warning light will switch on (together with a message in the display) to indicate that the system must be realigned.



To switch the warning light off, carry out the following initialisation procedure:

- turn the ignition key to MAR;
- turn the steering wheel fully both clockwise and anti-clockwise (to move from the position with the wheels straight);
- turn the ignition key to STOP and then to MAR.

If the  warning light does not go out after a few seconds, go to a Lancia Dealership.



Hill Holder failure (amber)

The  warning light switches on to indicate a Hill holder system failure. In this case, contact a Lancia Dealership as soon as possible. Alternatively, on some versions the  symbol switches on in the display. The display will show the dedicated message.



Glow plug preheating

This warning light switches on when the key is turned to MAR. It will switch off as soon as the glow plugs have reached a preset temperature. Start the engine as soon as the warning light switches off. **IMPORTANT** In hot outside temperatures, the warning light may stay on for only a very short time.

Glow plug preheating failure

The warning light flashes if there is a fault in the glow plug preheating system. Go to a Lancia Dealership as soon as possible. The display will show the dedicated message.

**Water in diesel filter (amber)**

When the key is turned to MAR, the warning light switches on but it should switch off after a few seconds. The warning light turns on when there is water in the diesel filter. The display will show the dedicated message.



The presence of water in the supply circuit may cause severe damage to the injection system and irregular engine operation. If  warning light lights up (on some versions with the message on the display), go to a Lancia Dealership as soon as possible to have the system bled. Water may have entered the tank if this appears immediately after refuelling: if this happens, switch the engine off immediately and contact a Lancia Dealership.

**ABS failure (amber)**

When the key is turned to MAR, the warning light switches on but it should switch off after a few seconds. The warning light will light up when the system is either not working or not available. In this case the braking system will work as normal, but without the extra performance offered by the ABS. Drive carefully and go to a Lancia Dealership as soon as possible.

The display will show the dedicated message.



Lancia Code system failure (amber)

This warning light (or symbol on the display), when on constantly with the ignition key turned to MAR, indicates a possible failure (see “Lancia Code system”).

If the  warning light (or symbol in the display) is flashing with engine running, this means that the car is not protected by the engine immobiliser device (see “Lancia Code system”).

Contact a Lancia Dealership to have all the keys programmed.

Alarm failure

(for versions/markets, where provided)

A failure in the alarm system is signalled by this warning light (or symbol in the display) switching on. Contact a Lancia Dealership as soon as possible.

The display shows the dedicated message.

Break in attempt

(for versions/markets, where provided)

This warning light (or symbol on the display) switches on when a break-in attempt is detected. Contact a Lancia Dealership as soon as possible.

The display will show the dedicated message.



Insufficient tyre pressure

(for versions/markets, where provided)

When the key is turned to MAR, the warning light switches on, but it should switch off after a few seconds. The warning light (amber), or symbol in the display (red), switch on when the inflation pressure of one or more tyres falls below a preset level. In this way the TPMS warns the driver and signals the possibility of the tyre being dangerously deflated and a probable puncture (see paragraph “TPMS” in this chapter).

IMPORTANT Do not continue driving with one or more flat tyres as handling may be compromised. Stop the car, avoiding harsh braking or steering manoeuvres. Replace the wheel immediately with the space-saver wheel (for versions/markets where provided) or carry out a repair using the dedicated kit (see “Changing a wheel” in the chapter “4”) and contact a Lancia Dealership as soon as possible.

Check tyre pressures

When the key is turned to MAR, the warning light (for versions/markets, where provided) switches on, but it should switch off after a few seconds.

The warning light (or symbol in the display) switches on to show the flat tyre (see “TPMS” paragraph in this chapter).

Should two or more tyres be flat, the display will show the indications corresponding to each tyre in sequence. Restore the correct inflation pressure values as soon as possible (see paragraph “Cold inflation pressures” in chapter “6”).

Tyre pressure unsuitable for speed

When the key is turned to MAR, the warning light (for versions/markets, where provided) switches on, but it should switch off after a few seconds.

Should it be necessary to travel at a speed higher than 160 km/h, inflate the tyres more than the pressure value specified in paragraph “Inflation pressures” in chapter “6”. If the TPMS (for versions/markets where provided) detects that the pressure of one or more tyres is unsuitable for the current speed, the warning light or symbol will switch on (together with the message on the display) (see “Tyre pressure low” paragraph in this chapter) and it will stay on until the car slows down to a speed below the pre-set threshold (see “TPMS” paragraph in this chapter).

IMPORTANT In this case, slow down immediately because tyre overheating could damage tyre performance and durability beyond repair, and may even make the tyre explode.



Particularly strong radio-frequency interference may cause the TPMS to function incorrectly. The driver is notified of this condition through a message (for versions/markets, where provided).

The message will disappear automatically as soon as the interference ceases to disturb the system.



Exterior lights failure (amber)

This warning light (or symbol on the display) switches on when a fault is detected in any of the following lights:

- side lights;
- brake lights (for versions/markets where provided);
- rear fog lights;
- direction indicators;
- number plate lights;
- daytime running lights.

The failure relating to these lights could be: one or more blown bulbs, a blown protection fuse or a break in the electrical connection.

The display shows the dedicated message.



Rear fog lights (amber)

The warning light comes on when the rear fog lights are turned on.



Front fog lights (green)

The warning light comes on when the fog lights are turned on.



Direction indicators (green - intermittent)

The warning lights switch on when the direction indicator control stalk is moved downwards, upwards or when the hazard warning light button is pressed.



Daytime running lights/dipped beam headlights (green)

This warning light switches on when the daytime running lights or dipped beam headlights are activated.

Follow me home

This warning light switches on when this device is activated (see “Follow Me Home” in this chapter). The display will show the dedicated message.



Main beam headlights (blue)

The warning light switches on when the main beam headlights are turned on.



Cruise Control (green)

(for versions/markets, where provided)

When the key is turned to MAR, the warning light switches on but it should switch off after a few seconds. The warning light is lit up on the display by rotating the Cruise Control ring nut to ON. The display will show the dedicated message.

DISPLAY

The car may be provided with a multifunction/reconfigurable multifunction display that shows useful information, according to the previous settings, when driving.

MULTIFUNCTION DISPLAY “STANDARD” SCREEN fig. 6

The standard screen shows the following information:

- A. Date
- B. Possible Dualdrive electric power steering engagement
- C. Sport driving mode indication
(for versions/markets where provided)
- D. Time
- E. Milometer (display of distance travelled in kilometres/miles)
- F. Possible ice on the road indication
- G. Outside temperature
- H. Scheduled servicing interval
- I. Headlight alignment position (only with dipped beam headlights on).

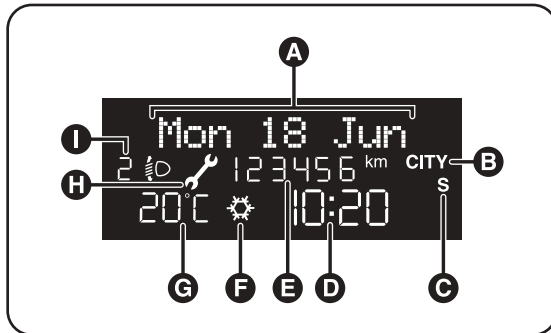

fig. 6

L0E1000g



**RECONFIGURABLE MULTIFUNCTION
“STANDARD” DISPLAY fig. 7**

The standard screen shows the following information:

- A. Time
- B. Date
- C. Sport driving mode indication (for versions/markets where provided)
- D. Milometer (display of distance travelled in kilometres/miles)

- E. Car status indications (e.g. doors open, possible ice on road, etc.)/Gear Shift Indicator (for versions/markets, where provided)
- F. Headlight alignment position (only with dipped headlights on)
- G. Outside temperature

On some versions, when the “Engine info” menu item is selected, the display shows the turbine pressure when the ignition is turned to the MAR position, fig. 8.

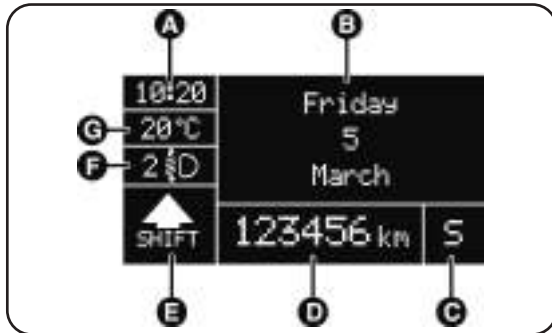

fig. 7

L0E1033g

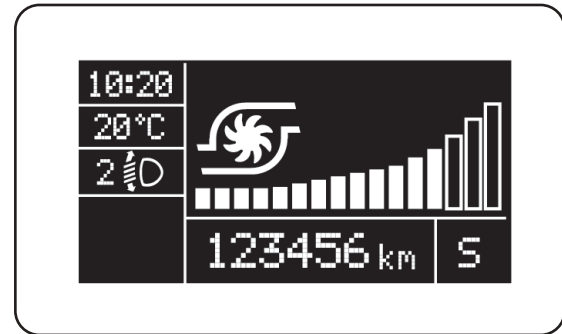

fig. 8

L0E0004m

GEAR SHIFT INDICATOR

The GSI system (Gear Shift Indicator) suggests to shift gear by showing an indication on the control panel (see fig. 9).

Through the GSI, the driver is notified that the gear change will allow a reduction in fuel consumption.

When the SHIFT UP icon (▲ SHIFT) is shown on the display, the GSI is advising the driver to select a higher gear, while the SHIFT DOWN (▼ SHIFT) icon suggests that a lower gear should be engaged.

NB The indication on the instrument panel remains on until the driver changes gear or until the driving conditions return to a situation where a gear change is not required, to reduce consumption.



fig. 9

L0E1025g

CONTROL BUTTONS fig. 10

▲: To scroll upwards through the displayed menu and the related options or to increase the displayed value.

SET: press to access the menu and/or go to the next screen or confirm your choice. Hold down to go back to the standard screen.

▼: to scroll downwards through the displayed menu and the related options or to decrease the displayed value.

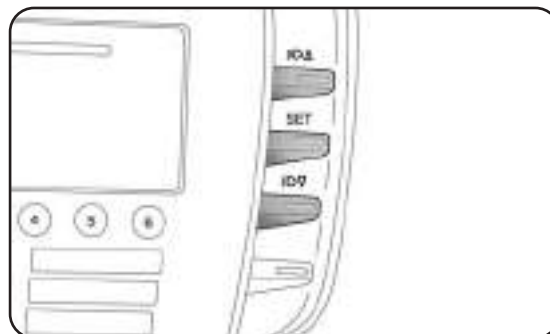

fig. 10

L0E0005m



IMPORTANT Buttons **▲** and **▼** activate different functions according to the following situations:

- within the menu, they allow you to scroll up and down through the options;
- during setting operations they increase or decrease the values.

IMPORTANT When one of the front doors is opened, the display will switch on and show the clock and km or miles covered for a few seconds.

SETUP MENU

The menu comprises a series of items which can be selected using the **▲** and **▼** buttons to access the different selection and setting operations (set up) described in the following paragraphs. Some options have a submenu. The Setup Menu can be activated by briefly pressing the SET button. The menu includes the following items:

- MENU
- LIGHTING
- SPEED BEEP
- LIGHT SENSOR
(for versions/markets, where provided)
- CORNERING LIGHTS
(for versions/markets, where provided)
- TRIP B ACTIVATION/DATA
- SET TIME
- SET DATE
- FIRST PAGE (for versions/markets, where provided)
- SEE RADIO
- AUTOCLOSE
- UNITS OF MEASURE
- LANGUAGE
- WARNING VOLUME
- BUTTONS VOLUME
- SEAT BELT BEEP/BUZZ.
- SERVICE
- AIRBAG/PASSENGER BAG
- DAYTIME RUNNING LIGHTS
- EXIT MENU

Selection of an option from main menu without submenu:

- press the SET button briefly to select the main menu setting you wish to change;
- press Δ or ∇ (with single presses) to select the new setting;
- press the SET button briefly to store the new setting and go back to the main menu option selected previously.

Selecting an option from the main menu with a submenu:

- briefly press the SET button to display the first submenu option;
- press Δ or ∇ (with single presses) to scroll through all the submenu options;
- briefly press the SET button to select the displayed submenu option and to open the relevant settings menu;
- press Δ or ∇ to select the new setting for this submenu option;
- press the SET button briefly to store the new setting and go back to the previous submenu option.

MENU ITEMS

Lighting (Passenger compartment light adjustment)

This function is used to set the brightness of the instrument panel, sound system controls and automatic climate control system controls (for versions/markets where provided) to 8 levels.

Proceed as follows to adjust the brightness:

- press the SET button briefly to make the display flash the previously set level;
- press button Δ or ∇ to adjust the brightness level;
- briefly press the SET button to go back to the menu screen or hold the button down to go back to the standard screen without saving.

Speed warning (Speed limit)

This function allows the car speed limit to be set (km/h or mph) and the driver will be notified when it is exceeded (see “Warning lights on panel” section in chapter 1). To set the desired speed limit, proceed as follows:

- press the SET button briefly, the display will show the dedicated message;
- press the Δ or ∇ button to select speed limit activation (On) or deactivation (Off);
- when the function is activated (On), press the Δ or ∇ button to select the desired speed limit and press SET to confirm the choice.



IMPORTANT Setting is possible between 30 and 200 km/h, or 20 and 125 mph, according to the previously set unit. See the “Measurement unit adjustment (Measurement unit)” paragraph described below. The setting will increase/decrease by five units each time Δ/∇ is pressed. Hold down button Δ/∇ to increase/decrease the setting rapidly. Complete the adjustment with single presses of the button when you approach the desired value.

– briefly press the SET button to go back to the menu screen or hold the button down to go back to the standard screen without saving.

To cancel the setting, proceed as follows:

- press the SET button briefly to make the display flash (On);
- press the ∇ button to make the display flash (Off);
- press the SET button briefly to return to the menu screen or press the button for longer to return to the standard screen without memorising.

Headlight sensor (automatic/dusk sensor headlights sensitivity adjustment)

(for versions/markets, where provided)

This function is used to adjust the dusk sensor sensitivity to three levels (level 1 = minimum, level 2 = medium, level 3 = maximum); the higher the sensitivity, the lower the amount of external light needed to switch the headlights on.

Proceed as follows to set:

- press the SET button briefly to make the display flash the previously set level;
- press Δ or ∇ to make your choice;
- briefly press SET to go back to the menu screen or hold the button down to go back to the standard screen without saving.

Cornering lights (activation/deactivation of cornering lights - fog lights with cornering function) (for versions/markets where provided)

This function activates/deactivates the cornering lights. To activate/deactivate (ON/OFF) the lights, proceed as follows:

- press the SET button briefly, the display will show “On” or “Off” flashing depending on the previous setting;
- press **Δ** or **∇** to make your choice;
- briefly press the SET button to go back to the menu screen or hold the button down to go back to the standard screen without saving.

Trip B data/activation (Trip B enablement)

This function can be used to activate (On) or deactivate (Off) the Trip B display (partial trip).

For further information see “Trip computer”.

Proceed as follows to switch the function on/off:

- press the SET button briefly to make the display flash On or Off depending on the previous setting;
- press **Δ** or **∇** to make your choice;
- briefly press SET to go back to the menu screen or hold the button down to go back to the standard screen without saving.

Time adjustment (Clock adjustment)

This function enables the clock to be set through two sub-menus: “Time” and “Format”.

To carry out the adjustment, proceed as follows:

- briefly press the SET button and two submenus “Time” and “Format” are displayed;
- press the **Δ** or **∇** button to move between the two sub-menus;
- once you have selected a sub-menu, press SET briefly;
- when you select “Time”, briefly pressing SET makes the hours flash on the display;
- press **Δ** or **∇** to adjust the value;
- briefly press the SET button and the minutes will flash on the display;
- press **Δ** or **∇** to adjust the value.



IMPORTANT The setting increases or decreases by one unit each time button Δ or ∇ is pressed. Hold down the button to increase/decrease the setting rapidly and automatically. Complete the adjustment with single presses of the button when you approach the desired value.

- when you select “Format”, pressing SET briefly makes the display mode flash on the display;
- press button Δ or ∇ to select “24h” or “12h”.

When you have made the required settings, briefly press the SET button to go back to the submenu screen or hold the button down to go back to the main menu screen without storing the new settings.

- press the SET button again for a long time to return to the standard screen or to the main menu according to where you are in the menu.

Set date (Setting the date)

This function may be used to update the date (year – month – day).

Proceed as follows to update:

- briefly press SET: the “year” flashes on the display;
- press Δ or ∇ to adjust the value;
- briefly press SET: the “month” flashes on the display;
- press Δ or ∇ to adjust the value;
- briefly press SET: the “day” flashes on the display;
- press Δ or ∇ to adjust the value.

IMPORTANT The setting increases or decreases by one unit each time button Δ or ∇ is pressed. Hold down the button to increase/decrease the setting rapidly and automatically. Complete the adjustment with single presses of the button when you approach the desired value.

Briefly press SET to go back to the menu screen or hold the button down to go back to the standard screen without saving.

**Initial page
(display of information on the main screen)**
(for versions/markets, where provided)

This function allows you to choose the information you would like to see on the main screen. You can choose to display the date or the turbocharger supercharging pressure.

To make your choice, proceed as follows:

- briefly press SET: “Initial page” will appear on the display;
- press the SET button again briefly to display the “date” and “engine info” options;
- press **▲** or **▼** to select the information you wish to see on the main page of the display;
- briefly press the SET button to go back to the menu screen or hold the button down to go back to the standard screen without saving.

When the key is turned to MAR and the initial check stage is over, the display will show the information selected via the “First page” menu function.

See radio (audio information display)

With this function the display shows information about the sound system.

- Radio: selected station frequency or RDS message, automatic tuning activation or AutoStore;
- Audio CD, MP3 CD: track number;
- CD Changer: CD number and track number;

To show the radio information on the display (On) or clear it (Off), proceed as follows:

- briefly press the SET button: the display flashes On or Off depending on the previous setting;
- press **▲** or **▼** to make your choice;
- briefly press the SET button to go back to the menu screen or hold the button down to go back to the standard screen without saving.

Autoclose (Automatic central locking with car running)

When activated (On), this function locks the doors automatically when the vehicle speed exceeds 20 km/h.

Proceed as follows to activate or deactivate this function:

- press the SET button briefly to display a submenu;
- press the SET button briefly to make the display flash



On or Off depending on the previous setting;

- press **Δ** or **∇** to make your choice;
- press the SET button briefly to return to the submenu screen or hold the button down to return to the main menu screen without saving;
- hold down the SET button again to return to the standard screen or to the main menu according to where you are in the menu.

Unit of measurement (Setting the unit of measurement)

With this function is possible to set the unit of measurement in three submenus: “Distance”, “Consumption” and “Temperature”. To set the required unit proceed as follows:

- briefly press SET to display the three sub-menus;
- press the **Δ** or **∇** button to move between the three sub-menus;
- once the submenu to be modified has been selected, briefly press the SET button;
- if the submenu “Distance” is entered: by briefly pressing SET the display shows “km” or “mi” depending on the previous setting;
- press **Δ** or **∇** to make your choice;
- when you select “Consumption”, pressing SET button makes km/l, l/100km or mpg appear on the display depending on the previous setting;

If the set distance unit is “km”, the fuel consumption unit will be displayed in km/l or l/100 km.

If the set distance unit is “mi” the fuel consumption unit will be displayed in “mpg”.

- press **Δ** or **∇** to make your choice;
- when you select “Temperature”, pressing SET makes °C or °F appear on the display depending on the previous setting;
- press **Δ** or **∇** to make your choice;

When you have made the required settings, briefly press the SET button to go back to the submenu screen or hold the button down to go back to the main menu screen without storing the new settings.

- press the SET button again for a long time to return to the standard screen or to the main menu according to where you are in the menu.

Language (Language selection)

Display messages can be shown in different languages: Italian, German, English, Spanish, French, Portuguese and Dutch.

To set the desired language, proceed as follows:

- briefly press the button SET: the previously set language starts flashing on the display;
- press **Δ** or **∇** to make your choice;
- briefly press the SET button to go back to the menu screen or hold the button down to go back to the standard screen without saving.

Warnings volume (Adjusting the failure/warning acoustic signal volume)

With this function the volume of the acoustic signal which accompanies the display of failure/warning can be adjusted according to 8 levels.

To set the desired volume, proceed as follows:

- press the SET button briefly, making the display flash the previously set volume level;
- press **Δ** or **∇** to adjust the value;
- briefly press SET to go back to the menu screen or hold the button down to go back to the standard screen without saving.

Button volume (Adjusting the button volume)

This function enables you to adjust the volume of the acoustic signal (8 settings) accompanying the activation of buttons SET, **Δ** and **∇**.

To set the desired volume, proceed as follows:

- press the SET button briefly, making the display flash the previously set volume level;
- press **Δ** or **∇** to adjust the value;
- briefly press the SET button to go back to the menu screen or hold the button down to go back to the standard screen without saving.

Belt reminder (Buzzer/reactivation for SBR indication)

This function is only displayed after a Lancia Dealership has deactivated the SBR (see SBR paragraph, chapter “2”).

Service (Scheduled servicing)

This function allows you to display the information about km/mileage intervals or, for versions/markets, where provided, time intervals for car servicing.



To consult this information, proceed as follows:

- briefly press the SET button: the display shows when servicing is due in km/mi or days (where provided) or mi or days (where provided) according to the previous setting (see paragraph “Units of measurement”);
- briefly press SET to go back to the menu screen or hold the button down to go back to the standard screen.

IMPORTANT The “Scheduled Servicing Plan” includes car maintenance at fixed intervals, refer to the “Maintenance and care” chapter. This is displayed automatically, with ignition key at MAR-ON, 2000 km (or equivalent value in miles) before servicing or, where provided, 30 days before servicing. It is also displayed each time the key is turned to MAR-ON or, for versions/markets, where provided, every 200 km (or equivalent value in miles). Below this threshold servicing indications are more frequent. The display will be in km or mi depending on the settings of the unit of measurement. When the next scheduled service is approaching, the word “Service” will appear on the display, followed by the number of kilometres/miles or days (where provided) left, when the key is turned to MAR-ON. Contact a Lancia Dealership where the operations of the "Scheduled Servicing Plan" will be performed and the message will be reset. When the service interval is reached and for about 1000 km/600 mi or 30 days, a “Service interval elapsed” message is displayed.

Airbag/Passenger airbag

This function is used to activate/deactivate the front passenger’s airbag.

Proceed as follows:

- press SET and, after the message Bag pass: Off (to deactivate) or Bag pass: On (to activate) is displayed by pressing buttons **▲** and **▼**, press SET again;
- the confirmation request message will be displayed;
- press **▲** or **▼** to select Yes (to confirm activation/deactivation) or No (to abort);
- press the SET button briefly, a message confirming the selection will be displayed and you will return to the menu screen or, pressing the button for longer, you will return to the standard screen without memorising.

Daytime lights (D.R.L. - Daytime Running Lights)

With this function is possible to turn the daytime running lights on and off.

Proceed as follows to activate or deactivate this function:

- press the SET button briefly to display a submenu;
- press the SET button briefly to make the display flash On or Off depending on the previous setting;
- press **Δ** or **∇** to make your choice;
- press the SET button briefly to return to the submenu screen or hold the button down to return to the main menu screen without saving;
- hold down the SET button again to return to the standard screen or to the main menu according to where you are in the menu.

Menu exit

This is the last function that closes the cycle of settings listed in the menu screen. Pressing the SET button briefly will return the display to the standard screen without storing. Press **∇** to return to the first menu option (Speed Beep).

DISPLAY READINGS

IMPORTANT Failure indications displayed are divided into two categories: very serious and less serious failures. Very serious faults prompt a prolonged cycle of signals. Less serious faults prompt a shorter cycle of signals. The displaying cycle of both failure categories can be stopped by pressing the button SET. The warning light (or symbol) will stay on until the fault is eliminated.



Luggage compartment not properly shut (red)

This symbol (for versions/markets where provided) switches on in the display when the luggage compartment is not properly shut. The display shows the dedicated message.



Bonnet not properly shut (red)

This symbol (for versions/markets where provided) switches on in the display when the bonnet is not properly shut. The display will show the dedicated message.



Exterior lights failure (amber)

The symbol switches on in the display when a fault is detected in the brake lights. The display shows the dedicated message.



Possible presence of ice on the road

The outside temperature indicator starts flashing when the outside temperature reaches or falls below 3°C and the ❄️ symbol lights up on the display to warn the driver of the possible presence of ice on the road. The display will show the dedicated message.



Driving advisor on

The display shows a dedicated message when the driving advisor function is switched on.



Adaptive lights not available

The display shows the dedicated message when the adaptive lights system is not available. Contact a Lancia Dealership.



Steering corrector not available (DST - Dynamic Steering Torque)

The display shows a dedicated message when the steering corrector is faulty. Contact a Lancia Dealership.



Service due

The display shows a specific message to indicate the scheduled servicing deadline.

Speed limit exceeded

The display shows a dedicated message when the preset speed limit is exceeded (for Arab countries the speed limit is set at 120 km/h). The icon shown on the display represents the set speed limit.

TRIP COMPUTER

GENERAL INFORMATION

The Trip computer is used to display information on car operation when the key is turned to MAR. This function is composed of separate trips, called “Trip A” and “Trip B” which can monitor the entire mission (journey) in a reciprocally independent manner.

Both functions can be reset (reset means start of a new journey). “Trip A” is used to display the figures relating to:

- Range
- Trip distance
- Average consumption
- Instantaneous consumption
- Average speed
- Travel time (driving time).
- Trip A Reset

“Trip B” may be used to display the figures relating to:

- Distance travelled B
- Average consumption B
- Average speed B
- Trip time B (driving time).
- Trip B Reset

N.B. “Trip B” may be disabled (see “Activating Trip B”). “Range” and “Instant consumption” parameters cannot be reset.

Values displayed

Range

This indicates the approximate distance which can be travelled with the amount of fuel present in the tank. The display will show the reading ‘----’ when the following events take place:

- range value lower than 50 km (or 30 mi)
- in case of car parked with engine running for an extended period.

IMPORTANT The range can be affected by several factors: driving style (see “Driving style” in the “Starting and driving” chapter), type of route (motorway, towns and cities, mountain roads, etc.), conditions of use (load, tyre pressures, etc.). Trip planning must therefore take the above into account.

Distance travelled

This indicates the approximate distance covered from the start of the new mission.



Average fuel consumption

This value shows the approximate average fuel consumption from the start of the new journey.

Instant fuel consumption

This indicates any change in fuel consumption. The value is constantly updated. The display will show “----” if the car is parked with the engine running.

Average speed

This value shows the car’s average speed based on the overall time elapsed since the start of the new journey.

Trip time

Time elapsed since the start of the new journey.

Trip Reset

This resets the Trip computer settings

TRIP control button fig. 11

The TRIP button is located on the right hand lever. With the ignition key turned to MAR, this button allows you to view the previously described parameters and also reset them to begin a new mission:

- brief press to access the various parameter displays;
- long press to reset and then start a new mission.

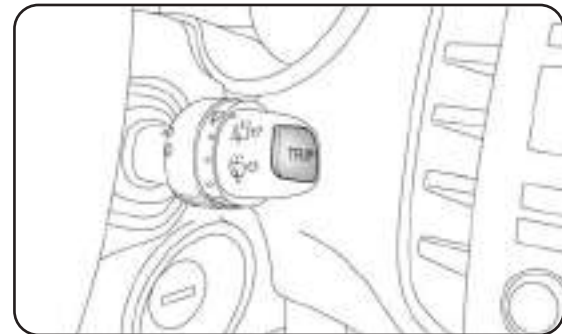

fig. 11

L0E0007.m

New mission

This begins after a reset:

- “manual” resetting by the user, by pressing the relevant button;
- “automatic” resetting, when the “Trip distance” reaches 9999.9 km or when the “Travel time” reaches 99.59 (99 hours and 59 minutes);
- after disconnection/reconnection of the battery.

IMPORTANT The reset operation when “Trip A” details are being displayed resets the information associated with this function only.

IMPORTANT The reset operation when “Trip B” details are being displayed resets the information associated with this function only.

Start of journey procedure

With the ignition key in the MAR position, reset by pressing the TRIP button and keeping it pressed for more than 2 seconds.

Trip Exit

You can automatically exit the TRIP function once all the values have been displayed or by holding the SET button down for more than 1 second.

SYMBOLS

Special coloured labels have been attached near to or on some of the components of your car. These labels bear symbols that remind you of the precautions to be taken with regard to that particular component. A plate summarising these symbols can be found under the bonnet.



THE LANCIA CODE SYSTEM

This is an electronic engine locking system which increases protection against attempted thefts of the car. It is automatically activated when the ignition key is removed.

Each key contains an electronic device which modulates the signal emitted during ignition by an antenna built into the ignition device. The signal is the “password”, different every time the car is started, through which the control unit recognises the key and enables starting.

OPERATION

Each time the car is started by turning the ignition key to MAR, the Lancia CODE system control unit sends an acknowledgement code to the engine control unit to deactivate the immobiliser.

The code is sent only if the control unit of the Lancia CODE system has acknowledged the code received from the key.



Each time the ignition key is turned to STOP, the Lancia CODE system deactivates the functions of the management engine control unit.

If the code is not recognised correctly during ignition, the  warning light (or symbol in the display) comes on.

In this case turn the key to STOP and then to MAR; if it is still locked, try again with the spare set of keys. Contact a Lancia Dealership if you still cannot start the engine.

IMPORTANT Each key has its own code which must be stored by the system control unit. To have new keys programmed (up to a maximum number of eight keys), contact a Lancia Dealership and be ready to present all the keys you have in your possession, the CODE card, a personal identity document and the car ownership documents. The key codes not presented during the programming procedure will be deleted to ensure that any keys that are lost or stolen cannot be used to start the engine.

warning light (or symbol in the display) switching on whilst driving

- If the  warning light (or symbol in the display) switches on, this means that the system is running a self-diagnosis test (caused, for example, by a voltage drop).
- If the  warning light (or symbol in the display) remains on, contact a Lancia Dealership.



Violent shocks may damage the electronic components inside the key.

THE KEYS

CODE CARD (for versions/markets, where provided)

A CODE card, fig. 12, is provided together with the vehicle keys. This must be presented to a Lancia Dealership should you require any duplicate keys.

IMPORTANT In order to ensure perfect efficiency of the electronic devices contained inside the keys, they should never be exposed to direct sunlight.



The ignition key and the CODE card must be handed over to the new owner when selling the car.

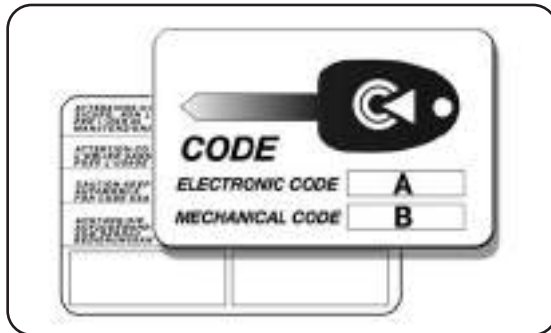

fig. 12

LOE0102m

KEY WITHOUT REMOTE CONTROL

(for versions/markets, where provided)

The key is provided with a metal insert A - fig. 13, which operates:

- the ignition switch;
- the door locks;

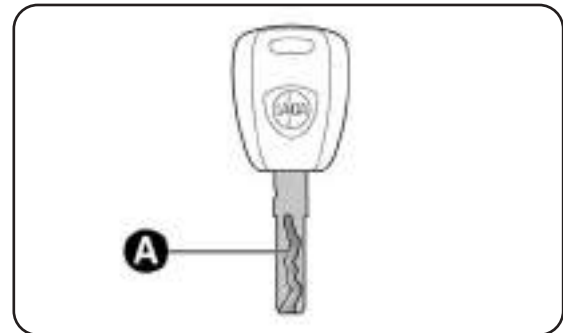

fig. 13

LOE0103m



KEY WITH REMOTE CONTROL fig. 14

The key is provided with a metal insert A, which operates:

- the ignition switch
- the door locks

To open/close the metal insert, press button B.

Button  remotely releases the doors locks.

In this case the timed lighting of interior courtesy lights and double flashing of direction indicators (for versions/markets where provided) takes place.

Pressing button  for longer than 2 seconds: window opening.

Button  locks all the doors remotely.

In this case the interior roof lights switch off and the direction indicators flash once.

Pressing button  for longer than 2 seconds: window closing.

If one or more door are open, the doors will not be locked.

Button  is used to open the boot remotely.

The opening of the tailgate is signalled by the direction indicators flashing twice; when it is closed there is one flash (only with the alarm on, for versions/markets where provided).

Button B activates power-assisted opening of metal insert A.

To reinsert the metal insert into the grip, hold down button B and turn the insert in the direction shown by the arrow until you hear it click into place. After locking, release button B.

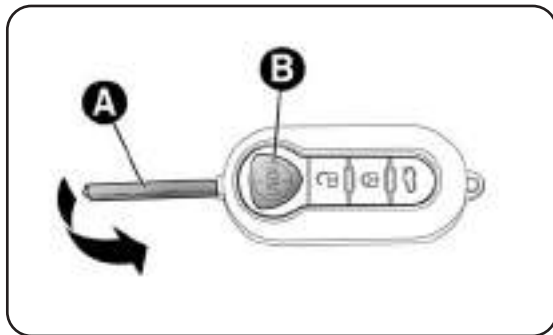





fig. 14



L0ED104m



If the button for locking the doors  is accidentally pressed from the inside, only the doors opened for getting out of the car are released; the tailgate remains locked. To realign the system the locking/unlocking buttons  / .



must be pressed again. Only press button B - fig. 11 when the key is away from the body, particularly from your eyes and other objects that may be damaged (e.g. clothing). Do not leave the key unattended, to prevent people, especially children, from inadvertently pressing the button.

- turn the screw C to  using a fine bit screwdriver;
- take out the battery case D and replace the battery E, respecting its polarity;
- refit the battery case D inside the key and lock it by turning the screw C to .



Used batteries are harmful to the environment. They should be disposed of as specified by law in special containers or taken to a Lancia Dealership, which will take care of their disposal.

Request for additional remote controls

The system can recognise up to 8 keys with incorporated remote control. Should a new remote control be necessary, contact a Lancia Dealership and be ready to present the CODE card, a personal identity document and the car's ownership documents.

Replacing the battery of a key with remote control fig. 15

To replace the battery, proceed as follows:

- press button A and bring the metal insert B to the open position;

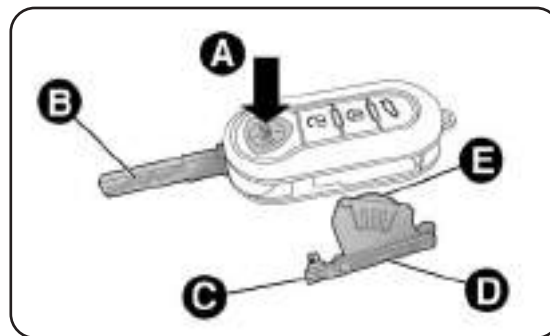

fig. 15



Changing the remote control cover fig. 16

Proceed as shown in the figure to replace the remote control cover.

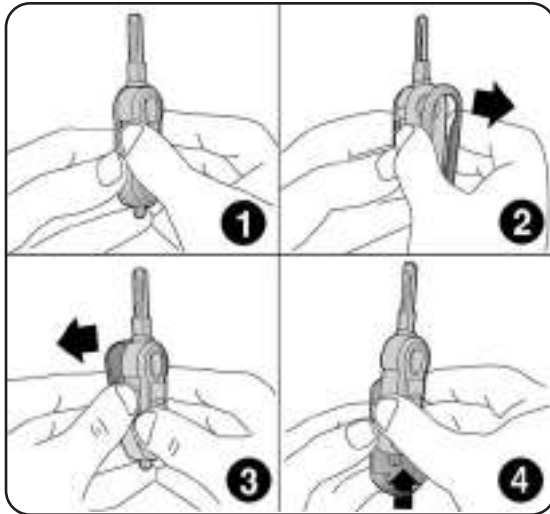

fig. 16

L0E0106m

SAFE LOCK DEVICE

(for versions/markets where provided)

This safety device inhibits the operation of the interior door handles and the door locking/unlocking button. We recommend that you activate this device each time you park your car.

Activating the device

The device engages on all the doors by quickly double-pressing the button on the key.

The activation of the device is indicated by three flashes of the direction indicators and the flashing of the LED on button A fig. 17. The device will not switch on if one or more doors are not closed correctly.

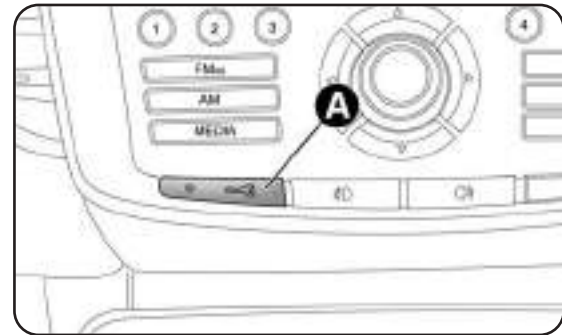



fig. 17

L0E0043m

Deactivating the device

The device deactivates automatically by:

- opening the driver's door using the metal insert;
- pressing the  button on the remote control;
- turning the ignition key to the MAR position



Once the safe lock system is engaged, it is impossible to open the doors from inside the car. Therefore, before getting out of the car check that there is no one left on board. If the remote control battery is flat, the device can only be disengaged by using the metal insert in either of the door locks.

ALARM

(for versions/markets, where provided)

The alarm, in addition to all the remote control functions described previously, is controlled by the receiver located under the dashboard near the fuse box.

ALARM ACTIVATION

The alarm intervenes in the following cases:

- when a door, the bonnet or the tailgate is opened illegally (perimeter protection);
- when the ignition system is operated (ignition key turned to MAR);
- cutting of the battery cables;
- movement inside the passenger compartment (volumetric protection);
- when the vehicle is lifted or tilted.

Depending on the market, the activation of the alarm causes the activation of the siren and the direction indicators (for about 26 seconds). Alarm tripping and the number of cycles depend on the sales market.

There is a maximum number of acoustic/visual cycles. When this is reached the system returns to normal operation.

The volume sensing and anti-lift protection can be excluded by adjusting the dedicated control on the front roof light (see "Volumetric/anti-lift protection").





IMPORTANT The engine immobiliser function is guaranteed by the Lancia CODE, which is automatically activated when the ignition key is extracted from the starter device.

TURNING THE ALARM ON

With the doors and bonnet closed and the ignition key either turned to STOP or removed, point the key with the remote control towards the vehicle and press and release button .

Excluding some markets, the system produces an acoustic signal (beep) and enables door locking.

The switching on of the alarm is preceded by a self-diagnosis stage: if a fault is detected, the system emits a new acoustic signal together with the display of a message (see “Panel warning lights” chapter).

In this case switch off the alarm by pressing , check that all the doors, bonnet and tailgate are closed correctly; then switch the alarm back on by pressing .

If a door or the bonnet is not properly shut, it will be excluded from the testing by the alarm system.

If the alarm emits an acoustic signal even when the doors, bonnet and tailgate are correctly closed, a failure has occurred in system operation. Contact a Lancia Dealership.

IMPORTANT Centrally locking the doors using the metal insert on the key does not activate the alarm.

IMPORTANT The alarm is adapted to meet requirements in various countries.

TURNING THE ALARM OFF

Press button  on the key with the remote control. The following operations are performed (excluding some markets):

- the direction indicators flash briefly twice;
- two brief acoustic signals are emitted (“BEEP”);
- the doors are unlocked.

IMPORTANT Activating the central opening using the key’s metal insert does not turn the alarm off.

VOLUMETRIC/ANTI-LIFT PROTECTION

To guarantee the correct operation of the protection system it is advisable to shut all the side windows and the sun roof (for versions/markets where provided).

If necessary, the function can be turned off (if, for example, you are leaving an animal in the car) by pressing button A—fig. 18, located in the front courtesy light, before activating the alarm itself.

When the function is disabled, this is indicated by the LED on the button flashing for several seconds. Any disabling of the volume sensing/anti-lift protection must be repeated each time the instrument panel is switched off.

BREAK IN ATTEMPT INDICATION

Any break in attempt is indicated by the  warning light (or symbol in the display) lighting up, together with a message shown in the display (see “Instrument panel warning lights” paragraph).

DISABLING THE ALARM

To turn the alarm off completely (for example, if the vehicle is not being used for a long time) the vehicle must be closed by turning the metal insert in the key in the lock without using the remote control.

IMPORTANT If the battery of the key with the remote control runs out or the system fails, the alarm can be switched off by placing the key in the ignition switch and turning it to MAR.

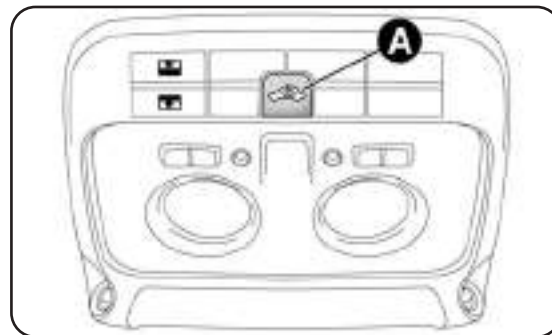

fig. 18



IGNITION SWITCH

The key can be turned to 3 different positions fig. 19:

- STOP: engine off, key can be removed, steering locked. Some electrical devices (e.g. sound system, central door locking system, etc.) can operate.
- MAR: driving position. All electrical devices can operate.
- AVV: engine starting.

The ignition switch is fitted with a safety system that requires the ignition key to be turned back to STOP if the engine does not start, before the starting operation can be repeated.

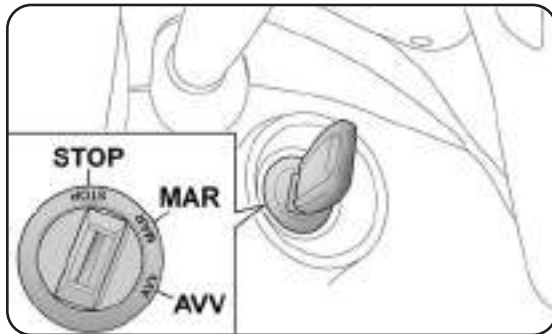

fig. 19

L0E0107.m

STEERING LOCK

Activation

When the key is at STOP, remove the key and turn the steering wheel until it locks.

Disengagement

Move the steering wheel slightly as you turn the ignition key to MAR.

IMPORTANT In some parking conditions (e.g.: wheels turned) the effort required to move the steering wheel and disengage the steering lock may be increased.



Never remove the key while the car is moving. The steering wheel will lock as soon as it is turned. This holds true for cars being towed as well. Under no circumstances should after-market operations be carried out involving steering system or steering column modifications (e.g. installation of anti-theft device). This could negatively affect performance and safety; invalidate the warranty; cause serious safety problems and also result in vehicle non-compliance with type-approval requirements.

SEATS



All adjustments on the front and rear seats must be made with the car stationary.



After releasing the adjustment levers always check that the seat is locked into place by trying to move it back and forth. If the seat is not locked into place, it may unexpectedly slide and cause the driver to lose control of the car.

FRONT SEATS fig. 20

Longitudinal adjustment

Lift the lever A and push the seat forwards or backwards: in the driving position your arms should rest on the rim of the steering wheel.

Backrest angle adjustment

Turn knob B.

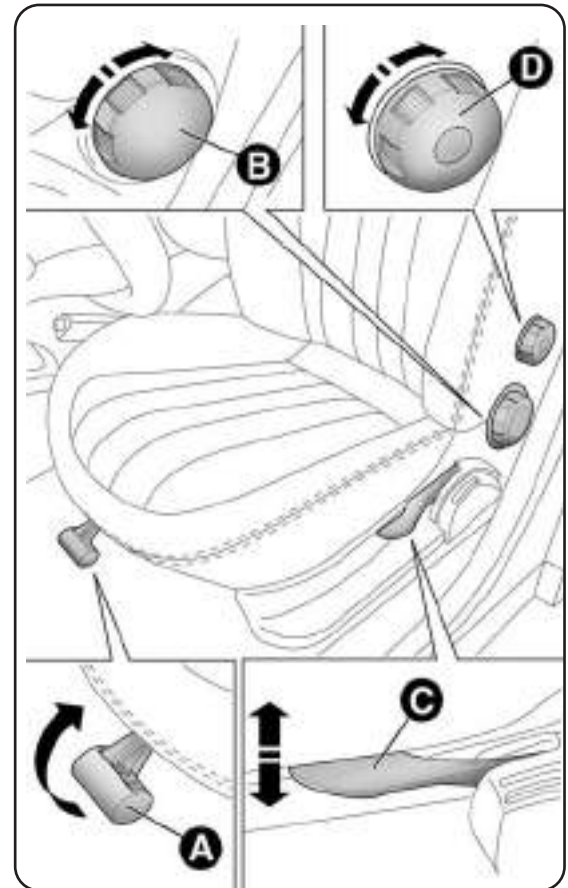

fig. 20



Height adjustment

Operate lever C to raise or lower the rear part of the seat cushion to improve comfort.

Lumbar adjustment (driver's seat)

The position of the back against the seat backrest is adjusted by turning knob D.

FRONT SEATS WITH ELECTRIC ADJUSTMENT

fig. 21 (for versions/markets where provided)

The adjustment is possible with the ignition key to MAR or for up to 1 minute with the ignition key turned to OFF or extracted.

When the front doors are opened the seat on the side of the door that has been opened can be moved for about 3 minutes or until the door is closed.

The controls for seat adjustment are:

Multifunction control A:

- seat height adjustment;
- lengthwise seat movement.

Multifunction control B:

- backrest angle adjustment;
- backrest lumbar adjustment.

Seat heating (for versions/markets, where provided)

With the key turned to MAR, press buttons  to switch the function on/off.

When the function is enabled, the LED on the button turns on.

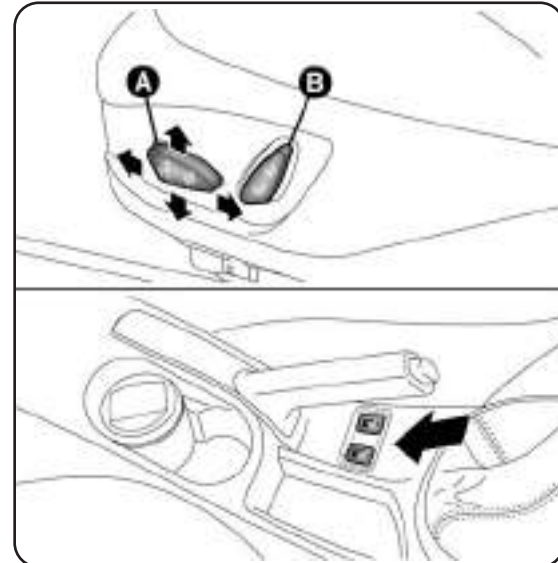

fig. 21

L0E0009m

REAR SEATS

Backrest angle adjustment

Lift lever A - fig. 22 (one on each side) for backrest angle adjustment, for the left or right part of the backrest respectively (to facilitate this operation, slightly move the seat forwards using lever B).

Rear seat movement

(for versions/markets, where provided)

The rear seats can be moved backwards and forwards (by 80 mm). To move the seats backwards or forwards operate the levers B (one on each side).

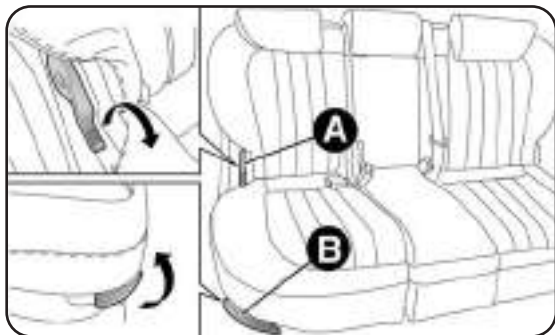

fig. 22

LOE0010m

“Fixed” type rear seats

(for versions/markets, where provided)

In some versions, rear seats are “fixed” type and the backrest angle adjustment is possible if the luggage compartment is extended. Use lever A-fig. 23 (one each side) for backrest angle adjustment.



When repositioning the rear backrest during its movement, check that it has been attached correctly; grasping the backrest at the top and shaking it.



Before tilting the backrests, make sure that the seat belts are fully stretched, without any twisting.

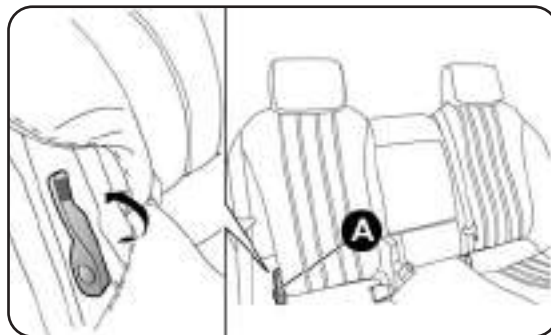

fig. 23

LOE0231m



HEAD RESTRAINTS

Head restraints are height adjustable; operate as follows.

- Upwards adjustment: lift the head restraint until it locks.
- Downward adjustment, press the button A and lower the head restraint.



All adjustments must be carried out only with the vehicle stationary and engine off. Head restraints must be adjusted so that the head, rather than the neck, rests on them. Only in this case can they protect your head correctly. To make the best use of the head restraint's protective action, adjust the backrest so that your torso is upright and keep your head as close as possible to the head restraint.

REAR HEAD RESTRAINTS fig. 24

(for versions/markets, where provided)

Depending on the versions, rear head restraints can be “fixed” or height-adjustable type.

Height-adjustable head restraint:

- Upwards adjustment: press button B and lift the head restraint until it locks.
- Downward adjustment, press button B and lower the head restraint.

To extract the rear head restraints press buttons B and C at the side of the two supports simultaneously and lift them out upwards.

IMPORTANT When the rear seats are in use, the head restraints must always be in the position of use.

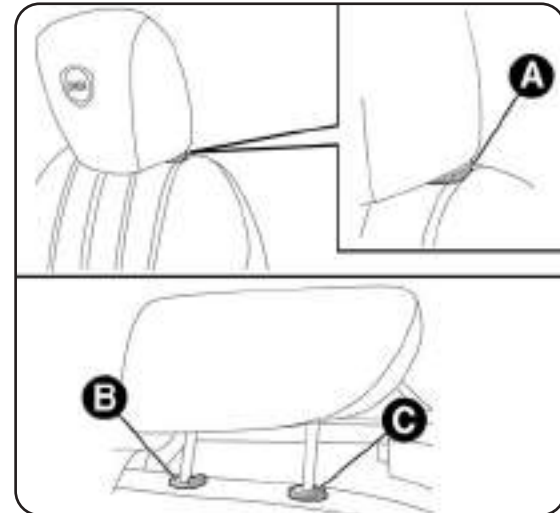

fig. 24

LOE0011m

STEERING WHEEL

It can be adjusted vertically (and axially).

To adjust the steering wheel, move the lever fig. 25 upwards to position 1. Adjust the steering wheel into the most suitable position and lock it in this position by moving the lever to position 2.



Any adjustments must be carried out only with the car stationary and engine off.

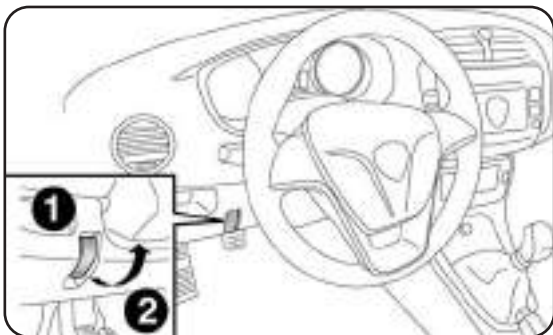

fig. 25

L0E0012m

REAR VIEW MIRRORS

INTERNAL REAR VIEW MIRROR fig. 26

The mirror is fitted with a safety device that causes its release in the event of a violent impact with the passenger.

Lever A can be used to move the mirror to two different positions: normal or antiglare.

INTERNAL ELECTROCHROMIC REAR VIEW MIRROR (for versions/markets, where provided)

Some versions have an electrochromic mirror with automatic antiglare function.

When reverse gear is engaged, the mirror is automatically set for daytime use.

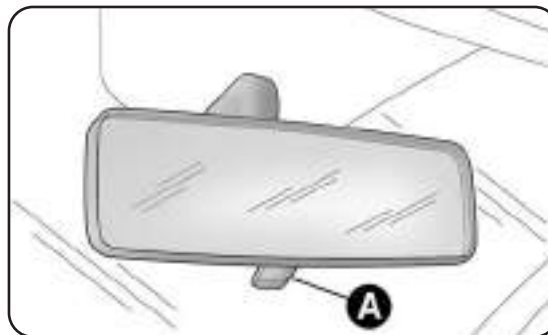

fig. 26

L0E0013m



DOOR MIRRORS

Mirror electric folding fig. 27

(for versions/markets, where provided)

Proceed as follows to adjust the position of the door mirrors:

- select the mirror using selector B;
- adjust the mirror using the controls A, in all four directions.

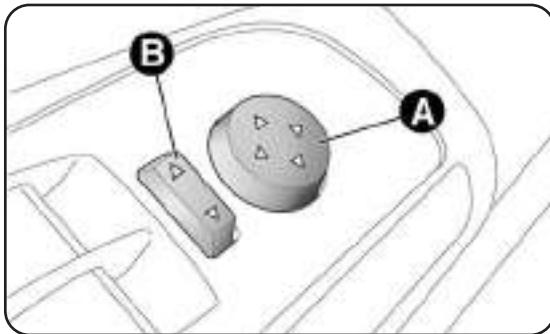

fig. 27

L0E0014m

Mirror manual folding fig. 28

When required (for example when the mirror causes difficulty in narrow spaces) it is possible to fold the mirror by moving it from position 1 (open), to position 2 (closed).

On some versions the door mirrors can be folded back electrically by operating a dedicated control.



When driving, the mirrors should always be in position 1. As the door mirrors are curved, they may slightly alter the perception of distance.

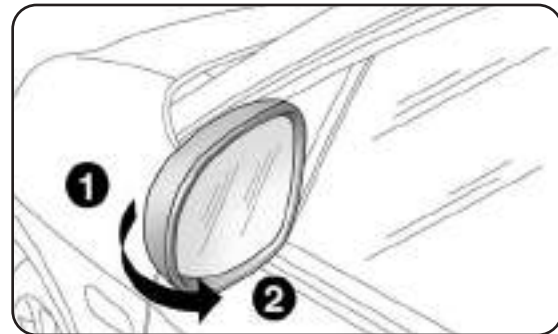

fig. 28

L0E0015m

CLIMATE COMFORT

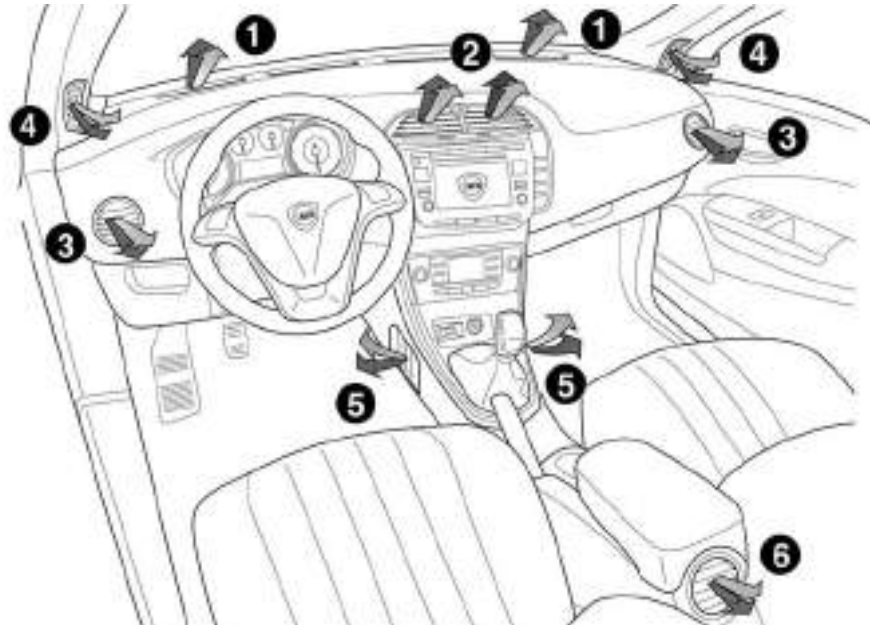

fig. 29

LOE0016m

DIFFUSERS fig. 29

1. Diffusers for windscreen defrosting or demisting – 2. Centre directable and adjustable diffusers – 3. Side directable and adjustable diffusers – 4. Fixed diffusers for side windows – 5. Lower diffusers – 6. Rear directable and adjustable vent (for versions/markets, where provided).



MANUAL CLIMATE CONTROL SYSTEM

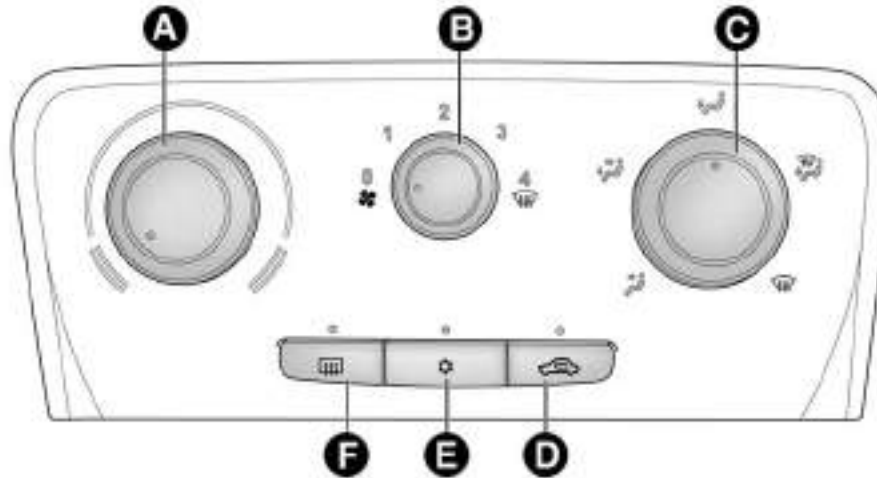

fig. 30

L0E0017m

CONTROLS fig. 30

- A. Air temperature knob (red = hot/blue = cold)
- B. Fan speed knob.
- C. Air distribution knob
 - ↙ toward the body and the side windows
 - ↙↘ toward the body, the side windows and the feet



- ↘ toward the feet only
- ↙↘ toward the feet and the windscreen
- ↗ toward the windshield only.

IMPORTANT It is advisable to activate air recirculation in queues or in tunnels to prevent the introduction of polluted air. However, it is better not to use the function for long periods, particularly if there are many people on board, to prevent the windows from misting.

- D. Air recirculation on/off button (LED lit up when function is on).
- E. Manual climate control compressor on/off button (LED lit up when function is on).
- F. Heated rear window activation/deactivation button. When the function is active, an LED on the button is lit up. In order to maintain battery efficiency, the function is automatically deactivated after about 20 minutes.

FAST WINDSCREEN AND FRONT SIDE WINDOW DEMISTING/DEFROSTING (MAX-DEF)

Proceed as follows:

- turn knob A to the red section;
- turn knob C to ;
- turn knob D to ;
- turn knob B to 4  (maximum fan speed).

IMPORTANT The climate control system is very useful for fast demisting because it dries the air. Adjust the controls as described above and press knob B to switch the climate control system on: the LED on the knob will light up.

SYSTEM SERVICING

In winter, the climate control system must be turned on at least once a month for about 10 minutes. Have the system inspected at a Lancia Dealership before the summer.



DUAL-ZONE AUTOMATIC CLIMATE CONTROL SYSTEM

(for versions/markets, where provided)

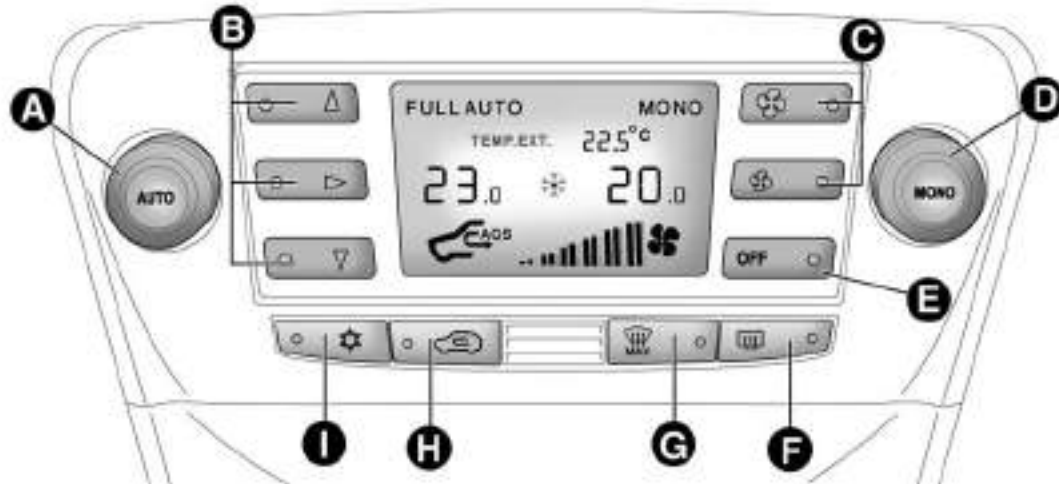

fig. 31

LOE001Sm

The vehicle may be equipped with a dual zone automatic climate control system, fig. 31, which regulates the passenger side air temperature separately from the driver's side.

The system is equipped with an AQS (Air Quality System) (for versions/markets, where provided) function, which automatically switches on the air recirculation system if the outside air is polluted (e.g. in traffic queues and tunnels).

SWITCHING ON THE CLIMATE CONTROL SYSTEM

The system can be activated by pressing any of the buttons; it is, however, advisable to set the desired temperatures on the display, then press the AUTO button.

The climate control system allows you to customise the temperatures requested (driver side and passenger side) with a maximum difference of 7°C.

The climate control system compressor only works with the engine running and with an outside temperature above 4°C.

Automatic climate control operation (AUTO function) A - fig. 31

Press the AUTO button; the system will automatically adjust:

- the amount of air introduced into the passenger compartment;
- the distribution of air inside the passenger compartment;

cancelling any previous manual settings.

During climate control system automatic operation, the words FULL AUTO appear on the display.

During automatic operation it is still possible to adjust the temperatures set and carry out one of the following operations manually:

- adjust fan speed;
- select air distribution;
- switch internal air recirculation and AQS function on/off (for versions/markets, where provided);
- switch on the climate control system compressor.



It is advisable not to use the internal air recirculation function when the outside temperature is low to prevent the windows from rapidly misting up.



Selecting air distribution B - fig. 31

Press one or more of buttons ▲ / ▼ / ► to manually select one of the 7 possible air distribution settings for the passenger compartment:

- ▲ Air flow to the windscreen and front side window diffusers to demist/defrost them.
- ▼ Air flow to the front and rear footwell diffusers. This air distribution allows the passenger compartment to be warmed up quickly.
- ▲ Air flow distribution between the front and rear diffusers, centre/side dashboard
- ▼ diffusers, rear diffuser and windscreen and front side window demisting/defrosting diffusers.
- ▲ Air flow distribution between the footwell
- ▼ diffusers and the windscreen and front side window demisting/defrosting diffusers. This distribution setting allows the passenger compartment to be warmed up efficiently and prevents the windows from misting up.
- Air flow distribution between footwell diffusers (hotter air) and centre/side dashboard diffusers and rear diffuser (cooler air).

- Air flow distribution between centre/side dashboard diffusers, rear diffuser and windscreen and front side window demisting/defrosting diffusers. This distribution setting ventilates the passenger compartment well and prevents the windows from misting up.

IMPORTANT For the climate control system to function, at least one of the following buttons must be on: ▲ / ▼ / ►. The system does not allow all the buttons ▲ / ▼ / ► to be switched off.

IMPORTANT Push the OFF button to turn the climate control system back on; in this way, all operating conditions saved before switching off are restored.

To restore automatic control of the air distribution after a manual selection, press the AUTO button.

Adjusting the fan speed fig. 31

Operate buttons C  to increase/decrease the speed of the fan.

The 12 possible speeds are indicated by bars lighting up on the display:

- max fan speed = all bars lit
- min. fan speed = one bar lit.

The fan can be disabled (no bars lit) only if the climate control compressor has been switched off by pressing button .

To restore automatic fan speed control after a manual adjustment, press AUTO.

Aligning the set temperatures (MONO function) fig. 31

Press button D (MONO) to align the temperature between the driver side and passenger side.

Then turn the AUTO or MONO knob to increase/decrease the temperature between the two areas by the same amount.

Press MONO again to deactivate the function.

Switching off the climate control system fig. 31

Press button E (OFF).

The following information is shown on the display:

- the word OFF;
- outside temperature reading;
- indication that air recirculation is switched on (LED on button  is lit).



Heated rear window and door mirrors demisting/defrosting fig. 31

Press button F  to activate; when this function is activated, the button LED lights up.

This function is timed and will turn off automatically after 20 minutes. Press the button  again to switch the function off.



IMPORTANT Do not apply stickers on the inside of the rear window over the heating filaments to avoid damage.

IMPORTANT Press  to introduce air from the outside (in this case the LED on the button is off).

Rapid front window demisting/defrosting (MAX-DEF function) fig. 31

Press button G  to automatically activate the timed operation of all the functions required to rapidly demist/defrost the windscreen and front side windows.

The functions are:



- climate control compressor engagement (with an outside temperature of above 4°C);
- switching off, if previously on, of the interior air recirculation (LED on button  off);
- switching on of heated rear window (LED on button  on) and door mirror heater coils;
- air temperature set to maximum;
- activation of air flow.



Activation of air recirculation and enablement of AQS (Air Quality System)

(for versions/markets, where provided) **fig. 31**

Press button .

Internal air recirculation is carried out according to three possible operating modes:

- automatic control, signalled by the AQS sign on the display and the LED on button  being off;
- permanently off (air recirculation always off with introduction of external air), indicated by the LED on button  being off;
- permanently on (air recirculation always on), signalled by the LED on button  being lit up.

When OFF is pressed, the climate control system automatically activates internal air recirculation (LED on button  on). It is still possible to activate outside air recirculation (LED on the button off) and vice versa, by pressing button .

With the OFF button pressed (LED on the button is lit up), it is not possible to enable the AQS (Air Quality System) function.

IMPORTANT The internal air recirculation system makes it possible to reach the required heating or cooling conditions faster depending on the mode selected. It is not advisable to switch the air recirculation on when it is rainy/cold to prevent the windows from misting up, especially if the climate control is not turned on. It is advisable to switch the internal air recirculation on whilst queuing or in tunnels to prevent the introduction of polluted air. Do not use the function for a long time, particularly if there are several passengers on board, to prevent the windows from misting up.

Enabling the AQS (Air Quality System) function

(for versions/markets, where provided)

The AQS function (AQS appears on the display), automatically activates internal air recirculation when the outside air is polluted (e.g. in traffic queues and tunnels).



IMPORTANT With the AQS function active, after 15 consecutive minutes of the internal air recirculation system functioning, the climate control system enables the intake of outside air for approximately 1 minute to freshen the air in the passenger compartment. This takes place regardless of the pollution level of the outside air.





Switching the climate control compressor on/off I - fig. 31

Press button  to switch on the climate control system compressor.

Compressor engagement

- the LED on button  is lit up;
- symbol  is shown on the display.

Compressor off

- the LED on button  is off;
- symbol  off on the display;
- internal air recirculation is excluded;
- the AQS function is disabled.



With the climate control compressor switched off, air cannot be introduced into the passenger compartment at a lower temperature than the outside temperature; in this case the  symbol on the display will flash.

The deactivation of the climate control compressor is memorised even after the engine has stopped. To turn the climate control compressor back on, press button  again or press AUTO: if you press AUTO, the other manual settings will be cancelled.

EXTERNAL LIGHTS

The left stalk fig. 32 operates most of the external lights. The ignition key has to be in the MAR position for the exterior lights to come on. The instrument panel and the various dashboard controls will come on with the external lights.

DAYTIME RUNNING LIGHTS (DRL) (for versions/markets where provided)

With the ignition key turned to MAR and the twist switch turned to position  the daytime running lights are automatically activated; the other lights and interior lighting remain off. The automatic operation of the daytime running lights can be activated/deactivated via the display menu (see “Display” paragraph in this chapter). If the daytime running lights are deactivated, no light comes on when the twist switch is turned to .

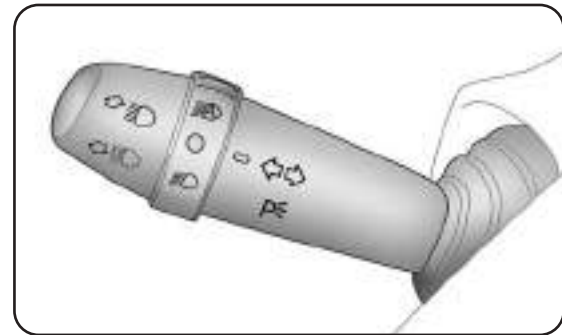

fig. 32

L0E0019m



The daytime running lights are an alternative to the dipped beam headlights for driving during the daytime in countries where it is compulsory to have lights on during the day, and they are also permitted in those countries where this is not obligatory.

Daytime running lights cannot replace dipped beam headlights when driving at night or through tunnels. The use of daytime running lights is governed by the highway code of the country in which you are driving. Comply with the prescriptions.

AUTOMATIC HEADLIGHT SENSOR (dusk sensor) (for versions/markets, where provided)

It detects variations in brightness outside the vehicle depending on the light setting: the greater the sensitivity, the less outside light needed to activate the exterior lights being turned on. The sensitivity of the dusk sensor may be adjusted, using the “Setup menu” on the instrument panel.

Activation

When the ring nut is turned to the AUTO position the external lights automatically switch on depending on the exterior brightness.

The headlights can only be flashed with the sensor on.

Deactivation

When the lights are switched off by the sensor, the dipped beam headlights and side lights are switched off and the day lights are switched on (if activated).

The sensor is not capable of detecting the presence of fog therefore, in these circumstances, the lights have to be turned on manually.

FRONT FOG LIGHTS WITH CORNERING LIGHTS FUNCTION

When the dipped beam headlights are on and the speed is below 40 km/h, if the steering wheel rotation angle is large or the direction indicators are on, a light (incorporated in the fog light) will come on on the relevant side to improve visibility at night time. The function can be activated/deactivated via the display menu (see “Display” paragraph in this chapter).



DIPPED BEAM HEADLIGHTS/SIDE LIGHTS

With the ignition key turned to MAR, turn the twist switch to . If the dipped beam headlights are activated, the daytime running lights are switched off and the side lights, dipped beam headlights and number plate lights are switched on. The warning light on the instrument panel comes on. When the ignition key is turned to STOP or removed and the twist switch is turned from to , all the side lights and number plate lights come on. The warning light in the instrument panel comes on.

Parking function

With the side lights on and the ignition key in the OFF position or extracted, it is possible to select the lighting on the desired side by operating the lights lever downwards (left side) or upwards (right side). In this case the warning light in the instrument panel will go out.

MAIN BEAM HEADLIGHTS

With twist switch in position , push the stalk forward toward the dashboard (stable position). The warning light on the instrument panel will come on. They are switched off by pulling the lever towards the steering wheel.

Flashing

You can flash the beams pulling the stalk toward the steering wheel (unstable position). The warning light on the instrument panel will come on.

DIRECTION INDICATORS fig. 33

Bring the stalk to the (stable) position:

- up (position **1**): activates the right direction indicator;
- down (position **2**): activates the left direction indicator.

The or warning light starts flashing on the instrument panel. The direction indicators switch off automatically when the steering wheel is straightened.

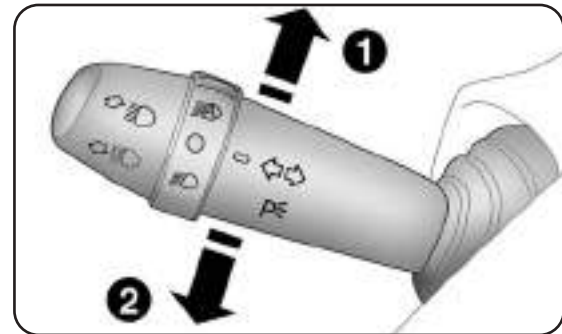

fig. 33

L0E0020m

LANE CHANGE FUNCTION

If you wish to signal a lane change, place the left stalk in the unstable position for less than half a second. The direction indicator on the side selected will flash five times and then switch off automatically.

“FOLLOW ME HOME” DEVICE

This allows the space surrounding the car to be lit up for a certain period of time.

Activation

With the ignition key in the STOP position or extracted, pull the stalk towards the steering wheel and move it within 2 minutes of the engine switching off. Each time the stalk is moved, the lights stay on for an extra 30 seconds up to a maximum of 210 seconds; then the lights are switched off automatically. Each time the lever is operated, the warning light 3 on the instrument panel comes on and the display shows how long the function will remain active. The warning light comes on when the stalk is pulled for the first time and stays lit until the function switches itself off automatically. Each time the stalk is activated it increases the time that the lights remain on.

Deactivation

Keep the stalk pulled towards the steering wheel for more than two seconds.

WINDOW CLEANING

The right-hand lever fig. 34 controls windscreen wiper/washer and rear window wiper/washer operation.

WINDSCREEN WIPER/WASHER

This operates only with the ignition key turned to MAR.

The right hand lever can take up five different positions:

A: windscreen wiper off.

B: intermittent operation.

With the stalk in position B, turn ring nut F to select one of four different speeds for the intermittent operation mode:

 = very slow intermittent operation

■ = slow intermittent operation.

■ ■ = normal intermittent operation

■ ■ ■ = fast intermittent operation.

C: continuous slow operation;

D: continuous fast operation;

E: temporary fast operation (unstable position).



“Smart washing” function

Pull the stalk towards the steering wheel (unstable position) to operate the windscreen washer. Keep the lever pulled to activate both the windscreen washer jet and the windscreen wiper with a single movement; the latter turns on automatically if you keep the lever pulled for more than half a second. The windscreen wiper stops operating a few strokes after releasing the stalk; a further “cleaning stroke”, after a few seconds, completes the wiping operation.

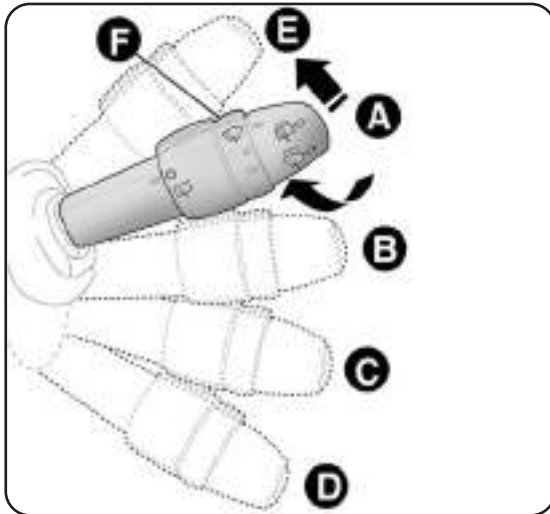

fig. 34

L0E0021m

REAR WINDOW WASHER/WIPER

This operates only with the ignition key turned to MAR. Turn the ring nut to ‘ to operate the rear window wiper. With the windscreen wiper on, turn the ring nut to □ to turn on the rear window wiper. In this case the wiper works (in the different positions) timed with the windscreen wiper, but at half speed. With the windscreen wiper on, engaging reverse gear will automatically turn the rear window wiper on, in continuous slow operation. Operation stops when reverse is disengaged.



Do not use the windscreen or rear window wiper to remove layers of snow or ice from the windscreen. In such conditions, the wiper may be subjected to excessive stress and the motor protection, which prevents operation for a few seconds, may intervene. If rear window wiper operation is not reset, contact a Lancia Dealership.

“Smart washing” function

Pushing the stalk towards the dashboard (unstable position) will activate the rear window washer. Keep the stalk pressed, with just one movement, to operate the rear window washer jet and the rear window wiper itself; the latter automatically turns on if you keep the stalk pressed for more than half a second.

The rear window wiper stops operating a few strokes after releasing the stalk; a further “cleaning stroke”, after a few seconds, completes the wiping operation.

RAIN SENSOR

(for versions/markets where provided)

The rain sensor A - fig. 35 is located behind the internal rear view mirror in contact with the windscreen and automatically adjusts the frequency of the windscreen wiper strokes according to the rain intensity during intermittent operation.

The sensor has an adjustment range that varies progressively from wiper still (no stroke) when the windscreen is dry, to wiper at first continuous speed (slow continuous operation) with intense rain.

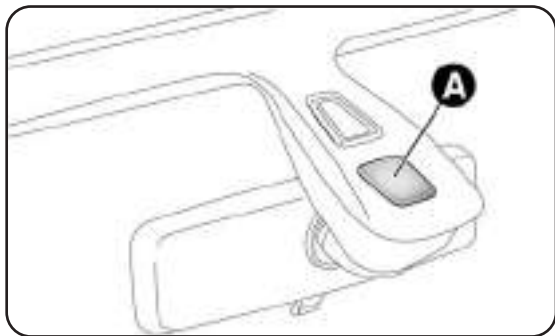

fig. 35

LOE0023m

Activation

Move the right lever down by one click.

The activation of the sensor is signalled by a “stroke” to show that the command has been acquired.

IMPORTANT Keep the glass in the sensor area clean.

By turning ring nut F - fig. 34 it is possible to increase the sensitivity of the rain sensor to obtain a more rapid variation between wiper still (no stroke) when the windscreen is dry, to wiper at first continuous speed (slow continuous operation).

The increasing of the rain sensor sensitivity is signalled by a “stroke” to show that the command has been acquired. Activating the windscreen washers with the rain sensor activated produces the normal washing cycle at the end of which the rain sensor resumes its normal automatic operation.



Deactivation

Turn the ignition key to STOP.

The next time the vehicle is started (ignition key turned to MAR), the sensor is not reactivated even if the lever is still in position B - fig. 34. To activate the sensor, move the lever to position A or C and then back to position B. Rain sensor activation will be indicated by at least one wiper "stroke" even if the windscreen is dry.



Do not activate the rain sensor when washing the car in an automatic car wash.



Make sure the device is switched off if there is ice on the windscreen.



Make sure the device is switched off whenever the windscreen is being cleaned.

CRUISE CONTROL (constant speed regulator)

(for versions/markets, where provided)

This is an electronically controlled driving assistance device which allows the vehicle to be driven at a chosen speed above 30 km/h on long stretches of dry, straight roads with few variations (e.g. motorways), without having to depress the accelerator pedal.

It is therefore not recommended to use this device on extra-urban roads with traffic. Do not use it in town.

ACTIVATING THE DEVICE

Turn selector wheel A - fig. 36 to ON.

The device must only be switched on in gears higher than 4th.

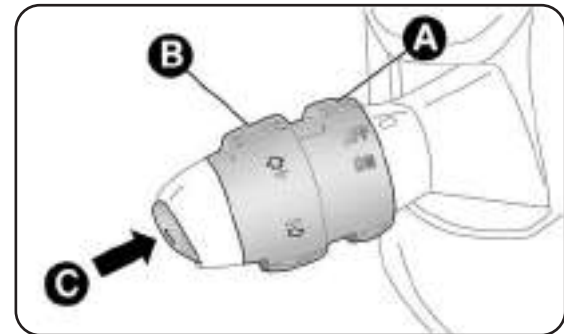



fig. 36

LOE0022m

When travelling downhill with the device engaged, the vehicle speed may slightly exceed the preset one.

The engagement of the device is signalled by the  warning light coming on in the instrument panel (together with a message shown on the display) (see “Instrument panel warning lights” paragraph).

STORING THE CAR SPEED

Proceed as follows:

- turn the ring nut A - fig. 36 to ON and press the accelerator pedal until the vehicle reaches the desired speed;
- turn the ring nut to (+) for at least three seconds, then release it. The vehicle speed is now memorised and you can therefore release the accelerator pedal.

If needed (when overtaking for instance), you can accelerate simply by pressing the accelerator pedal; when you release the pedal, the car will return to the speed memorised previously.

RESTORING THE MEMORISED SPEED

If the device has been switched off, for example by depressing the brake or clutch pedal, the memorised speed can be restored as follows:

- accelerate gradually until reaching a speed approaching the memorised speed;

- engage the gear selected at the time of speed memorising (fourth, fifth or sixth gear);
- press button C - fig. 36.

INCREASING THE MEMORISED SPEED

This can be done in two ways:

- by pressing the accelerator and then memorising the new speed reached;

or

- by temporarily turning ring nut B - fig. 36 to (+).

Each movement of the selector wheel will correspond to a slight increase in speed (about 1 km/h), while keeping the selector wheel turned will correspond to a continuous speed increase.

REDUCING THE MEMORISED SPEED

This can be done in two ways:

- by disengaging the device and then memorising the new speed;

or

- by keeping ring nut B - fig. 36 turned to (–) until the new speed is reached; it will then be memorised automatically.

Each movement of the ring nut will correspond to a reduction in speed of about 1 km/h, while keeping the ring nut turned will correspond to a continuous reduction in speed.



DEACTIVATING THE DEVICE

Turn the ring nut A - fig. 36 to OFF or turn the ignition key to STOP. The device is automatically turned off in one of the following cases:

- when the brake or clutch pedal is pressed;
- if the ASR or Advanced ESP system cuts in (for versions/markets where provided);



While travelling with the device engaged, do not place the gear lever in neutral.



In case of malfunction or if the device is faulty; turn the control A - fig. 36 to OFF and contact a Lancia Dealership, after checking that the protective fuse has not blown.

ROOF LIGHTS

FRONT ROOF LIGHT WITH SPOT LIGHTS fig. 37

Switch A is used to switch on/off roof lights.

With the switch A in the middle position, the lights C and D go on/off when front doors are opened/closed.

With switch A pressed to the left, the lights C and D are always off. With switch A pressed to the right, the lights C and D are always on.

Lights switch on/off progressively.

Switch B controls the spot light function; when the roof light is off, it switches on individually:

- the light C when pressed to the left;
- the light D when pressed to the right.

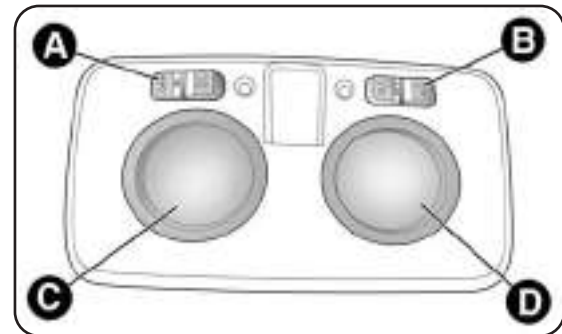

fig. 37

L0E0024m

For versions/markets, where provided the roof light, some bulbs light the car interior when the main beam headlights or dipped beam headlights are on.

IMPORTANT The roof light, for some versions, may also be in a rear central position (electric sun roof version).

IMPORTANT Before getting out of the car, make sure both switches are in the middle position; when the doors are closed, the lights switch off preventing a possible discharge of the battery. In any case, if the switch is left in on position, the roof light switches off automatically 15 minutes after the engine switching off.

Roof light timing

To make getting in and out the vehicle easier, especially at night time or in poorly lit areas, two timing logic are available.

Timing while getting into the vehicle

The roof lights switch on according to the following modes:

- for around 10 seconds when the front doors are unlocked;
- for about 3 minutes when one of the side doors is opened;
- for about 10 seconds when the doors are closed.

The timed period is interrupted when the ignition is turned to “MAR”.

Timing while getting out of the vehicle

After removing the key from the ignition, the roof lights switch on according to the following modes:

- within 2 minutes of the engine being switched off for a period of about 10 seconds;
- when one of the side doors is opened for a period of about 3 minutes;
- when one of the doors is closed for a period of about 10 seconds.
- if the fuel cut off switch operates, they remain on for about 15 minutes, then they switch off automatically.

Door locking switches the lights off immediately (unless the fuel cut-off switch is operating).

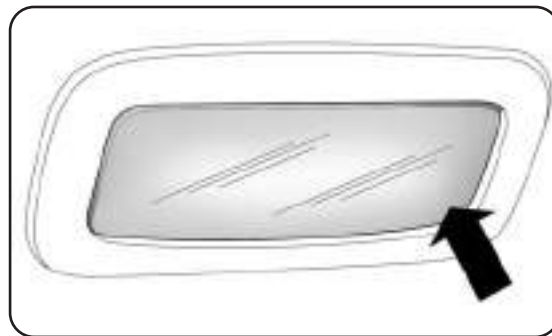

fig. 38



REAR ROOF LIGHT fig. 38

Press the point indicated by the arrow to switch the lights on/off (+ sign on the roof light lens cover).
The rear roof lights also come on in conjunction with events that cause the front roof light to come on.

LUGGAGE COMPARTMENT LIGHT fig. 39

This light comes on automatically when the luggage compartment is opened and switches off when it is closed.

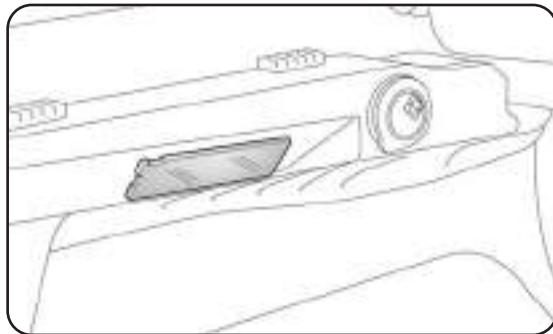

fig. 39

L0E0026m

CONTROLS

DUALDRIVE ELECTRIC POWER STEERING SYSTEM fig. 40

Press button A to turn the CITY function on (see “Electric power steering” paragraph). When this function is on, the wording CITY on the instrument panel will turn on. Press the button again to turn the function off.

SPORT FUNCTION CONTROL fig. 40
(for versions/markets, where provided)

Press button B to activate the sports driving setting. This features more responsive acceleration and increased force required at the steering wheel to produce a more sporty feel.

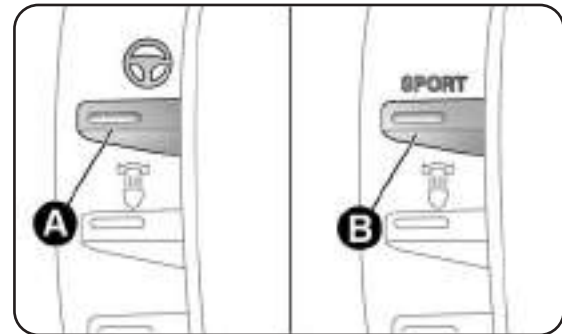

fig. 40

L0E0027m

When this function is on (see “SPORT function”), the word SPORT is lit up in the display. Press the button again to turn the function off and restore the normal driving setting.



On some versions, with the CITY function activated, the SPORT function is not available. To activate the SPORT function, deactivate the CITY function and vice versa, because they are reciprocally incompatible.

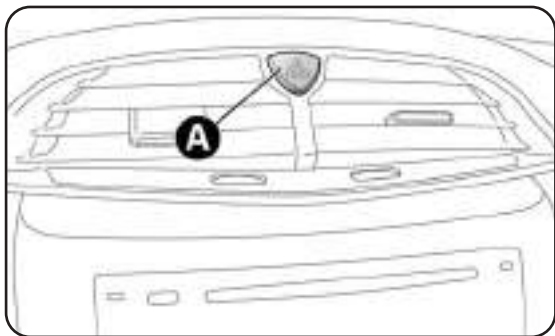





fig. 41

LOE002Sm

HAZARD WARNING LIGHTS fig. 41

These lights are switched on by pressing button A, regardless of the position of the ignition key. With the device on,  and  warning lights light up in the instrument panel. To switch off the lights, press button A again. The use of hazard warning lights is governed by the highway code of the country you are in. Comply with legal requirements.

Emergency braking

During emergency braking, the hazard warning lights come on automatically and lights  and  on the panel come on at the same time. The function switches off automatically when the nature of the braking changes. This function complies with the relevant legislation currently in force.



FRONT FOG LIGHTS fig. 42

(for versions/markets, where provided)

Press button A to activate the front fog lights. When the front fog lights are activated the ☞ warning light is lit up in the instrument panel. The front fog lights are activated when the dipped headlights are on.

REAR FOG LIGHTS fig. 42

To turn the lights on press the button B with the dipped beam headlights on. With lights on, the ☞ warning light on the instrument panel will switch on. Press the button again to switch the lights off.

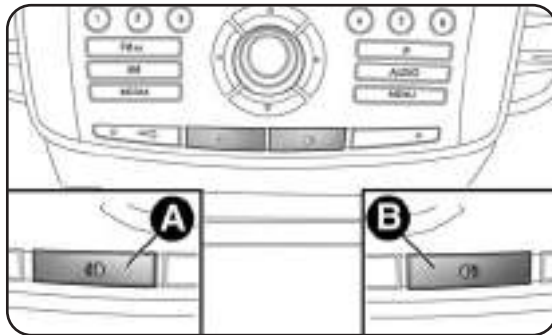

fig. 42

L0E0029m

AFS ADAPTIVE LIGHTS

(Adaptive Xenon Lights) fig. 43

The adaptive lights (see “Headlights” paragraph in this chapter) are activated automatically when the car is started. In this situation the LED (amber) on button A will remain off.

Press button A to deactivate the adaptive lights (if activated); they will be deactivated and the LED on button A will come on constantly. Press AFS button again to turn the adaptive lights on (LED off on the button).

In the event of a system failure, an indication is provided on the instrument panel by the flashing of the ☞ warning light or the ☞ symbol appearing on the display along with a dedicated message (for versions/markets where provided).

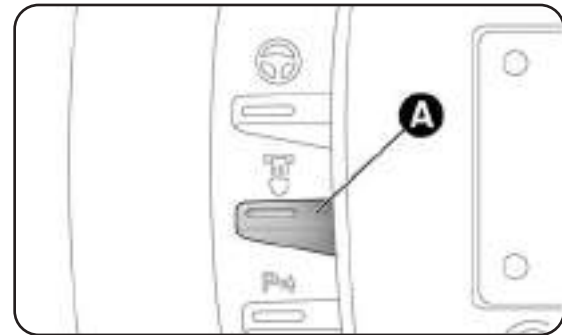

fig. 43

L0E0030m

FUEL CUT-OFF SYSTEM

This intervenes in the case of an impact causing:

- cut off of fuel supply with resultant engine shut down;
- automatic door lock release;
- activation of all lights inside the car.

The intervention of the system is indicated by a message shown on the display.

Carefully check the car for fuel leaks, for instance in the engine compartment, under the car or near the tank area. Following a collision, turn the ignition key to STOP to avoid draining the battery.

To restore correct car operation, follow this procedure:

- turn the ignition key to MAR;
- activate the right hand indicator;
- deactivate the right hand indicator;
- activate the left hand indicator;
- deactivate the left hand indicator;
- activate the right hand indicator;
- deactivate the right hand indicator;
- activate the left hand indicator;
- deactivate the left hand indicator;
- turn the key to STOP;
- turn the ignition key to MAR.



If, after a crash, you smell fuel or notice leaks from the fuel supply system, do not reset the system to avoid the risk of fire.



INTERIOR FITTINGS

SUN VISORS **fig. 44**

They are located at the sides of the interior rear view mirror.

They can be adjusted forwards and sideways.

A mirror is provided on the back of the sun visors.

This is illuminated by roof light A. The driver and passenger-side sun visors also feature a document holder.

IMPORTANT On both sides of the passenger side sun visor there is a label remembering that it is compulsory to deactivate the airbags if a rearward facing child restraint system is fitted. Always comply with the instructions on the label (see the “Front Airbags” paragraph in chapter “Safety”).

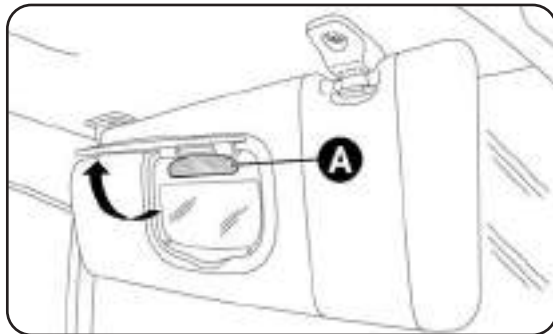

fig. 44

L0E0032m

FRONT ARMREST WITH STORAGE COMPARTMENTS

This is located between the front seats. A storage compartment and cooled drinks compartment are located inside the armrest (for versions/markets, where provided) (see following paragraphs). The armrest can be moved backwards and forwards by operating the cover A - fig. 45.

Storage compartment

Lift up cover A - fig. 45: you can thus access the storage compartment B.

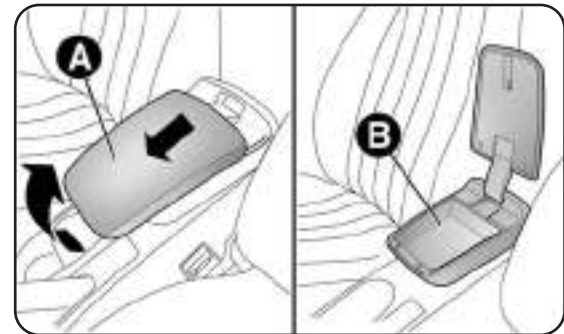

fig. 45

L0E0033m

Cooled drinks compartment

(for versions/markets, where provided)

Press button A - fig. 46 and lift up armrest B: you can then access the cooled drinks compartment fig. 46.

IMPORTANT The function of the compartment is to maintain the temperature of the drinks that are put in which should be heated or cooled beforehand. The drinks will remain hot if the heater is switched on or cool if the compressor is switched on.

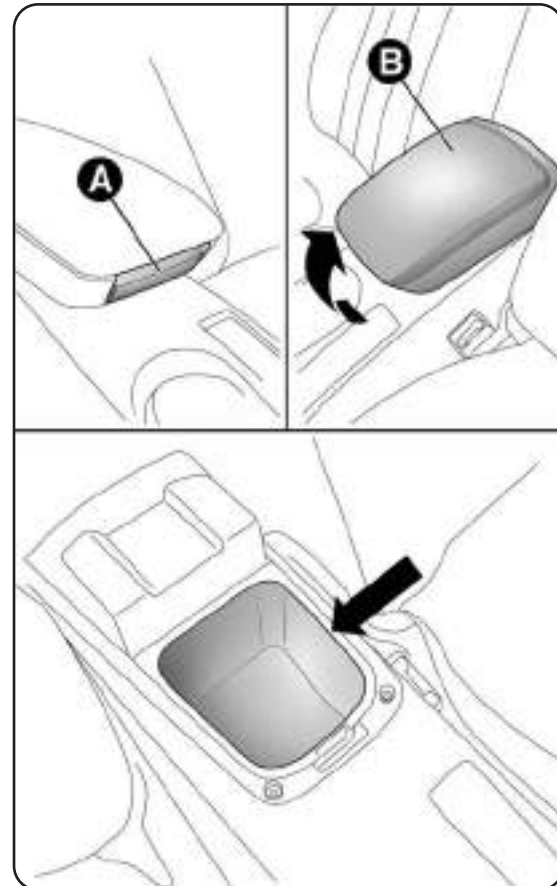

fig. 46



REAR ARMREST

(for versions/markets, where provided)

To use the armrest A - fig. 47 lower it as shown in the figure (for this operation the central head restraint must be “all up”).

There are two compartments B in the armrest for housing glasses and/or cans.

To use these, pull C tab in the direction shown by the arrow.

A storage compartment is available inside the armrest; this can be accessed by raising the flap.

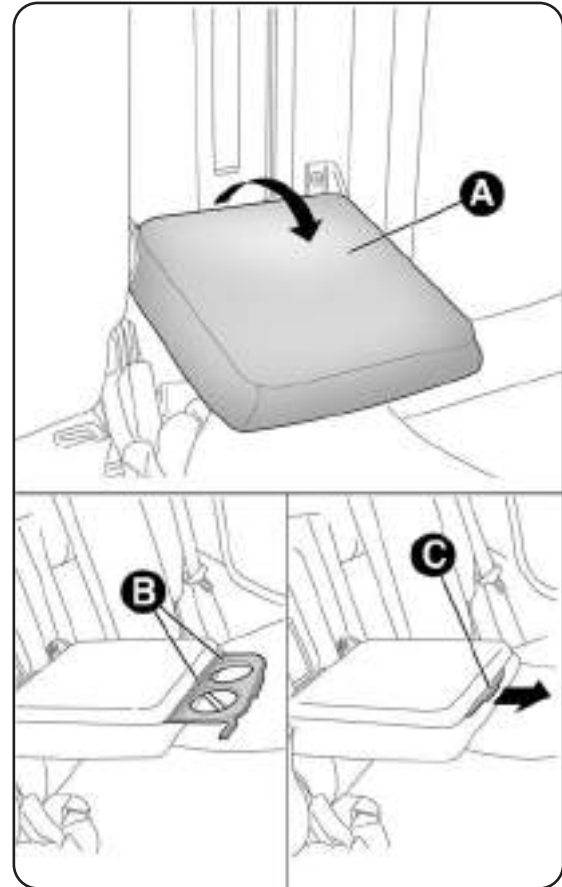

fig. 47

L0E0035m

GLOVE COMPARTMENT

To open the glove compartment, operate handle A - fig. 48. When the compartment is opened a courtesy light comes on inside, which remains on for about 15 minutes, with the ignition in the STOP position.

If, during this period, a door or the tailgate is opened, the 15 minute timing is reset.



Never travel with the glove compartment open: it could injure the passenger in the event of a crash.

CUP/BOTTLE HOLDERS fig. 49

The centre tunnel has two cup/bottle holders.

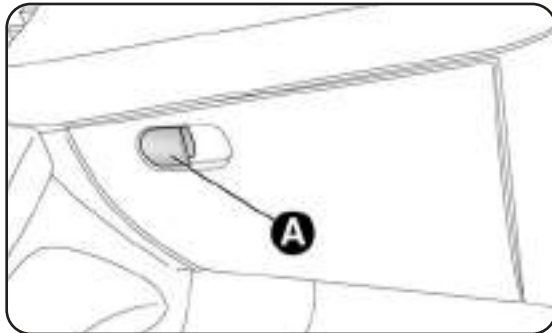

fig. 48

LOE0037m

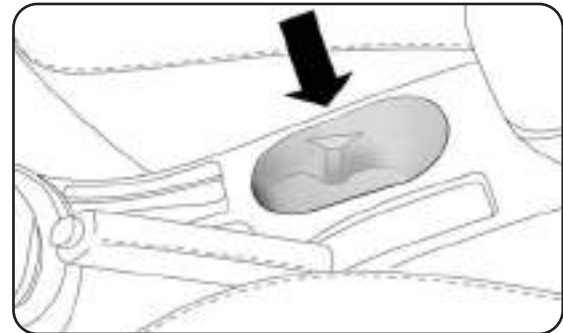

fig. 49

LOE003Sm



POWER SOCKET (12 V)

(for versions/markets, where provided)

Power socket A - fig. 50 is located on the centre tunnel and is only operational when the ignition key is turned to MAR. If a smokers kit is requested, the socket is replaced by a cigar lighter.

On some versions an additional power socket B is provided in the luggage compartment.



Only accessories with a maximum power of 180 W (maximum absorption 15A) can be connected to the socket.

CIGAR LIGHTER

(for versions/markets, where provided)

This is located on the central tunnel.

To turn the cigar lighter on, press button A - fig.51 with the ignition in the MAR position.

After a few seconds the button goes back to its initial position and the cigar lighter is ready for use.

IMPORTANT Always make sure the cigar lighter is switched off.

IMPORTANT The cigar lighter gets very hot. Handle it carefully and make sure that children don't touch it: risk of fire and/or burning.

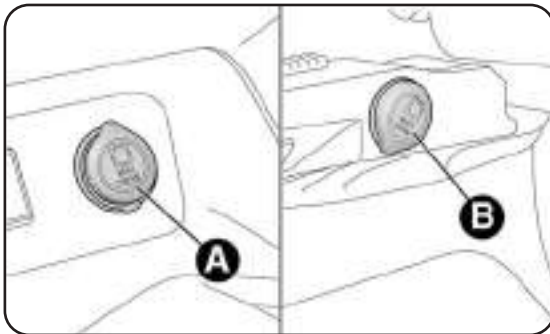

fig. 50

LOE0039m

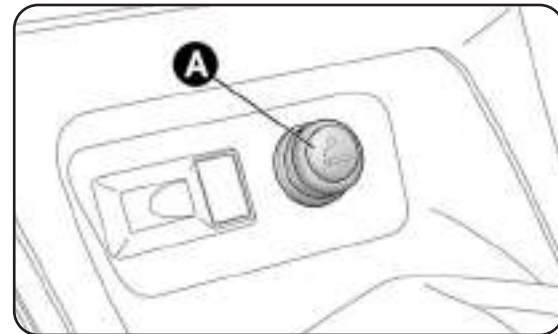

fig. 51

LOE0040m

ASHTRAY

This is a plastic container fig. 52 that can be extracted with a spring action and placed in the cup/can holder in the centre tunnel.

IMPORTANT Do not use the ashtray as a waste paper basket: it might catch fire in contact with cigarette stubs.

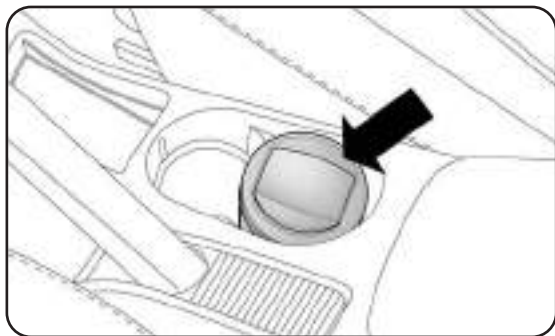

fig. 52

LOE0041m

SUNROOF

(for versions/markets, where provided)

The large electric sun roof comprises two glass panels; the front one is mobile and the rear one fixed. These are equipped with two sun blinds (front and rear) that can be moved manually. With the sun roof closed, the blinds can be placed in any position. To open the blinds: grip handle C - fig. 53, and move the blind to the required position by following the direction of movement shown by the arrow. To close them, carry out the procedure in reverse. The sun roof can be operated only with the ignition key turned to MAR. The controls A-B fig. 53 on the front courtesy light trim operate the roof opening/closing functions.

Opening

Press and hold down button B - fig. 53. The front glass panel will move into the spoiler position; press button B once again and hold down for more than half a second to automatically move the sun roof to an intermediate position ("Comfort" position). If the opening control is pressed again for more than half a second, the roof will automatically continue until it reaches the end of travel position; the roof glass can be stopped in an intermediate position by operating the button again.

IMPORTANT During the sun roof opening operation, the blind will follow the movement of the sun roof.



Closing

With the roof in the fully open position, press button A - fig. 53 and, if the button is operated for more than half a second, the front roof glass will automatically assume the intermediate position (comfort position). If the button is operated again for about half a second the roof will assume the spoiler position. Lastly, if the closing button is pressed again, the roof will assume the fully closed position.

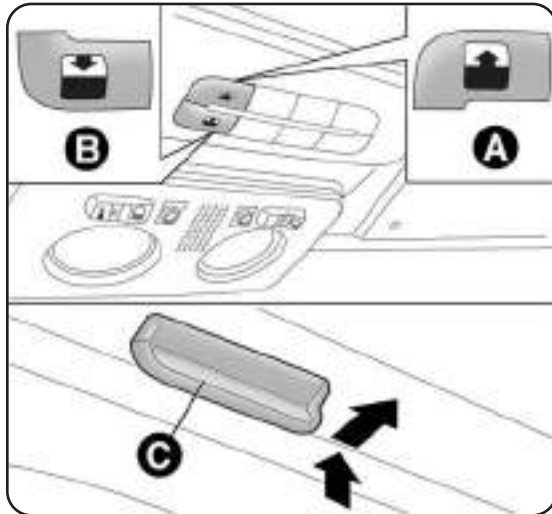

fig. 53

L0E010Sm

IMPORTANT The blind will remain in the fully open position when closing the sun roof. If you would like to close it, this must be done manually.



Use the sunroof only at “spoiler” position if cross roof racks are fitted. Never open the roof in presence of snow or ice to prevent damage.



When leaving the vehicle, always remove the key from the ignition to avoid the risk of injury to those still inside the car due to accidental operation of the sunroof. Improper use of the roof can be dangerous. Before and during operation, always check that nobody is at risk of being injured by the moving sun roof or by objects getting caught or hit by it.

Anti-pinch device

The sun roof has an anti-pinch safety system capable of detecting the presence of an obstacle whilst the roof is closing; if this happens, the system intervenes and the movement of the glass is immediately reversed.

INITIALISATION PROCEDURE

After the battery has been disconnected or a fuse has blown, the operation of the sun roof must be initialised again.

Proceed as follows:

- press button A - fig. 53 until the sun roof is completely closed. Release the button;
- press and hold down button A for at least 10 seconds and/or until the glass panel moves forwards by one click. Release the button at this point;
- press button A within 5 seconds of this operation and keep it pressed: the glass panel will complete a full opening and closing cycle. Release the button only at the end of this cycle.

EMERGENCY MANOEUVRE

If the switch does not work, the sun roof can be operated manually as follows:

- remove protective cap A - fig. 54 on the rear part of the internal cover;
- take the Allen key provided from the container with the on-board documentation or from the luggage compartment (versions with Fix&Go automatic);
- fit the key into seat B and turn it:
 - clockwise to open the sunroof;
 - anticlockwise to close the roof.

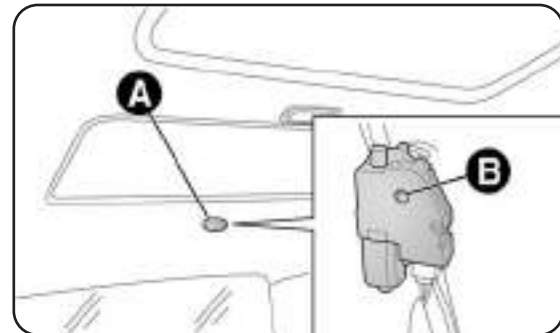



fig. 54



DOORS

LOCK/RELEASE FROM OUTSIDE fig. 55

Door release

To release all doors: turn the key to position 1. Pull up the associated handle to open the door. Press button  on the remote control to unlock the doors.



Before opening a door, ensure that you can do it in conditions of safety. Open the doors only when the car is stationary.

Door lock

To lock all doors: turn the key to position 2 with doors fully closed.

Press button  on the remote control to lock the doors. If one of the doors is not shut properly, simultaneous locking is disabled.

IMPORTANT If one of the doors is not properly closed or if there is a fault in the system, the central locking will not engage. If the operation is repeated 10/11 times in quick succession, the device is excluded for approximately 30 seconds.

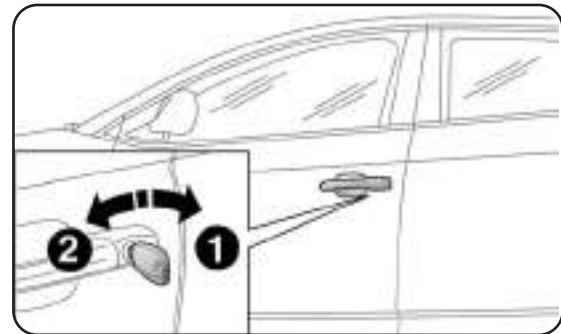

fig. 55

L0E0042m

LOCK/RELEASE FROM INSIDE fig. 56

Press the door lock/release button A, located in the dashboard, from inside the car (with the doors shut). If the electrical system has failed, it is still possible to lock the doors manually.

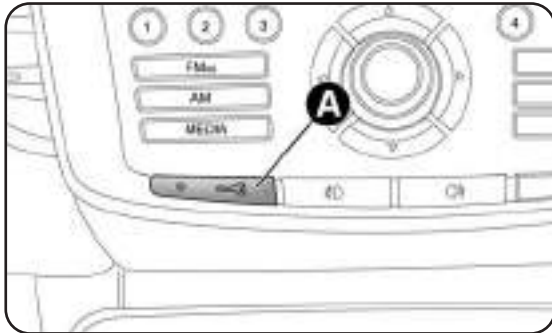

fig. 56

L0E0043m

CHILD LOCK SYSTEM B - fig. 57

This system prevents the rear doors from being opened from the inside.

This device can only be engaged with the doors open:

- position 1 - device engaged (door locked);
- position 2 - disengaged (door can be opened from inside).

The device remains engaged even if the doors are unlocked remotely.

IMPORTANT The rear doors cannot be opened from the inside when the child lock system is engaged.



Always use this device when carrying children.



After engaging the child lock on both rear doors, check for proper engagement by trying to open a rear door with the internal handle.





PASSENGER SIDE FRONT DOOR AND REAR DOOR EMERGENCY LOCKING DEVICE

The passenger side front door and the rear doors have a device to lock them when there is no power.

Proceed as follows:

- engage the metal insert of the starting key in position A - fig. 57 (rear doors) or A - fig. 58 (front passenger side door);
- turn the key counter-clockwise and then remove it from position A - fig. 57 or A - fig. 58.

The door lock knob can be realigned (only when the battery charge has been restored) as follows:

- press button  on the key;
- press door lock/release button  in the dashboard;
- open a front door by inserting the key into the key pawl;
- operate the internal door handle.

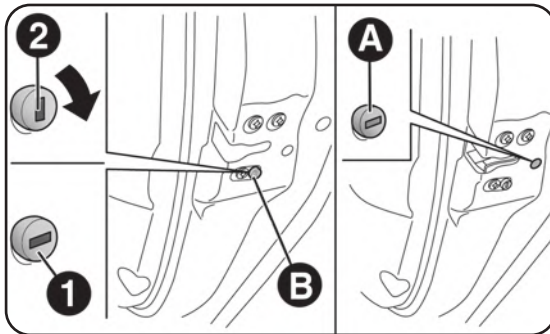

fig. 57

L0E0291m

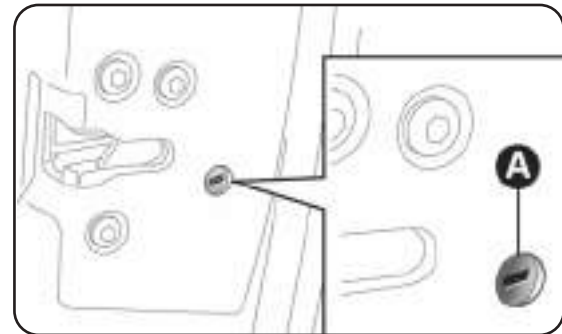







fig. 58

L0E0290m



If the child lock was engaged and the previously described locking procedure carried out, operating the internal handle will not open the door but will only realign the door lock knobs. To open the door, the outside handle must be used. The door central locking/unlocking button is not disabled by the engagement of the emergency lock .

IMPORTANT If the battery is disconnected or the protection fuse blows, the luggage compartment opening/closing mechanism must be initialised as follows:

- shut all the doors;
- press button  on the key or door lock/release button  in the dashboard;
- press button  on the key or door lock/release button  in the dashboard.

ELECTRIC WINDOWS

These operate when the ignition key is turned to MAR and for about 2 minutes after turning the key to STOP or removing it.

The control buttons are located in the door panels (the driver side door panel can be used to operate all the windows).

An anti-pinch device is operated when the front windows are lifted.

CONTROLS fig. 59

- A. opening/closing left hand front window; “continuous automatic” operation during window opening/closing stage;
- B. opening/closing right hand front window; “continuous automatic” operation during window opening/closing stage;
- C. enabling/disabling of rear door electric window controls;
- D. opening/closing left hand rear window (for versions/markets, where provided); “continuous automatic” operation during window opening/closing stage;
- E. opening/closing right hand rear window (for versions/markets, where provided); “continuous automatic” operation during window opening/closing stage;



Window opening

Push the buttons to open/close the desired window. When one of the two buttons is pressed briefly, the window moves in “stages”; if the button is held down, “continuous automatic” operation is activated. If the button is pressed again the window will stop in its current position. Holding the button pressed for a few seconds will automatically raise or lower the window (only with key at MAR).

Window closing

Lift the buttons to close the desired window. The window closing stage occurs following the same logic described for the opening stage.



Improper use of the electric windows can be dangerous. Before and during its operation ensure that any passengers are not at risk from the moving roof either by personal objects getting caught in the mechanism or by being injured by it directly.



Always remove the ignition key when you get out of the car to prevent the sunroof from being operated accidentally and constituting a danger to the people still on board.

Passenger side front door/rear doors

On the passenger side front door control panel, and on some versions also on the rear doors, buttons F - fig. 59 are provided to control the associated windows.

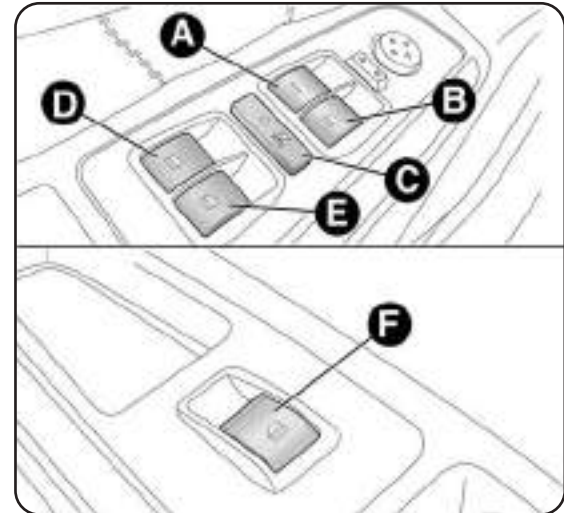

fig. 59

LOE0045m

Anti-crush safety device

The vehicle is equipped with an anti-pinch safety device for the raising of the front windows.

This safety system detects the presence of an obstacle during the window closing travel and cuts in by stopping and reversing the window travel, depending on its position. This device is also useful if the windows are activated accidentally by children on board the vehicle.

The anti-pinch function is active both during manual and automatic operation of the electric windows. Following the intervention of the anti-pinch system, the window travel is immediately interrupted and subsequently reversed until the lower end of travel is reached. The window cannot be operated in any way during this time.

IMPORTANT If the anti-pinch protection intervenes 5 consecutive times within a minute or is faulty, the automatic closing operation of the window is inhibited, only allowing it in steps of half a second; the button is released for the subsequent manoeuvre.

In order to restore the correct operation of the system, one of the following manoeuvres must be performed:

- switch off and restart the engine;
- fully lower the window concerned.

IMPORTANT With ignition key at STOP or removed, the electric windows remain active for about 3 minutes and are deactivated when a door is opened.



Electric window system initialisation

The system must be re-initialised after disconnecting the battery or if the relevant protection fuse is blown.

Initialisation procedure:

- fully close the window to be initialised manually;
- once fully closed, keep holding down the closing control for at least 1 second.

IMPORTANT Where provided, after there has been no power supply for the control units (battery replaced or disconnected or protective fuses for the electric window control units replaced), the automatic operation of the windows must be restored.

The restoration procedure must be performed as described below with the doors closed:

1. completely open the driver's door window keeping the operating button pressed for at least three seconds after the (lower) end of travel position;
2. completely raise the driver's side window and keep the button pressed for at least three seconds once the end of travel position (upper end stop) has been reached;
3. repeat stages 1 and 2 for the passenger-side window
4. make sure that the initialisation is correct by checking that the windows work automatically.

IMPORTANT With central locking on, operating the internal handle of one of the doors will unlock all the doors. If there is no electric power supply (fuse blown, battery disconnected, etc.) it is still possible to operate the door locking manually; in this case the automatic lowering function for the windows is not available and to open or close the door with the window closed it is necessary to exert pressure on the window towards the inside of the vehicle to facilitate the movement of the window on the moulding.

LUGGAGE COMPARTMENT

OPENING

When unlocked, the luggage compartment can be opened from the outside using the handle fig. 60.

The tailgate can be opened at any time, if the doors are unlocked.

The key with remote control should be used to open the tailgate.

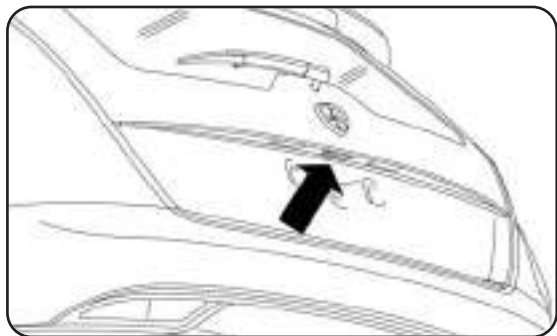

fig. 60

LOE0046m

If the luggage compartment is not closed correctly, this is indicated by a warning light coming on in the instrument panel or a car icon appearing in the display together with a dedicated message (see “Instrument panel warning lights” paragraph in this chapter).

Opening the tailgate will switch the boot light on: the light will go off automatically when closing the tailgate.

The light will stay on for about 15 minutes after turning the key to STOP: if during this time, a door or the tailgate is opened, the light will switch on again for 15 minutes.

Opening the tailgate using the key with remote control

To release the tailgate lock press a car icon. Tailgate opening is indicated by the double flashing of the direction indicators; tailgate closing is indicated by single flashing (only with the alarm switched on, where provided).

**CLOSING fig. 61**

To close, lower the tailgate by pressing near the lock until you hear it click. There are handles B provided inside the tailgate to allow it to be closed more easily.

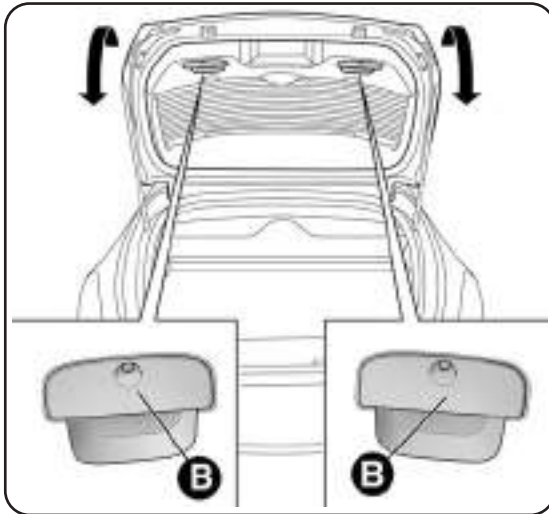

fig. 61

L0E0047m



Never exceed the maximum allowed load in the luggage compartment; see chapter 6. Also make sure that the objects you place in the luggage compartment have been properly secured, to avoid them from being thrown forward consequent to sudden braking and injuring your passengers. Never travel with the tailgate open: exhaust gases may get into the passenger's compartment.



If you travel in areas with few filling stations and you want to transport fuel in a spare tank, comply with the regulations in force and use only an approved, suitably secured tank. Anyway, by doing so, you increase the risk of fire in case of an accident with your vehicle.



Be careful not to hit objects on the storage shelf when you open the tailgate.

OPENING THE TAILGATE IN AN EMERGENCY**fig. 62**

To open the tailgate from the passenger compartment if the car battery is flat or the electric tailgate lock is faulty, proceed as follows (see “Extending the boot” in this chapter)

- remove the rear head restraints;
- fold over the backrests;
- operate lever A to unlock the tailgate mechanically from inside the luggage compartment.

EXTENDING THE LUGGAGE COMPARTMENT

IMPORTANT If the rear seat backrest is folded down, releasing the rear curtains of the parcel shelf is strictly compulsory (follow the specific indications in the “Parcel shelf” paragraph).

The luggage compartment can be partially (1/3 or 2/3) or totally extended by splitting the rear seat fig. 63.

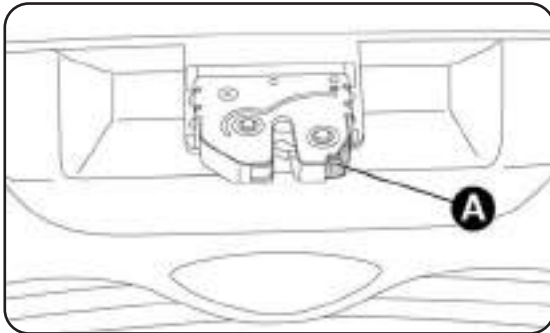

fig. 62

LOE004Sm

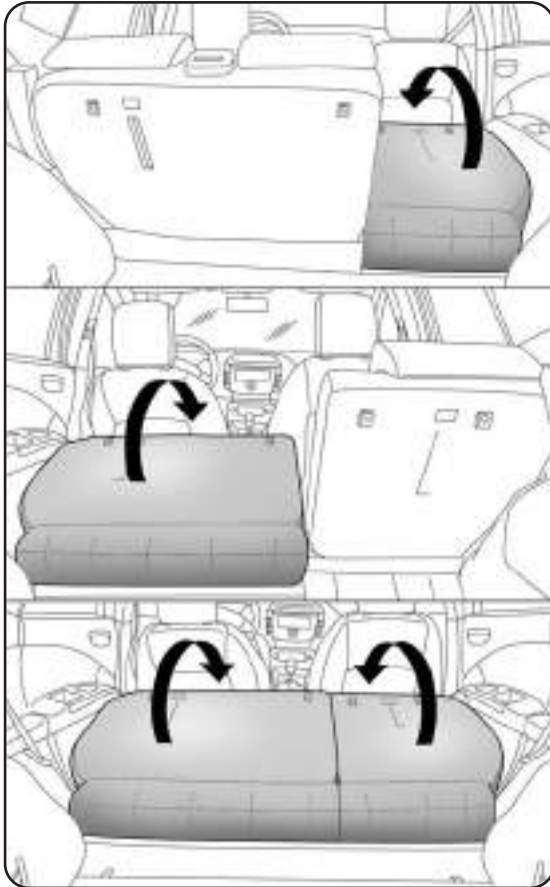

fig. 63

L0E0110m

Proceed as follows to extend the luggage compartment:

- completely lower the rear seat head restraints;
- move the seat belt to the side, making sure that it is fully extended and not twisted;
- release the parcel shelf curtains (for versions/markets, where provided) from the backrests (see paragraph “Parcel shelf” on the next pages);
- adjust one of levers A - fig. 64 to fold the desired backrest (to facilitate this operation, slightly move the seat forwards by operating lever B, for versions/markets where provided).

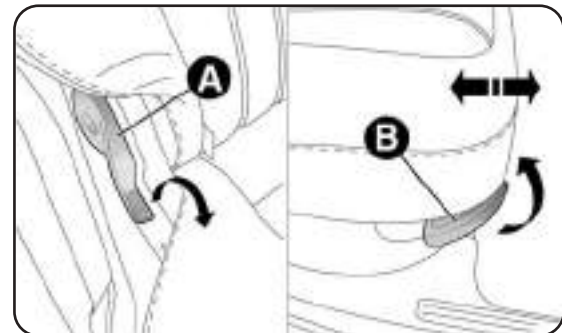

fig. 64

L0E0049m

To extend the luggage compartment further, the rear seats can be pushed forwards by operating handle B - fig. 64 (for versions/markets where provided).

IMPORTANT In order to achieve a uniformly flat load platform, the head restraints should be placed in the fully extended position before the seats are folded back.

REPOSITIONING THE REAR SEAT

To facilitate the backrest repositioning manoeuvre, it is helpful to bring the seat cushion completely forward before folding back the seats.

Move the seat belts to the side, making sure that they are correctly extended and not twisted.

Press levers A - fig. 64, lift up the backrests and push them backwards until you hear a click from both attachment mechanisms. Use handle B - fig. 64 (for versions/markets where provided) to move the seats back until you hear a click.



Make sure the backrest is properly secured at both sides to prevent it from moving forward in the event of sharp braking, which may cause injuries to passengers.



PARCEL SHELF

To take out the parcel shelf, proceed as follows:

- release the curtains of the parcel shelf A - fig. 65 from the attachments B on the rear seat backrests;

- grasp the tabs C and guide the curtains in the retractor;
- release attachments A - fig. 66 (one on each side);
- release attachments B, rotate the parcel shelf through 90° and slide it out.

To refit the parcel shelf, reverse the removal instructions.

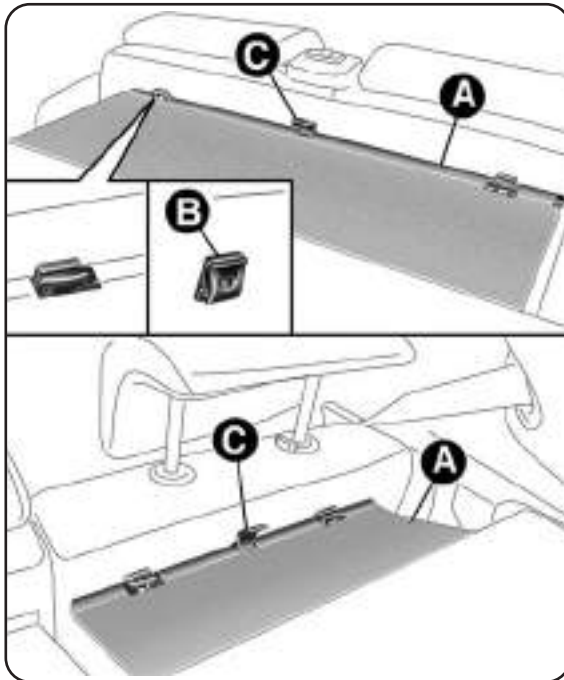

fig. 65

L0E02S4m

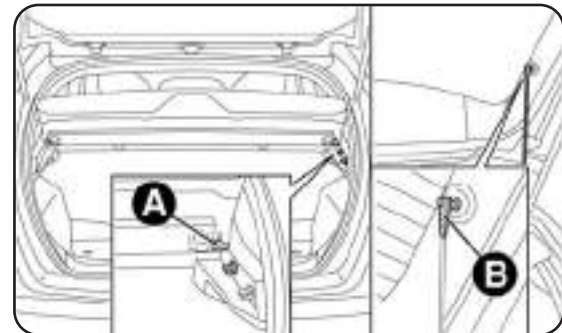

fig. 66

L0E0051m

BONNET

OPENING fig. 67

Proceed as follows:

- pull lever A in the direction indicated by the arrow;
- operate lever B as shown in the figure;
- lift the bonnet and, at the same time, release stay rod C from its catch, then insert the end of the rod into housing D in the bonnet (larger hole) and push to safety position (smaller hole), as shown in the diagram.



Incorrect positioning of the stay rod may cause the bonnet to drop suddenly. Perform these operations when the car is stationary only.



Before lifting the bonnet, ensure that the wiper arm is not lifted from the windscreen.

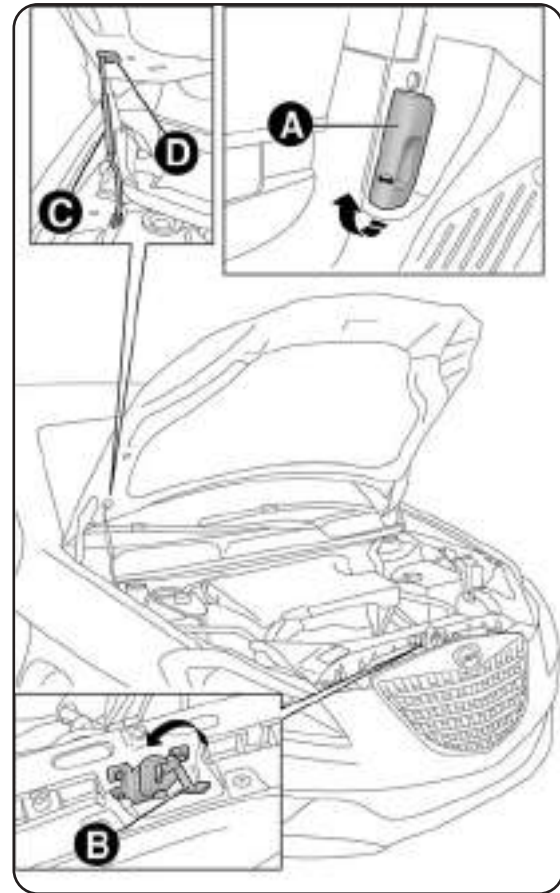

fig. 67



With hot engine, operate with caution inside the engine compartment to avoid burns. Do not place your hands near the engine fan as it may be activated even when the switch is disabled. Wait for engine cooling.



Pay attention to scarves, ties and other loose fitting garments. If they accidentally touch moving parts, they may get dragged with serious risks for those who wear them.

CLOSING fig. 67

Proceed as follows:

- Hold the bonnet up with one hand and with the other remove rod C from housing D and put it back into its catch;
- Lower the bonnet to approximately 20 centimetres from the engine compartment and let it drop. Make sure that the bonnet is completely closed and not only fastened by the safety catch by trying to open it. If it is not fully closed, open the bonnet and repeat the procedure. Do not simply press it.



For safety reasons, the bonnet must always be properly closed while driving. Make sure that the bonnet is perfectly closed and that the lock is engaged. If you discover that the bonnet is not perfectly closed during travel, stop immediately and close the bonnet in the correct manner.

ROOF RACK/SKI RACK

FASTENERS

The attachments are located in the areas illustrated in fig. 68 and can only be reached with the doors open.

Lineaccessori provides a specific roof rack/ski rack for the tailgate.

IMPORTANT Follow the instructions contained in the assembly kit carefully. Assembly must be performed by qualified personnel.



After having travelled several kilometres check that the attachment fixing screws are properly fastened.



Always comply with local legislation regarding maximum load size.



Distribute the load uniformly and when driving take into consideration the increased sensitivity to cross winds.



Never exceed the maximum permitted loads; see chapter "6".

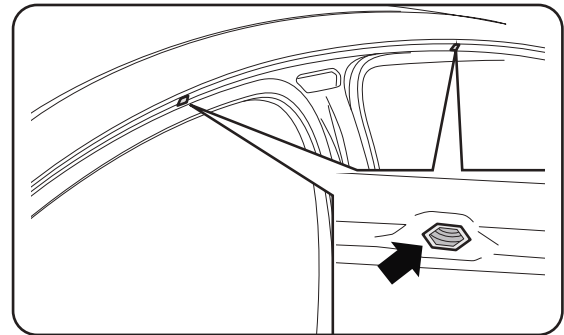

fig. 68



HEADLIGHTS

LIGHT BEAM ALIGNMENT

The correct aiming of the headlights is important for the comfort and safety of not only the driver but all other road users. This is also covered by a specific rule of the highway code.

The headlights must be correctly aimed to guarantee the best visibility conditions for all drivers while travelling with headlights on.

Contact a Lancia Dealership to have the headlights properly adjusted.

Check beam alignment every time the load or its distribution changes.

ANGLE COMPENSATION **fig.69**

The car is fitted with an electric headlight alignment system. This system is operational with the ignition key turned to MAR and the dipped beam headlights on.

When the car is loaded, it slopes backwards. This means the headlight beam rises.

In this case, it is necessary to adjust the beams using buttons A and B.

The display provides a visual indication of the positions during adjustment.

Correct positions depending on the load

Position 0 - one or two people in the front seats.

Position 1 - five passengers.

Position 2 - five people + load in the boot.

Position 3 - driver + maximum permitted load stowed in the luggage compartment.

FRONT FOG LIGHTS ALIGNMENT

(for versions/markets where provided)

Contact a Lancia Dealership to have the headlights properly adjusted.

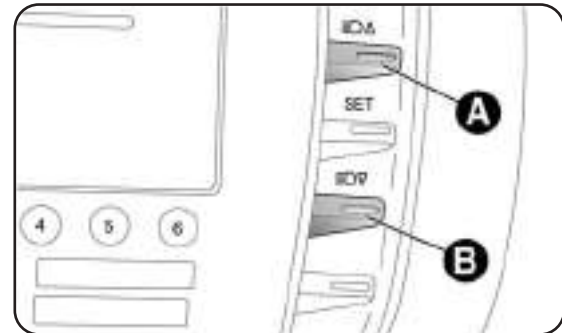

fig. 69

L0E0054m

ADJUSTING THE HEADLIGHTS ABROAD

Dipped headlights are adjusted to drive in the country where the vehicle was originally purchased. When travelling in countries with opposite driving direction, to avoid dazzling the drivers on the other side of the road, you need to cover areas of the headlight according to the Highway code of the country you are travelling in.



ADAPTIVE LIGHTS (AFS - Adaptive Xenon Light)

This is a system combined with Xenon headlights which directs the main light beam and continuously and automatically adapts it to the driving conditions round bends/when cornering. The system directs the light beam to light up the road in the best way, taking into account the speed of the vehicle, the bend/corner angle and the speed of steering.

Activating/deactivating the system fig. 70

The adaptive lights are automatically activated when the car is started. In this situation the LED (amber) on button A will remain off.

Press button A to deactivate the adaptive lights (if activated); they will be deactivated and the LED on button A will come on constantly. Press AFS button again to turn the adaptive lights on (LED off on the button).

In the event of a system failure, an indication is provided on the instrument panel by the flashing of  warning light or the  symbol appearing on the display along with a dedicated message (for versions/markets where provided).

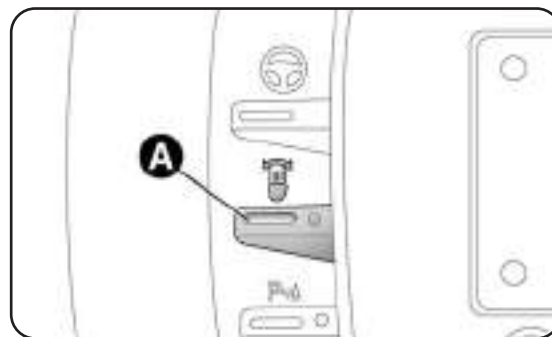

fig. 70



DST SYSTEM (Dynamic Steering Torque)

This system is incorporated with the ESP control unit and suggests steering corrections whilst driving via the electric power steering. The system applies a torque to the steering wheel which increases the safety perception of the vehicle, maintaining control of the steering and making the intervention of the Advanced ESP system less intrusive.

SPORT FUNCTION

(for versions/markets, where provided)

The vehicle may be equipped with a system that allows a choice between two styles of driving, normal and sports. Pressing the SPORT button fig. 71 produces sporty driving featuring higher acceleration response and more effort required on the steering wheel to produce this effect. When the function is active, "S" is lit up in the instrument panel. Press the button again to turn the function off and restore the normal driving setting.



fig. 71

L0E0055m

IMPORTANT The function is activated about 5 seconds after the SPORT button is pressed.

IMPORTANT The steering may become stiffer during parking manoeuvres including a great deal of steering. This is normal and caused by the system preventing the electric control motor overheating. No repairs are needed. The power steering system will start working normally again the next time the car is used.



On some versions, with the CITY function activated, the SPORT function is not available. To activate the SPORT function, deactivate the CITY function and vice versa, because they are reciprocally incompatible.



Under no circumstances should aftermarket operations be carried out involving steering system or steering column modifications (e.g. installation of anti-theft device). This could negatively affect performance and safety; invalidate the warranty; cause serious safety problems and also result in vehicle non-compliance with type-approval requirements.



Before servicing the car, switch off the engine and remove the key from the ignition device to activate the steering lock. This is especially important when the car wheels are not touching the ground. If this is not possible (i.e. if the key must be kept in the MAR position or the engine must be kept running), remove the main electric power steering system fuse.



REACTIVE SUSPENSION SYSTEM (Active shock absorber system)

This system interacts with the Sport function (see “Sport function” paragraph).

The SPORT button, fig. 72, allows you to choose between two different driving settings depending on the route type and on the road surface:

- with the button released: “normal” mode
- with the button pressed: “SPORT” mode.



fig. 72

L0E005Sm

In “normal” operating mode, active shock absorbers adjust car suspensions, adapting them to the type of road and to the driving stresses, improving driving comfort in particular on rough terrain.

In “SPORT” operating mode, the letter “S” is lit up on the instrument panel display. This function produces a sports driving setting featuring greater responsiveness during acceleration and a sports driving feeling with the steering, as well as the regulation and distribution of the damping at the shock absorbers guaranteeing greater vehicle precision and reaction, whilst maintaining a good level of comfort. The driver will notice that the vehicle is more precise when cornering and quicker in changing direction.

This function is particularly useful whenever maximum performance is required for a short time (e.g. when overtaking).

IMPORTANT During acceleration, when the SPORT function is used, the steering may shudder, which is typical of a sports setting.

IMPORTANT The function is activated about 5 seconds after the SPORT button is pressed.

System failure

In the event of a malfunction, the system notifies the driver of the fault via a dedicated message in the reconfigurable multifunction display instrument panel and the amber  symbol coming on.

In this case, go to a Lancia Dealership.

DRIVING ADVISOR

(Lane crossing warning)

(for versions/markets, where provided)



The Driving Advisor is a warning system which notifies the driver if they cross lanes, assisting the driver when distracted.

A video sensor, fitted on the windscreen near the interior rear view mirror, detects the lane demarcation lines and the position of the car in relation to them.

IMPORTANT On cars with Driving Advisor, it is advisable to contact a Lancia Dealership should the windscreen need to be replaced. If the repair is being carried out at a specialist window replacement centre, it is still necessary to go to a Lancia Dealership to have the TV camera calibrated.



OPERATION

The system is not on when the vehicle is started. It is only activated when the button  in the dashboard is pressed. The LED on the button switches on to confirm that the system has been activated and a dedicated message appears on the display. When activated, the system starts recognising operating conditions (condition signalled to the driver by the LED on the button and the  symbol on the instrument panel flashing). Once the system has recognised the operating conditions, it becomes active. Therefore: the  icon in the instrument panel switches off and the LED on the button remains on constantly.

IMPORTANT If the operating conditions are no longer present then the system will deactivate. This is signalled to the driver by the LED on the button flashing and the amber  icon on the instrument panel flashing.

OPERATING CONDITIONS FOR ACTIVATION

Once switched on, the system becomes active only if the following conditions are met:

- always keep at least one hand on the steering wheel;
- vehicle speed between 65 km/h and 180 km/h;
- presence of lane demarcation lines not deteriorated and visible on both sides;
- suitable visibility conditions;
- straight line or wide radius bends;
- visual field condition sufficient (safe distance from vehicle in front).

SYSTEM ACTIVATION/DEACTIVATION

With the system on, if the vehicle approaches one of the lines defining the side of the lane, a torque is applied to the steering wheel to let the driver know which direction to steer in order to stay within the lane. If the driver turns on the direction indicator in order to change lanes or for overtaking, then the system will switch off momentarily. If the driver wishes to change lanes without turning the direction indicator on, then there will be a warning from the steering wheel that they are about to cross the line.

If the driver continues with the manoeuvre to change lanes, the system will be temporarily deactivated and then switch back on again once it has recognized the new driving lane. The driver is advised of this temporary deactivation by the flashing of the LED on the button and the flashing of the  amber symbol on the display.

IMPORTANT The force applied to the steering wheel by the system is sufficient for the driver to notice it but they can easily override it and maintain control of the vehicle.

DEACTIVATING THE SYSTEM

Manual mode

The system can be deactivated by pressing button A - fig. 73 in the dashboard.

Confirmation that the system has been switched off is given by the LED in the button and the message 1 - fig.74 in the display going out.



Automatic mode

The system can be deactivated automatically (if the system is required it will therefore need to be reactivated). The driver is advised that the system has been turned off automatically by three consecutive acoustic signals and the message 1 – fig. 74 in the display in the following conditions:

- the driver does not keep their hands on the steering wheel (indication 2 - fig. 74 is shown on the instrument panel and an acoustic signal sounds until the driver places his hands back on the wheel. This is considered a dangerous condition and the system is automatically deactivated);
- intervention of the vehicle safety systems (ABS, ESP, ASR, DST and TTC);
- the driver activates the sports driving setting pressing the SPORT button (for versions/markets where provided).

IMPORTANT The system cannot be activated if the driver has previously selected the sports driving mode. The impossibility of using the system will be communicated to the driver by three consecutive beeps and by the message 1 - fig. 74 in the display.

SYSTEM FAILURE

In the event of malfunction, the system advises the driver of the fault through message 3 - fig. 74 on the display and an acoustic signal.

IMPORTANT

The driving advisor does not work due to a malfunction of the following safety systems: ABS, ESP, ASR, DST and TTC.



The driving advisor is not an automatic driving system and does not replace the driver in controlling the trajectory of the car. The driver is personally responsible for maintaining a suitable level of attention to the traffic and road conditions and for controlling the trajectory of the vehicle safely.

The operation of the driving advisor can be adversely affected by poor visibility conditions (fog, rain, snow), extreme light conditions (glare of the sun, darkness), lack of cleanliness or damage, even partial, to the windscreen in the area behind the TV camera.

The area of the windscreen by the TV camera must not be partly or totally obscured by objects (e.g. stickers, protective film, etc.).



When the lane demarcation lines are not sufficiently visible, covered or non-existent, the driving advisor cannot help the driver and the system will not be activated.

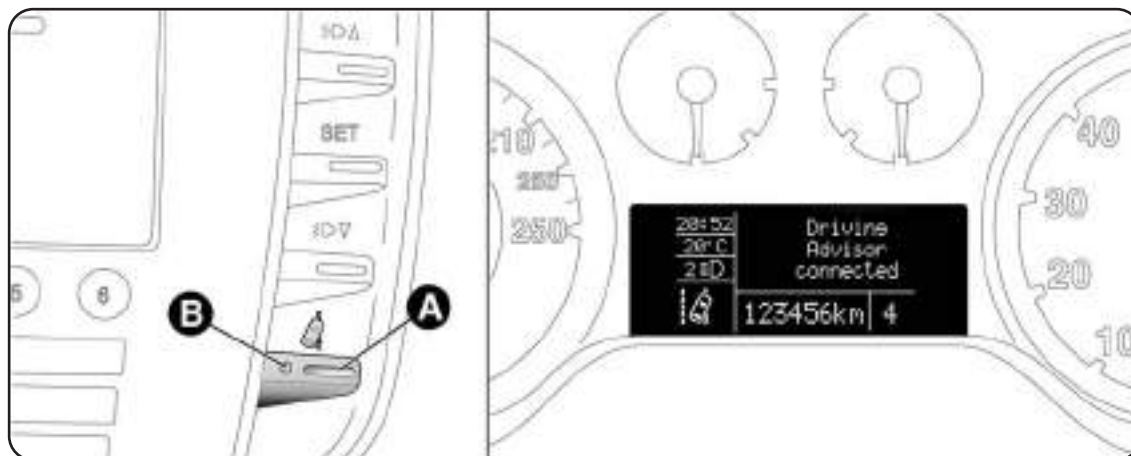

fig. 73

LOE1009g

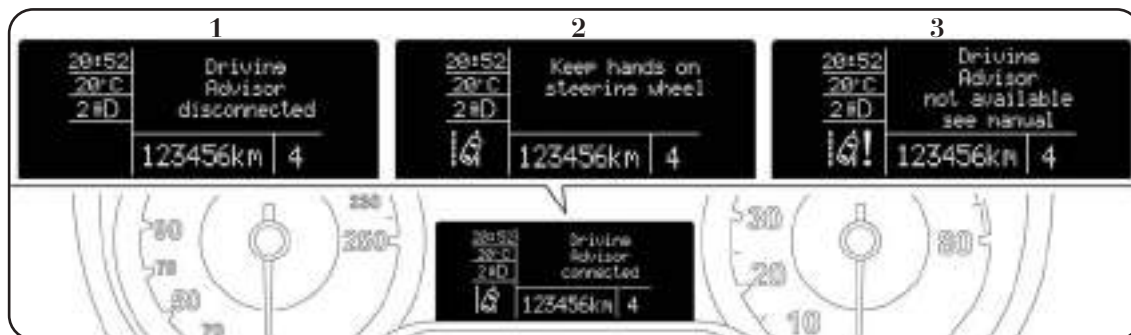





fig. 74

LOE1010g

TABLE SUMMARISING SIGNALS DURING THE USE OF THE DRIVING ADVISOR

LED status	Message on the on the button	Icon status display (fig. 73 and 74)	Signal on display	Meaning sound
Off	–	–	–	System not active
On flashing	Driving Advisor active	 On flashing	–	The system has been switched on and is not active
On flashing	–	 On flashing	–	The system searches for the operating conditions
On constantly	–	–	–	The system is active and the operating conditions were acknowledged
On constantly	Driving Advisor active	–	–	The system has been switched on and is immediately active
Off	Driving Advisor off	–	–	The system has been turned off manually
Off	Driving Advisor off	–	3 warnings	The system has been turned off automatically
On constantly	Keep your hands on the steering wheel	 Constantly on	Single repeated warning	The system warns the driver to place their hands on the steering wheel
Off	Driving Advisor not available see handbook	 Constantly on	Single warning	The system is faulty: go to a Lancia Dealership
Off	Driving Advisor off	–	3 warnings	The system has not been activated due to the activation of sports driving mode



ADVANCED ESP SYSTEM (ELECTRONIC STABILITY PROGRAM)

This is an electronic system controlling car stability in the event of tyre grip loss, helping to maintain directional control.

The Advanced ESP system is therefore particularly useful when road surface grip conditions change.

With the Advanced ESP system as well as the ASR (traction control with intervention on the brakes and the engine) plus the HILL HOLDER (device for hill starts without using the brakes) and also MSR (adjustment of engine braking force with gear downshift), HBA (automatic increase in braking pressure during emergency braking), ABS (preventing the wheels from locking and slipping on all road surfaces during sharp braking and DST (application of force on the steering wheel for steering correction) functions are all available.

SYSTEM INTERVENTION

This is signalled by the blinking of the  warning light on the instrument panel, to inform the driver that the car is in critical stability and grip conditions.

Switching the system on

The Advanced ESP system comes on automatically when the vehicle is started and cannot be turned off.

Fault indications

In the event of a failure, the Advanced ESP system will be automatically switched off and  warning light will appear constantly in the instrument panel along with a message on the reconfigurable multifunction display. The LED on the ASR OFF button will also light up (see “Instrument panel warning lights” chapter). In this case, go to a Lancia Dealership.



The performance of the Advanced ESP system should not encourage the driver to take unnecessary risks. Driving style must always be adapted to road conditions, visibility and traffic. The driver is ultimately responsible for road safety.

HILL HOLDER SYSTEM

This is an integral part of the Advanced ESP system and automatically cuts in in the following conditions:

- uphill: car at a standstill on a road with a gradient higher than 5%, engine running, clutch and brake pedal pressed, gearbox in neutral or engaged gear other than reverse.
- downhill: car at a standstill on a road with a gradient higher than 5%, engine running, clutch and brake pedal pressed and reverse gear engaged.

During take off the Advanced ESP system control unit maintains the braking pressure at the wheels until the engine torque required for departure is reached or for a maximum of 2 seconds, allowing your right foot to be moved easily from the brake pedal to the accelerator.

When two seconds have elapsed, without starting, the system is automatically deactivated, gradually releasing the braking pressure. During this release stage it is possible to hear a typical mechanical brake release noise, indicating the imminent move of the car.

Fault indications

System failure is indicated by the  warning light lighting up in the instrument panel together with a dedicated message appearing in the reconfigurable multifunction display; see “Instrument panel warning lights” chapter.

IMPORTANT The Hill Holder system is not a parking brake; therefore, never leave the vehicle without having engaged the handbrake, turned the engine off engaged the first gear.



The Advanced ESP system continues to operate if the space-saver wheel is fitted. Always remember that the space-saver wheel, being smaller than the original wheel provides less grip.

For the correct operation of the Advanced ESP and ASR systems, the tyres must absolutely be the same make and type on all wheels, in perfect conditions and, above all, of the type, make and size specified.



ASR SYSTEM (Antislip Regulation)

This is integral to the ESP system and automatically intervenes if one or both drive wheels slip, helping the driver to control the car. The action of the ASR system is particularly helpful in the following circumstances:

- slipping of the inner wheel when cornering due to the effect of dynamic load changes or excessive acceleration;
- too much power transmitted to the wheels. also in relation to road surface conditions;
- acceleration on slippery, snowy or frozen road surfaces;
- in the event of loss of grip on a wet surface (aquaplaning).

MSR SYSTEM (engine drive regulation)

The MSR system is an integral part of the ASR, that intervenes, if there is a sudden change to a lower gear, restoring torque to the engine, thereby preventing excessive drive at the drive wheels which, especially in poor grip conditions, could lead to a loss in stability of the vehicle.

Switching ASR system on/off fig. 75

The ASR system switches on automatically each time the engine is started. Whilst driving, the ASR can be switched off and subsequently switched on again by pressing the ASR OFF button.

When the system is active, a message on the reconfigurable multifunction display is displayed.

When the system is deactivated, the LED on the ASR OFF button turns on and a message appears in the reconfigurable multifunction display. When the ASR is switched off whilst driving, the next time the car is started up the ASR is automatically switched on by the system.

When travelling on snowy roads with snow chains, it may be helpful to turn the ASR off: in fact, in these conditions, the driving wheels skidding when moving off gives you better traction.

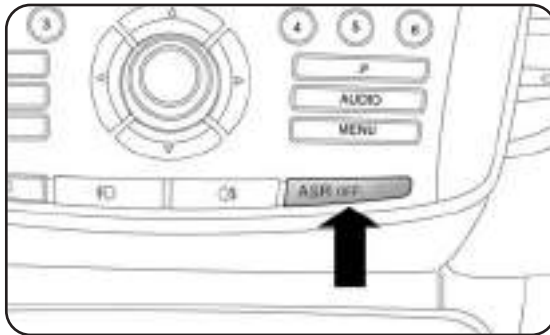

fig. 75

LOE0056m

**TTC SYSTEM (Electronic self-locking differential)**

THIS IS a system, which is an integral part of the ASR, that intervenes on entering bends giving drive torque to the outer wheel and braking the inner wheel.

In this way the effect of a self-locking differential is simulated, increasing the sportiness of the car and improving cornering.

ABS

This system, which is an integral part of the braking system, prevents one or more wheels from locking and slipping in all road surface conditions, irrespective of the intensity of the braking action, ensuring that the vehicle can be controlled even during emergency braking.

The EBD system (Electronic Braking Force Distribution) completes the system allowing the brake force to be distributed between the front and rear wheels.

IMPORTANT To get the maximum efficiency of the braking system, a bedding-in period of about 500 km is needed: during this period it is better to avoid sharp, repeated and prolonged braking.

System intervention

The driver can feel that the ABS has come into action because the brake pedal pulsates slightly and the system gets noisier: this means that the car speed should be changed to suit the type of road surface.



When the ABS cuts in and you feel the brake pedal pulsating, do not raise your foot, but keep it pressed; in doing so you will stop in the shortest amount of space possible depending on the current road conditions.



If the ABS cuts in, it means that the grip between the tyre and the road surface is close to its limit; you must slow down to match the speed to the road grip available.



The ABS make the best use of the available grip but cannot increase it. You should always drive carefully on slippery surfaces and avoid any unnecessary risks.





FAULT INDICATIONS

ABS failure

This is signalled by the  warning light in the instrument panel coming on together with a message in the reconfigurable multifunction display. In this case, the braking system will still be effective, although without the extra capacity offered by the ABS. Drive carefully to the nearest Lancia Dealership to have the system checked.

EBD failure

This is signalled by the  and  warning lights on the instrument panel coming on, together with a message on the reconfigurable multifunction display. In this case, the rear wheels may suddenly lock and the vehicle may swerve when braking sharply.

Therefore, drive very cautiously to the nearest Lancia Dealership to have the system checked.



If only  warning light on the instrument panel comes on, with a message in the reconfigurable multifunction display; stop the car immediately and contact the nearest Lancia Dealership. Leakage of hydraulic fluid from the braking system will compromise the operation of the braking system, whether it is of the conventional type or with ABS.

EOBD SYSTEM

The EOBD system (European On Board Diagnosis) carries out a continuous diagnosis of the components of the car related to emissions. It also alerts the driver, by turning on the  warning light in the instrument panel together with a message in the reconfigurable multifunction display, when these components are no longer in peak condition (see “Instrument panel warning lights” paragraph).

The goal of the system is to:

- to keep system efficiency under control;
- to signal a fault which causes emission levels to increase;
- to signal the need to replace deteriorated components.

The system also has a connector that can be interfaced with appropriate equipment, which makes it possible to read the error codes stored in the control unit together with a series of specific parameters for engine operation and diagnosis.

This check can also be carried out by traffic control authorities.

IMPORTANT After eliminating the failure, to check the system completely, Lancia Dealerships run a bench test and, if necessary, road tests which may also call for a long journey.



“DUALDRIVE” ELECTRIC POWER STEERING SYSTEM

This is an electrically controlled power steering system called “Dualdrive”. It is only operational with the ignition key turned to MAR and the engine running; it can be customised by the driver according to the driving conditions.

IMPORTANT When turning the ignition key quickly, complete power steering functionality may be achieved after 1-2 seconds.

CITY FUNCTION ACTIVATION/DEACTIVATION

Press button A - fig.76 to activate/deactivate the function. When the function is active, the CITY warning light on the instrument panel turns on.

When the CITY function is on, the steering wheel effort is lighter and parking operations are easier: therefore this function is particularly useful for driving in city centres.

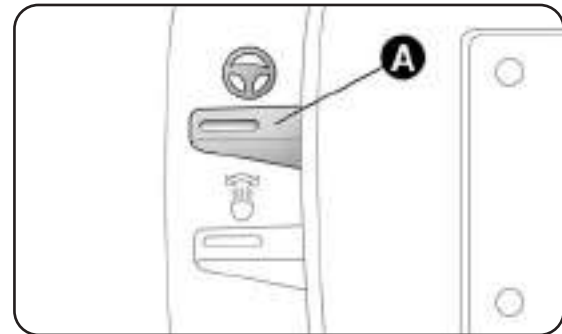

fig. 76

L0E0057m





On some versions, with the CITY function activated, the SPORT function is not available. To activate the SPORT function, deactivate the CITY function and vice versa, because they are reciprocally incompatible.



Under no circumstances should aftermarket operations be carried out involving steering system or steering column modifications (e.g. installation of anti-theft device). This could negatively affect performance and safety; invalidate the warranty; cause serious safety problems and also result in vehicle non-compliance with type-approval requirements.

FAULT INDICATIONS

Any failure of the electric power steering is indicated by instrument panel  warning light coming on together with a message in the reconfigurable multifunction display. In the event of electric power steering system failure, the car can be driven with mechanical steering.

IMPORTANT In some circumstances, factors independent of the electric power steering could cause the  warning light on the instrument panel to come on. In this case, stop the car immediately, switch off the engine for about 20 seconds and then restart the engine. If the  warning light remains on, together with the message on the reconfigurable multifunction display, contact a Lancia Dealership as soon as possible.



IMPORTANT The steering may become slightly stiff following parking manoeuvres involving a lot of steering. This is normal and is caused by a system to prevent the motor from overheating. No servicing is required. The power steering system will start working normally again the next time the car is used.



Before starting any servicing operation, stop the engine and remove the key from the ignition switch to operate the steering lock, particularly when the wheels do not touch the ground. If this is not possible (i.e. if the key must be kept in the MAR position or the engine must be kept running), remove the main electric power steering system fuse.

TPMS SYSTEM **(Tyre Pressure Monitoring System)**

(for versions/markets, where provided)

The car may be equipped with a TPMS (Tyre Pressure Monitoring System). This system comprises a radio frequency transmitter fitted to each wheel (on the wheel rim inside the tyre), which is able to send information on the tyre inflation pressure of each wheel to the control unit.

IMPORTANT NOTES ABOUT THE TPMS

The fault indications are not stored and will therefore not be displayed after the engine has been switched off and then on again. If the fault conditions persist, the control unit will send the relative indications to the instrument panel only after the car has been in motion for a short time.



The tyre repair kit (Fix&Go Automatic) provided with the car is compatible with the TPMS sensors; using sealants not equivalent with that in the original kit may adversely affect its operation. If sealants not equivalent with the original one are used, it is recommended to have the TPMS sensors checked by a qualified repair centre.



The TPMS cannot indicate sudden tyre pressure drops (for example when a tyre blows out). In this case stop the car, braking with care and avoiding sharp steering actions.



Replacing the normal tyres with winter tyres and vice versa requires the inspection of the TPMS, which should only be carried out by a Lancia Dealership.



The TPMS requires the use of specific equipment. Contact a Lancia Dealership to find out which accessories are compatible with the system (wheels, hub caps etc.). The use of other accessories may affect the normal operation of the system.



Tyre inflation pressure may vary according to outdoor temperature. The TPMS may temporarily indicate insufficient pressure. In this case, check the tyre pressures with the tyres cold and, if necessary, restore the inflation values.



If the vehicle is equipped with the TPMS, when a tyre is removed, it is advisable to replace the rubber gasket for the valve. Contact a Lancia Dealership.



If the vehicle is equipped with the TPMS, tyre and/or rim fitting/removal operations require specific precautions. To avoid damaging the sensors or fitting them incorrectly, tyre and/or rims fitting/removal operations should be carried out only by specialists. Contact a Lancia Dealership.



Particularly strong radiofrequency interference may cause the TPMS to operate incorrectly. This condition is indicated to the driver by the  warning light or symbol lighting up on the display together with a dedicated message. The message will disappear automatically as soon as the interference ceases to disturb the system.

In order to use the system properly, refer to the following table when you have to change wheels/tyres:

Operation	Sensor	Signal fault	Service Operation Lancia Dealership
–	–	YES	Contact a Lancia Dealership.
Replacing a wheel with the spare wheel	NO	YES	Repair the damaged wheel
Replacing the wheels with winter tyres	NO	YES	Contact a Lancia Dealership.
Replacing the wheels with winter tyres	YES	NO	–
Replacing the wheels with others of a different size (*)	YES	NO	Contact a Lancia Dealership.
Swapping wheels (front/rear) (**)	YES	NO	–

(*) Given as an alternative in the Owner Handbook and available at Lineaccessori Lancia.

(**) Not cross-swapped (tyres must stay on the same side).



PARKING SENSORS

(for versions/markets where provided)

The parking sensors are located in the rear bumper fig. 77 and their function is to inform the driver, through an intermittent acoustic signal, of the presence of obstacles behind the car.

ACTIVATION/DEACTIVATION

The sensors are automatically activated when reverse gear is engaged. As the obstacle behind the car gets closer, the acoustic signal becomes more frequent.

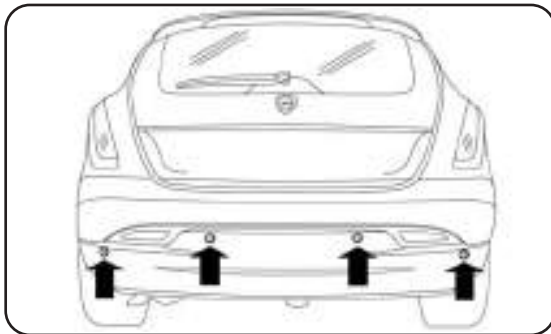

fig. 77

L0E0059m

ACOUSTIC SIGNAL

When reverse gear is engaged and there is an obstacle behind the car an acoustic signal is activated and the signal varies as the distance of the obstacle from the bumper varies.

The frequency of the acoustic signal:

- increases as the distance between the car and the obstacle decreases;
- becomes continuous when the distance between the car and the obstacle is less than around 30 cm and stops immediately if the distance increases;
- is constant if the distance is unchanged.

Detection distances

Centre operating radius 140 cm

Side operating radius 60 cm

If several obstacles are detected by the sensors, only the nearest one is considered.

FAILURE INDICATIONS

Any faults in the parking sensor system are indicated, when reverse gear is engaged, by the  warning light on the instrument panel lighting up and a dedicated message appearing in the multifunction display.

OPERATION WITH TRAILER

Sensor operation is automatically deactivated when the trailer's electric cable plug is fitted in the car's tow hook socket.

The sensors are automatically reactivated when the trailer's cable plug is removed.



For correct operation, sensors must always be clean from mud, dirt, snow or ice. Be careful not to scratch or damage the sensors while cleaning them. Avoid using dry, rough or hard cloths. The sensors must be washed using clean water, with the addition of car shampoo if necessary. When using special washing equipment such as high pressure jets or steam cleaning, clean the sensors very quickly keeping the jet more than 10 cm away.

IMPORTANT INFORMATION

- When parking, watch out for obstacles that may be above or under the sensors.
- Sometimes, objects placed close to the car are not detected and could therefore cause damage to the car or be damaged themselves.



The following conditions may influence the performance of the parking assistance system:

- Reduced sensor sensitivity and a reduction in the parking assistance system performance could be due to the presence on the surface of the sensor of: ice, snow, mud, thick paint.
- The sensor may detect a non-existent obstacle (echo interference) due to mechanical interferences, for example when washing the vehicle, rain (strong wind), hail.
- The indications sent by the sensor can also be altered by the presence of ultrasound devices (e.g. pneumatic brake systems or pneumatic drills) near the car.
- The performance of the parking assistance system could be affected by the position of the sensors, e.g. by altering attitude (due to wear of shock absorbers and suspension) or by changing tyres, overloading the car or setting special attitudes that require the car to be lowered.



Parking manoeuvres, however, are always the driver's responsibility. While carrying out these manoeuvres, always make sure that no people (especially children) or animals are in the area concerned. Parking sensors are designed to assist drivers: anyway, you must always pay the utmost attention during potentially dangerous manoeuvres, even when these are carried out at a low speed.

MAGIC PARKING

(for versions/markets, where provided)

The Magic Parking system notifies the driver of a free parallel parking space that is a suitable length for the vehicle; it helps the driver when manoeuvring by automatically managing the movement of the steering wheel.



The ultimate responsibility when parking, however, always rests with the driver. During the entire manoeuvre it always necessary to make sure that there are no people or animals in the space.



Parking sensors are a driving aid for the driver, who should continuously pay attention to all potentially dangerous manoeuvres, even at low speed: the Magic Parking system DOES NOT adjust the vehicle speed in manoeuvres; the control of the acceleration speed and braking remain the responsibility of the driver.

During the manoeuvre the driver is also assisted by information from the parking sensors (4 front and 4 rear) which provide further distance information when approaching obstacles in front of and behind the vehicle.

When looking for a parking space it is helpful if the front and rear sensors are not activated, whilst during the manoeuvre, the front and rear sensors will be automatically activated when reverse gear is engaged.



SENSORS

While searching for a parking place, the system uses side sensors (see fig. 78).

These sensors are automatically activated below around 30 km/h; during this stage if the driver has just passed a space that might be useful for a manoeuvre, the function can be requested using the special button; at this point the instructions for carrying out the manoeuvre will be shown on the display. If the function is not requested by the driver using the special button, no information will be displayed on the instrument panel.

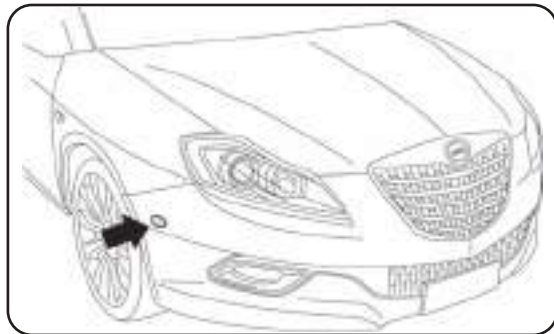

fig. 78

L0E0296m

OPERATION

The assisted parking manoeuvre can only be activated with the instrument panel on and at speeds below about 30 km/h. It is divided into the following stages:

○ **Activation:** pressing the button fig. 79 activates the search stage.

○ **Search:** through side sensors, the system continuously searches for a free parking space, suitable to the vehicle dimensions. The driver determines on which side of the road they intend to park using the direction indicators (if no information is available from the direction indicators or hazard warning lights, the search takes place on the passenger side).

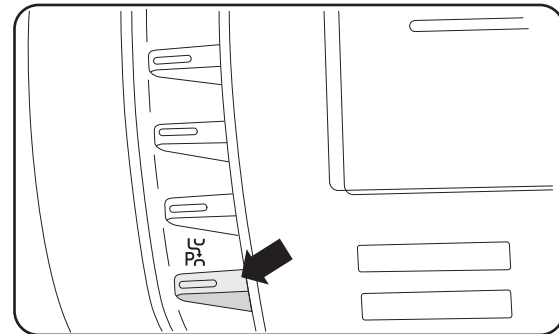

fig. 79

L0E0241m

IMPORTANT The SEARCH stage in the system logic is deactivated after about 10 mins if a suitable parking space is not identified.

○ **Identification:** if the system identifies a free parking space that is a suitable size for the vehicle, it signals its presence and indicates the actions required for starting the manoeuvre.

○ **Manoeuvre:** the driver is asked to engage reverse gear and release the steering wheel and manage the accelerator, brake and clutch (in case of manual gearbox) or accelerator and brake (in case of automatic transmission). During the reverse parking manoeuvre, the system manages the steering wheel automatically.

It suggests that the manoeuvre be concluded in reverse gear (if the conditions permit) when the continuous sound of the buzzer for the rear sensors is heard.

IMPORTANT The MANOEUVRE stage in the system logic is deactivated after about 3 mins if the parking manoeuvre has not been completed.

○ **Manoeuvre end:** if the parking space is sufficient, the parking manoeuvre is completed by the system in a single movement; the further intervention of the driver is not required to position the vehicle. If further corrective manoeuvres are required, the system gives back control to the driver who must complete parking manually.

IMPORTANT Steering will be realigned after reversing when reverse gear is disengaged. The driver must complete the manoeuvre manually.



The operation of the parking assistance is based on different components:

- *front and rear parking sensors;*
- *side sensors;*
- *steering;*
- *wheels and braking system;*
- *instrument panel.*

It is necessary to bear in mind that a malfunction in one of these systems could compromise the operation of the Magic Parking system.



DESCRIPTION OF MANOEUVRING STAGES

Activation

The system is activated by pressing the  button and, as soon as it is activated, the system starts the search stage. The LED in the button coming on indicates that the system is activated. Since the system recognises parking spaces even when it is deactivated, the system can be activated straight away after having driven past an adjacent parking space that is deemed suitable. If the system has effectively identified a parking space, the search stage will not be performed and the system will notify the driver of the operations required to carry out the manoeuvre.

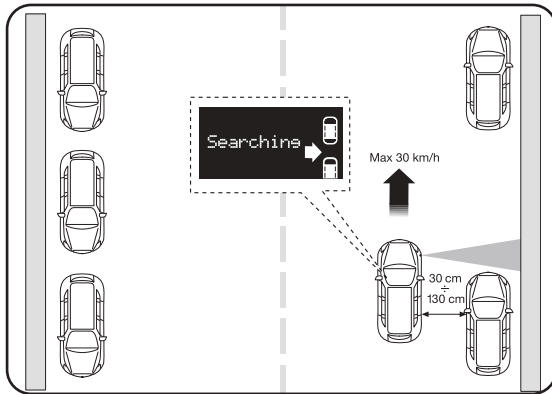

fig. 80

L0E1015g

Search for a parking space

During the search stage fig. 80 the vehicle should continue following its route at a speed lower than approximately 30 km/h and at a distance of around 50 cm to 130 cm from parked cars. A parking space is considered suitable if it is about 130 cm longer than the dimensions of the vehicle.

There are two possible types of parking:

- *parking space about 160 cm longer than the dimensions of the car:* parking can take place in a single manoeuvre;
- *parking space about 130 cm longer than the dimensions of the car:* parking in more than one manoeuvre, where only the first one can be carried out by automatic steering management (the subsequent manoeuvres are entirely the responsibility of the driver).

To select the search and manoeuvring side, the driver must:

- 1) ⇨ Choose to carry out the search for the space and the manoeuvre on the passenger side with:
 - the direction indicator in the middle position;
 - the hazard warning lights on;
 - the hazard warning lights on and the direction indicator in the passenger side position;
 - the direction indicator pointing towards the passenger side.
- 2) ⇐ Choose to carry out the search for the space and the manoeuvre on the driver side with:
 - the direction indicator in the driver's side position;
 - the hazard warning lights on and the direction indicator in the driver side position;

The system will notify the driver, on the side in which the search and the manoeuvre are taking place by means of dedicated messages in the instrument panel display and the symbols (⇐ and ⇨) different on the right and left sides.

The search will, however, take place on both sides, therefore it is possible to make the selection using the direction indicators even when having just driven past a parking space that is deemed suitable.

During the search stage, the speed must not exceed 30 km/h; when 25 km/h have been reached, the driver is signalled to decrease the speed; if a speed of 30 km/h is exceeded, the system is deactivated; in this case, the system must be restarted by pressing the button .

If the Lane crossing function is activated (see “Exterior lights” paragraph) the search for the parking space always takes place on the passenger side.

If the parking sensors are activated during the search for a parking space (see “Front and rear parking sensors” paragraph), the operation of the Magic Parking system is deactivated.



The search for the parking space and the parking manoeuvres must be carried out in compliance with the current regulations of the Highway Code.



Identifying a parking space fig. 81

If the system identifies a suitable parking space between two stationary vehicles or between other obstacles (e.g. objects with an extensive side surface such as vehicles, boxes, etc.) it will indicate that it has found a space and that parking is possible. If the position reached is already suitable at the beginning of the manoeuvre, the system will advise the driver to engage reverse gear, otherwise it will request moving further forward.

On the request to engage reverse gear the driver should stop the vehicle and engage reverse in order to confirm the wish to start the manoeuvre; if the driver continues driving, after about 10 metres the system will no longer consider the parking space identified and will start the search for new suitable space.

Manoeuvre

The driver will have control over the movements of the vehicle using the accelerator, brake and clutch (only on versions with manual gearbox) whilst the system will automatically manage the steering to enter the parking space identified in the best possible way.

During the manoeuvre it will be possible to take advantage of the information coming from the parking sensors (when reversing it is advisable to reach the area where the rear sensors provide a continuous tone signal), but it is always advisable to keep an eye on the surrounding area.

The vehicle can be stopped during the manoeuvre and, whilst remaining stationary, reverse gear can temporarily be released (for example, to allow a pedestrian to go by in the area of the manoeuvre).

The speed should be less than about 7 km/h during the manoeuvre, otherwise the parking manoeuvre will be interrupted.

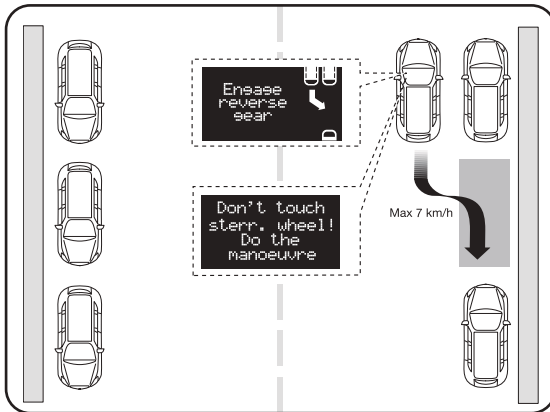

fig. 81

L0E1016g

If the driver carries out a voluntary or involuntary action on the steering during the parking manoeuvre (touching it or preventing its movement), the manoeuvre will be interrupted.

If the road surface is very uneven or there are obstacles under the wheels affecting the movement of the vehicle, preventing it from continuing along the correct trajectory, the manoeuvre may be interrupted.

End of manoeuvre

If the size of parking space permits, the parking manoeuvre may be performed in one go; when reverse gear is released the wheels will be realigned and the manoeuvre will be considered completed; the system will consequently be deactivated. If the size of the parking space is smaller, parking may require several manoeuvres: the driver will be advised to complete the parking manoeuvre manually through a dedicated message on the instrument panel display.



If you wish to stop the steering wheel with your hands during a manoeuvre, it is advisable to handle it firmly on the outer rim. Do not try and keep your hands on the inside or hold the spokes.





General warnings

- The ultimate responsibility when parking, however, always rests with the driver. During these manoeuvres, always make sure that no people, animals or objects are within the manoeuvring area. The Magic Parking system (like parking sensors) is designed to assist drivers: in all cases, you must always pay the utmost attention during potentially dangerous manoeuvres, even when these are carried out a low speed:
- If the sensors undergo shocks influencing their position, the system operation could be strongly degraded.
- If the sensors are dirty, covered by snow, ice or mud or are repainted compared to the original conditions, the system operation could be strongly degraded.
- It is extremely important, for the correct operation of the system, that the sensors are always kept clean. During cleaning, make sure not to scratch or damage them; avoid using dry or rough cloths. The sensors must be washed using clean water, with the addition of car shampoo if necessary. When using special washing equipment such as high pressure jets or steam cleaning, clean the sensors very quickly keeping the jet more than 10 cm away.



- Ultrasound source (e.g. pneumatic brakes of trucks or air drills) nearby could negatively influence the sensor performance.
- Sensors may detect a non-existent obstacle (echo interference) due to mechanical interference, for example while washing the car, rain, strong wind, hail.
- The sensors might not detect objects of a particular shape or made from particular materials (very thin poles, trailer beams, panels, nets, bushes, parking deterrents, rubbish bins, motor vehicles, etc.). Always take great care, checking that the car and its path are effectively compatible with the parking area identified by the system.
- The use of (one or more) tyres or rims of a different size to those present when the vehicle was purchased could affect the operation of the system.
- If the battery is disconnected or very run down, before the Magic Parking system is available it is necessary to drive a few hundred metres, not in a straight line, to initialise the system.
- If a trailer is fitted (with the plug correctly inserted) the Magic Parking system will automatically be disabled.
- If the Magic Parking system is in “search in progress” mode, the system could incorrectly identify a parking space and carry out the manoeuvre (e.g. by a junction, carriage track, roads crossing the direction of travel, etc.)
- In the case of parking manoeuvres on roads on a gradient, the performance of the system could be inferior and it may deactivate.
- If a parking manoeuvre is being carried out between two vehicles parked on the pavement, the Magic Parking system may cause the vehicle to mount the pavement.
- Some manoeuvres at very tight bends may not be carried out.
- Take great care to ensure that conditions do not change during the parking manoeuvre (e.g. if there are persons and/or animals in the parking area, moving vehicles, etc.) and intervene immediately if necessary.
- During parking manoeuvres, pay special attention to vehicles approaching from the opposite direction. Always follow the Highway Code.

SYSTEM MESSAGES ON THE INSTRUMENT PANEL

	<p>The Magic Parking system is searching for a suitable parking space.</p>	<p>Release reverse gear</p>	<p>When the Magic Parking activation button is pressed, reverse gear must be released for the system to be switched on.</p>
	<p>The Magic Parking system is searching for a suitable parking space.</p>	<p>Do not touch the steering wheel!</p>	<p>The manoeuvre is about to begin, the driver is invited to let go of the steering wheel.</p>
	<p>The Magic Parking system is searching for a suitable parking space.</p>	<p>Do not touch the steering wheel! Carry out the manoeuvre</p>	<p>The manoeuvre has started, the driver can accelerate and release the clutch (in the case of a manual gearbox) to enter the parking space; the Magic Parking system will manage the steering automatically.</p>
	<p>A suitable parking space has been identified and the position is correct for starting the parking manoeuvre. It is necessary to stop and engage reverse gear.</p>	<p>Speed too high</p>	<p>The speed of the vehicle is about to exceed the maximum speed permitted by the system (the message will be displayed at about 25 km/h for the search stage), if the driver increases the speed further, the system will automatically be deactivated.</p>

IMPORTANT Some messages displayed are accompanied by acoustic warnings.



Magic Parking not available:	A problem has been detected in the Magic Parking system. Go to an authorised service centre.
Try again later	The Magic Parking system has detected a problem in one of the systems required for its operation. If the problem persists, go to an authorised service centre.
Action on the steering wheel	The driver voluntarily or involuntarily interacted with the steering wheel. The system is disabled and the manoeuvre is controlled by the driver again.
Magic Parking OFF	The Magic Parking system is deactivated for one of the following conditions: manoeuvre concluded, speed limits exceeded, presence of a trailer, search stage too long, manoeuvre stage too long, use of parking sensors requested during the search stage, incorrect vehicle trajectory as a result of obstacles at the wheels.

End Manually	<ul style="list-style-type: none"> ○ The stage managed by the Magic Parking is over, but the parking manoeuvre still needs to be completed by the driver. ○ The steering wheel has been grasped during the manoeuvre. ○ The reverse has been disengaged during the manoeuvre and the vehicle has moved off. ○ Due to obstacles to the wheel movement, the path followed by the vehicle is different from the one required for the parking.
Presence of a Trailer	The activation of the Magic Parking system was requested, but there is a trailer present (the trailer plug is correctly inserted).
Magic Parking off	The Magic Parking system has been switched off following a request to activate the parking sensors during the search stage with the vehicle speed below 15 km/h.

IMPORTANT Some messages displayed are accompanied by acoustic warnings.

FRONT AND REAR PARKING SENSORS (combined with Magic Parking)

(for versions/markets, where provided)

The parking sensors provide the driver with distance information when approaching obstacles in front of and behind the vehicle (versions with 4 front and 4 rear sensors). They are always combined with the Magic Parking function. The system therefore provides a further aid during parking manoeuvres because it allows the identification of obstacles outside of the driver's field of vision.

The driver is notified of the presence and distance of the obstacle from the car by an acoustic signal with a frequency which varies depending on the distance from the obstacle (as the distance from the obstacle decreases the frequency of the acoustic signal increases).

SENSORS

In order to measure the distance of obstacles, the system uses 4 sensors located in the front bumper (where provided) fig. 82 and 4 sensors located in the rear bumper (fig. 83).

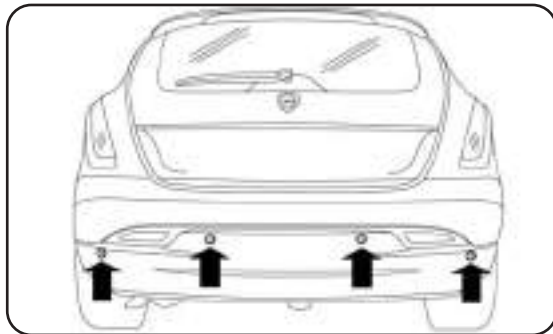

fig. 82

LOE0059m

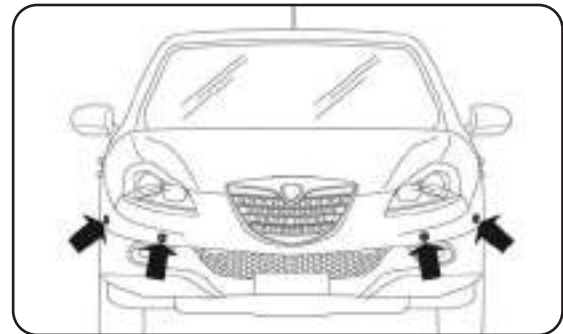



fig. 83

LOE029Sm



Version with 8 sensors

On the version with 4 front sensors and 4 rear sensors, the system is activated when reverse gear is engaged or by pressing the button  fig. 84. If there has been a request to activate the Magic Parking function, the front and rear sensors are not automatically activated during the search for a parking space, but can be activated by pressing the special button  or by engaging reverse gear when the speed is below around 15 km/h.

When reverse gear is released, the front and rear sensors remain activated until a speed of around 15 km/h is exceeded to allow the parking manoeuvre to be completed.

The system can also be activated by pressing the button  in the central panel: a warning light in the button switches on when the system is activated.

The sensors are deactivated by pressing the button  again or when a speed of 15 km/h is exceeded: the

warning light in the button is off when the system is not active.

When the sensors are activated, the system starts to produce acoustic signals from the front or rear buzzers as soon as an obstacle is detected with the frequency increasing as the obstacle gets closer.

When the obstacle is less than about 30 cm away, the sound becomes continuous. Depending on the position of the obstacle (in front or behind) the sound is emitted by the corresponding buzzers (front or rear). The obstacle closest to the car is signalled.

The acoustic signal stops immediately if the distance of the obstacle increases. The sound cycle remains constant if the distance measured by the centre sensors remains unchanged, whilst if this situation occurs for the side sensors, the signal is interrupted after about 3 seconds (for example, to prevent signals in the case of manoeuvres alongside walls).

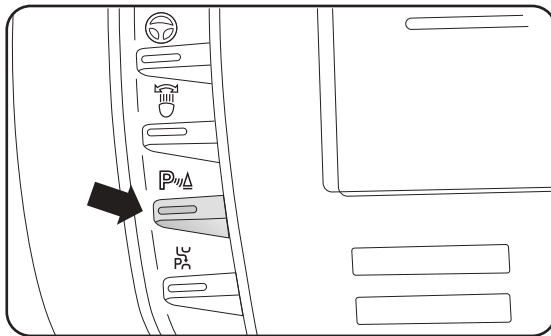

fig. 84

LOE0249m



The responsibility for parking and other dangerous manoeuvres always and in every case lies with the driver. While carrying out these manoeuvres, always make sure that no people (especially children) or animals are in the area concerned. Parking sensors are designed to assist drivers: in all cases, you must always pay the utmost attention during potentially dangerous manoeuvres, even when these are carried out a low speed.

ACOUSTIC SIGNAL

The information concerning the presence and distance of an obstacle from the car is transmitted to the driver by means of acoustic signals from 2 buzzers installed in the passenger compartment:

- a front buzzer warns of the presence of obstacles at the front and a buzzer located at the rear warns of the presence of obstacles at the rear. This permits the driver to perceive the direction (front/rear) of the obstacles.

Operation is automatically activated when reverse gear is engaged.

The acoustic signal:

- increases as the distance between the car and the obstacle decreases;
- becomes continuous when the distance between the car and the obstacle is less than around 30 cm and stops immediately if the distance increases;
- is constant if the distance is unvaried; if this situation occurs for the side sensors, the indication will stop after about 3 seconds to avoid, for example, warning indications in the event of manoeuvres alongside walls.



The sensor must be clean of mud, dirt, snow or ice in order for the system to operate correctly. Be careful not to scratch or damage the sensors while cleaning them. Avoid using dry, rough or hard cloths. The sensors must be washed using clean water, with the addition of car shampoo if necessary. When using special washing equipment such as high pressure jets or steam cleaning, clean the sensors very quickly keeping the jet more than 10 cm away.



Only have the bumpers repainted or any retouches to the paintwork in the area of the sensors carried out by a Lancia Dealership. If the paint is incorrectly applied this could adversely affect the operation of the parking sensors.

SENSOR OPERATING RANGE

The sensors allow the system to check the front part (version with 8 sensors) and rear part of the vehicle.

Their position covers the middle and side areas of the front and rear of the car. If an obstacle is located in a middle area, it is detected when the distance is less than about 0.9 m (front) and 1.30 m (rear).

If the obstacle is located at the side, it is detected at distances of less than 0.6 m.





OPERATION WITH TRAILER

The operation of the sensors is automatically deactivated when the trailer's electric plug is inserted in the car's tow hook socket. The sensors are automatically reactivated when the trailer's cable plug is removed.

IMPORTANT If you wish to leave the tow hook fitted when there is no trailer, it is advisable to go to a Lancia Dealership to have the system updated because the tow hook could be detected as an obstacle by the centre sensors.

FAULT INDICATIONS

Either symbol  (if the Magic Parking system is fitted), or symbol  (if the Magic Parking is not fitted) will light up on the display in combination with a message or with instrument panel  warning light if parking sensor faults are detected while reverse is engaged.

IMPORTANT INFORMATION

During parking manoeuvres, pay the utmost attention to any obstacles that could be located above or below the sensors.

Under certain circumstances close objects located in front of or behind the vehicle may not be detected and could therefore cause damage to the vehicle or be damaged themselves.

The following conditions may influence the performance of the parking assistance system:

- Reduced sensor sensitivity and a reduction in the parking assistance system performance could be due to the presence on the surface of the sensors of: ice, snow, mud, thick paint.
- The sensors detect a non-existent obstacle (echo interference) due to mechanical interference, for example when washing the vehicle, rain (strong wind), hail.
- The indications sent by the sensors can also be altered by the presence of ultrasonic devices (e.g. truck pneumatic brake systems or pneumatic drills) near the car.
- The performance of the parking assistance system may also be affected by the position of the sensors. For example, if the geometry is altered (as a result of wear of the shock absorbers, suspension) or the tyres are changed, the vehicle is too heavily laden, specific tuning is carried out that lowers the vehicle.
- The detection of obstacles to the upper part of the vehicle is not guaranteed as the system is designed to detect obstacles that could impact the lower part of the vehicle.

WIRING FOR RADIO SYSTEM

(for versions/markets, where provided)

If no car radio was requested at the time of purchase, the vehicle is provided with a compartment on the dashboard fig. 85.

The radio setup system is composed of:

- radio power supply cables, front and rear loudspeakers and an aerial;
- car radio housing;
- aerial on car roof.

The radio must be fitted in the special compartment A - fig. 85, which can be removed by pressing the two retaining tabs B in the compartment itself; the power supply cables are located in this area.



For connection to the radio system setup, contact a Lancia Dealership to prevent any problem that could impair car safety.

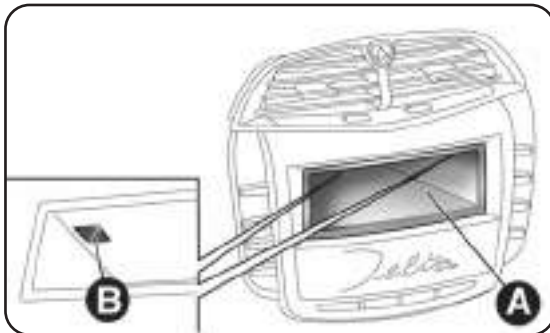

fig. 85

L0E0286m



ACCESSORIES PURCHASED BY THE OWNER

If after buying the car, you decide to install electrical accessories that require a permanent electric supply (radio, satellite anti-theft system, etc.) or accessories that in any case burden the electric supply, contact a Lancia Dealership, whose qualified personnel, besides suggesting the most suitable devices from Lineaccessori Lancia, will also evaluate the overall electric consumption, checking whether the car's electrical system is able to withstand the load required, or whether it needs to be integrated with a more powerful battery.



Take care when fitting additional spoilers, alloy wheels or non-standard wheel hubs: they could reduce the ventilation of the brakes and affect efficiency under sharp, repeated braking or on long descents. Make sure that nothing obstructs the pedal stroke (mats, etc.).

INSTALLING ELECTRICAL/ELECTRONIC DEVICES

The electric/electronic devices installed subsequent to the purchase of the car and included in the after-sales service must be marked:



Fiat Group Automobiles S.p.A. authorises the installation of transceiver devices on condition that such installations are carried out in a workmanlike fashion, following the manufacturer's instructions, at a specialised centre.

IMPORTANT Traffic authorities may not allow the vehicle on the road if devices are fitted that modify vehicle specifications. This may also invalidate the warranty in relation to faults caused by the change or either directly or indirectly related to it. Fiat Group Automobiles S.p.A. shall not be liable for damage caused by the installation of accessories either not supplied or recommended by Fiat Group Automobiles S.p.A. and/or not installed in compliance with the provided instructions.

RADIO TRANSMITTERS AND MOBILE PHONES

Radio transmitter equipment (vehicle mobile phones, CB radios, amateur radio etc.) cannot be used inside the car unless a separate aerial is mounted on the roof.

IMPORTANT The use of such devices inside the passenger compartment (without a separate aerial), may cause the car's electronic systems to malfunction. This could compromise safety in addition to constituting a potential hazard for passengers.

In addition, transmission and reception of these devices may be affected by the shielding effect of the vehicle body. As far as the use of EC-approved mobile phones is concerned (GSM, GPRS, UMTS), follow the usage instructions provided by the mobile phone manufacturer.

REFUELLING THE CAR

OPERATION AT LOW TEMPERATURES

If the outside temperature is very low, diesel thickens due to the formation of paraffin clots with consequent defective operation of the fuel supply system.

In order to avoid these problems, different types of diesel are distributed according to the season: summer type, winter type and arctic type (cold/mountain areas). If refuelling with diesel fuel whose specifications are not suitable for the current temperature, it is advisable to mix TUTELA DIESEL ART additive in the proportions shown on the container. Pour the additive into the tank before the diesel fuel.

When using or parking the vehicle for a long time in the mountains or cold areas, it is advisable to refuel using locally available diesel fuel.

In this case, it is also advisable to keep the tank over 50% full.



For diesel engines, only use diesel fuel for motor vehicles in accordance with EN590 European specifications. The use of other products or mixtures may damage the engine beyond repair and consequently invalidate the warranty; due to the damage caused. If you accidentally refuel with another type of fuel, do not start the engine, and drain the tank. If the engine has run, even for a very short time, you will need to have the entire fuel supply system emptied in addition to the tank.

FILLING THE TANK

To fill the tank completely, top-up twice after the first click of the fuel supply gun. Further top-ups could cause failures in the fuel supply system.

FUEL FILLER CAP fig. 86

To refuel, press flap A to release it and access the fuel tank cap. The flap is locked with the central locking on. Undo cap B which has a device C retaining it to the flap so it cannot be lost. The sealing may cause a slight pressure increase in the tank. A little breathing off, while slackening the cap is absolutely normal. When refuelling, attach the cap to the device inside the flap as shown in the figure.



Do not bring naked flames or lit cigarettes near the fuel tank filler: fire risk. Keep your face away from the fuel filler to prevent breathing in harmful vapours.

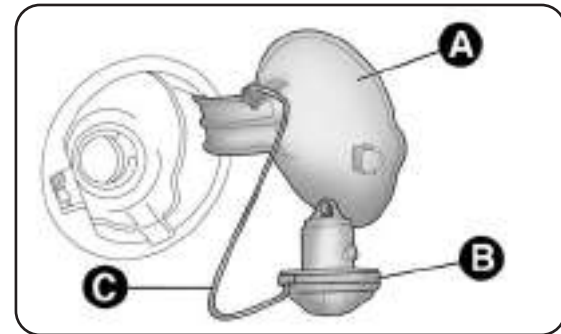

fig. 86

L0E0060m

OPENING THE FUEL CAP IN AN EMERGENCY

In case of emergency, pull the cord A - fig. 87. Remove the cover to access the cord.

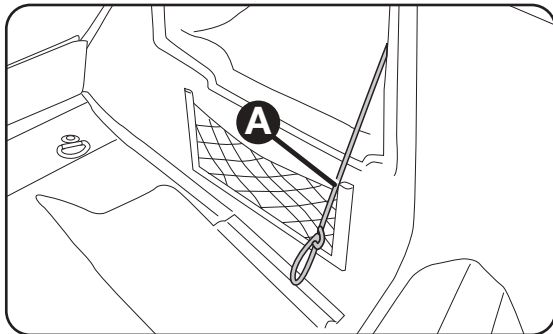

fig. 87

LOED1S4m

PROTECTING THE ENVIRONMENT

The following devices are used for reducing emissions:

- oxidizing catalytic converter;
- exhaust gas recirculation system (EGR).
- diesel particulate filter (DPF) (for versions/markets, where provided).



Under normal operating conditions, the catalytic converter becomes very hot. Do not park the vehicle on grass, dry leaves, pine needles or other flammable material: fire hazard.



DIESEL PARTICULATE FILTER (DPF) (for versions/markets where provided)

The Diesel Particulate Filter is a mechanical filter, integral with the exhaust system, that physically traps carbon particles present in the exhaust gases of diesel engines. The diesel particulate filter has been adopted to eliminate almost all carbon particles in compliance with current / future legal regulations. During normal use of the vehicle, the engine control unit records a set of data (e.g.: travel time, type of route, temperatures, etc.) and it will then calculate how much particulate has been trapped by the filter.

Since this filter physically traps particulate, it should be regenerated (cleaned) at regular intervals by burning carbon particles. The regeneration procedure is controlled automatically by the engine management control unit according to the filter conditions and vehicle use conditions. During regeneration, the following may occur: a limited increase in the engine speed, activation of the fan, a limited increase in fumes and high temperatures at the exhaust. These are not faults; they do not impair vehicle performance nor damage the environment. If the dedicated message is displayed, refer to the “Instrument panel warning lights” paragraph in this chapter.

blank page



Seat belts	156
SBR system.....	157
Pretensioners	158
Carrying children safely	161
Fitting the “Universal” child restraint system	163
“Isofix” child restraint system setup	169
Front Airbags	173
Side bags (Side bag - Window bag)	178

SEAT BELTS

USING THE SEAT BELTS **fig. 1**

The seat belt should be worn keeping the torso straight and rested against the backrest.

To fasten the seat belts, hold the tongue **A** and insert it into the buckle **B**, until it clicks into place. If the seat belt jams during removal, let it rewind for a short stretch, then pull it out again without jerking.

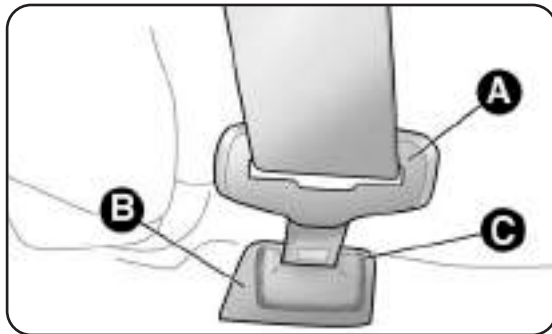

fig. 1

LOE0061m

To unfasten the seat belts, press button **C**. Guide the seat belt with your hand while it is rewinding, to prevent it from twisting. Through the retractor, the seat belt automatically adapts to the body of the occupant wearing it, allowing freedom of movement.



Never press button C when travelling.

The retractor may lock when the car is parked on a steep slope: this is normal. Furthermore, the retractor mechanism locks the belt if it is pulled sharply or in the event of sudden braking, collisions and high-speed bends. The rear seat is fitted with inertia seat belts with three anchor points and a retractor.

The rear seat belts must be used as shown in the diagram in **fig. 2**.



Remember that, in the event of a violent collision, back-seat passengers not wearing seat belts represent a serious danger to the front-seat passengers as well as to themselves.





IMPORTANT After putting the seats back to their travelling position, restore the seat belt position to make them ready for use.

IMPORTANT If the rear seat is being moved and this causes the middle seat belt to lock temporarily, normal conditions can be restored simply by moving the seat towards the back of the car.

SBR SYSTEM

The car is provided with the SBR (Seat Belt Reminder) system, which warns the driver and the front passenger if the seat belt is not fastened, as follows:

- warning light  turns on constantly and continuous activation of the acoustic signal for the first 6 seconds;
- warning light  flashes and the acoustic signal sounds intermittently for the next 96 seconds.

For long-term deactivation of the SBR system, contact a Lancia Dealership.

The SBR system can be reactivated at any time through the display Setup Menu (see chapter “1”).

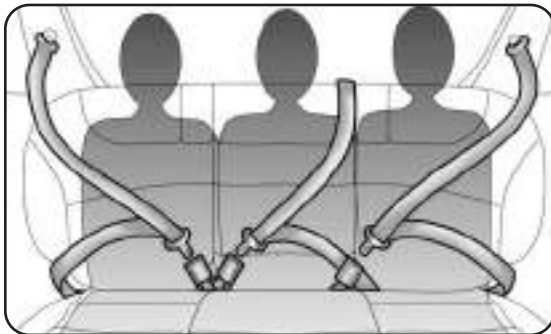

fig. 2

L0E0062m

PRETENSIONERS

The car is equipped with front seat belt pretensioners in case of a severe frontal impact. This guarantees the perfect adherence of the seat belts to the occupants' bodies before the restraining action begins.

It is evident that the pretensioners have operated when the belt withdraws toward the retractor.

This car is also equipped with a second pretensioner (fitted in the kick plate area). Its activation is signalled by the shortening of the metal cable.

A slight discharge of smoke may be produced during the activation of the pretensioner which is not harmful and does not indicate any fire hazard.

IMPORTANT To obtain the highest degree of protection from the action of the pretensioner, wear the seat belt tight to the chest and pelvis.

The pretensioner does not require any maintenance or lubrication: any changes to its original conditions will invalidate its efficiency. If, due to unusual natural events (floods, sea storms, etc.), the device has been affected by water and mud, it must be replaced.



The pretensioner may be used only once. Go to a Lancia Dealership to have it replaced after it has been deployed.



Operations which lead to impacts, vibrations or localised heating (over 100°C for a maximum of six hours) in the area around the pretensioner may damage or deploy it. Contact a Lancia Dealership should intervention be necessary on these components.

LOAD LIMITERS

To increase passenger safety, the retractors contain a device which doses the force acting on the chest and shoulders during the belts' restraining action in the event of front collisions.



GENERAL INSTRUCTIONS FOR USING THE SEAT BELTS

The driver is responsible for complying with, and ensuring that all the other occupants of the car also comply with, the local laws in force in relation to the use of the seat belts. Always fasten the seat belts before setting off.

Seat belts are also to be worn by pregnant women: the risk of injury in the case of impact is greatly reduced for them and the unborn child if they are wearing a seat belt.

Pregnant women must position the lower part of the belt very low down so that it passes over the pelvis and under the abdomen (see fig. 3). The best way to protect the unborn child is to protect the mother. When a safety belt is worn properly, it is more likely that the unborn child will not be hurt in a crash. For pregnant women, as for anyone, the key to making safety belts effective is wearing them properly.



For maximum protection, keep the backrest upright, lean back into it and make sure the seat belt fits closely across your chest and pelvis. Always fasten the seat belts on both the front and the rear seats! Travelling without wearing seat belts will increase the risk of serious injury and even death in the event of an accident.



Removing or otherwise tampering with seat belt and pretensioner components is strictly prohibited. Any operations on these components must be performed by qualified and authorised technicians. Always go to a Lancia Dealership.

The belt must not be twisted. The upper part must pass over the shoulder and cross the chest diagonally. The lower part must fit over the pelvis (as shown in fig. 4) rather than the abdomen of the passenger.

Never use devices (clips, clamps, etc.) to hold the seat belt away from your body.

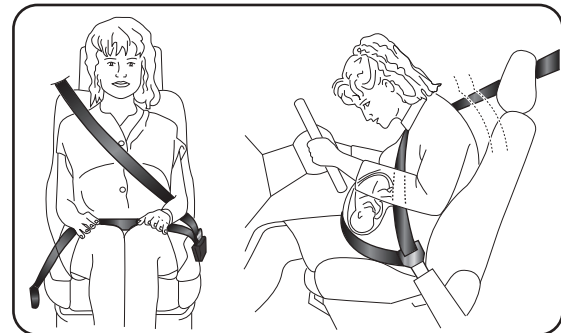

fig. 3

LOE0404m

Each seat belt must be used by only one person. Never travel with a child sitting on the passenger's lap using the seat belts to protect them both, fig. 5.
Do not fasten any other object to the body.



If the belt has been subjected to a high level of stress, for example after an accident, it must be completely replaced together with the attachments, attachment fixing screws and the pretensioner. In fact, even if the belt has no visible defects, it could have lost its resilience.

SEAT BELT MAINTENANCE

For keeping the seat belts in efficient conditions, observe the following:

- always make sure the belt is well stretched and never twisted; make sure that it is free to run without obstructions;
- check seat belt operation as follows: attach the seat belt and pull it hard;
- replace the belt after an accident of a certain severity even if it does not appear to be damaged. Always replace the seat belt if the pretensioners were deployed;
- to clean seat belts, wash by hand with water and mild soap, rinse and leave to dry in the shade. Never use strong detergents, bleach, paints or any other substance which could damage the belt fibres;

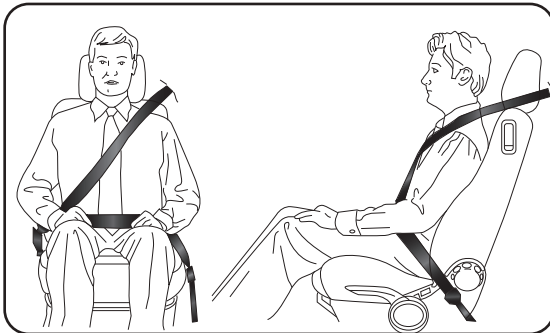

fig. 4

L0E0403m

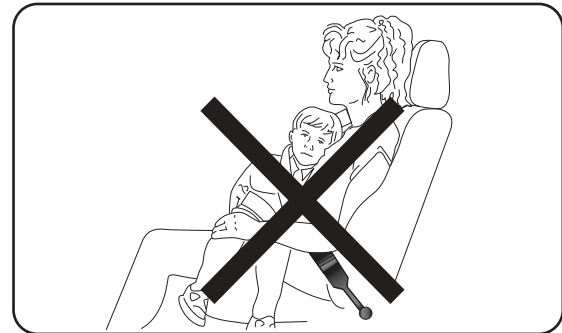

fig. 5

L0E0405m



- prevent the retractors from getting wet: their correct operation is only guaranteed if water does not get inside;
- replace the seat belt when it shows significant wear or cuts.
- replace the seat belt when it demonstrates significant wear or cuts.

CARRYING CHILDREN SAFELY

For optimal protection in the event of an impact, all occupants must be seated and wearing adequate restraint systems, including newborn and other children!

This prescription is compulsory in all EC countries according to EC Directive 2003/20/EC. Compared with an adult, a child's head is larger and heavier in proportion to his/her body and the child's muscular and bone structures are not fully developed. Therefore, correct restraint systems other than adult seat belts are necessary to reduce as much as possible the risk of injuries in the event of an accident, braking or a sudden manoeuvre.

Children must be seated safely and comfortably. As far as the characteristics of the child restraint systems used allow, you are advised to keep children in rear facing restraint systems for as long as possible (at least until 2 years old), since this is the most protected position in the event of an impact. The choice of the most suitable child restraint device depends on the weight of the child; there are various types of child restraint systems and you are advised always to choose the one that is most suitable for the child.

When over 1.50 m in height, from the point of view of restraint systems, children are considered as adults and wear seat belts normally.

In Europe the characteristics of children restraint systems are ruled by the regulation ECE-R44, dividing them into five weight groups:

Group	Weight range
Group 0	up to 10 kg
Group 0+	up to 13 kg
Group 1	9-18 kg
Group 2	15-25 kg
Group 3	22-36 kg

All restraint devices must bear the type-approval data along with the control mark on a fixed label which must never be removed in any circumstances. Lineaccessori Lancia includes child restraint systems for each weight group. These devices are recommended, having been specifically designed for Lancia cars.



On the sun visor there is a label with suitable symbols to remind you that it is compulsory to deactivate the airbag if a rear facing child restraint system is fitted. Always comply with the instructions on the passenger's side sun visor (see the "Front Airbags" paragraph).



Should it be necessary to carry a child on the passenger side front seat in a rear facing child restraint system, the passenger side front airbag and side bag (for versions/markets, where provided) must be deactivated through the Setup menu. Deactivation should be verified by checking whether the warning light is switched on in the instrument panel. Move the passenger's seat as far back as possible to avoid contact between the child restraint system and the dashboard.



Do not move the front or rear seat if a child is seated on it or on the dedicated child restraint system.



FITTING THE “UNIVERSAL” CHILD RESTRAINT SYSTEM (with seat belts)

GROUP 0 and 0+



The diagram is indicative and for fitting purposes only. Refer to the instructions which must be supplied with the child restraint system.

Children up to 13 kg must be carried with rear-facing restraint system of a type as shown in fig. 4 which, supporting the head, does not induce stress on the neck in the event of sudden decelerations.

The restraint system is restrained by the car seat belts as shown in fig. 6 and it must restrain the child in turn with its own belts.

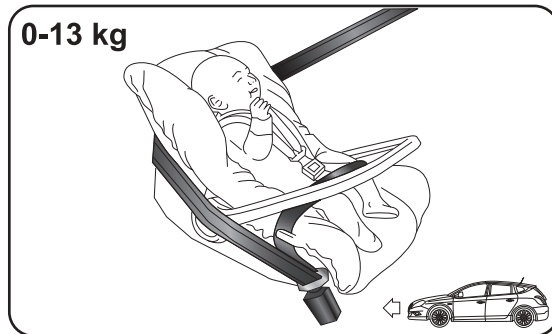

fig. 6

L0E0407m

GROUP 1



The diagram is indicative and for fitting purposes only. Refer to the instructions which must be supplied with the child restraint system.

Children from 9 to 18 kg may be carried in forward facing child restraint systems fig. 7.



Child restraint systems with Isofix attachments are available, which allow them to be secured to the seat safely without using the car seat belts. For this type of seats see paragraph “ISOFIX child restraint system setup” in this chapter.

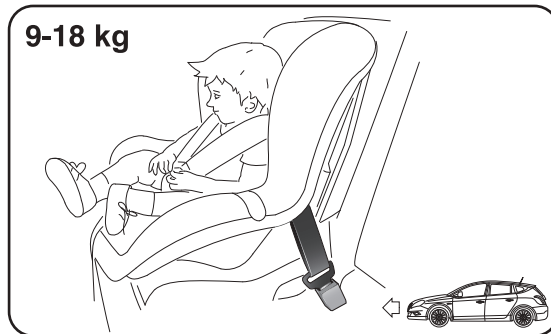

fig. 7

L0E0408m

**GROUP 2**

The diagram is indicative and for fitting purposes only. Refer to the instructions which must be supplied with the child restraint system.

In this case, the child restraint system is used only to position the child correctly with respect to the seat belts so that the diagonal belt section crosses the child's chest and not the neck, and the lower part is snug on the pelvis, not the abdomen.

Children from 15 to 25 kg may use the car seat belts directly, fig. 8.

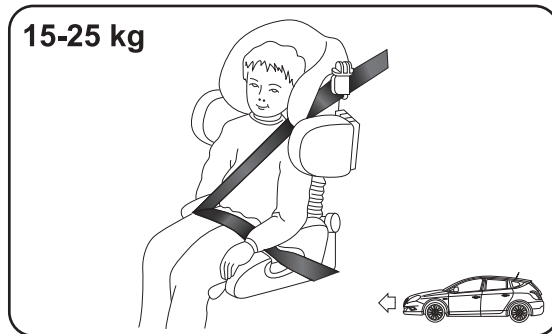
2**fig. 8**

L0E0409m

GROUP 3



The diagram is indicative and for fitting purposes only. Refer to the instructions which must be supplied with the child restraint system.

For children between 22 kg and 36 kg, there are dedicated restraint systems that allow the seat belt to be worn correctly.

Figure 9 shows correct child seat positioning on the rear seat. Children over 1.50 m in height can wear seat belts like adults.

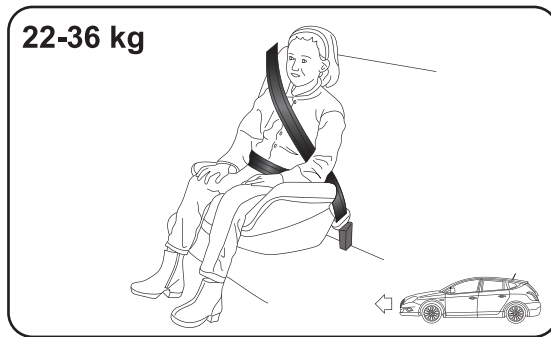

fig. 9

L0E0410m



PASSENGER SEAT COMPLIANCE WITH REGULATIONS ON UNIVERSAL CHILD RESTRAINT SYSTEM USE

The car complies with the new European Directive 2000/3/EC which governs the arrangement possibilities for child restraint systems on the various seats of the car as shown in the following table:

Versions without rear fixed seat

Group	Weight range	Front passenger	Rear side passenger	Rear central passenger
Groups 0, 0+	up to 13 kg	U	U (*)	X
Group 1	9–18 kg	U	U (*)	X
Group 2	15–25 kg	U	U (*)	X
Group 3	22–36 kg	U	U (*)	X

Key:

U = suitable for restraint systems in the “Universal” category, according to European Regulation ECE-R44 for the specified “Groups”.

(*) The rear seat backrest must be in the vertical position.

X = Seat not suitable for children in this weight category.

Versions with rear fixed seat

Group	Weight range	Front passenger	Rear side passenger (passenger side)	Rear central passenger	Rear side passenger (driver side)
Groups 0, 0+	up to 13 kg	U	U	U	X
Group 1	9–18 kg	U	U	U	X
Group 2	15–25 kg	U	U	U	X
Group 3	22–36 kg	U	U	U	X

Key:

U = suitable for restraint systems in the “Universal” category, according to European Regulation ECE-R44 for the specified “Groups”.

X = Seat not suitable for children in this weight category.



“ISOFIX” CHILD RESTRAINT SYSTEM SETUP

The car is equipped with ISOFIX anchorages, a new standard which makes fitting a child restraint system quick, simple and safe.

It is possible to fit a mix of traditional and Isofix child restraint systems on different seats in the same car.

An example of a Universal Isofix child restraint system for weight group 1 is shown in fig. 10.



The diagram is indicative and for fitting purposes only. Refer to the instructions which must be supplied with the child restraint system.

The other weight groups are covered by specific Isofix child restraint systems, which can be used only if specifically tested for this car (see list of cars provided with the child restraint system).



fig. 10

L0E0065m

INSTALLING A UNIVERSAL ISOFIX CHILD RESTRAINT SYSTEM

Due to its different anchoring system, the child restraint system must be anchored to the dedicated lower metal rings A - fig. 11, set between rear seat backrest and rear cushion. After removing the parcel shelf, secure the upper

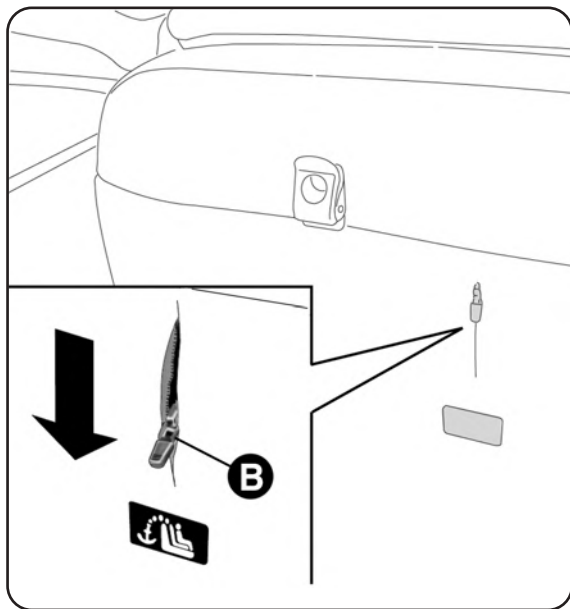

fig. 11

LOE0233m

belt (provided with the child restraint system) to the specific ring (after having opened the covering zip B - fig. 11) located in the rear seat backrest.

Remember that when using a Universal Isofix child restraint system, you can use all type-approved systems with the marking ECE R44 (R44/03 or superior) "Universal Isofix".

The Universal Isofix "Duo Plus" child restraint system and the special "G 0/1" system are available from Lineaccessori Lancia.

For any further details on installation/use, refer to the instruction manual for the child restraint system.



Fit the child restraint system when the car is stationary. The child restraint system is correctly fixed to the brackets when you hear the click. Follow the instructions for assembly, disassembly and positioning that the manufacturer must supply with the child restraint system.



PASSENGER SEAT COMPLIANCE WITH REGULATIONS ON ISOFIX CHILD RESTRAINT SYSTEM USE

The table below shows the various installation possibilities for Isofix child restraint systems on seats fitted with Isofix attachments in accordance with European standard ECE 16.

Weight group	Restraint system orientation	Isofix size class	Rear side passengers
Portable cradle	Side	F-G	IL
Group 0 up to 10 kg	Rear facing	E	IL
Group 0+ up to 13 kg	Rear facing	E	IL
	Rear facing	D	IL
	Rear facing	C	IL
	Rear facing	D	IL
Group 1 from 9 up to 18 kg	Rear facing	C	IL
	Forward facing	B	IUF
	Forward facing	B1	IUF
	Forward facing	A	IUF

IL: suitable for ISOFIX child restraint systems of the “Specific for the vehicle”, “Restricted” or “Semiuniversal” categories, approved for this type of vehicle.

IUF: suitable for forward facing Isofix child restraint systems in the Universal category and approved for use in the weight group.



Fit the child restraint system according to the instructions, which must be included.

Main instructions for carrying children safely:

- Install the child restraint systems on the rear seat, which is the most protected position in the event of an accident.
 - Keep children in rear facing restraint systems for as long as possible, until 3–4 years old if possible.
 - Should a rear facing child restraint system be installed on the rear seats, it is advisable to position it as far forward as the position of the front seat allows.
 - If the front passenger's airbag is deactivated always check that the dedicated warning light is permanently switched on on the instrument panel to make sure that it has actually been deactivated.
 - Carefully follow the instructions supplied with the child restraint system itself. Keep the instructions in the car along with the other documents and this handbook. Do not use second-hand child restraint systems without instructions.
- Only one child is to be strapped to each retaining system; never use it to transport two children at once.
 - Always check that the seat belts do not interfere with the child's throat.
 - Always check that the seat belt is well fastened by pulling on it.
 - While travelling, do not let the child sit incorrectly or unfasten the belts.
 - Never allow a child to put the belt's diagonal section under an arm or behind their back.
 - Never carry children on your lap, even newborns. No-one can restrain a child in the event of an accident.
 - In the event of an accident, replace the child restraint system with a new one.



FRONT AIRBAGS

The car is provided with front airbags for the driver and the passenger, driver's knee bag (for versions/markets where provided) and front side bags (side bags - window bags).

The front airbags (driver, passenger driver's knee bag) protect the occupants of the front seats in the event of moderate to serious front impacts by positioning the bag between the occupant and the steering wheel or the dashboard.

Therefore non-activation in other types of collisions (side collisions, rear shunts, roll-overs, etc.) is not a system malfunction.

An electronic control unit will make the bag inflate in the event of a frontal impact.

The bag will inflate instantaneously placing itself between the front occupants body and the structures which could cause injury. It will deflate immediately afterwards.

The front airbags (driver, passenger, driver knee bag) do not replace but rather complement the seat belts, which you are always advised to wear, as specified by law in Europe and most non-European countries.

In the event of an impact, someone not wearing a seat belt could move forward and come into contact with a bag which is still in the opening phase. The protection offered by the bag is reduced in such a case.

The front airbags may not be activated in the following situations:

- front collisions against highly deformable objects not affecting the front surface of the car (e.g. bumper collision against guard rail, etc.);
- car wedging under other vehicles or protective barriers (e.g. trucks or guard rails).

Failure to activate in the conditions described above is due to the fact that they may not provide any additional protection compared with seat belts, so their activation would be inappropriate. In these cases, non-deployment of the airbag does not necessarily indicate a system malfunction.



Do not apply stickers or other objects on the steering wheel, on the dashboard in the passenger side airbag area, on the side upholstery on the roof and on the seats. Never put objects (e.g. mobile phones) on the passenger side of the dashboard since they could interfere with correct inflation of the passenger airbag and also cause serious injury to the passengers.

The front airbags (driver, passenger, driver's knee bags) are designed and calibrated to protect front seat passengers wearing seat belts.

Their volume at the moment of maximum inflation fills most of the space between the steering wheel and the driver, between the lower post guard and the knees on passenger side and between the dashboard and the passenger.

The airbags are not deployed in the event of minor front collisions (for which the restraining action of the seat belts is sufficient). Safety belts must always be worn. In the event of frontal impact they guarantee correct positioning of the passenger.

FRONT AIRBAG ON DRIVER'S SIDE **fig. 12**

This consists of an instantly inflating bag contained in a special recess in the centre of the steering wheel.

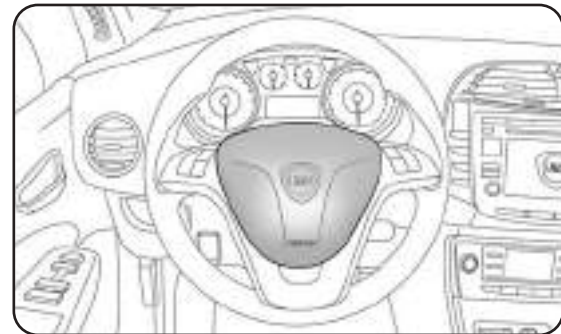

fig. 12



FRONT AIRBAG ON PASSENGER'S SIDE fig. 13

This consists of an instantly inflating bag contained in a special recess in the dashboard: this bag has a larger volume than that of the driver's.

FRONT PASSENGER AIRBAG AND CHILD RESTRAINT SYSTEMS



When an active passenger airbag is fitted, DO NOT install rear facing child restraint systems on the front seat. Deployment of the airbag in an accident could cause fatal injuries to the child regardless of the severity of the collision. ALWAYS comply with the instructions on the label attached to the passenger side sun visor.

2

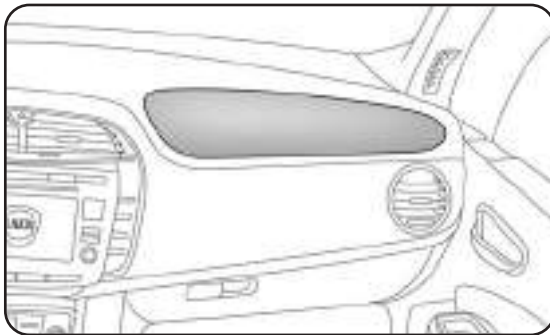

fig. 13

L0E0068m

FRONT PASSENGER AIRBAG AND CHILD RESTRAINT SYSTEMS: WARNING

I	RISCHIO DI FERITE GRAVI O MORTALI. Il ruggine può causare che il bambino nel vostro veicolo è a rischio di morte con vostro veicolo su sedia anteriore in presenza di un bag passeggero attivo.
GB	DEATH OR SERIOUS INJURY CAN OCCUR. NEVER use a rearward facing child restraint on a seat protected by an ACTIVE AIRBAG in front of a DEATH or SERIOUS INJURY to the CHILD can occur.
F	RISQUE DE MORT OU DE BLESSURES GRAVES. NE PAS positionner le siège pour enfant tourné vers l'arrière, en cas d'un bag passager actif.
D	Nachrichtigung kann TOD oder SCHWERE VERLETZUNGEN auf Folge haben. Kindersitz gerichtet Kinderrückhaltesysteme (Rückwärts) dürfen nicht in
NL	Verbodend om achterwaarts Richtingszit op een Beveiligings zitwoning te worden DIT KAN DODLIJK ZIJN OP ERNSTIGE ONGELUKKEN VERORZAAKEN. Ruzi ter kindersitje niet ruggings op de vervoerstoel wanneer er een airbag aanwezig is.
E	RISQUE OCCASIONNAIR MORTS O BLESSURES GRAVES. NE utiliser ni siège pour enfant ni siège avant sur le siège en et siège de sécurité si habillé airbag actif lors passage.
PL	MOŻE ODCIĄC SPECJALNIE LUB CIĘŻKIE OBRAZNIENIA. NIE WOLNO umieszczać fotelika dziecięcego tyłem do kierunku jazdy na przednim siedzeniu w przypadku zamontowania aktywnego pasywnego powietrznej pasażera.
TR	ÖLÜM VYA AĞIR BAKİLE ZARARLILARINA NEDEN OLABİLİR. İleri yönde oturma koltuğu için çocuk koltuğunu arka yöne doğru oturma koltuğuna yerleştirmeyin.
DK	FARE FOR DØDELIGE KVÆTTELSE OG LIVSTRUENDE SKADER. Ruzer aldrig en bagudvendt barnesid på passagerensiden, hvis passagerensiden er udstyret til en vane airbag (ar).
EST	TASAVÄRTE MÕRDU OLLA RASKEID KIRVAVASTAUSI VÕI SURM. Tasavõrd otsustada kindlalt ära istuda lapse rütuvaat istekohale istekohtadele.
FIN	KUOLEMANVAARA TAI RASKAAN VAMMANTUEN VAARAA. Älä aseta lapsen rütuvaatista eteen, ettei laps ei ole istumapaikalla, kun matkustaja airbag on käytössä.
P	RISICO DE MORTE OU FERIMENTOS GRAVES. NÃO positionar o banco para criança nem posição contrária ao sentido de marcha quando o airbag do passageiro estiver ativo.
LT	GLAUSI ISTUKTI BERTIS ARBA GALITE RIMTI SUSEBTI. Nedėkite vaiko sėdėtinio rütuvaat ruzgti į priekini automobilio sėdėtinį ten, kas yra veiksmi kabinai oro pagalvė.
E	KAN VANA LIVMOTANDNE ELLER LIDA TEL ALLVÆRDLIGA SKADOR. Ruzer aldrig en bagudvendt barnesid i forreste af passagerensiden hvis kabinen er udstyret med en vane airbag (ar).
H	HALASOS VAGY SÜROCS BALISZT KÖVETKEZHET BE. Ne helyeznek a gyermekülési a menetiránytól szembe, ha az utas oldalsó léggölg működik.
LV	NEK IRNASTI NĀVIĀNI NĀPĒRTĪBAS TRĀPĀS. Nepozicijonēt mazulā sēdētāji pretī brauciena virzienam, ja pasēdētājam ir uzstādīts gaisa spilvens.
CZ	NEČO NEBEZPEČÍ VAŽNĚHO URUČENÍ NA SPRÁVNĚ NEBO DOPROČNĚ SPĚTI. Neumísťujte dieťa do sedadla do opačnej polohy vzhľadom na smer jazdy a prípadne aktivovanú airbagovú zbraň.
SLO	LAHKO PRIDE DO SMRTI ALI HUIJDIH POŠKODB. Dnevniški avtomobilnega sedelca ne namestite v obratni smeri vožnje, če ima avtomobil opremljen s aktivno zračno
NO	SE KANNE PRUDDRE DØDSELV, SÅU LIVSTRUENDE GRAVE. Ne brukar issestol der bakover retning i bilde foran passasjerenside da vane airbag er aktivert i bilde passasjerenside.
GR	ΜΟΡΤΟΝ ΗΛΙ ΠΡΟΒΛΗΚΟΤΩΝ ΒΑΝΑΤΩΝ Η ΕΒΑΝΑ ΤΡΥΜΑΤΑ. Μην τοποθετείτε το παιδικό σκελετικό για παιδιά με αντίθετη προς τον όπισθεν πορεία στο εμπροσθινό του οχήματος καθίσμα, εάν υπάρχει ενεργός αερόσακος του επιβάτη.
KG	ИМА ВРАЖОСТ ОТ СМРТ И СЕРИОЗНИ НАРАΝЈАВАЊЕ. Не поставяјте сполитно за преден или заден дел на возило со поставен активен аирбаг на возачкиот или патничкиот дел на возило.
SK	MOŽE NASTAT SMRT ALI JEVO VAŽNE ZNANENIA. Nedávajte autosedadku pre deti do polohy proti smeri jazdy, keď je aktívny airbag spolitného.
RU	Возможны травмы и летальный исход. Детские кресла, установленные на переднем сидении автомобиля, не имеют гарантийной безопасности, если задним occupantom установлена активная подушка безопасности.



When there is an active passenger airbag, DO NOT install rear facing child restraint systems on the front seat. Deployment of the airbag in an accident could cause fatal injuries to the child regardless of the severity of the impact. Therefore, always deactivate the passenger airbag when a rear facing child restraint system is installed on the front passenger seat. The front passenger seat must also be positioned back as far as possible in order to avoid the child restraint system from coming into contact with the dashboard. Immediately reactivate the passenger airbag as soon as the child restraint system has been removed.

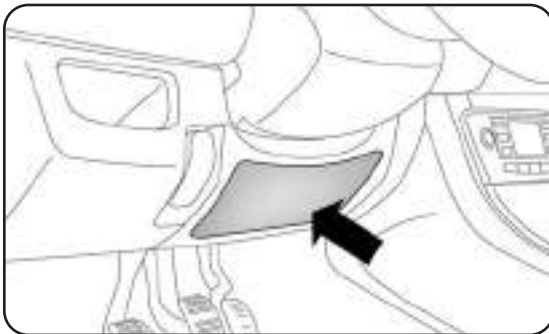

fig. 14

L0E0069m

KNEE BAG ON DRIVER'S SIDE fig. 14 (for versions/markets, where provided)

It consists of an instantly inflating cushion housed in a compartment provided for the purpose under the lower post guard at driver's knee level, designed to give further protection in the event of frontal impact.

Manual deactivation of passenger front airbag and side bag

Should it be absolutely necessary to carry a child on the front seat, the passenger front airbags and side bags can be deactivated.

The instrument panel  warning light will stay on constantly until the passenger front airbag and the Side Bag are reactivated.

IMPORTANT To deactivate the passenger's front airbag and the side bags (for versions/markets, where provided), refer to "Multifunction display" and "Reconfigurable multifunction display" paragraphs in the "Knowing your car" chapter.

SIDE BAGS (Side bag - Window bag)

SIDE BAG fig. 15

It consists of an instantly inflating bag housed in the front seat backrest. It protects the chest and the pelvis of the passengers in the event of side crashes of medium-high severity.

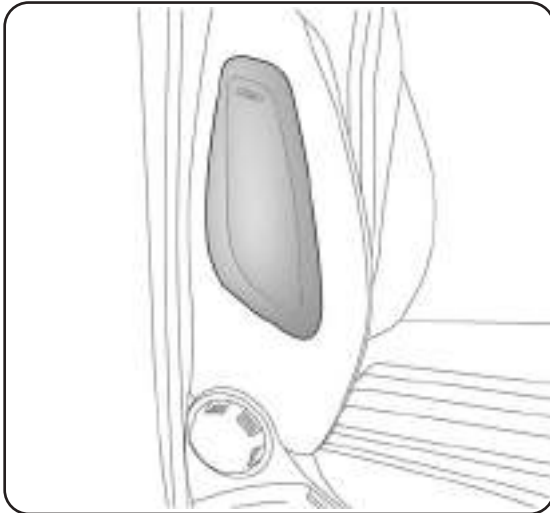

fig. 15

LOE0070m

WINDOW BAGS fig. 16

This is formed by two “curtain” window bags located behind the side roof cover and are covered by special trim. They are designed to protect the head of front and rear passengers in the event of side collisions, thanks to the wide cushion inflation surface.

IMPORTANT In the event of a side impact, the system provides best protection if the passenger sits on the seat in a correct position, thus allowing correct window bag deployment.

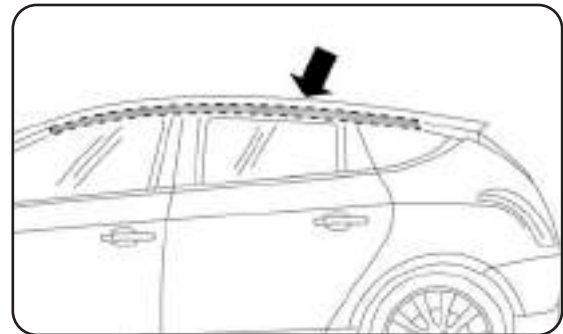

fig. 16

LOE0071m



IMPORTANT The front airbags and/or side bags may activate in the event of sharp knocks to the underbody of the vehicle (e.g. impact with steps, pavements, potholes or road bumps etc.).

IMPORTANT A small amount of dust will be released when the airbags are deployed. The dust is harmless and does not indicate the beginning of a fire. Furthermore, the surface of the deployed bag and the interior of the car may be covered with dusty residue. This dust can irritate skin and eyes. Wash with mild soap and water in the event of exposure.

IMPORTANT Pretensioners, front airbags and side bags are deployed according to different logic on the basis of the type of collision. Non-deployment of one or more of the devices does not therefore indicate a system malfunction.



Do not rest your head, arms or elbows on the door, on the windows and on the window bag area to avoid injuries during inflation. Never lean your head, arms or elbows out of the window.

IMPORTANT Should an accident occur activating any of the safety devices, take the car to a Lancia Dealership to have the activated devices replaced and the system checked.

Airbag checking, repair and replacement must only be carried out at a Lancia Dealership. If you are having the car scrapped, have the airbag system deactivated at a Lancia Dealership first. If the car changes ownership, the new owner must be informed of the method of use of airbags and the above warnings and also be given this “Owner Handbook”.

GENERAL WARNINGS



If when turning the key to MAR the  warning light does not turn on or if it stays on when travelling, there could be a failure in the safety systems; in this event airbags or pretensioners may not be deployed in the event of an impact or, in a lower number of cases, they may deploy accidentally. Before proceeding, contact a Lancia Dealership immediately to have the system checked.

Do not cover the front seat backrests with covers if side bags are fitted.



Never travel with objects on your lap, in front of your chest or with something between your lips like a pipe or pencil, etc. In the event of an impact where the airbags are deployed this could cause serious injury.



Always keep your hands in the correct position on the steering wheel whilst driving so that if the airbags are activated they can inflate properly. Do not drive with your body bent forward. Keep the backrest in straight position, resting your back correctly on it.



If someone tried to steal or damage your car, and in the event of floods, have the airbag system checked by a Lancia Dealership.



With ignition key inserted, at MAR, even if the engine is off, the airbags can activate also with the car stopped, if it is hit by another vehicle. Therefore, even if the car is stationary, when an active passenger airbag is fitted, DO NOT install rear facing child restraint systems on the front passenger seat. Deployment of the airbag following an impact could cause fatal injuries to the child. Therefore, always deactivate the passenger airbag when a rear facing child restraint system is installed on the front passenger seat. The front passenger seat must also be positioned back as far as possible in order to avoid the child restraint system from coming into contact with the dashboard. Immediately reactivate the passenger airbag as soon as the child restraint system has been removed. Also remember that, if the key is turned to STOP, none of the safety devices (airbags or pretensioners) will be deployed in the event of collision. Non-deployment in such cases does not indicate a system malfunction.



When the ignition key is turned to MAR, the \mathcal{A} warning light turns on and blinks for a few seconds to remind you that the passenger airbag will activate in the event of a collision. Then it should turn off.



Do not wash the seats with water or pressurised steam (by hand or at automatic car seat washing stations).



The front airbags deploy in the event of more severe collisions than those required for deploying the pretensioners. For impacts in the range between the two activation thresholds, pretensioner activation alone is normal.



Do not hook rigid objects to clothes hangers and support handles.



The airbag does not replace seat belts; it increases their effectiveness. Furthermore, since front airbags are not deployed in low speed collisions, side collisions, rear-end shunts or roll-overs, the passengers are only protected by the seat belts which must be fastened at all times.

page intentionally left blank



Starting the engine	184
Handbrake	187
Using the gearbox	188
Saving fuel	189
Towing trailers	191
Snow tyres	192
Snow chains	193
Car inactivity	193

STARTING THE ENGINE

The car is fitted with an electronic engine lock device: if the engine fails to start, see the “Lancia CODE system” paragraph in chapter 1.



In the first period of use, we recommend avoiding excessive stress for the car (for instance excessive accelerations, extended travel at maximum speed, sudden braking etc.).



With engine off, do not leave the key in the ignition switch on MAR to prevent draining the battery.







It is dangerous to let the engine run in enclosed spaces. The engine takes in oxygen and releases carbon dioxide, carbon monoxide and other toxic gases.



Remember that the brake servo and electrical power steering system are not operational until the engine is started, therefore a greater effort will be required to press the brake pedal or turn the steering wheel.



Proceed as follows:

- engage the handbrake;
- put the gear lever into neutral;
- turn the ignition key to MAR: the  and  warning lights on the instrument panel will turn on;
- wait for the warning lights  and  to turn off. The hotter the engine is, the quicker this will happen;
- fully depress the clutch pedal without operating the accelerator;
- turn the ignition key to AVV as soon as the  warning light goes out. Waiting too long will waste the heating work carried out by the glow plugs.

Release the key as soon as the engine starts.

IMPORTANT With cold engine, the accelerator pedal shall be completely released while turning the ignition key to AVV.

If the engine does not start at the first attempt, turn the ignition key to STOP again before repeating the procedure. If instrument panel  warning light remains lit when the ignition key is turned to MAR, turn the key to STOP and then back to MAR; if the warning light remains lit, try the other keys provided with the vehicle. Contact a Lancia Dealership if you still cannot start the engine.



The  warning light will flash for 60 seconds after starting or during prolonged cranking to indicate a fault with the glow plug pre-heating system. Use the car normally if the engine starts and go to a Lancia Dealership as soon as possible.

HOW TO WARM UP THE ENGINE AFTER IT HAS JUST STARTED

Proceed as follows:

- drive off slowly, letting the engine turn at medium speed. Do not accelerate abruptly;
- do not demand maximum performance for the first few kilometres. Wait until the engine coolant gauge starts moving.



Never bump start the engine by pushing, towing or coasting downhill. This could cause fuel to flow into the catalytic converter and damage it beyond repair.

ENGINE SWITCHING OFF

Turn the ignition key to STOP while the engine is idling.

IMPORTANT After a demanding drive, you should allow the engine to “catch its breath” before turning it off by letting it idle to allow the temperature in the engine compartment to fall.



A quick burst on the accelerator before turning off the engine serves absolutely no practical purpose; it wastes fuel and is especially damaging to turbocharged engines.



HANDBRAKE

The handbrake lever is located between the front seats. Pull the lever upwards to operate the handbrake, until the car is braked.



The car should be braked after a few clicks of the lever; if it is not, contact a Lancia Dealership to have it adjusted.

When the handbrake is on and the ignition key is at MAR, the instrument panel (C) warning light will come on.

Proceed as follows to release the handbrake:

- slightly lift the lever and press release button A - fig. 1;
- keep button A pressed and lower the lever. The (C) warning light on the instrument panel turns off.

Press the brake pedal when carrying out this operation to prevent the car from moving accidentally.

PARKING

Proceed as follows:

- stop the engine and engage the handbrake;
- engage a gear (on a slope, engage first gear if the car is facing uphill or reverse if it is facing downhill) and leave the wheels steered.

Block the wheels with a wedge or a stone if the car is parked on a steep slope.

Do not leave the ignition key on MAR to avoid draining the battery. Always remove the key when you leave the car.

Never leave children unattended in the car. Always remove the ignition key when leaving the car and take it out with you.

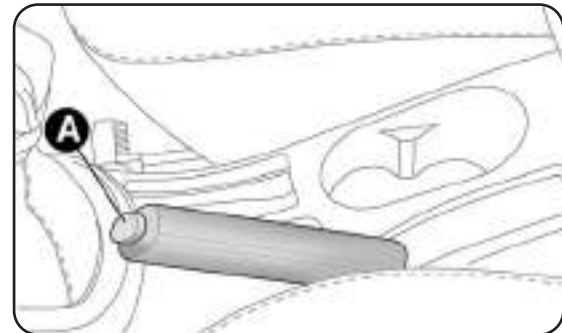

fig. 1

L0E0072m

USING THE GEARBOX

To engage the gears, press the clutch pedal fully and shift the gear lever into the required position (the gear diagram varies according to the different versions and is shown on the knob or on the plate below the lever fig. 2).

To engage 6th gear, operate the lever by pressing it towards the right in order to avoid engaging 4th gear by mistake. The same goes for changing from 6th to 5th.

IMPORTANT The car can only be put into reverse gear when it has stopped moving completely. With the engine running, wait at least 2 seconds before engaging reverse gear with the clutch pedal fully depress in order to avoid damaging or grinding the gears.

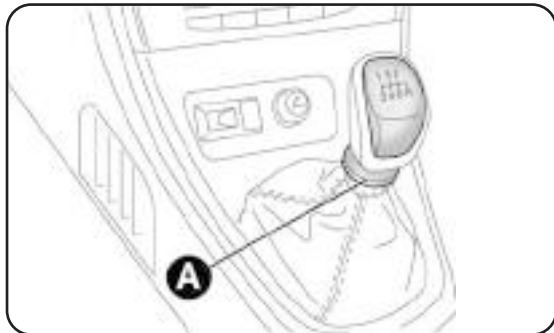

fig. 2

LOE0073m

To engage reverse gear R from neutral, raise sliding ring A under the knob and at the same time move the gear lever to the left and then forwards.

To engage reverse R from neutral, lift the sliding ring A under the knob and move the gear lever to the right and then backwards.

IMPORTANT The clutch pedal should be used only to change gear. Do not drive with your foot resting on the clutch pedal, however lightly. For versions/markets where provided, the electronic clutch pedal control could cut in, interpreting the incorrect driving style as a fault.



Press the clutch pedal fully to change gears correctly. Therefore, the floor area under the pedal unit should be clear: ensure that any mats are flat and do not interfere with the pedals.



Do not drive with your hand resting on the gear lever, because this pressure, even if light, can wear out the internal components of the gearbox over time.



SAVING FUEL

Some useful tips are given below for saving fuel and reducing harmful emissions of CO₂ and other pollutants (nitrogen oxides, unburnt hydrocarbons, Particulate Matter (PM), etc.).

GENERAL CONSIDERATIONS

Car maintenance

Have checks and adjustments carried out in accordance with the “Scheduled Servicing Plan”.

Tyres

Check the pressure of the tyres routinely at an interval of no more than 4 weeks: if the pressure is too low, consumption levels increase as resistance to rolling is higher.

Unnecessary loads

Do not travel with an overloaded luggage compartment. The weight of the car (especially when driving in town) and its ride greatly affect consumption and stability.

Accessories installed on longitudinal bars

Remove accessories like: roof racks, ski racks, luggage container, etc. from the roof if they are no longer used. These accessories lower aerodynamic penetration and adversely affect consumption levels. When transporting particularly large objects, use a trailer if possible.

Electric devices

Use electrical devices only for the amount of time needed. The heated rear window, additional headlights, windscreen/rear window wipers and heater fan need a considerable amount of energy, therefore increasing fuel consumption (by up to 25% in the urban cycle).

Climate control system

Using the climate control system leads to higher fuel consumption (on average up to +20%). If the temperature outside permits, try and use the ventilation only.

Devices for aerodynamic control

The use of non-certified devices for aerodynamic control may adversely affect air drag and consumption levels.

DRIVING STYLE

Cranking

Do not warm up the engine at low or high revs when the car is stationary: under these conditions the engine warms up much more slowly, increasing consumption and emissions. It is therefore advisable to move off immediately, slowly, avoiding high speeds: in this way the engine will warm up more quickly.

Unnecessary actions

Avoid revving up when at traffic lights or before stopping the engine. The latter action, like double-declutching, is completely unnecessary and causes increased fuel consumption and pollution.

Gear selection

As soon as the conditions of the traffic and road permit, use a higher gear. Using a low gear for faster acceleration will increase consumption.

In the same way improper use of a high gear increases consumption, emissions and engine wear.

Max. speed

Fuel consumption considerably increases as speed increases. Maintain a constant speed, avoiding unnecessary braking and acceleration, which cost in terms of both fuel consumption and emissions.

Acceleration

Accelerating violently will greatly affect consumption and emissions: acceleration should be gradual.

CONDITIONS OF USE

Cold starting

Short journeys and frequent cold starts do not allow the engine to reach optimum operating temperature. This results in a significant increase in consumption levels (from +15 to +30% on the urban cycle) and emissions.

Traffic and road conditions

Rather high fuel consumption is caused by heavy traffic, for instance when travelling in a queue with frequent use of low gears or in large towns with many traffic lights. Mountain and rough roads also have a negative effect on fuel consumption.

Stops in traffic

During prolonged stops (e.g. level crossings) the engine should be switched off.



TOWING TRAILERS

IMPORTANT

For towing caravans or trailers the car must be fitted with a certified tow hook and an adequate electrical system. Installation should be carried out by specialised personnel who will issue the required papers for travelling on roads. Install any specific and/or additional door mirrors as specified by the Highway Code.

Remember that when towing a trailer, steep hills are harder to climb, braking spaces increase and overtaking takes longer depending on the overall weight.

Engage a low gear when driving downhill, rather than constantly using the brake.

The weight the trailer exerts on the car tow hook reduces the car's loading capacity by the same amount. To make sure that the maximum towable weight is not exceeded (given in the car registration document) account should be taken of the fully laden trailer, including accessories and luggage.

Do not exceed the speed limits specific to each country you are driving in, in the case of vehicles towing trailers. In any case, the top speed must not exceed 100 km/h.



The ABS with which the vehicle may be equipped does not control the braking system of the trailer. Take specific care when travelling on slippery roads.



Never modify the braking system of the car to control the trailer brake. The trailer braking system must be fully independent from the hydraulic system of the car.

SNOW TYRES

Use snow tyres of the same size as the normal tyres provided with the car.

A Lancia Dealership will be happy to provide advice concerning the most suitable type of tyre for your requirements.

For the type of snow tyre to fit, the inflation pressures and specifications, follow the instructions in the "Wheels" paragraph in chapter "6" very carefully. The winter features of these tyres are reduced considerably when the tread depth is below 4 mm. Replace them in this case.

Due to snow tyre characteristics, under normal conditions of use or on long motorway journeys, the performance of these tyres is lower than that of standard tyres. Limit performance according to the use for which they were certified.

IMPORTANT When using snow tyres with a maximum speed index below the one that can be reached by the car (increased by 5%), place a notice in the passenger compartment, plainly in view, which states the maximum speed allowed by the snow tyres (as per EC Directive). All four tyres should be the same (brand and track) to ensure greater safety when driving and braking and better driveability.

Remember that it is inadvisable to change the rotation direction of tyres.



The maximum speed for snow tyres marked "Q" is 160 km/h; in any case, make sure you comply with the regulations of the highway code.



SNOW CHAINS

The use of snow chains should be in compliance with local regulations.

The snow chains may be applied only onto the front wheel (drive wheels).

Check the tension of the snow chains after the first few metres have been driven.

IMPORTANT Snow chains cannot be fitted to the space-saver wheel. So, if a front (drive) wheel is punctured and chains are needed, a rear wheel should be fitted to the front of the car and the space-saver wheel should be fitted to the rear. In this way, with two normal drive wheels at the front, snow chains can be fitted.



Keep your speed down when snow chains are fitted. Do not exceed 50 km/h. Avoid potholes, steps and pavements and also avoid driving long distances on roads not covered with snow in order to prevent damaging the car and the roadbed.

CAR INACTIVITY

If the car is to be left inactive for longer than a month, the following precautions should be followed:

- park the car in a covered, dry and, if possible, well-ventilated place;
- engage a gear;
- check that the handbrake is not engaged;
- disconnect the negative battery terminal;
- clean and protect the painted parts of the vehicle with protective wax;
- clean and protect the shiny metal parts using special compounds commercially available;
- sprinkle talcum powder on the rubber windscreen and rear window wiper blades and lift them off the glass;
- open the windows slightly;
- cover the car with a fabric or perforated plastic sheet. Do not use sheets of non-perforated plastic as they do not allow moisture on the car body to evaporate;
- inflate tyres to a pressure of +0.5 bar above the normal specified pressure and check regularly;
- do not drain the engine cooling system.

blank page



In an emergency we recommend that you call the freephone number found in the Warranty Booklet. It is also possible to go to the www.lancia.com website to find the closest Lancia Dealership.

Starting the engine	196
Fix&Go Automatic kit	198
Replacing a wheel	203
Replacing a bulb	211
Replacing an exterior bulb	214
Replacing an interior bulb	219
Replacing fuses	223
Battery recharging	230
Lifting the car	231
Towing the car	231

STARTING THE ENGINE

Go to a Lancia Dealership immediately if instrument panel  warning light remains on constantly.

JUMP STARTING **fig. 1**

If the battery is flat, the engine may be started using an auxiliary battery with the same capacity or a little higher than the flat one.



Strictly avoid using a rapid battery charger for jump starting: this could damage the electronic systems and the engine fuel supply and ignition control units.



This starting procedure must be carried out by expert personnel as incorrect manoeuvres can cause electrical discharges of considerable intensity. Furthermore, battery fluid is poisonous and corrosive: avoid contact with skin and eyes. Keep naked flames away from the battery. No smoking. Do not cause sparks.

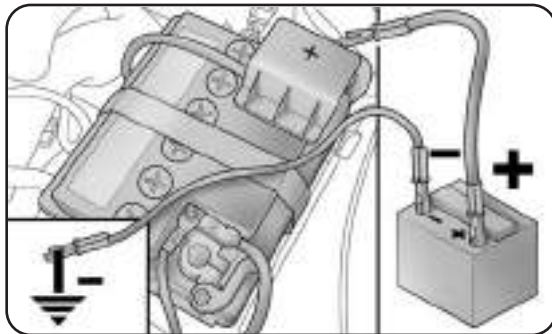

fig. 1

LOE0074m



Proceed as follows to start the car:

- connect the positive terminals (+ sign close to the terminal) of both batteries using a lead;
- with a second lead, connect the negative terminal – of the auxiliary battery to an earthing point ↓ on the engine or the gearbox of the car to be started;
- start the engine;
- when the engine has been started, follow the sequence above in reverse order to remove the leads.

If after a few attempts the engine does not start, do not persist but contact a Lancia Dealership.

IMPORTANT Do not directly connect the negative terminals of the two batteries: any sparks may ignite the explosive gas which could come out of the battery. If the auxiliary battery is installed on another car, prevent any contact between metal parts of the two cars.

BUMP STARTING

Never bump start the engine by pushing, towing or coasting downhill.

This could cause fuel to flow into the catalytic converter and damage it beyond repair.

IMPORTANT Remember that the brake servo and electrical power steering system (where provided) are not operational until the engine is started, a greater effort will therefore be required to press the brake pedal or turn the steering wheel.

FIX & GO AUTOMATIC KIT

The Fix & Go Automatic quick tyre repair kit is located in the luggage compartment.

The kit fig. 2 includes:

- a bottle A containing sealant and fitted with:
 - filler pipe B;
 - an adhesive label C with the message “max. 80 km/h” to be applied in a position clearly visible by the driver (on the dashboard) after repairing the tyre;
- informative leaflet (see fig. 3), used to ensure the correct use of the quick tyre repair kit and then given to the personnel who will be handling the treated tyre;

- a compressor D - fig. 2 including a pressure gauge and connectors, found in the compartment;
- a pair of protective gloves located in the side compartment of the compressor;
- adapters for inflating different elements.

The quick tyre repair kit also contains a screwdriver and a tow hook.

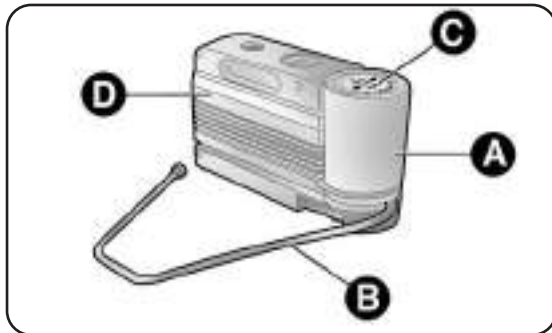

fig. 2

LOE0075m



fig. 3

LOE0076m



Give the booklet to the personnel who will be handling the tyre treated with the repair kit.



Punctures caused by foreign bodies can be repaired if the damage does not exceed 4 mm on the tread and on the shoulder of the tyre.



Punctures on the sides of the tyre cannot be repaired. Do not use the quick tyre repair kit if the tyre is damaged as the vehicle has run on a flat tyre.



If the wheel rim is damaged (the channel is so deformed as to cause air leakage) it cannot be repaired. Do not remove foreign bodies (screws or nails) from the tyre.

IMPORTANT INFORMATION

The sealant of the quick tyre repair kit is effective with external temperatures between -20°C and $+50^{\circ}\text{C}$. The sealant has an expiry date.



Never operate the compressor for longer than 20 consecutive minutes. Risk of overheating. The quick tyre repair kit is not suitable for a definitive repair. Tyres may only be repaired temporarily.



The bottle contains ethylene glycol. It contains latex that might cause allergic reactions. It is harmful if swallowed. It is irritant for the eyes. It may cause sensitisation if inhaled or on contact. Avoid contact with eyes, skin and clothes. In the event of contact, wash immediately with plenty of water. Do not induce vomiting if swallowed. Rinse your mouth and drink plenty of water. Call a doctor immediately. Keep out of the reach of children. The product must not be used by asthmatics. Do not breathe in the vapours during insertion and suction. Call a doctor immediately if allergic reactions are noted. Store the bottle in the specific compartment, away from sources of heat. The sealant has an expiry date.



Replace the bottle containing out-of-date sealant. Dispose of the bottle and the sealant properly. Dispose of the components in compliance with national and local regulations.

INFLATION PROCEDURE



Put on the protective gloves provided with the quick tyre repair kit.

- Engage the handbrake. Unscrew the tyre valve cap, take out the filler hose A - fig. 4 and tighten the ring nut B on the tyre valve;

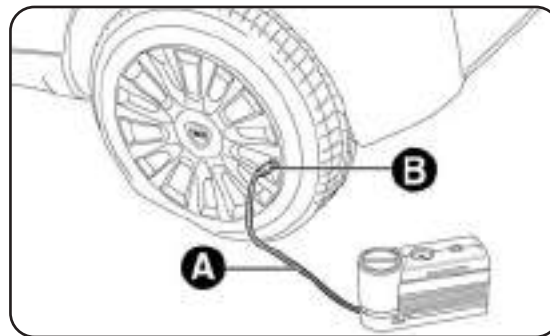

fig. 4



- make sure that switch C - fig. 5 for the compressor is in position 0 (off), start the engine, insert pin E - fig. 5a into the power socket and switch on the compressor by placing switch C - fig. 5 in position I (on);
- inflate the tyre to the pressure specified in the “Inflation pressure” paragraph, in chapter “6”. For a more accurate reading, check pressure value on pressure gauge D - fig. 5 with the compressor off;
- if after 5 minutes you cannot reach at least 1.5 bar, unplug the compressor from the valve and the power socket, then move the car forward about 10 metres in order to distribute the sealant inside the tyre evenly, then repeat the inflation operation;
- if after this operation it is still not possible to reach at least 1.8 bar after 5 minutes, do not start driving since the tyre is excessively damaged and the quick tyre repair kit cannot guarantee suitable sealing. Contact a Lancia Dealership;
- if the tyre reaches the pressure specified in the “Inflation pressure” paragraph in chapter “6”, start driving immediately;



Apply the adhesive label in a position clearly visible by the driver as a reminder that the tyre has been treated with the quick repair kit. Drive carefully, particularly on bends. Do not exceed 80 km/h. Do not accelerate or brake suddenly.

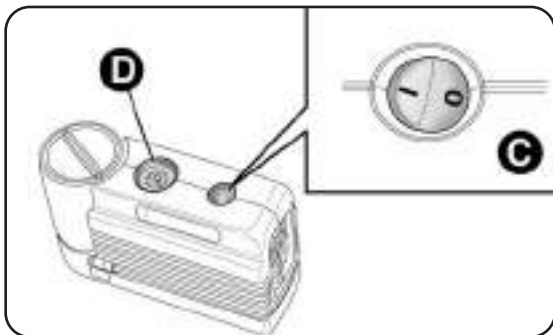

fig. 5

L0E0078m

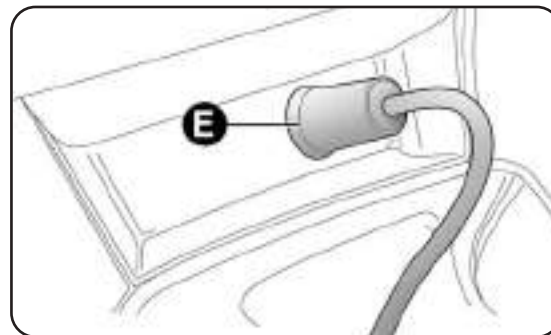

fig. 5a

L0E0288m

- after driving for about 10 minutes stop and check the tyre pressure again; pull up the handbrake



If the pressure falls below 1.8 bar, do not drive any further: the Fix & Go automatic quick tyre repair kit cannot guarantee suitable sealing because the tyre is too damaged. Contact a Lancia Dealership.

- if you get a pressure reading of at least 1.8 bar, restore the correct pressure (with engine running and handbrake on) and resume driving;
- drive with the utmost care to the nearest Lancia Dealership.



Inform the Dealership that the tyre has been repaired using the quick tyre repair kit. Give the booklet to the personnel charged with handling the treated tyre.

CHECKING AND RESTORING TYRE PRESSURE

The compressor can also be used solely for restoring pressure. Release the quick coupling and connect directly to the tyre valve fig. 6; in this way, the bottle will not be connected to the compressor and no sealant will be injected.

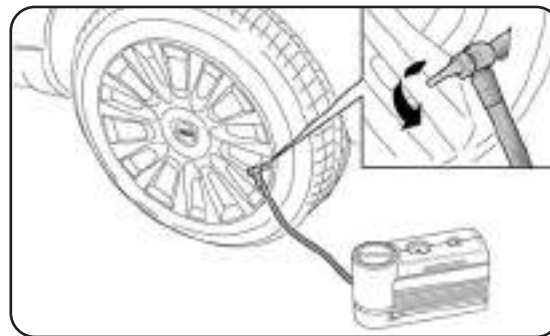

fig. 6



BOTTLE REPLACEMENT PROCEDURE

To replace the bottle, proceed as follows:

- disconnect connection A - fig. 7;
- turn the bottle to be replaced anticlockwise and raise it;
- fit the new bottle and turn it clockwise;
- connect connection A to the bottle and fit the transparent tube B in the dedicated space.

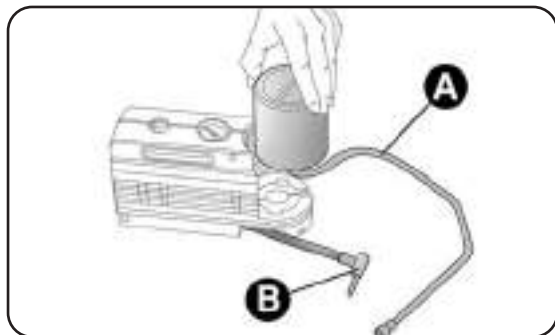

fig. 7

L0E0289m

REPLACING A WHEEL

GENERAL INSTRUCTIONS

The car may be originally fitted with a space-saver wheel (for versions/markets, where provided).

Wheel replacement and correct use of the jack and space-saver wheel call for some precautions as listed below.



The space-saver wheel provided (for versions/markets, where provided) is specific for the car; do not use it on other models, or use the space-saver wheel of other models on your car. The space-saver wheel must only be used in the event of emergency. Never use it for more than strictly necessary and never exceed 80 km/h. On the space-saver wheel there is an orange label, summarising the main warnings regarding space-saver wheel usage restrictions.



*Never remove or cover the label. Never apply a hub cap on a space-saver wheel. The label bears the following instructions in four languages: **WARNING! FOR TEMPORARY USE ONLY! 80 KM/H MAX.! REPLACE WITH STANDARD WHEEL AS SOON AS POSSIBLE. DO NOT COVER THIS LABEL.***

If you change the type of wheel (alloy rims instead of steel rims) you will have to change the entire set of fastening bolts with another set of suitably sized bolts.



Alert other drivers that the car is stationary in compliance with local regulations: hazard warning lights, warning triangle, etc. Any passengers on board should leave the car, especially if it is heavily laden. Passengers should stay away from on-coming traffic while the wheel is being changed. If parked on a slope or rough surface, chock the wheels with wedges or other suitable devices.



The jack can only be used for changing wheels on the car with which it is provided or on cars of the same model. Never use the jack for other purposes, such as lifting other car models. Never use it for repair operations under the car. Incorrect positioning of the jack may cause the car to fall. Do not use the jack for loads higher than those shown on the label. Snow chains cannot be fitted to the space-saver wheel. Therefore, if a front (drive) wheel is punctured and chains are required, a rear wheel should be fitted at the front of the car and the space-saver wheel should be fitted to the rear. This way, with two normal front driving wheels, you can install the snow chains on them, thus resolving the emergency.



If the hub cap is not installed properly, it may detach when the vehicle is running. Never tamper with the inflation valve. Never introduce tools of any kind between rim and tyre. Regularly check tyre and space-saver wheel pressure, complying with the data in the chapter “6”.



The driving characteristics of the car may change when a space-saver wheel is fitted. Avoid violent acceleration and braking, abrupt steering and fast cornering. The total life of a space-saver wheel is approximately 3,000 km, after which it must be replaced by another wheel of the same type. Never install a standard tyre on a rim designed for use as a space-saver wheel. Have the wheel repaired and refitted as soon as possible. Using two or more space-saver wheels at the same time is forbidden. Do not apply grease to the bolt threads before assembly: they might spontaneously unscrew.

Tool box (versions with HI-FI Bose)

There is a tool box located in the luggage compartment for versions with HI-FI Bose.

This box contains:

- screwdriver;
- tow hook;
- wheel bolt spanner;
- wheel bolt access spanner;
- alloy rims centring device;
- jack.

REMOVING THE SUBWOOFER

(versions with HI-FI Bose)

(for versions/markets, where provided)

IMPORTANT The following procedure only applies to cars equipped with HI-FI Bose systems with subwoofer (for versions/markets, where provided).

SUBWOOFER AND SPACE-SAVER WHEEL

Proceed as follows to remove the subwoofer:

- open the luggage compartment, pull tab A - fig. 10 and lift up the mat;
- undo locking device A - fig. 8 and lift up the subwoofer. Then remove connection cable B from velcro attachment C;

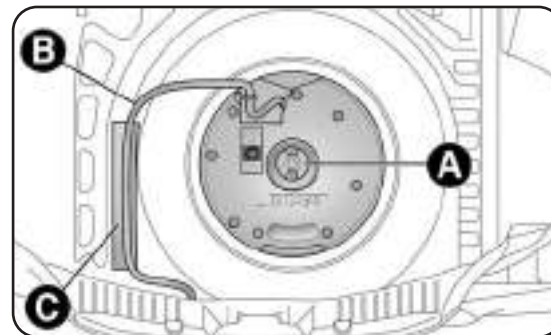

fig. 8

LD E0176m

- rest the subwoofer to one side in the luggage compartment, remove the container and take out the space-saver wheel;
- change the wheel as described in this chapter.

At the end of the operation:

- reposition the container and place the subwoofer on top of it, taking care to position it according to the instructions on the container (fig. 9) so that the arrow on the spacer is pointing in the direction of travel.
- rest cable B - fig. 8 on velcro attachment C to avoid pinching it. Then tighten locking device A - fig. 8. Lower the luggage compartment mat.

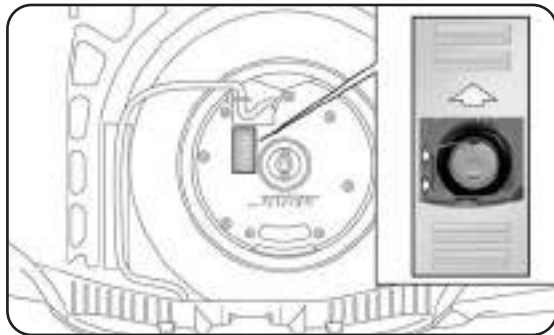

fig. 9

L0E0177m

TAKING OUT THE SPACE-SAVER WHEEL

Please note that:

- the jack weight is 1.76 kg;
- the jack requires no adjustment;
- the jack cannot be repaired; if it breaks, it must be replaced with a new one of the same type;
- no tool other than its cranking device may be fitted on the jack.

To change a wheel, proceed as follows:

- stop the car where it is not a danger to other road users and you can replace the wheel safely. The ground should be flat if possible, and sufficiently firm;
- turn the engine off and engage the handbrake;
- engage first gear or reverse;
- lift up the luggage compartment mat using handle A - fig. 10 (in the presence of a double load compartment, first lift the upper cover and then the luggage compartment mat).
- unscrew the locking device B - fig. 10;
- take out the tool box C and place it next to the wheel to be changed;
- take out the space-saver wheel D - fig. 10;
- use the provided screwdriver to remove the hub cap, levering the dedicated opening on the outer edge;

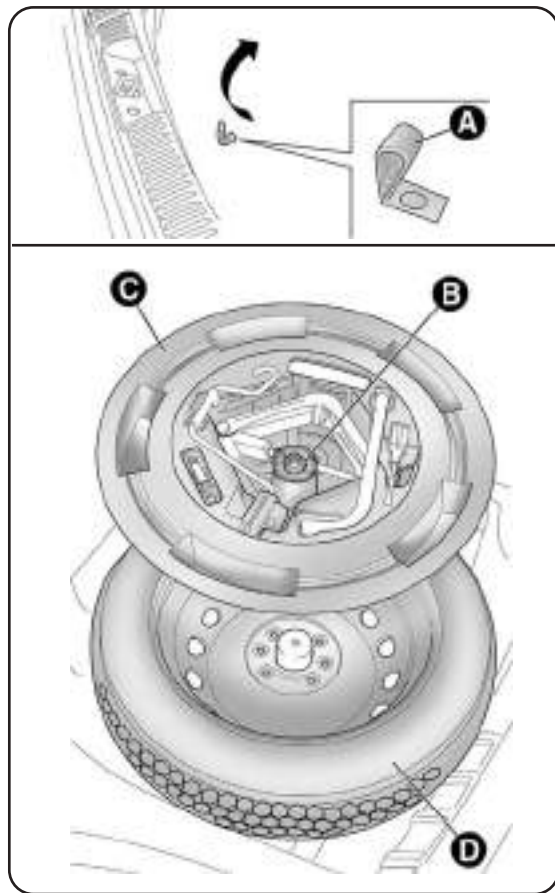

fig. 10

L0E0081m

- in the presence of a double load compartment, lift the double compartment mat and attach it to the luggage compartment mat as shown in fig. 10.
- for cars fitted with alloy rims, remove the press-fitted hub cap using the screwdriver provided;
- loosen the fixing bolts for the wheel to be changed by about one turn using the spanner provided E - fig. 11;
- turn the cranking device to partially open it;
- position the jack near the wheel to be replaced at the reference point ▼ on the side member;
- make sure that the splines F - fig. 12 on the jack are firmly fitted to tab G on the side member;

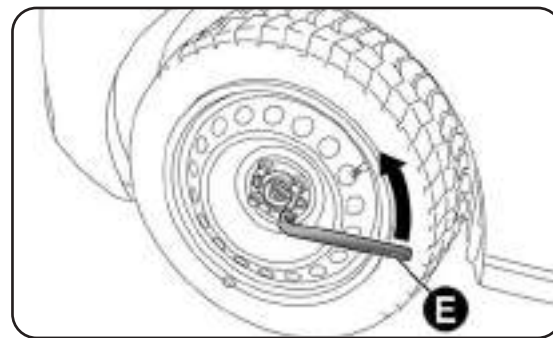

fig. 11

L0E0082m

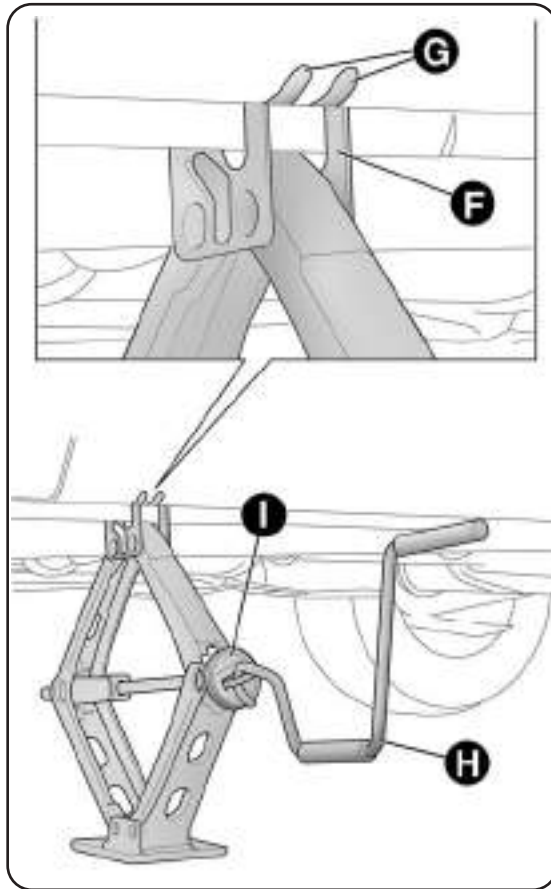

fig. 12

LOE003m

- warn anybody nearby that the car is about to be lifted. They must stay clear and not touch the car until it is back on the ground;
- fit the handle H - fig. 12 into device I of the jack and lift the car until the wheel is several centimetres off the ground. When turning the jack handle make sure that it can turn freely without scraping your hand against the ground. The moving components of the jack (screws and joints) can also cause injuries: avoid touching them. If you become soiled with the lubricating grease, clean it off thoroughly;
- make sure the contact surfaces on the space-saver wheel are clean so that the retaining bolts will not come loose;
- fit the space-saver wheel, aligning pins T - fig. 13 with one of the holes A on the wheel;
- tighten the 4 fixing bolts;
- turn the jack handle to lower the car and remove the jack;
- fully tighten the bolts, passing alternately from one bolt to the opposite one, following the order illustrated in fig. 13.

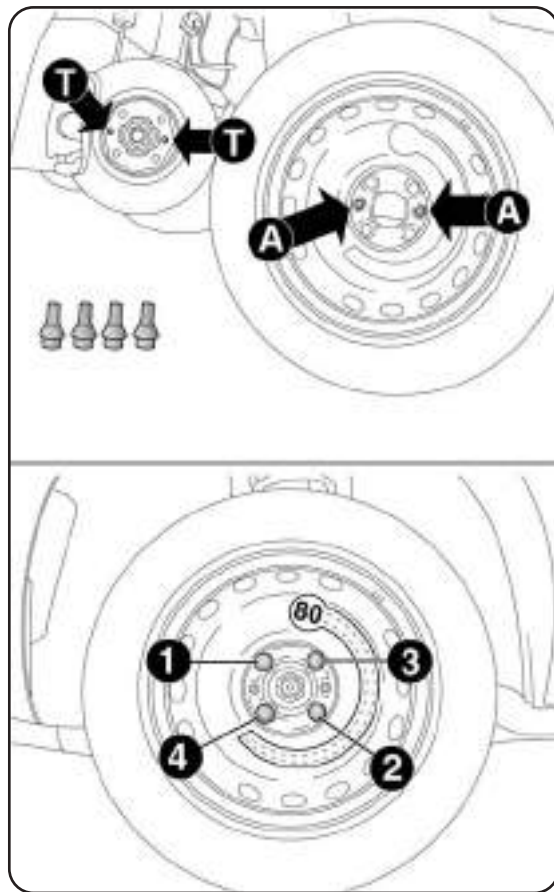

fig. 13

L0E0113m

REFITTING THE STANDARD WHEEL

Following the procedure described previously, raise the car and remove the space-saver wheel.

Versions with steel rims

Proceed as follows:

- make sure the contact surfaces between standard wheel and hub are clean so that the fastening bolts will not come loose;
- fit the standard wheel inserting the 4 bolts into the holes;
- using the spanner provided, tighten the fixing bolts;
- press-fit the hub cap, aligning the special splining (on the cap) with the inflation valve;
- lower the car and remove the jack;
- using the spanner provided, fully tighten the bolts in the sequence shown previously.

Versions with alloy rims

- Place the wheel onto the hub and tighten the bolts using the spanner provided;
- lower the car and remove the jack;
- using the spanner provided, fully tighten the bolts in the sequence shown in fig. 8;
- refit the press-fitted hub cap, making sure that the reference hole on the wheel is aligned with the reference pin on the cap.

IMPORTANT If it is not fitted properly, the hub cap may detach when the vehicle is running.

At the end of the operation

- Stow the space-saver wheel D - fig. 10 in the space provided in the luggage compartment;
- fit the partially open jack in its box forcing it lightly to prevent it from vibrating when travelling;
- put the tools back into place in the box;
- stow the container, complete with tools, in the space-saver wheel and tighten the locking device B - fig. 10;
- reposition the luggage compartment mat correctly.

IMPORTANT Do not use air chambers tubes with tubeless tyres. Check the inflation pressure of the tyres and the space-saver wheel periodically.



Various fixing bolts and space-saver wheels, specific and differing in structural characteristics, are used depending on the wheel rim type (alloy or steel). Fixing bolts for alloy rims can be identified by the presence of a permanent washer and a hollow side on the bolt head.

Therefore, you will need to contact a Lancia Dealership to get the correct type of fixing bolts and space-saver wheel if you change the type of wheels fitted (alloy rims instead of steel rims, or vice versa). Keep the bolts fitted as standard in case of re-use of the wheels originally mounted on the car.



REPLACING A BULB

GENERAL INSTRUCTIONS

- Before changing a bulb, check the contacts for oxidation;
- burnt-out bulbs must be replaced by others of the same type and power;
- always check the direction of the beam after changing a headlight bulb, for safety reasons;
- when a light is not working, check that the corresponding fuse is intact before changing the bulb. For the location of fuses, refer to the “Replacing fuses” paragraph in this chapter.



Modifications or repairs to the electric system that are not carried out properly or do not take the system technical specifications into account can cause malfunctions leading to the risk of fire.



Halogen bulbs contain gas under pressure, if they break glass fragments may be thrown around.



When handling halogen bulbs just touch the metal part. If the transparent bulb is touched with the fingers, its lighting intensity is reduced and life of the bulb may be compromised. In the event of accidental contact, wipe the bulb with a cloth moistened with alcohol and leave it to dry.



Where possible, it is advisable to have bulbs changed at a Lancia Dealership. Proper operation and direction of the external lights are essential for driving in safety and comply with law.

IMPORTANT The headlight inner surface might be slightly misted: this does not indicate a fault, it is a natural phenomenon due to low temperature and the air humidity level. Misting will disappear rapidly when the headlights are turned on. The presence of drops inside the headlights indicates infiltration of water. Contact a Lancia Dealership.

IMPORTANT When the weather is cold or damp or after heavy rain or after washing, the surface of headlights or rear lights may steam up and/or form drops of condensation on the inside. This is a natural phenomenon due to the difference in temperature and humidity between the inside and the outside of the glass which does not indicate a fault and does not compromise the normal operation of lighting devices. The mist disappears quickly when the lights are turned on, starting from the centre of the diffuser, extending progressively towards the edges.

TYPES OF BULBS fig. 14

Various types of bulbs are fitted to your car:

- A. Glass bulbs: they are press-fitted. Pull to remove them.
- B. Bayonet type bulbs: to remove this type of bulb from its holder press the bulb, turn it anticlockwise and remove it.
- C. Tubular bulbs: to remove, release them from their contacts.
- D-E. Halogen bulbs: to remove the bulb, release the clip holding the bulb in place.

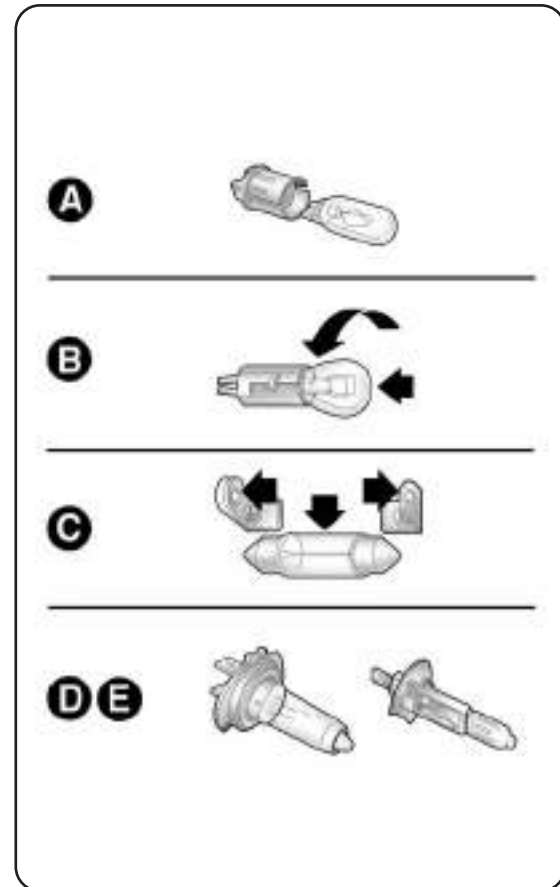

fig. 14



Bulbs	Type	Power	Figure ref.
Front side lights/Daytime running lights	LED	–	–
Rear side lights	LED	–	–
Dipped beam headlights	D1S(*) / H7	55 W	D
Main beam headlights	H1(*) / H7	55 W	D
Front direction indicator	PY 24W	24 W	B
Rear direction indicator	LED	–	–
Side direction indicator	WY5W	5 W	A
Brake light	LED	–	–
Third brake light	LED	–	–
Number plate light	W5W	5 W	C
Fog lights	H11	55 W	E
Rear fog light	W16W	16 W	B
Reverse light	W16W	16 W	B
Front roof light (white LEDs)	5L/5K	–	–
Rear roof light	12V 5W	5 W	C
Glove compartment/luggage compartment light	12V 5W	5 W	C
Puddle light	W5W	5 W	A

(*) Xenon gas discharge bulb

REPLACING AN EXTERIOR BULB

FRONT LIGHT CLUSTERS fig. 15

These contain the bulbs for the dipped beam headlights, main beam headlights and direction indicators. The bulbs are arranged as follows:

- A. Main beam headlights;
- B. Dipped beam headlights;
- C. Direction indicators.

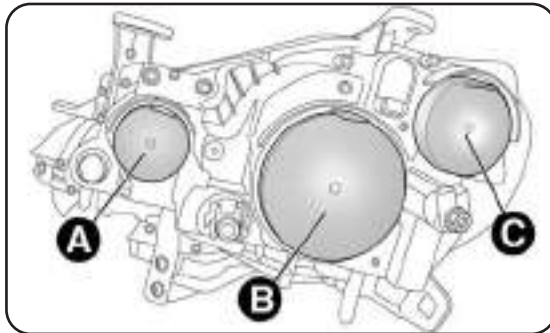

fig. 15

L0E0154m

DIPPED BEAM HEADLIGHTS

With incandescent bulbs

To change the bulb, proceed as follows:

- remove the protective cover B - fig. 15;
- release the bulb holder clip A - fig. 16;
- disconnect the electrical connector B;
- remove the bulb C and replace it;
- fit the new bulb, ensuring that the outline of the metal part coincides with the splining on the curve of the headlight. Then reconnect the electrical connector B and reattach the bulb holder clip A;
- refit the protective cover B - fig. 15.

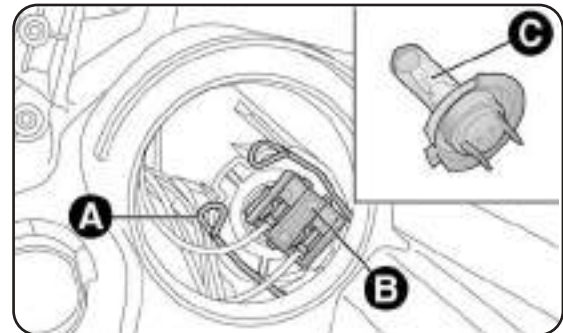

fig. 16

L0E0155m



With gas discharge bulbs (Xenon)
(for versions/markets, where provided)



Due to the high power supply voltage, gas discharge bulbs (Xenon) should only be replaced by specialised personnel: danger of death! Contact a Lancia Dealership.

With gas discharge bulbs (Xenon)
(for versions/markets, where provided)



Due to the high power supply voltage, gas discharge bulbs (Xenon) should only be replaced by specialised personnel: danger of death! Contact a Lancia Dealership.

MAIN BEAM HEADLIGHTS

With incandescent bulbs

To change the bulb, proceed as follows:

- remove the protective cover A - fig. 15;
- release the bulb holder clip A - fig. 17;
- disconnect the electrical connector B;
- remove the bulb C and replace it;
- fit the new bulb, ensuring that the outline of the metal part coincides with the splining on the curve of the headlight. Then reconnect the electrical connector B and reattach the bulb holder clip A;
- refit the protective cover A - fig. 15.

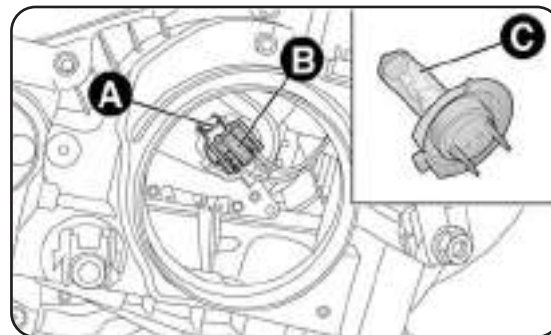

fig. 17

L0E0156m

SIDE LIGHTS/DAYTIME RUNNING LIGHTS

The side lights/daytime running lights are LED-type.
Contact a Lancia Dealership to have these lights replaced.

DIRECTION INDICATORS

Front

To replace the bulb, proceed as follows:

- remove the protective cover C - fig. 15;
- press down near the bulb holder locking tabs (shown in fig. 18 by the arrows) and simultaneously pull the unit;
- remove the bulb A and replace it;
- refit the protective cover C.

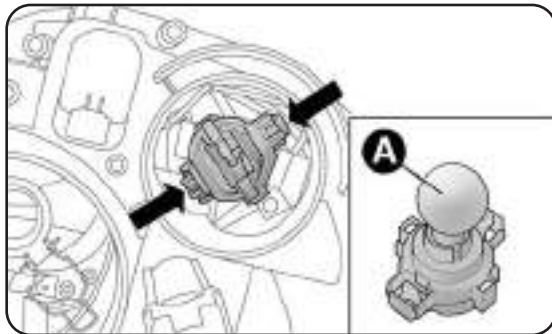

fig. 18

LOE0157m

Side

To replace the bulb, proceed as follows:

- work on the lens cover A - fig. 19 to compress internal clip B, then pull the unit outwards;
- turn the bulb holder C anticlockwise, extract the press-fitted bulb D and replace it;
- refit the bulb holder C in the lens cover and turn it clockwise;
- refit the unit making sure that the internal clip B clicks into place.

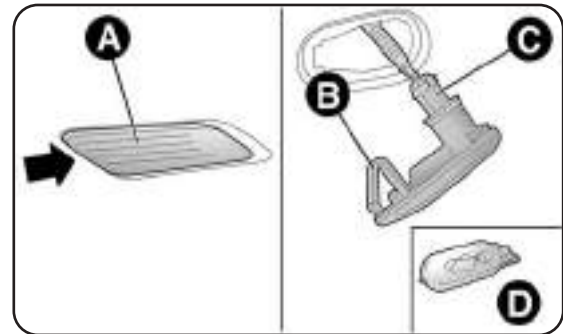

fig. 19

LOE0158m



FOG LIGHTS fig. 20

(for versions/markets, where provided)

To replace the front fog light bulbs contact a Lancia Dealership.

REAR LIGHT CLUSTERS

Contact a Lancia Dealership to replace the LED lights in the rear light clusters.

REVERSING LIGHT fig. 21

Go to a Lancia Dealership to replace the bulb.

REAR FOG LIGHT fig. 22

Go to a Lancia Dealership to replace the bulb.

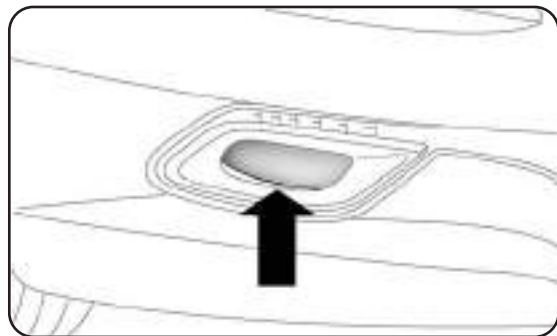

fig. 20

LOE0159m

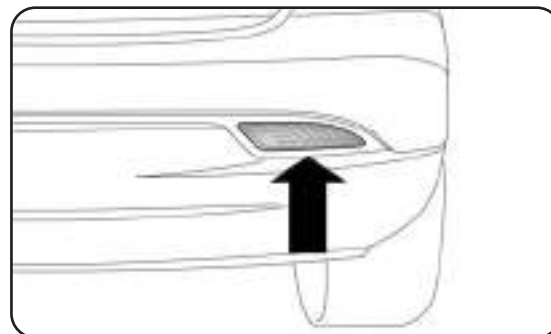

fig. 21

LOE0160m

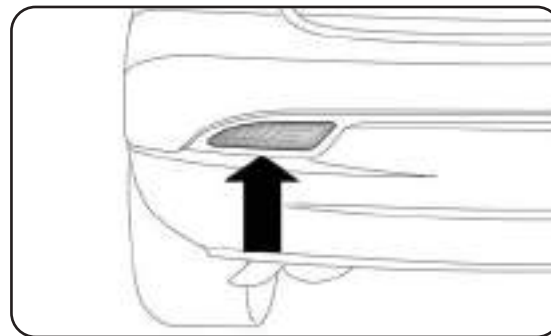

fig. 22

LOE0161m

THIRD BRAKE LIGHT **fig. 23**

Contact a Lancia Dealership to replace the third brake LED lights.

NUMBER PLATE LIGHTS

To replace the bulb proceed as follows:

- remove the lens units A - fig. 24 by acting on the points shown by the arrows;
- remove the bulb B and replace it.

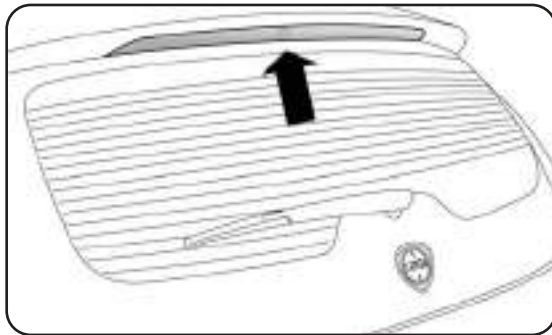

fig. 23

LOE0162m

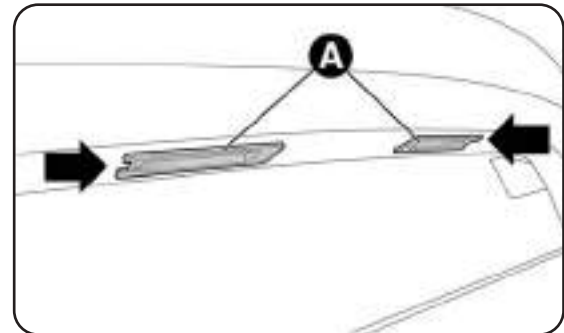

fig. 24

LOE0163m

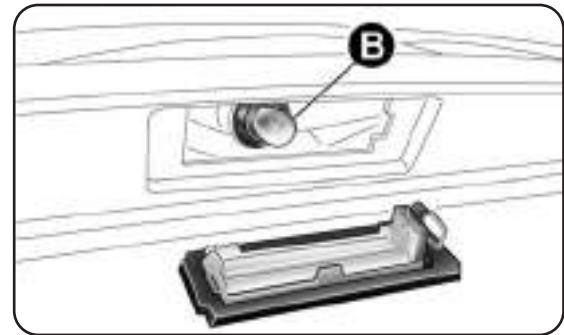

fig. 25

LOE0282m



REPLACING AN INTERIOR BULB

For the type of bulb and power rating, see the “Bulb types” paragraph.

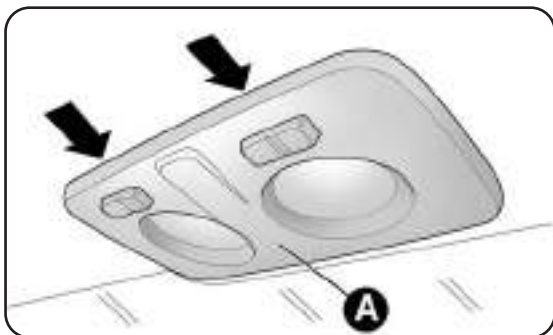

fig. 26

L0E0165m

FRONT ROOF LIGHT

Proceed as follows to replace the bulbs:

- remove the roof light A - fig. 26 by acting on the points shown by the arrows;
- open the protective flap B - fig. 27;
- replace the bulbs C releasing them from the side contacts and making sure that the new bulbs are correctly secured between the contacts;
- close flap B - fig. 27 and fasten the roof light A - fig. 26 in its housing, making sure it is locked correctly.

IMPORTANT In some versions, the roof light in fig. 26 is at the back (electric sun roof version). To replace the relevant bulbs, refer to the procedure described in paragraph “Rear roof light” in this chapter.

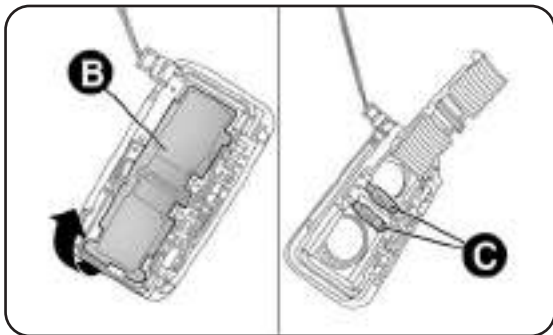

fig. 27

L0E0166m

REAR ROOF LIGHT

Versions without sun roof

Proceed as follows to replace the bulbs:

- work at the point shown by the arrow and remove roof light A - fig. 28;
- replace bulb B - fig. 29 releasing it from the side contacts and making sure the new bulb is correctly fastened between the contacts.

Versions with sun roof

To replace the bulb, proceed as follows:

- work at the point shown by the arrow and remove roof light A - fig. 30;

- replace bulb B - fig. 29 releasing it from the side contacts and making sure the new bulb is correctly fastened between the contacts.



fig. 28

L0E0167m

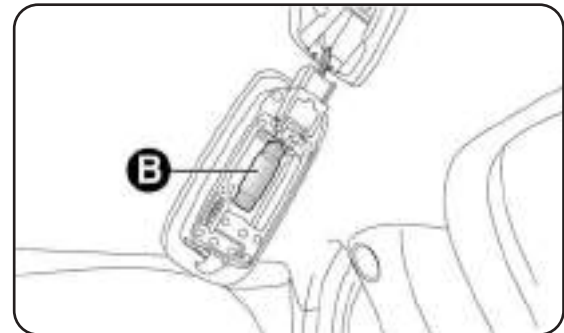

fig. 29

L0E0168m

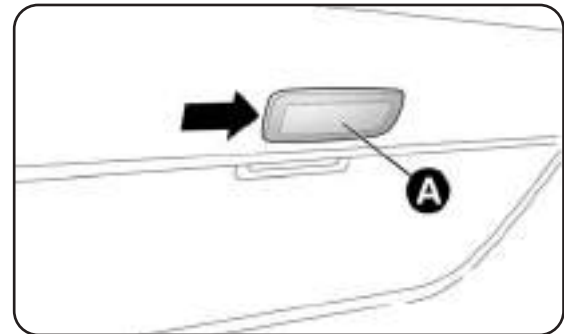

fig. 30

L0E0169m



LUGGAGE COMPARTMENT LIGHT

To replace the bulb, proceed as follows:

- open the luggage compartment;
- remove the light A - fig. 32 applying leverage at the point shown by the arrow;
- open protection B - fig. 33 and replace the press-fitted bulb;
- close protection B onto the lens cover;
- refit the light A by inserting it in its correct position firstly on one side and then on the other until it clicks into place.

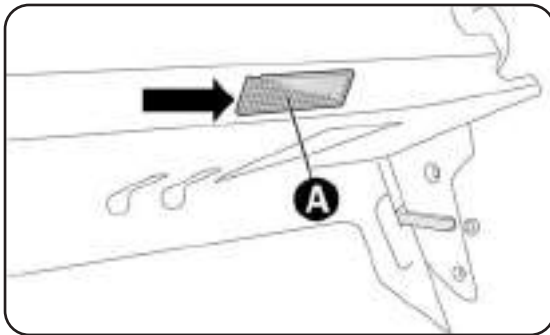

fig. 32

LOE0171m

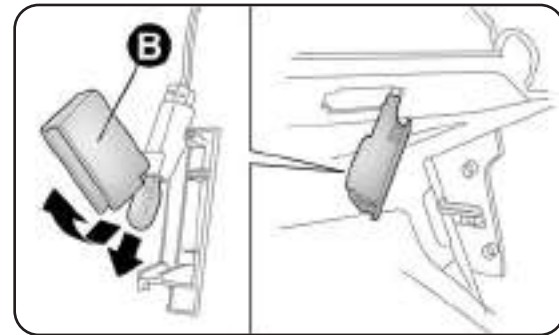

fig. 33

LOE0172m

GLOVE COMPARTMENT LIGHT

To replace the bulb, proceed as follows:

- open the glove compartment, and remove the light A - fig. 34;
- replace bulb B releasing it from the side contacts and making sure the new bulb is correctly fastened between the contacts.

COURTESY MIRROR LIGHT

(for versions/markets, where provided)

To replace the bulb, proceed as follows:

- open the cover A - fig. 35 on the mirror;
- applying leverage at the points shown by the arrows, remove light B;

- replace bulb C - fig. 36 releasing it from the side contacts and making sure the new bulb is correctly fastened between the contacts.

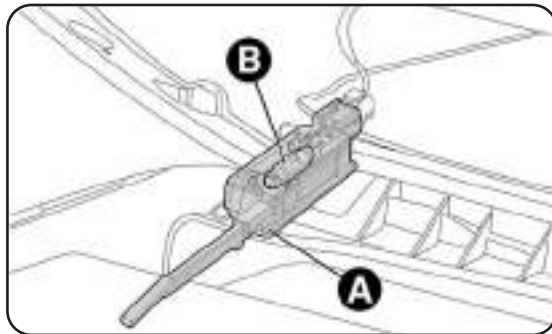

fig. 34

L0E0173m

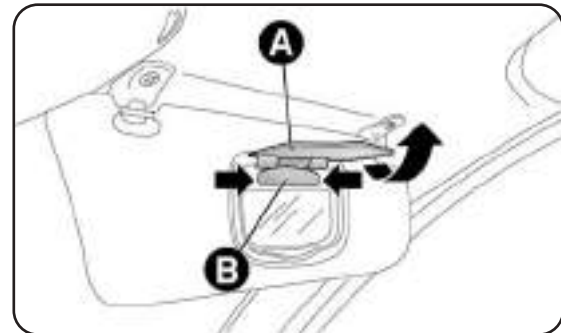

fig. 35

L0E0174m

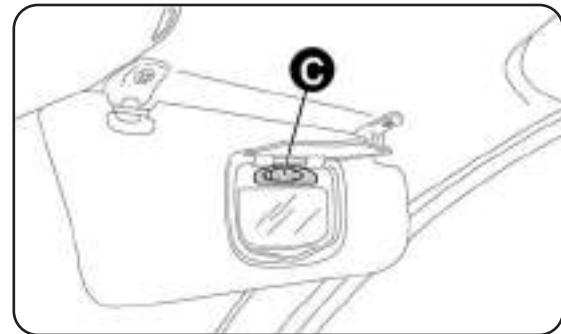

fig. 36

L0E0175m



REPLACING FUSES

GENERAL INFORMATION

Fuses protect the electric system: they blow in the event of a failure or improper action on the system. Check the condition of the corresponding fuse when a device does not work: the filament A - fig. 37 must be intact. If it is not, replace the blown fuse with another having the same amperage (same colour).

B intact fuse

C fuse with damaged filament.

To replace a fuse, use the pliers D - fig. 37 attached to the dashboard fuse box.

Refer to the tables on the following pages to identify the protection fuse.

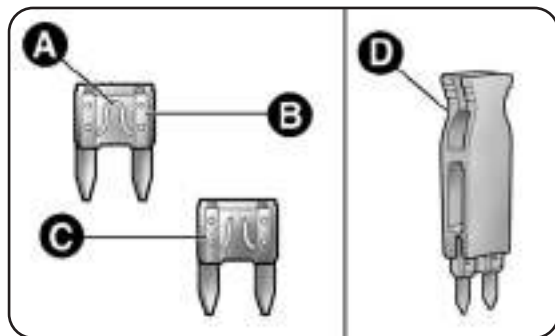

fig. 37

L0E0085m



If the fuse blows again contact a Lancia Dealership.



Never replace a blown fuse with metal wires or other materials.



Never replace a fuse with another with a higher amp rating; FIRE RISK.



If a general protection fuse (MEGA-FUSE, MIDI-FUSE, MAXI-FUSE) blows, contact a Lancia Dealership.



Before changing a fuse, check that the ignition key has been removed and that all the other electric devices have been turned off/disabled.



If a general protection fuse for safety systems (airbag system, braking system), power unit systems (engine system, gearbox system) active suspension system (for versions/markets, where provided) or steering system blows, contact a Lancia Dealership.

FUSE LOCATION

Dashboard fuse box

To access the dashboard fuse box, loosen the three screws A - fig. 38 and remove flap B.

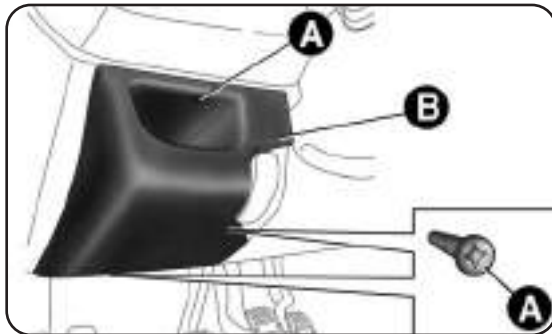

fig. 38

L0E0208m

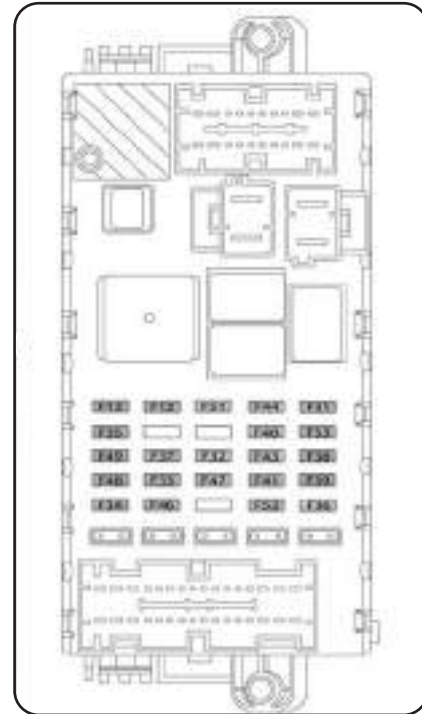

fig. 39

L0E0209m



Engine compartment fuse box fig. 40 and 41

A second fuse box is located on the right side of the engine compartment, next to the battery. To access this fuse box release the side tabs and remove cover L. The ID number of the electrical component corresponding to each fuse can be found on the back of the cover.



If you need to wash the engine compartment, take care not to directly aim for the engine compartment fuse box with the jet of water.

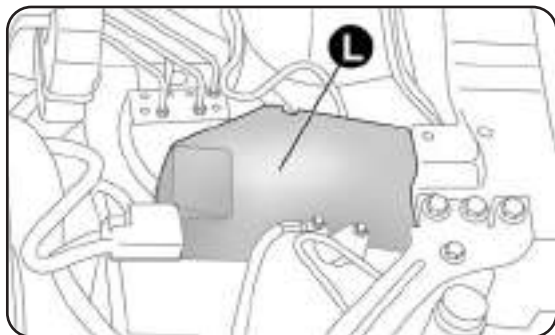

fig. 40

L0E0088m

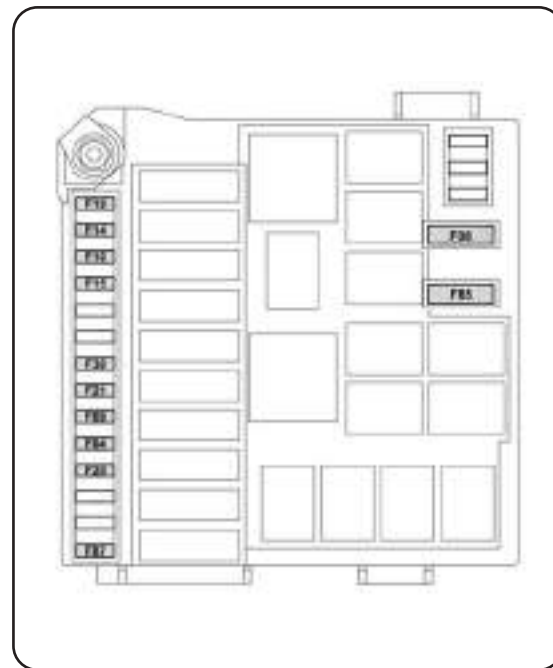

fig. 41

L0E0210m

Luggage compartment fuse box fig. 42 and 43

To gain access to the fuse box located on the left side of luggage compartment open the relevant inspection flap fig. 42.

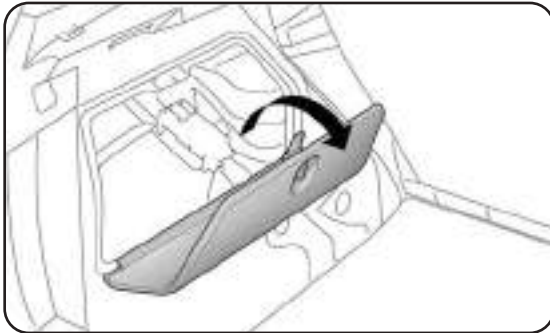

fig. 42

LOE0114m

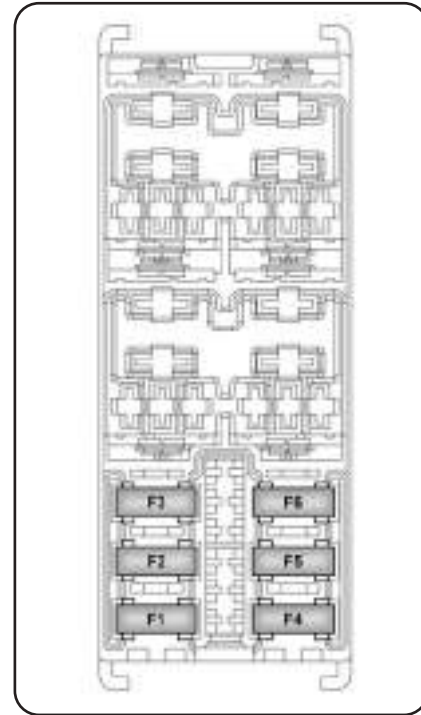

fig. 43

LOE0115m



FUSE SUMMARY TABLE

ELECTRIC DEVICES	FUSE	AMPERE	FIGURE
Right dipped beam headlight	F12	7.5	39
Right dipped beam headlight (Xenon gas discharge bulb)	F12	15	39
Left dipped beam headlight, headlight alignment corrector	F13	7.5	39
Left dipped beam headlight (Xenon gas discharge bulb)	F13	15	39
Climate control system fan relay coil, Body Computer	F31	5	39
Rear left electric window	F33	20	39
Rear right electric window	F34	20	39
Reversing lights, engine compartment junction unit relay coils, brake light pedal control (normally closed contact), water in diesel sensor, flow meter	F35	5	39
Central locking system control unit, fuel flap, dead lock, tailgate release	F36	20	39
Third brake light, instrument panel, Adaptive Headlights Node, control unit on left-hand gas discharge headlight	F37	7,5	39
Front roof lights, rear central roof light, driver side and passenger side sun visor lights, luggage compartment light, glove compartment light (Platinum trim level with optional sun roof)	F38	10	39
Radio setup/Radio/Radio Navigator, Blue&Me™ node, alarm siren, alarm system on roof light, climate control unit, tyre pressure monitoring control unit, diagnosis socket connector, rear roof lights	F39	10	39
Heated rear window	F40	30	39
Electric door mirror demisters, demisters on windscreen jets	F41	7.5	39

ELECTRIC DEVICES	FUSE	AMPERE	FIGURE
Windscreen wiper system on steering column stalk, bi-directional windscreen/rear window washer electrical pump system on steering column stalk	F43	30	39
Cigar lighter/power socket on tunnel, luggage compartment power socket	F44	15	39
Sun roof motor	F46	20	39
Driver's front electric window	F47	20	39
Passenger side front electric window	F48	20	39
Hazard, right, left and central control panels (lighting), steering wheel controls (lighting), controls on front roof light (lighting), volumetric alarm system control unit, electric sun roof system (control unit, control lighting), rain/dusk sensor, electro-chromic mirror, front seat heating controls, AUX socket (lighting)	F49	5	39
Cigar lighter (lighting), radio setup, Cruise Control system control, Blue&Me™ node, parking sensor node, AQS sensor, climate control system, electric door mirror adjustment, tyre pressure monitoring control unit, Lane assistance node, Controlled damping suspension node, Eco button (versions with automatic transmission), automatic transmission control light guide, control unit on right-hand gas discharge headlight	F51	5/7.5 (*)	39
Rear window wiper system on steering column stalk	F52	15	39
Instrument panel, rear direction indicators	F53	7.5	39



ELECTRIC DEVICES	FUSE	AMPERE	FIGURE
Climate control fan	F08	40	41
Headlight washer pump	F09	30	41
Horns	F10	15	41
Main beam headlights	F14	15	41
PTC1 additional heater	F15	30	41
Air conditioning compressor	F19	7.5	41
Fog/cornering lights	F30	15	41
Fuel pump	F85	15	41
Front right seat adjustment node	F1	30	43
Front left seat adjustment node	F2	30	43
Front left seat heating	F3	10	43
Front right seat heating	F6	10	43
Audio HI-FI control unit	F4	15	43
BASSBOX speaker (HI-FI system)	F5	10	43

BATTERY RECHARGING

IMPORTANT The battery recharging procedure is given as information only. You are advised to go to a Lancia Dealership to have this operation performed.

IMPORTANT After turning the ignition key to STOP and having closed the driver's side door, wait at least one minute before disconnecting and then reconnecting the battery electrical supply.

Charging should be slow at a low ampere rating for approximately 24 hours. Charging for a longer time may damage the battery.

To recharge, proceed as follows:

- disconnect the negative battery terminal;
- connect the charger leads to the battery terminals, observing the polarity;
- turn on the charger;
- when it is recharged, turn the charger off before disconnecting it from the battery;
- reconnect the negative battery terminal.



Battery fluid is poisonous and corrosive: avoid contact with skin and eyes. The battery recharging operation must be performed in a ventilated place, away from naked flames or possible sources of sparks to avoid the risk of explosion and fire.



Don't try to recharge a frozen battery: it must be thawed first, otherwise it may explode. If the battery was frozen, have it inspected by specialised personnel before recharging to check that the internal elements are not damaged and that the casing is not cracked, which causes the risk of leakage of poisonous, corrosive acid.



LIFTING THE CAR

If the car is to be lifted, go to a Lancia Dealership which is equipped with arm hoists or workshop lifts.

IMPORTANT Be careful when positioning the arm of the lift for versions with side skirts.

TOWING THE CAR

The tow hook, which is provided with the car, is housed in the tool box, under the luggage compartment mat.

FASTENING THE TOW RING fig. 44-45

Proceed as follows:

- release cap A;
- take the tow ring B from its housing in the tool box;
- screw the ring onto the rear or front threaded pin.

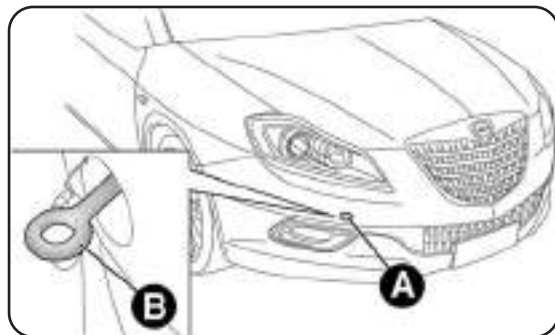

fig. 44

LOE0297m

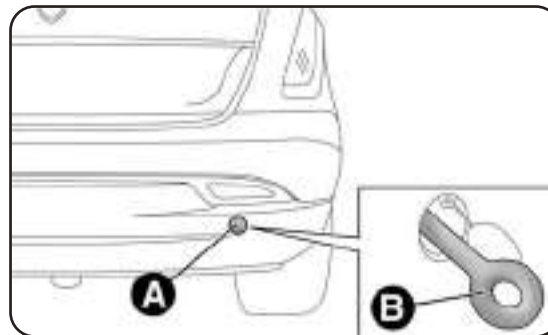

fig. 45

LOE0091m



Before towing, turn the ignition key to MAR and then to STOP without removing it. The steering column will automatically lock when the key is removed and the wheels cannot be steered.



When towing, remember that without the help of the brake servo and electric power steering, a greater effort is required on the pedal and steering wheel. Do not use flexible cables when towing and avoid jerky movements. During towing, make sure that the trailer hitch does not damage any components it is touching. When towing the car, it is compulsory to respect specific highway code regulations relating to the tow hook and procedures for towing on the road. Do not start the engine while towing the car. Before tightening the ring clean the threaded housing thoroughly. Make sure that the ring is securely fastened before towing the car.



*The front and rear tow hooks must only be used for emergency situations on the road. The car may be towed for short distances when a dedicated device is used in compliance with the Highway Code (rigid bar), and in order to move the vehicle on the road in preparation for towing or transport via a breakdown vehicle. Tow hooks **MUST NOT** be used to tow vehicles off the road or where there are obstacles and/or for towing operations using cables or other non-rigid devices. Respecting the above conditions, towing must take place with two vehicles (one towing, the other towed) aligned as much as possible along the same centre line.*

Scheduled servicing	234
Scheduled servicing plan	235
Periodic checks	237
Demanding use of the car	237
Checking levels	239
Air cleaner/Pollen filter/Diesel filter	243
Battery	244
Wheels and tyres	247
Rubber hoses	249
Windscreen/rear window wiper	249
Bodywork	252
Interiors	256

SCHEDULED SERVICING

Correct servicing is crucial for guaranteeing a long life for the car under the best conditions.

For this reason, Lancia has planned a series of checks and services at fixed distance intervals and, for versions/markets, where provided, at fixed time intervals, as described in the Scheduled Servicing Plan.

Regardless of the above, it is always necessary to carefully follow the instructions in the Scheduled Servicing Plan (e.g. periodically check level of liquids, tyre pressure, etc.).

Scheduled Servicing is offered by all Lancia Dealerships according to fixed time or kilometres/miles intervals. If, during each operation, in addition to the ones scheduled, the need arises for further replacements or repairs, these may be carried out only with the explicit agreement of the Customer. If your car is used frequently for towing, the interval between one service operation and the next should be reduced.

IMPORTANT

The Scheduled Servicing services are set out by the Manufacturer. Failure to have them carried out may invalidate the warranty.

It is advisable to inform a Lancia Dealership of any small operating irregularities without waiting for the next service.

For versions equipped with specific supply (e.g. LPG) and/or trim level, in addition to what is described in the following Scheduled Servicing Plan, refer to the relevant additional items in the dedicated supplements.



SCHEDULED SERVICING PLAN

The checks listed in the Scheduled Servicing Plan, after reaching 120,000 km/6 years, must be cyclically repeated starting from the first interval, thus following the same intervals as before.

Thousands of miles	12	24	36	48	60	72	84	96	108	120
Thousands of km	20	40	60	80	100	120	140	160	180	200
Years	1	2	3	4	5	6	7	8	9	10
Check tyre condition/wear and adjust pressure, if necessary; check "Fix&Go Automatic" kit recharge expiry date (for versions/markets, where provided)	●	●	●	●	●	●	●	●	●	●
Check operation of lighting system (headlamps, direction indicators, hazard warning lights, luggage compartment, oddment compartment, instrument panel warning lights, etc.)	●	●	●	●	●	●	●	●	●	●
Check and, if necessary, top-up fluid levels (brakes/hydraulic clutch, screen washer, battery, engine cooling, etc.)	●	●	●	●	●	●	●	●	●	●
Check exhaust fumes/emissions	●	●	●	●	●	●	●	●	●	●
Use the diagnosis socket to check supply/engine management system operation; emissions and, for versions/markets, where provided, engine oil degradation	●	●	●	●	●	●	●	●	●	●
Visually inspect condition of: exterior bodywork, underbody protection, rigid and flexible pipes (exhaust-fuel system-braking system), rubber elements (boots, hoses, bushes, etc.)	●		●		●		●		●	
Check windscreen/rear window wiper blade position/wear	●		●		●		●		●	
Check operation of windscreen wiper/washer system and adjust jets, if necessary	●		●		●		●		●	
Check cleanliness of bonnet and boot locks, cleanliness and lubrication of linkage		●		●		●		●		●

Thousands of miles	12	24	36	48	60	72	84	96	108	120
Thousands of km	20	40	60	80	100	120	140	160	180	200
Years	1	2	3	4	5	6	7	8	9	10
Check handbrake lever travel and adjust, if required		●		●		●		●		●
Visual inspection of condition and wear of front disc brake pads and operation of pad wear indicator	●	●	●	●	●	●	●	●	●	●
Visual inspection of condition and wear of rear disc brake pads	●	●	●	●	●	●	●	●	●	●
Visual inspection of condition and tensioning of accessory drive belt(s) (for versions without automatic tensioner only)		●						●		
Replace engine oil and replace oil filter (versions with DPF) (1)										
Replace accessory drive belt(s) (2)						●				
Replace toothed timing drive belt (2)						●				
Replace fuel filter (3)			●			●			●	
Replace air cleaner cartridge (4)		●		●		●		●		●
Replace brake fluid		●		●		●		●		●
Passenger compartment filter replacement (4)	○	●	○	●	○	●	○	●	○	●

(1) The actual interval for changing the oil and replacing the engine oil filter depends on the vehicle usage conditions and is signalled by the warning light or message in the instrument panel. Anyway, it must never exceed 2 years.

If the car is mainly used in towns and cities, change the engine oil and filter every year.

(2) Areas that are not dusty: advised maximum mileage 120,000 km. Regardless of the mileage, the belt must be replaced every 6 years.
Dusty areas and/or demanding use of the car (cold climates, town use, long periods of idling): advised maximum mileage 60,000 km. Regardless of the mileage, the belt must be replaced every 4 years.

(3) If the car runs on fuel with quality below the relevant European specification, this filter must be replaced every 20,000 km

(4) If the car is used in dusty areas, this cleaner must be replaced every 20,000 km.

○ Recommended operations.

● Mandatory operations.

PERIODIC CHECKS

Every 1,000 km or before long journeys, check and, if necessary, top up the following:

- engine coolant fluid level;
- brake fluid level;
- windscreen washer fluid level;
- tyre pressure and condition;
- operation of lighting system (headlights, direction indicators, hazard warning lights, etc.);
- operation of the windscreen/rear window wiper/washer system, position and wear of windscreen/rear window wiper blades;

Every 3,000 km check and top up if required: engine oil level.

DEMANDING USE OF THE CAR

Should the prevailing use of the car be under one of the following specially demanding conditions:

- trailer or caravan towing;
- dusty roads;
- short (less than 7-8 km) and repeated journeys in sub-zero temperatures;
- engine often idling or driving long distances at low speeds or prolonged inactivity;

The following checks must be carried out more often than indicated in the Scheduled Servicing Plan:

- check front disc brake pad condition and wear;
- check cleanliness of bonnet and luggage compartment locks, as well as cleanliness and lubrication of linkages;
- visually inspect condition of: engine, gearbox, transmission, pipes and hoses (exhaust – fuel supply system - brakes) rubber elements (boots – hoses - bushes, etc.);
- check battery charge and fluid level (electrolyte);
- visually inspect the condition of auxiliary drive belts;
- check air cleaner and replace it, if required.

CHECKING LEVELS

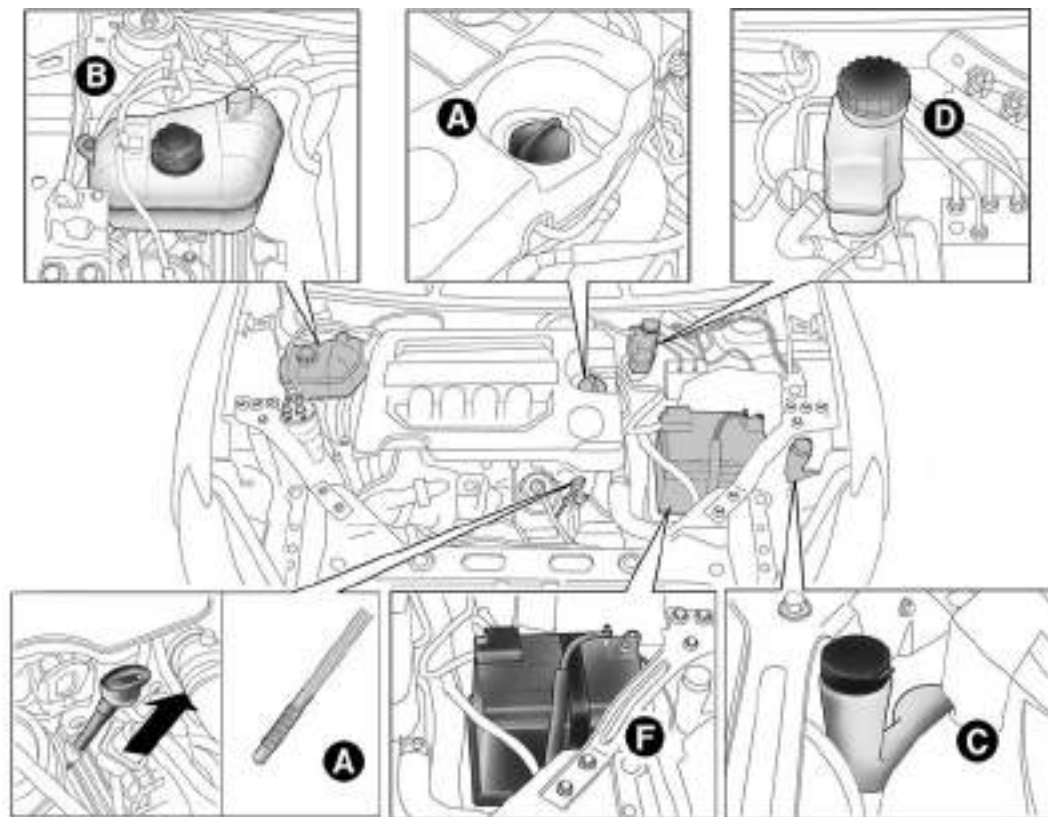

fig. 1

ENGINE OIL A - Fig. 1

Check the oil level a few minutes (about five) after the engine has stopped, with the car parked on level ground. The oil level should be between the MIN and MAX marks on the dipstick. The range between the MIN and MAX marks corresponds to about 1 litre of oil.

If the level of the oil is close to or below the MIN mark, add oil via the filler neck until the MAX mark is reached. The oil level must never exceed the MAX mark.

Engine oil consumption

The maximum engine oil consumption is usually 400 grams every 1,000 km. When the car is new, the engine needs to run in, therefore the engine oil consumption can only be considered stabilised after the first 5,000 - 6,000 km.

IMPORTANT The oil consumption depends on driving style and car usage conditions.

IMPORTANT After adding or changing the oil, let the engine run for a few seconds and wait a few minutes after turning it off before you check the level.



When the engine is hot, take care when working inside the engine compartment to avoid burns. Remember that when the engine is hot, the fan may operate: danger of injury. Pay attention to scarves, ties and other loose fitting garments: they may get caught by moving components.



Do not add any oil with different specifications than those of the existing engine oil.



The used engine oil and the replaced oil filter contain substances that may be dangerous for the environment. It is advisable to have oil and filters changed by a Lancia Dealership where they will be disposed of according to the law.

ENGINE COOLANT B - Fig. 1

The coolant level must be checked when the engine is cold and must range between the MIN and MAX marks on the reservoir. If the level is low, slowly pour a mixture of 50% demineralised water and 50% PARAFLU^{UP} of PETRONAS LUBRICANTS through the filler neck until the level reaches MAX.

The mixture of 50% PARAFLU^{UP} and 50% distilled water protects against freezing down to temperatures of -35°C. For particularly harsh climate conditions, we recommend using a mixture of 60% PARAFLU^{UP} and 40% distilled water.



PARAFLU^{UP} anti-freeze is used in the engine cooling system. Use the same fluid as in the cooling system when topping up. PARAFLU^{UP} cannot be mixed with any other type of fluid. If this occurs, do not start the engine and contact your Lancia Dealership immediately.



The cooling system is pressurised. If necessary, only replace the plug with another original one or the operation of the system may be adversely affected. Do not remove the cap from the reservoir when the engine is hot: danger of scalding.

WINDSCREEN/REAR WINDOW WASHER FLUID C - fig. 1

Remove the cap, operating on the special tab, to add fluid.

Use a mixture of water and TUTELA PROFESSIONAL SC35 fluid, in the following concentrations:

- 30% TUTELA PROFESSIONAL SC35 and 70% water in summer.
- 50% TUTELA PROFESSIONAL SC35 and 50% water in winter.

In case of temperatures below -20°C , use undiluted TUTELA PROFESSIONAL SC35 fluid.

Check fluid level through the reservoir.

Close the plug by pressing the centre section.



Do not travel with the windscreen washer fluid reservoir empty: the windscreen washer is essential for improving visibility.

Some commercial windscreen washer additives are flammable. The engine compartment contains hot parts which could cause a fire if they come into contact with these additives.

BRAKE FLUID D - Fig. 1

Undo the plug and check that the liquid contained in the reservoir is at the maximum level. The fluid level in the reservoir must not exceed the MAX mark. If you need to top up, you should use the brake fluid shown in the “Fluids and lubricants” table (see chapter “6”).

NOTE Carefully clean the plug of the reservoir and the surrounding surface.

Take great care to ensure that impurities do not enter the reservoir when the plug is opened.

For topping-up, always use a funnel with integrated filter with mesh equal to or lower than 0.12 mm.

IMPORTANT Brake fluid is hygroscopic (i.e. it absorbs moisture). For this reason, if the car is mainly used in areas with a high degree of atmospheric humidity, the fluid should be replaced at more frequent intervals than specified in the “Scheduled Servicing Plan”.



Prevent brake fluid which is highly corrosive from coming into contact with painted parts. Should this occur, immediately wash with water.



Brake fluid is poisonous and highly corrosive. In the event of accidental contact, immediately wash the affected parts with water and mild soap. Then rinse thoroughly. In case of swallowing immediately call a doctor.



The © symbol, on the container, indicates a synthetic brake fluid, which is different from a mineral fluid. Use of a mineral type fluid will damage the special rubber seals of the braking system beyond repair.

AIR CLEANER/POLLEN FILTER/DIESEL FILTER

For filter replacement, contact a Lancia Dealership.

BATTERY

The car is fitted with a low-maintenance battery F - fig. 1: no electrolyte top-ups with distilled water are needed in standard conditions of use.

It does need to be checked regularly at a Lancia Dealership or by specialised personnel to make sure that it is working properly.



Battery fluid is poisonous and corrosive. Avoid contact with skin and eyes. Keep naked flames or possible sources of sparks away from the battery: risk of explosion or fire.



Using the battery when the fluid is too low can damage it irreparably and generate a risk of explosion.

REPLACING THE BATTERY

If required, replace the battery with a genuine spare part with the same specifications.

If a battery with different specifications is fitted, the service intervals given in the “Scheduled Servicing Plan” will no longer be valid.

Follow the battery manufacturer’s instructions for maintenance.

Advanced ESP system

If the battery is disconnected, the  warning light will switch on (together with a message in the display) to indicate that the system must be realigned. To switch the warning light off, carry out the following initialisation procedure:

- turn the ignition key to MAR;
- turn the steering wheel fully both clockwise and anti-clockwise (to move from the position with the wheels straight);
- turn the ignition key to STOP and then to MAR.

If the  warning light does not go out after a few seconds, go to a Lancia Dealership.



Incorrect installation of electric and electronic devices may cause severe damage to your car. Go to a Lancia Dealership if you want to install accessories (anti-theft system, radio phone, etc.): they will suggest the most suitable devices and advise you if a higher capacity battery needs to be installed.



If the vehicle must remain unused for a long time at very low temperature, remove the battery and carry it to a warm place, in order to avoid freezing.



When you must perform any operation on the battery or near it, always protect your eyes with special goggles.



Batteries contain substances that can be very dangerous for the environment. It is advisable to have the battery changed by a Lancia Dealership where it will be disposed of according to the law.

USEFUL ADVICE FOR EXTENDING THE LIFE OF YOUR BATTERY

To avoid draining your battery and make it last longer, observe the following instructions:

- when you park the car, ensure the doors, tailgate and bonnet are closed properly, to prevent any light from remaining on inside the passenger compartment;
- turn off the internal roof lights, although the car does have an automatic system for switching off internal lights;
- do not leave devices (e.g. car radio, hazard warning lights, etc.) switched on for a long time when the engine is not running;
- before performing any operation on the electrical system, disconnect the negative battery cable;
- battery terminals should always be perfectly tightened.

IMPORTANT If the charge level remains under 50% for a long time, the battery is damaged by sulphation, reducing its capacity and efficiency at start-up.

The battery will also be more at risk of freezing (this can happen as early as -10°C). In case of prolonged idling, refer to the “Car inactivity” paragraph, in chapter “3”.

If, after purchasing your car, you decide to install electrical accessories which require a permanent electric power supply (alarm, etc.) or accessories which have a serious impact on the electrical balance, contact a Lancia Dealership: their qualified personnel will suggest the most suitable Lancia Lineaccessori devices and assess the overall electric consumption, checking whether the car’s electrical system can cope or whether a more powerful battery is required.

Since some of these devices continue to consume electricity even when the engine is off, they gradually run down the battery.

WHEELS AND TYRES

Check the pressure of each tyre, including the space-saver wheel, approximately every two weeks and before long journeys: the pressure should be checked with the tyre rested and cold.

It is normal for the pressure to increase as the car is used; see the “Wheels” paragraph in chapter “6” for the correct tyre inflation pressure.

Incorrect pressure causes abnormal tyre wear fig. 2:

A normal pressure: tread evenly worn.

B low pressure: tread particularly worn at the edges.

C high pressure: tread particularly worn in the centre.

The tyres must be replaced when the tread is less than 1.6 mm thick. In any case, follow the laws in force in the country you are in.

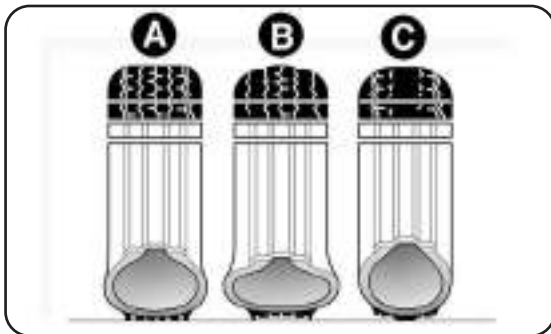

fig. 2

L0E0096m

IMPORTANT

- Where possible, avoid braking suddenly, wheel-spinning and crashing into curbs, potholes or other obstacles. Driving for long stretches over bumpy roads can damage the tyres;
- check the tyres regularly for cuts on the sides, swellings or irregular tread wear. Go to a Lancia Dealership if required.
- avoid overloading the car when travelling: this may cause serious damage to the wheels and tyres;
- if a tyre is punctured, stop immediately and change it to avoid damage to the tyre, wheel rim, suspension and steering system;
- the tyre ages even if rarely used. Cracks in the tread and on the side walls are a sign of ageing. Have the tyres checked by specialised personnel if they have been fitted for longer than 6 years. Remember to check the space-saver wheel very carefully;
- when replacing the tyres, always fit new tyres, avoiding those of dubious origin;

- if a tyre is replaced, you should also change the inflation valve;
- to allow even wear between the front and rear tyres, it is advisable to change them over every 10-15 thousand kilometres, keeping them on the same side of the car so as not to reverse the direction of rotation.



Remember that the road holding qualities of your car also depend on the correct inflation pressure of the tyres.



If the pressure is too low the tyre will get overheated, with the risk of serious damage to the tyre.



Avoid moving the tyres from the right side of the vehicle to the left side and vice versa.



Do not repaint alloy wheel rims at temperatures higher than 150°C. The mechanical specifications of the wheels might be adversely affected.

RUBBER HOSES

As far as the brake system and fuel supply system rubber hoses are concerned, follow the “Scheduled Servicing Plan” in this chapter carefully.

Ozone, high temperatures and prolonged lack of fluid in the system may cause hardening and cracking of the hoses, with possible leaks. Careful checking is therefore necessary.

WINDSCREEN/ REAR WINDOW WIPER

BLADES

Periodically clean the rubber part using special products; TUTELA PROFESSIONAL SC35 is recommended.

Replace the blades if the rubber edge is deformed or worn. In any case, it is advisable to replace them approximately once a year.

A few simple precautions can reduce the possibility of damage to the blades:

- make sure that the rubber part is not frozen to the windscreen in case of sub-zero temperatures. Use a de-icing product to release it if required;
- remove any snow from the glass: in addition to protecting the blades, this prevents effort from the motor and overheating;
- do not operate the windscreen and the rear window wipers on dry glass.



Driving with worn windscreen wiper blades is a serious hazard, because visibility is reduced in bad weather conditions.

Replacing the windscreen wiper blades fig. 3

Proceed as follows:

- lift the windscreen wiper arm and position the blade so that it forms an angle of 90° with the arm;
- press tab A and remove the blade from the arm;
- insert the new blade making sure it is locked into place.

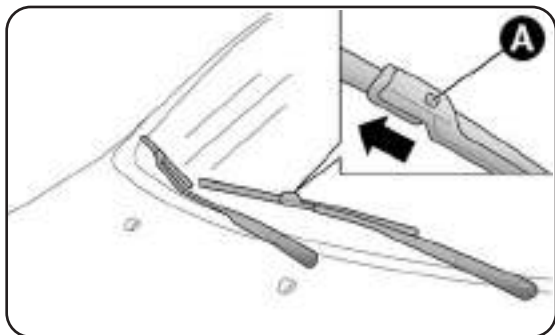

fig. 3

LOE0097m

Changing the rear window wiper blade fig. 4

Proceed as follows:

- raise cover A and remove the arm from the car, slackening nut B that fastens it to the pivot pin;
- fit the new arm, positioning it correctly, and fully tighten the nut;
- lower the cover.

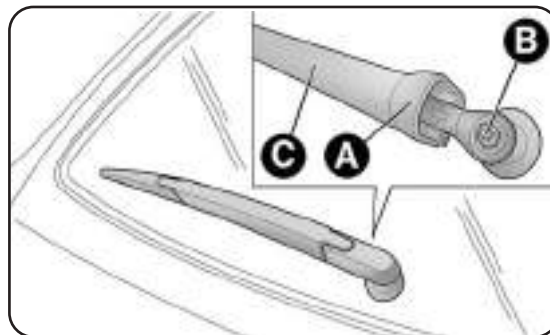

fig. 4

LOE0095m

NOZZLES

Windscreen washer fig. 5

If the jet of fluid is inadequate, firstly check that there is fluid in the reservoir: (see “Checking levels” paragraph in this chapter).

Then check that the nozzle holes are not clogged, if necessary clean them using a needle.

The windscreen jets are directed by adjusting the nozzle angle.

The jets should be directed at about a third of the height from the top edge of the windscreen.

IMPORTANT In versions with a sun roof, make sure that the sun roof is closed before operating the front jets.

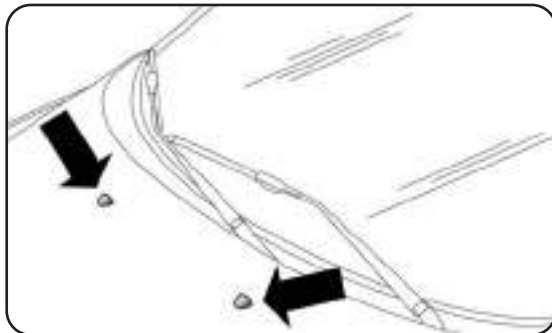

fig. 5

LOE009m

Rear window washer fig. 6

The rear window washer jets are fixed. The nozzle holder is located above the rear window.

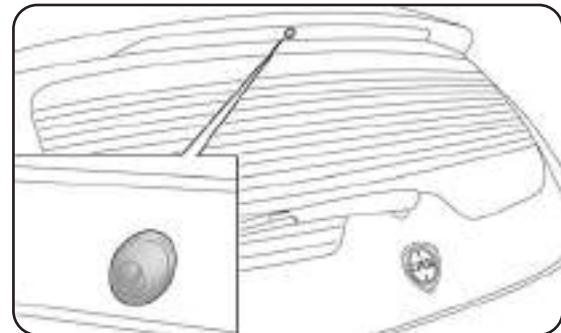

fig. 6

LOE0100m

BODYWORK

PROTECTION AGAINST ATMOSPHERIC AGENTS

The main causes of corrosion are the following:

- atmospheric pollution;
- salty air and humidity (coastal areas, or hot humid climates);
- seasonal environmental conditions.

The abrasive action of wind-borne atmospheric dust and sand, as well as mud and gravel raised by other cars is also not to be underestimated.

On your car, Lancia has implemented the best manufacturing technologies to effectively protect the bodywork against corrosion.

These include:

- paint products and systems which give the car a special resistance to corrosion and abrasion;
- use of galvanised (or pre-treated) steel sheets with high resistance to corrosion;
- spraying the underbody, engine compartment, wheel arch internal parts and other elements with highly protective wax-based products;
- spraying protective plastic materials in the most exposed areas: underdoor, inner wing parts, edges, etc.;
- using “open” boxed sections to prevent condensation and pockets of moisture from causing rust inside.

BODY AND UNDERBODY WARRANTY

Your car is covered by warranty against perforation due to rust of any original element of the structure or bodywork.

For the general terms of this warranty, refer to the Warranty Booklet.

ADVICE FOR PRESERVING THE BODYWORK

Paintwork

Paintwork does not only serve an aesthetic purpose, but also protects the underlying sheet metal.

Touch up abrasions and scratches immediately to prevent rust formation. Use only original paint products for touch-ups (see “Bodywork paint identification plate” in the “Technical specifications” chapter).

Normal maintenance of paintwork consists in washing the car: the frequency depends on the conditions and environment where the car is used. For example, in highly polluted areas, or if the roads are spread with salt, it is advisable to wash the car more frequently.

To correctly wash the car, proceed as follows:

- if taking your car through an automatic car wash, remove the aerial from the roof to avoid damaging it;
- in washing stations keep the steam jets/high pressure washing nozzles at least 40 cm away from the bodywork to prevent damage. It should be remembered that the build up of water can damage the car over a period of time;

- wash the bodywork using a low pressure jet of water;
- wipe a sponge with a slightly soapy solution over the bodywork, frequently rinsing the sponge;
- rinse well with water and dry with a jet of air or a chamois leather.

Dry the less visible parts with special care, such as the door frames, bonnet and the headlight frames, where water may stagnate more easily. The car should not be taken to a closed area immediately, but left outside so that residual water can evaporate.

Do not wash the car after it has been left in the sun or with the bonnet hot: this may alter the shine of the paintwork. Exterior plastic parts must be cleaned in the same way as the rest of the car.

Where possible, do not park under trees; the resinous substance that many species release give the paint a dull appearance and increase the possibility of triggering rusting processes.

Hard Black versions



Avoid washing with rollers and/or brushes in washing stations. Then, wash the car, only by hand, using pH-neutral detergents; dry it with a wet chamois leather. Abrasive products and/or polishes should not be used for cleaning the car. Bird droppings must be washed off immediately and thoroughly as the acid they contain is particularly aggressive. Avoid (if at all possible) parking the car under trees; remove vegetable resins immediately as, when dried, it may only be possible to remove them with abrasive products and/or polishes, which is highly inadvisable as they could alter the typical opacity of the paint. Do not use pure windscreen washer fluid for cleaning the front windscreen and rear window; dilute it min. 50% with water.

IMPORTANT Bird droppings must be washed off immediately and thoroughly, as the acid they contain is particularly aggressive.



Detergents pollute the environment. Only wash the car in areas equipped for the collection and purification of the fluids used in the washing process.



In order to preserve the aesthetic appearance of the paintwork abrasive products and/or polishes should not be used for cleaning the car.

Windows

Use specific detergents and clean cloths to prevent scratching or altering the transparency.

IMPORTANT Wipe the inside surface of the rear window gently with a cloth in the direction of the filaments to avoid damaging the heater coils.

Engine compartment

At the end of each winter, thoroughly wash the engine compartment, taking care to avoid spraying the water jet directly onto the electronic control units and the relay/fuse box on the left side of the engine compartment (driving direction). Have this operation performed at a specialised workshop.

IMPORTANT The washing should take place with the engine cold and the ignition key in the STOP position. After the washing operation, make sure that the various protections (e.g. rubber caps and guards) have not been removed or damaged.

Front headlights

Use a soft cloth soaked in water and detergent for washing cars.

IMPORTANT Never use aromatic substances (e.g. petrol) or ketones (e.g. acetone) for cleaning the plastic lenses of the front headlights.

IMPORTANT When cleaning the car with a pressure washer, keep the water jet at least 20 cm away from the headlights.

INTERIORS

Periodically check that water is not trapped under the mats (due to water dripping off shoes, umbrellas, etc.) which could cause oxidation of the sheet metal.



Never use flammable products, such as petrol ether or rectified petrol to clean the inside of the car. The electrostatic charges which are generated by rubbing during cleaning may cause a fire.



Do not keep aerosol cans in the vehicle; these could explode. Aerosol cans must not be exposed to temperatures exceeding 50°C. When the vehicle is exposed to sunlight, the temperature inside can greatly exceed this value.

SEATS AND FABRIC PARTS

Remove dust with a soft brush or a vacuum cleaner. It is advisable to use a moist brush on velvet upholstery. Rub the seats with a sponge moistened with a solution of water and neutral detergent.

PLASTIC PARTS

It is advisable to clean interior parts with a moist cloth and a solution of water and non-abrasive mild soap. Use specific products for cleaning plastic, without solvents and specifically designed to prevent damage to the appearance and colour of the treated parts, to remove grease and tough stains.

IMPORTANT Do not use alcohol, petrols or derivatives to clean the instrument panel lens.



Identification data	258
Engine codes - bodywork versions	260
Engine	261
Fuel supply system	262
Transmission	262
Brakes	263
Suspension	263
Steering	263
Wheels	264
Dimensions	269
Performance	270
Weights	271
Capacities	272
Fluids and lubricants	273
Fuel consumption	275
CO ₂ emissions	276

IDENTIFICATION DATA

The vehicle identification details are, fig. 1:

- 1 V.I.N. plate (located in the engine compartment, to the side of the right shock absorber upper mounting);
- 2 Bodyshell marking (located on the passenger compartment floor, next to the passenger side front seat);
- 3 Bodywork paint identification plate (located on the inside of the tailgate);
- 4 Engine marking (located on the left rear section, gear-box side).

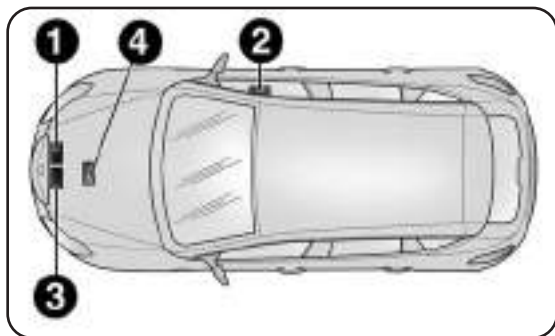

fig. 1

LOE0116m

V.I.N. PLATE fig. 2

This plate is fitted to the engine compartment front cross-member and contains the following data:

- B Type-approval number.
- C Vehicle type identification code.
- D Chassis number.
- E Maximum authorised weight of vehicle fully laden.
- F Maximum authorised weight of vehicle fully laden plus trailer.
- G Maximum authorised weight on first axle (front).
- H Maximum authorised weight on second axle (rear).
- I Engine type.
- L Bodywork version code.
- M Spare parts number.
- N Correct value of smoke coefficient (for diesel engines)

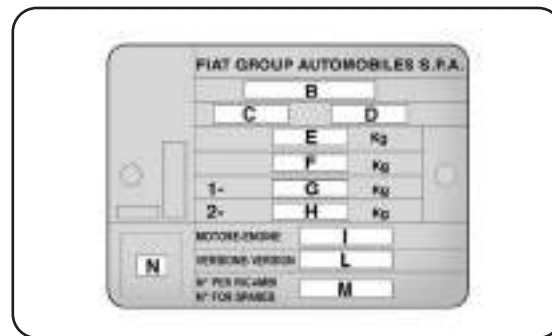

fig. 2

LOE0117m



CHASSIS MARKING fig. 3

This is printed on the passenger compartment floor, next to the front right seat. Slide flap A forward to access. The marking includes:

- vehicle type (ZAR 844000)
- chassis number

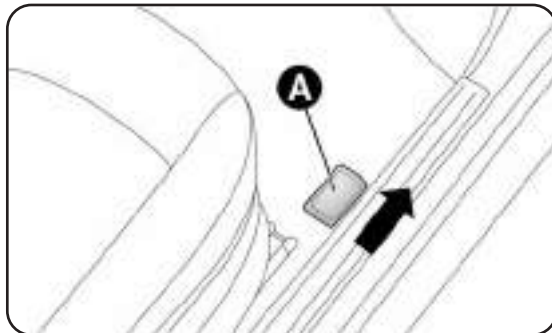

fig. 3

L0E011Sm

BODYWORK PAINT IDENTIFICATION PLATE fig. 4

This plate is applied inside the bonnet and shows the following data:

- A Paint manufacturer.
- B Colour name.
- C Lancia colour code.
- D Respray and touch-up colour code.

ENGINE MARKING

Engine marking is stamped on the cylinder block and includes the model and the chassis serial number.

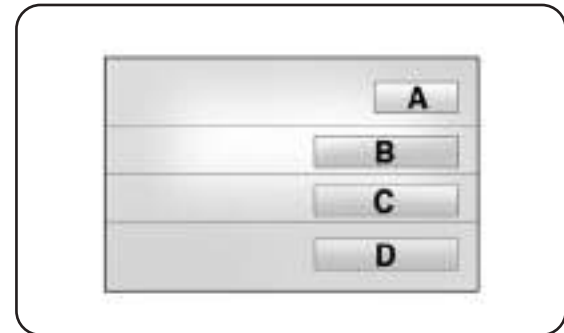

fig. 4

L0E0119m

ENGINE CODES - BODYWORK VERSIONS

VERSIONS	ENGINE CODE	BODYWORK VERSION
1.6 Multijet 105 HP	844A3000	844AXP1A 13B 844AXP1A 13C (*)
1.6 Multijet 120 HP	198A2000	844AXC1A 02L 844AXC1A 02M (*)

(*) Versions where 18" tyres may be fitted



ENGINE

GENERAL INFORMATION		1.6 Multijet 105 HP	1.6 Multijet 120 HP
Type code		844A3000	198A2000
Cycle		Diesel	Diesel
Number and arrangement of cylinders		4 in line	4 in line
Piston bore and stroke	mm	79.5 × 80.5	79.5 × 80.5
Total displacement	cm ³	1598	1598
Compression ratio		16.5 ± 0.4	16.5 ± 0.4
Max. power (EC)	kW HP	77 105	88 120
corresponding speed	rpm	4000	4000
Max. torque (EC)	Nm kgm	300 31	300 31
corresponding speed	rpm	1500	1500
Fuel		Diesel fuel for motor vehicles (EN590 specification)	Diesel fuel for motor vehicles (EN590 specification)

FUEL SUPPLY SYSTEM

Fuel supply system	Common Rail MultiJet direct injection electronically controlled with turbo and intercooler
--------------------	--



Modifications or repairs to the fuel supply system that are not carried out properly or do not take the system's technical specifications into account can cause malfunctions leading to the risk of fire.

TRANSMISSION

Gearbox	Six forward speed plus reverse with synchronisers for the engagement of the forward speeds
Clutch	Self-adjusting pedal without idle stroke
Drive	Front



BRAKES

Service brakes:	
– front	Self-ventilated discs
– rear	Disc
Parking brake	Controlled by hand lever, acting on rear brakes

IMPORTANT Water, ice and road salt spread on roads may deposit on the brake discs thus reducing braking efficiency when braking for the first time.

SUSPENSIONS

Front suspensions	McPherson independent wheels
Rear suspensions	Interconnected wheels with torsion beam

STEERING

Type		Rack and pinion with electric power steering
Turning circle (kerb to kerb)	m	10.6 / 11.2 (*)

(*) With 18" tyres

WHEELS

RIMS AND TYRES

Pressed steel or alloy rims. Tubeless radial carcass tyres. All approved tyres are listed in the Vehicle Registration Document.

IMPORTANT In the event of discrepancies between the information provided in this “Owner’s handbook” and the “Registration Document”, consider the specifications shown in the log book only. For safe driving, the car must be fitted with tyres of the same make and type on all wheels.

IMPORTANT Do not use air chambers with Tubeless tyres.

SPACE-SAVER WHEEL

Pressed steel rim. Tubeless tyre.

WHEEL GEOMETRY

Total front toe in: -1 ± 1 mm

Total rear toe in: 2 ± 2 mm

The figures refer to the car in running order.

UNDERSTANDING TYRE MARKING **fig. 5**

Example: 195/55 R 16 91 V

195 = Nominal width (S, distance in mm between sidewalls).

55 = Height/width ratio (H/S) as a percentage.

R = Radial tyre.

16 = Rim diameter in inches (\emptyset).

91 = Load index (capacity).

V = Maximum speed index.

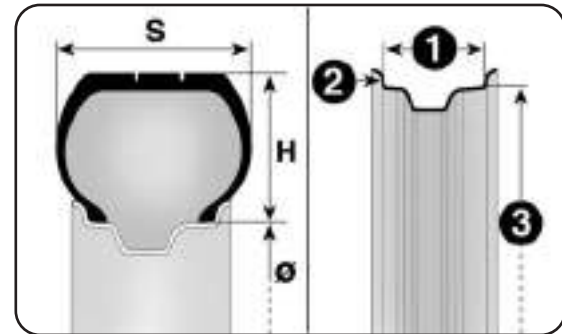

fig. 5



Load index (capacity)

60 = 250 kg	84 = 500 kg
61 = 257 kg	85 = 515 kg
62 = 265 kg	86 = 530 kg
63 = 272 kg	87 = 545 kg
64 = 280 kg	88 = 560 kg
65 = 290 kg	89 = 580 kg
66 = 300 kg	90 = 600 kg
67 = 307 kg	91 = 615 kg
68 = 315 kg	92 = 630 kg
69 = 325 kg	93 = 650 kg
70 = 335 kg	94 = 670 kg
71 = 345 kg	95 = 690 kg
72 = 355 kg	96 = 710 kg
73 = 365 kg	97 = 730 kg
74 = 375 kg	98 = 750 kg
75 = 387 kg	99 = 775 kg
76 = 400 kg	100 = 800 kg
77 = 412 kg	101 = 825 kg
78 = 425 kg	102 = 850 kg
79 = 437 kg	103 = 875 kg
80 = 450 kg	104 = 900 kg
81 = 462 kg	105 = 925 kg
82 = 475 kg	106 = 950 kg
83 = 487 kg	

Maximum speed index

Q = up to 160 km/h.	H = up to 210 km/h.
R = up to 170 km/h.	V = up to 240 km/h.
S = up to 180 km/h.	W = up to 270 km/h.
T = up to 190 km/h.	Y = up to 300 km/h.
U = up to 200 km/h.	

**Maximum speed index
for snow tyres**

QM + S = up to 160 km/h.
TM + S = up to 190 km/h.
HM + S = up to 210 km/h.

UNDERSTANDING RIM MARKING fig. 5

Example: 7J x 16 H2 ET 31

7 = rim width in inches (1).

J = rim drop centre outline (side projection where the tyre bead rests) (2).

16 = rim nominal diameter in inches (corresponds to the diameter of the tyre to be mounted) ($3 = \emptyset$).

H2 = shape and number of humps (circumference projection which holds tubeless tyre beads on the rim).

ET 31 = wheel camber angle (distance between the disc/rim supporting plane and the wheel rim centre line).

RIM PROTECTOR TYRES fig. 6

Do NOT fit wheel caps when using integral wheel caps fixed (with springs) to the steel rim and after-sale tyres provided with Rim Protector (fig. 5a). The use of unsuitable tyres and wheel caps may cause sudden loss of tyre pressure.



fig. 6



Rims	Tyres	Tyres for snow	Space-saver wheel (for versions/markets, where provided)	
			Rim	Tyre
7Jx16" - ET31 7Jx16" - ET31 7Jx17" - ET31 7,5Jx18" - ET35 (**) 	195/155R16-91V (■) 205/55 R16-91V 225/45 R17-91W 225/40 R18-92W(□) (**) REINFORCED	195/55R16-91T (■) (M+S) 205/55 R16-91T (M+S) 225/45 R17-91T (M+S) 225/40 R18-92T (M+S)	4Bx15" H-ET 35 (*)	125/90 R15-96M (*)

(■) 1.6 Multijet 120 HP versions

(*) Depending on the trim level, the space-saver wheel for the 1.6 Multijet 120 HP version has a 205/55 R16-91V tyre and a 7Jx16" - ET31 rim. In this case the 205/55 R16 91V tyre has the same specifications as the space-saver wheel: the information in "Replacing a wheel" paragraph therefore refers to the 205/55 R16 91V tyre.

(**) For versions/markets, where provided

(□) Tyre not suitable for fitting snow chains.



On 205/55 R16-91V tyres, use reduced size snow chains with a maximum projection of 9 mm beyond the tyre profile. On 225/45 R17-91W tyres, use reduced size snow chains with a maximum projection of 7 mm beyond the tyre profile.

IMPORTANT Special techniques need to be adopted for 225/40 R18 92W tyres. For this reason, these tyres can only be requested when the vehicle is purchased. Do not fit this tyre after vehicle has been purchased !

COLD TYRE INFLATION PRESSURES (bar)

Size	TYRES PROVIDED			
	Medium load		Full load	
	Front	Rear	Front	Rear
195/55 R16-91V	2.4	2.2	2.7	2.5
205/55 R16-91V	2.4	2.2	2.7	2.5
225/45 R17-91W	2.4	2.2	2.7	2.5
225/40 R18-92W	2.6	2.4	2.9	2.7

SPACE-SAVER/SPARE WHEEL

Size	Inflation pressure
205/55 R16-91V	2.2
125/90 R15-96	4.2

Add +0.3 bar to the prescribed pressure when the tyres are warm. Check correct pressure when the tyres are cold.

With snow tyres, add +0.2 bar to the prescribed pressure for standard tyres.

When travelling at speeds over 160 km/h, inflate the tyres to the values specified for fully laden conditions.

The TPMS is not fitted with 195/55 R16 91V tyres.



DIMENSIONS

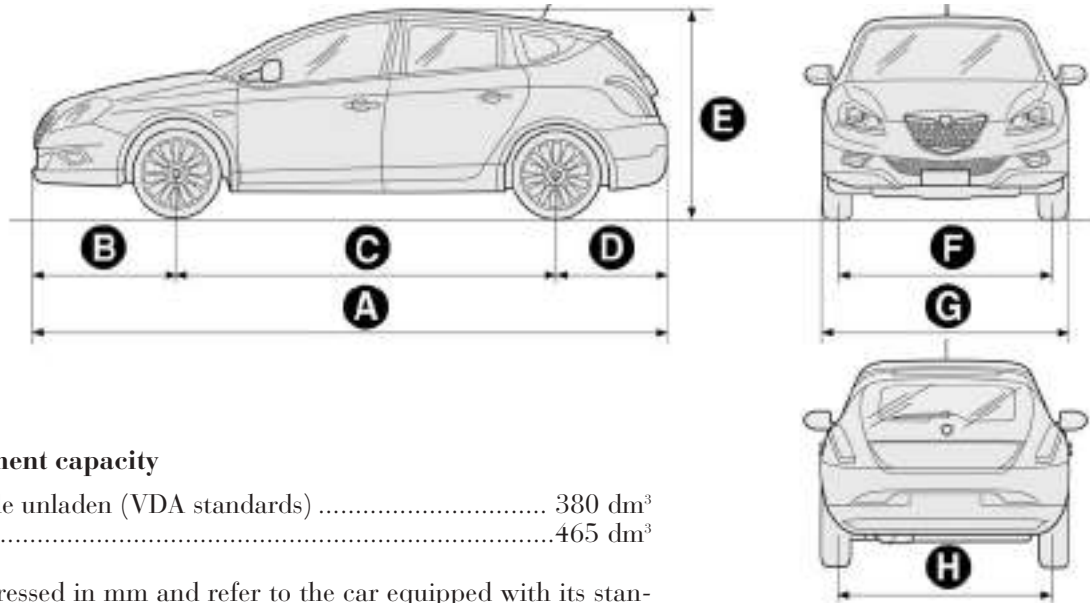

fig. 7

Luggage compartment capacity

Capacity with vehicle unladen (VDA standards) 380 dm³
 Maximum capacity 465 dm³

Dimensions are expressed in mm and refer to the car equipped with its standard-supplied tyres. Height is measured with the car unladen.

L0E0299m

A	B	C	D	E	F	G	H
4520	1017	2700	803	1499 (*)	1538	1797	1531

(*) Small variations in size are possible depending on the dimensions of the rims

PERFORMANCE

Max. allowed speeds during the initial period of usage of the car.

1.6 Multijet 105 HP: 186 km/h.

1.6 Multijet 120 HP: 194 km/h.



WEIGHTS

Weights (kg)	1.6 Multijet 105/120 HP
Unladen weight (with all fluids, fuel tank filled to 90% and without optional equipment)	1410
Payload (*) including the driver:	570
Maximum permitted loads (**)	
— front axle:	1090
— rear axle:	950
— total:	1980
Towable loads	
– braked trailer:	1300
– non-braked trailer:	500
Maximum load on roof:	80
Maximum load on the ball joint (braked trailer):	60

(*) If special equipment is fitted (sun roof, tow hook, etc.) the unladen weight increases and consequently the payload will decrease, still complying with the maximum allowed loads.

(**) Loads not to be exceeded. The user is responsible for arranging goods in the luggage compartment and/or load platform within the maximum permitted loads.

CAPACITIES

	1.6 MultiJet 105/120 HP		Prescribed fuels and original lubricants
	litres	kg	
Fuel tank: including a reserve of:	58 8/10	– –	Diesel fuel for motor vehicles (EN590 specification)
Engine cooling system:	7.1	–	Mixture of demineralised water and PARAFLU ^{UP} in 50-50 proportion (▲)
Engine sump:	4.3	3.6	SELENIA WR FORWARD
Engine sump and filter:	4.9	4.1	
Gearbox/differential casing:	1.87	1.7	TUTELA TRANSMISSION GEARFORCE
Hydraulic brake circuit with ABS:	–	0.8	TUTELA TOP 4
Windscreen/rear window washer fluid reservoir:	6	–	Water and fluid mixture TUTELA PROFESSIONAL SC 35

(▲) When the vehicle is used in particularly harsh climate conditions, we recommend using a mixture of 60% PARAFLU^{UP} and 40% distilled water.



FLUIDS AND LUBRICANTS

Your car is equipped with an engine oil that has been thoroughly developed and tested in order to meet the requirements of the Scheduled Servicing Plan. Constant use of the prescribed lubricants guarantees the fuel consumption and emission specifications. Lubricant quality is crucial for engine operation and duration.

PRODUCT SPECIFICATIONS

Usage	Fluid and lubricant specifications for a correct use of the car	Genuine fluids and lubricants	Replacement interval
Lubricant for diesel engines	Synthetic based lubricant SAE 0W-30 grade. FIAT 9.55535-DS1, ACEA C2 classification.	SELENIA WR FORWARD Contractual Technical Reference No. F842.F13	As per the Scheduled Servicing Plan

In case of emergency, if lubricants with the prescribed specifications are not available, products with the minimum indicated ACEA performance can be used for topping up; in this case optimal performance of the engine is not guaranteed.



The use of products with specifications other than those indicated above could cause damage to the engine not covered by the warranty.

Usage	Fluid and lubricant specifications for a correct use of the car	Fluids and lubricants genuine	Applications
Lubricants and greases for drive transmission	SAE 75W grade synthetic base lubricant. FIAT 9.55550-MZ6 classification	TUTELA TRANSMISSION GEARFORCE Contractual Technical Reference No. F002.F10	Gearboxes and differentials
	Grease for constant velocity joints with low friction coefficient. NL.GI. 0-1 consistency. FIAT 9.55580 classification	TUTELA STAR 700 Contractual Technical Reference No. F701.C07	CV joints differential side
	Molybdenum disulphide grease, for use at high operating temperatures. NL.GI. 1-2 consistency FIAT 9.55580 classification	TUTELA ALL STAR Contractual Technical Reference No. F702.G07	CV joints wheel side
Brake fluid	Synthetic fluid for brake and clutch systems. It exceeds the specifications: FMVSS no. 116 DOT 4, ISO 4925, SAE J 1704. FIAT 9.55597 classification	TUTELA TOP 4 Contractual Technical Reference No. F001.A93	Hydraulic brakes and hydraulic clutch controls windscreen/rear window washer/wiper
Protective agent for radiators	Red protective agent with antifreeze action, based on inhibited monoethylene glycol with organic formula. Exceeds CUNA NC 956-16, ASTM D 3306 specifications.	PARAFLU ^{UP} (●) Contractual Technical Reference No. F101.M01	Cooling circuits Percentage of use: 50% water 50% PARAFLU ^{UP} (□)
Diesel fuel additive	Additive for diesel fuel, protecting Diesel engines.	TUTELA DIESEL ART Contractual Technical Reference No. F601.L06	To be mixed with diesel (25 cc per 10 litres)
Windscreen and rear window washer fluid	Mixture of spirits and surfactants. Exceeds CUNA NC 956-11 specifications. FIAT 9.55522 classification	TUTELA PROFESSIONAL SC 35 Contractual Technical Reference No. F201.D02	To be used undiluted or diluted in windscreen/rear window washer/wiper systems

(●) IMPORTANT Do not top up or mix using fluids with different specifications.

(□) When the vehicle is used in particularly harsh climate conditions, we recommend using a mixture of 60% PARAFLU^{UP} and 40% demineralised water.



FUEL CONSUMPTION

The fuel consumption values given in the table below are determined on the basis of the type-approval tests laid down by specific European Directives.

The procedures below are followed for measuring consumption:

- urban cycle: cold starting followed by driving that simulates urban use of the car;
- extra-urban cycle: frequent accelerating in all gears, simulating extra-urban use of the car; speed varies between 0 and 120 km/h;
- combined consumption: the weighting is around 37% urban cycle and 63% extra-urban cycle.

IMPORTANT The type of route, traffic situations, weather conditions, driving style, general conditions of the car, trim level/equipment/accessories, climate control system use, load, roof rack, other situations that affect air drag may lead to different fuel consumption levels than those measured.

FUEL CONSUMPTION ACCORDING TO THE CURRENT EUROPEAN DIRECTIVE (litres x 100 km)

	1.6 Multijet 105 HP	1.6 Multijet 120 HP
Urban	5.5	5.6
Extra-urban	3.7	3.8
Combined	4.4	4.5

CO₂ EMISSIONS

The CO₂ emission refer to combined consumption.

CO₂ EMISSIONS ACCORDING TO THE CURRENT EUROPEAN DIRECTIVE

1.6 Multijet 105 HP: 115 km/h

1.6 Multijet 120 HP: 117 km/h



PRESCRIPTIONS FOR HANDLING THE VEHICLE AT THE END OF ITS LIFE

Lancia has been committed for many years to safeguarding the environment through the constant improvement of its production processes and manufacturing products that are increasingly compatible with the ecosystem. To assure customers of the best possible service in terms of respecting environmental laws and in response to European Directive 2000/53/EC governing vehicles at the end of their life, Lancia is offering their customers the opportunity of handing over their vehicle* at the end of its life without incurring any additional costs.

The European Directive sets out that when the vehicle is handed over, the last keeper or owner should not incur any expenses as a result of it having a zero or negative market value. In particular, in almost all European Union countries, until 1 January 2007, vehicles registered after 1 July 2002 will be collected free of charge, whilst from 2007 collection will be free of charge irrespective of the year of registration as long as the vehicle contains its basic components (in particular, the engine and bodywork) and has no additional waste.

To hand your vehicle over at the end of its life without extra cost, go to one of our Lancia Dealerships or authorised collection and scrapping centres. These centres have been carefully chosen to offer high quality service for the collection, treatment and recycling of vehicles at their end of life, respecting the surrounding environment.

You can find further information on these collection and scrapping centres either from a Lancia Dealership or by calling the freephone number 00800 526242 00 or on the Lancia website.

* Vehicle for transporting passengers with a maximum of nine seats with a total permitted weight of 3.5 t

PETRONAS
SELENIA
MOTOR OIL

In the heart of your engine.



Always ask your mechanic for **PETRONAS**
SELENIA
MOTOR OIL

Oil change? The experts recommend Petronas Selenia

*The engine of your car is factory filled with **Petronas Selenia**,
This is an engine oil range which satisfies the most advanced
international specifications. Its superior technical characteristics
allow **Petronas Selenia** to guarantee the **highest performance
and protection of your engine.***

The Petronas Selenia range includes a number of technologically advanced products:

SELENIA K PURE ENERGY

Fully synthetic lubricant designed for latest generation, low emission, petrol engines. Its specific formulation warrants the utmost protection also for high performance turbocharged engines with high thermal stress. Its low ash content helps to maintain the total cleanliness of modern catalysts.

SELENIA WR PURE ENERGY

Fully synthetic lubricant that can meet the requirements of the latest diesel engines. Low ash content to protect the particulate filter from the residual products of combustion. High Fuel Economy System that allows considerable fuel saving.
It reduces the danger of dirtying the turbine to ensure the protection of increasingly high performance diesel engines.

SELENIA MULTIPower GAS PURE ENERGY

Fully-synthetic lubricant designed for petrol engines also turbocharged, powered with methane or LPG. Its exclusive formulation improves valve protection against wear, neutralises the acid compounds formed by combustion and keeps engine performance levels unchanged.

SELENIA K POWER

Fully synthetic lubricant developed for American design petrol engines, specially formulated to allow an excellent resistance to oxidation and high level fuel economy. Excellent protection at high temperatures.

SELENIA DIGITEK PURE ENERGY

Fully synthetic lubricant for petrol engines. High fuel economy characteristics. Specific formulation for the TwinAir two-cylinder engines. Selenia Digitech Pure Energy allows maximum protection of the engine even under high mechanical stress caused by severe stop and go conditions of city traffic.

The range also includes Selenia K, Selenia 20K, Selenia Turbo Diesel, Selenia Sport, Selenia Sport Power, Selenia Racing.

For further information on Petronas Selenia products visit the web site www.pt-petronas.eu

blank page

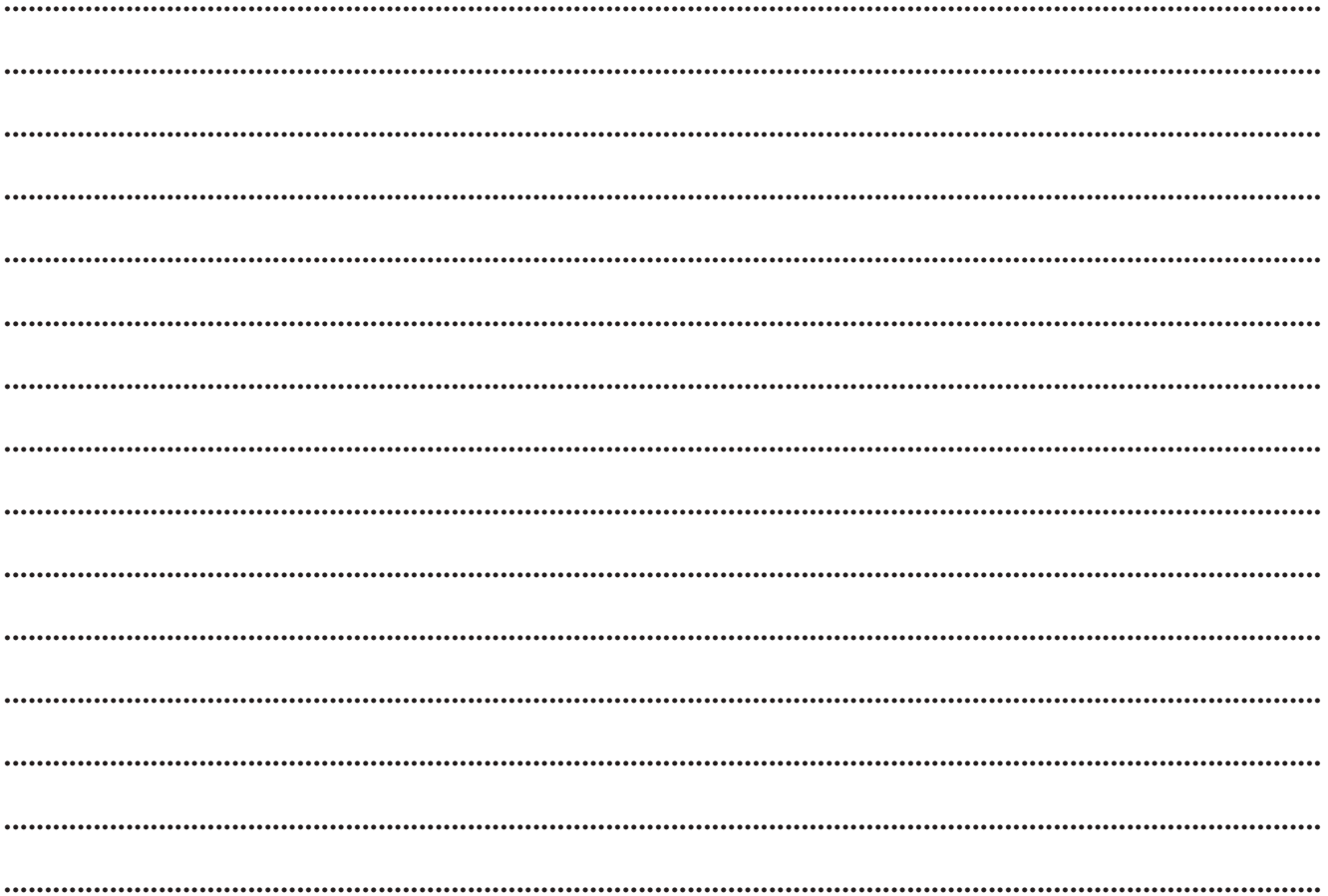



ABS	121	Battery recharging	230	Cigar lighter	85
Accessories purchased by the owner	149	Battery		Climate comfort.....	58
Advanced ESP system.....	117	– jump starting	196	CO ₂ emissions	276
AFS (adaptive lights)	79-106	– recharging	230	Code Card	44
Air cleaner/Pollen filter/ Diesel filter	243	– replacement	244	Control panel and on-board instruments	9
Airbag		Bodywork	252	Controls.....	77
– front	173	– bodywork versions	260	Cornering lights	68
– side.....	178	Bonnet.....	102	Courtesy lights.....	75
Alarm.....	48	Brakes	263	Courtesy mirror light (bulb replacement)	222
Ashtray.....	86	Bulb (replacement)	210	Cruise Control	73
ASR (system)	119	Capacities	272	Dimensions	269
Assisted parking		Car inactivity.....	193	Dipped beam headlights (control)	69
(Magic Parking)	134	Carrying children safely	161	– bulb replacement	214
Automatic dual zone climate control system.....	61	Central locking	90	Direction indicators	
Automatic Fix&Go kit	198	Changing a wheel	203	– bulb replacement	216
Automatic headlight sensor (dusk sensor).....	68	Checking levels.....	239	– control.....	69
		Child restraint systems (suitability for use)	167		
		Child safety lock	90		

Display	26	Engine codes/ Bodywork versions.....	260	Fuel cap	151
Door locking.....	89	Engine compartment (washing)	255	Fuel consumption	275
Doors	89	Engine.....	261	Fuel cut-off	80
– child safety lock	90	EOBD (system).....	124	Fuel supply system	262
– passenger side front door and rear door emergency locking device.....	91	External lights	67	Fuses (replacement).....	223
Driving Advisor (system)	110	F itting the “Universal” child restraint system	163	G ear Shift Indicator (GSI)	28
Driving Advisor	110	Fix&Go Automatic (kit).....	198	Gearbox (use).....	188
DRL (Daytime Running Lights)	67	Flashing	69	Glove compartment light (bulb replacement)	222
DST (Dynamic Steering Torque) ...	107	Fluids and lubricants	273	Glove compartment	84
Dualdrive (electric power steering system)	77-125	Fog lights.....	68-79	H andbrake.....	187
E lectric windows	91	- bulb replacement.....	217	Hazard warning lights	78
End of vehicle life	277	Follow Me Home (device)	70	Head restraints	55
		Front headlights (cleaning).....	255	Headlights	105
		Front roof lights (bulb replacement)	219	Hill Holder (system)	118
		Front/rear armrest.....	81-83	I dentification data.....	258
				Ignition device	51



In an emergency	195	Main beam headlights (control)	69	– Magic Parking (Assisted parking)	134
Instrument panel	8	– bulb replacement	215	Parking	187
Interior fittings	81	Maintenance and care	233	Particulate filter (DPF)	153
Interiors	256	– demanding use of the car	237	Performance	270
“Isofix” (child restraint system setup)	169	– periodic checks	237	Power socket	85
“Isofix” child restraint systems (fitting setup)	169	– Scheduled Servicing Plan	235	Pretensioners	158
Keys	44	– scheduled servicing	234	Protecting the environment	152
Knowing your car	7	Manual climate control system	59	Radio (system setup)	148
Lancia CODE (sistema)	43	Maximum speeds	270	Radio transmitters and mobile phones	150
Lifting the car	231	Menu items	30	Rain sensor	72
Lubricants (specifications)	273	MSR (system)	119	Reactive Suspension System	109
Luggage compartment light (bulb replacement)	221	Number plate lights (bulb replacement)	218	Rear fog light	79
Luggage compartment	96	Paint	253	– bulb replacement	217
Magic Parking	134	Parking sensors	131	Rear roof lights (bulb replacement)	220
				Rear view mirrors	56

Rear window wiper	SBR system.....	157	– Reactive Suspension
– blades	Seat belts.....	156	System.....
– control.....	Seats	52	Symbols.....
– nozzles.....	– cleaning.....	256	T echnical specifications.....
Refuelling.....	Side bags.....	178	The keys.....
Remote control (key)	Side lights.....	69	Third brake light
Replacing a bulb.....	– bulb replacement	216	(bulb replacement)
Replacing a wheel.....	Snow chains	193	Towing the car.....
Replacing an exterior bulb	Sport (function).....	77	Towing trailers.....
Replacing an interior bulb	SPORT function	107	TPMS.....
Replacing fuses.....	Starting and driving.....	183	Transmission
Reversing light	Starting the engine.....	184-196	Trip Computer.....
(bulb replacement)	Steering lock.....	51	TTC system.....
Rim Protector (tyres)	Steering wheel	56	Tyres
Roof rack/ski rack	Steering	263	– inflation pressure
Rubber hoses	Sun roof	86	– replacement
S afe Lock (device)	Sun visors.....	81	– Rim Protector
Safety.....	Suspension	263	– snow tyres.....
Saving fuel			– standard tyres provided



- understanding tyre marking.....	264	Windscreen wiper	
		- blades	249-250
		- control	70
		- nozzles.....	251
Using the gearbox	188	Windscreen/rear	
		window washer	70-71
Weights	271		
Wheel rims			
- understanding rim marking.....	266		
Wheels and tyres	247		
Wheels	264		
- understanding tyre marking.....	256		
Window bag	178		
Window cleaning	70		
Windows (cleaning)	255		



The data contained in this publication is intended merely as a guide. Lancia reserves the right to modify the models and versions described in this booklet at any time for technical and commercial reasons. If you have any further questions please consult your Lancia dealer.
Printed in recycled paper without chlorine.